

IGBT MODULE (N-series)

600V / 100A (7 in one-package)

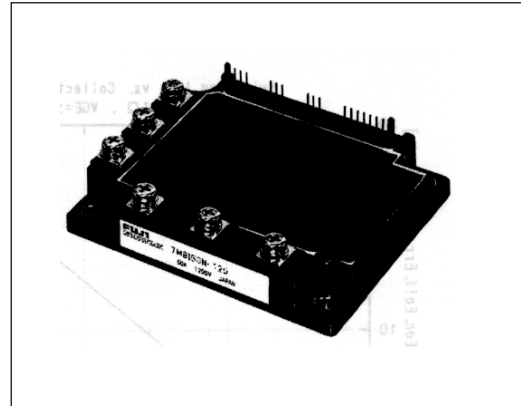

■ Features

- High Speed Switching
- Voltage Drive
- Low Inductance Module Structure
- Dynamic Brake Circuit

■ Applications

- Inverter for Motor Drive
- AC and DC Servo Drive Amplifier
- Uninterruptible Power Supply

■ Maximum ratings and characteristics

● Absolute maximum ratings (Tc=25°C unless without specified)

Item	Symbol	Condition	Rating	Unit	
Inverter(IGBT)	Collector-Emitter voltage	V _{CEs}	600	V	
	Gate-Emitter voltage	V _{GEs}	±20	V	
	Collector current	DC	I _c	100	A
		1ms	I _{cP}	200	A
		DC	-I _c	100	A
Collector power dissipation 1 device	P _c		400	W	
Brake(IGBT+FWD)	Collector-Emitter voltage	V _{CEs}	600	V	
	Gate-Emitter voltage	V _{GEs}	±20	V	
	Collector current	DC	I _c	50	A
		1ms	I _{cP}	100	A
	Collector power dissipation 1 device	P _c		200	W
	Repetitive peak reverse voltage	V _{RRM}		600	V
	Average forward current	I _{F(AV)}		1	A
Surge current	I _{FSM}	10ms	50	A	
Operating junction temperature	T _j		+150	°C	
Storage temperature	T _{stg}		-40 to +125	°C	
Isolation voltage	V _{iso}	AC : 1 minute	AC 2500	V	
Mounting screw torque	Mounting*1		3.5	N·m	
	Terminal*1		3.5		

*1 Recommendable value : 2.5 to 3.5 N·m

● Electrical characteristics (Tj=25°C unless without specified)

Item	Symbol	Condition	Characteristics			Unit		
			Min.	Typ.	Max.			
Inverter (IGBT)	Zero gate voltage collector current	ICES	Tj=25°C, VCE=600V, VGE=0V			3.0	mA	
	Gate-Emitter leakage current	IGES	VCE=0V, VGE=±20V			15	µA	
	Gate-Emitter threshold voltage	VGE(th)	VCE=20V, IC=100mA			4.5	7.5	V
	Collector-Emitter saturation voltage	VCE(sat)	VGE=15V, IC=100A			2.8	V	
	Collector-Emitter voltage	-VCE	-IC=100A			3.0	V	
	Input capacitance	Cies	VGE=0V, VCE=10V, f=1MHz			6600	pF	
	Switching time	ton	VCC=300V			1.2	µs	
		toff	IC=100A			1.5	µs	
tr		VGE=±15V, RG=24 ohm			0.35	µs		
Reverse recovery time of FRD	trr	IF=100A, VGE=-10V, -di/dt=300A/µs			300	ns		
Brake (IGBT)	Zero gate voltage collector current	ICES	VCE=600V, VGE=0V			1.0	mA	
	Gate-Emitter leakage current	IGES	VCE=0V, VGE=±20V			100	nA	
	Collector-Emitter saturation voltage	VCE(sat)	IC=50A, VGE=15V			2.8	V	
	Switching time	ton	VCC=300V			1.2	µs	
		toff	IC=50A			1.5	µs	
tr		VGE=±15V, RG=51ohm			0.35	µs		
Brake (FWD)	Reverse current	IRRM	VR=VRRM			1.0	mA	
	Reverse recovery time	trr				600	ns	

● Thermal Characteristics

Item	Symbol	Condition	Characteristics			Unit
			Min.	Typ.	Max.	
Thermal resistance (1 device)	Rth(j-c)	Inverter IGBT			0.31	°C/W
		Inverter FRD			0.90	
		Brake IGBT			0.63	
Contact thermal resistance *	Rth(c-f)	With thermal compound		0.05		

* This is the value which is defined mounting on the additional cooling fin with thermal compound

■ Equivalent Circuit Schematic

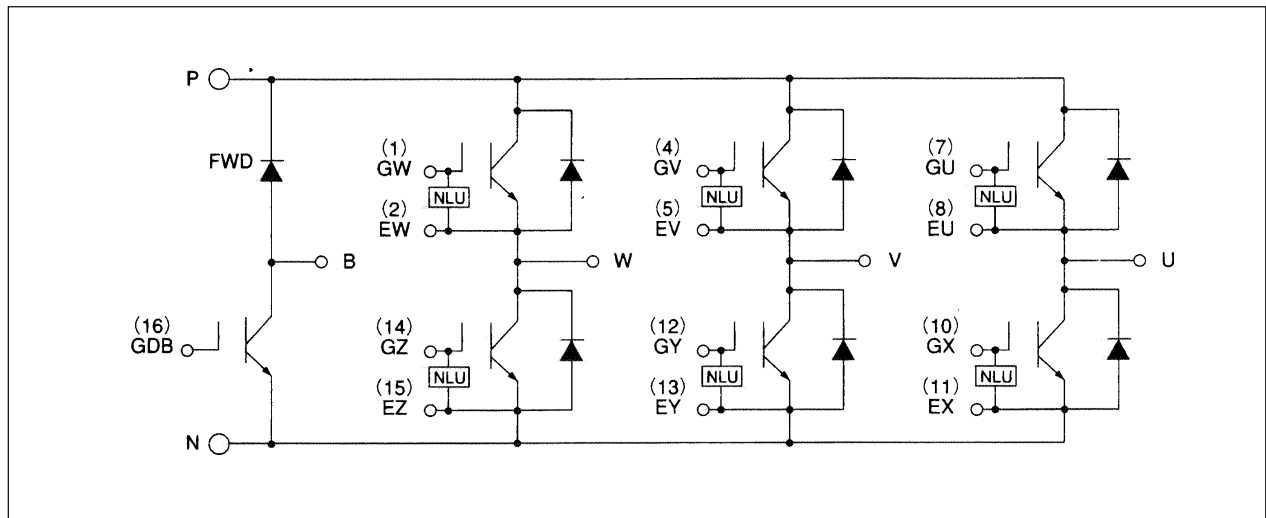

■ Characteristics (Representative)

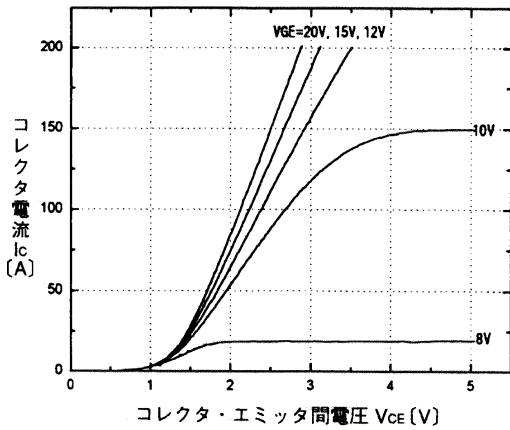

コレクタ電流-コレクタ・エミッタ間電圧特性 ($T_j=25^\circ\text{C}$) <INV部>
Collector current vs. Collector-Emitter voltage <INV>

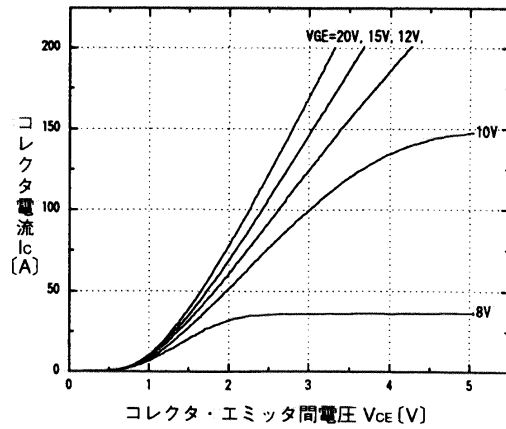

コレクタ電流-コレクタ・エミッタ間電圧特性 ($T_j=125^\circ\text{C}$) <INV部>
Collector current vs. Collector-Emitter voltage <INV>

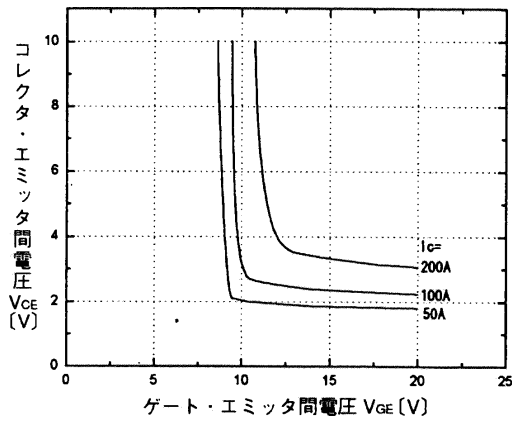

コレクタ・エミッタ間電圧-ゲート・エミッタ間電圧特性 ($T_j=25^\circ\text{C}$) <INV部>
Collector-Emitter voltage vs. Gate-Emitter voltage <INV>

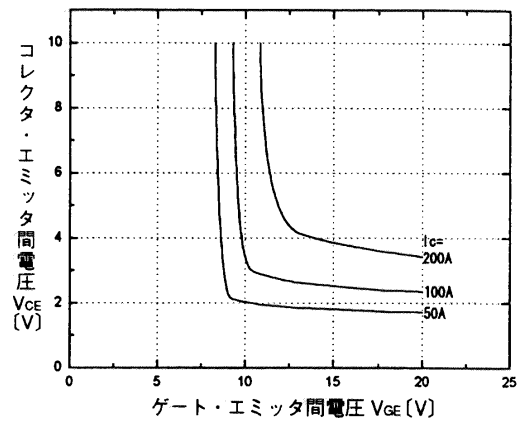

コレクタ・エミッタ間電圧-ゲート・エミッタ間電圧特性 ($T_j=125^\circ\text{C}$) <INV部>
Collector-Emitter voltage vs. Gate-Emitter voltage <INV>

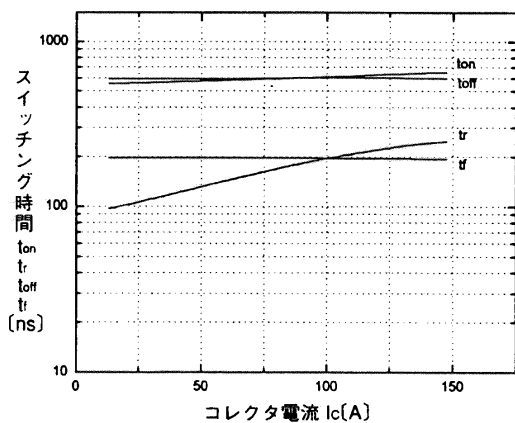

スイッチング時間-コレクタ電流特性 ($T_j=25^\circ\text{C}$) <INV部>
Switching time vs. Collector current <INV>

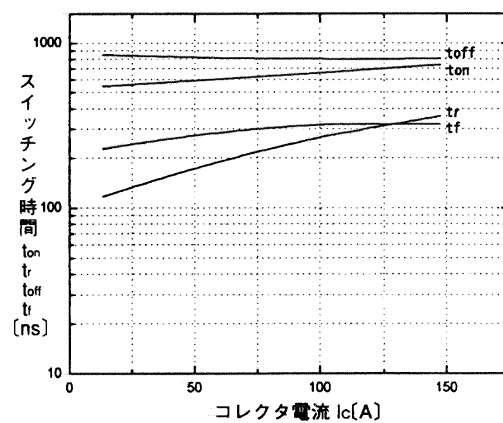

スイッチング時間-コレクタ電流特性 ($T_j=125^\circ\text{C}$) <INV部>
Switching time vs. Collector current <INV>

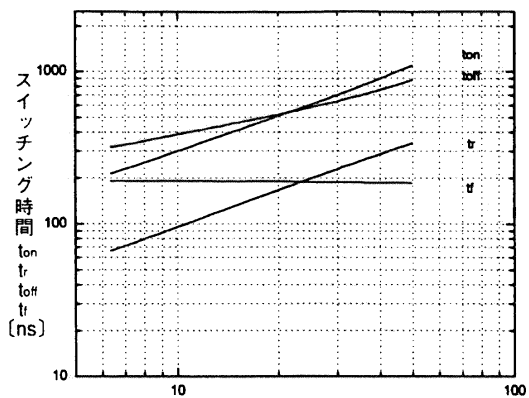

ゲート抵抗 R_g (Ω)
 スイッチング時間-ゲート抵抗特性 ($T_j=25^\circ\text{C}$) <INV部>
 Switching time vs. Gate resistance <INV>

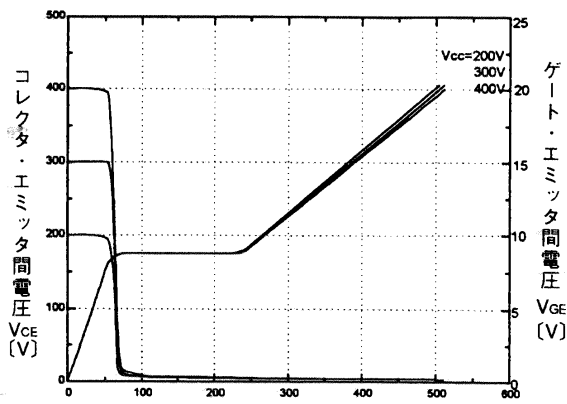

コレクタ・エミッタ間電圧 V_{ce} (V)
 ゲート・エミッタ間電圧 V_{ge} (V)
 充電電荷量 Q_g (nC)
 ダイナミック入力特性 ($T_j=25^\circ\text{C}$) <INV部>
 Dynamic input characteristic <INV>

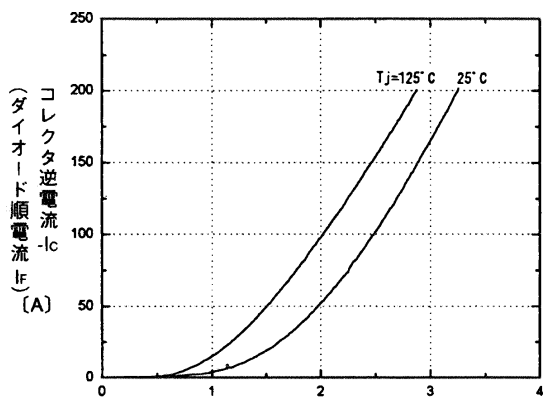

コレクタ逆電流 $-I_c$
 (ダイオード順電流 I_F) (A)
 $T_j=125^\circ\text{C}$ 25°C
 エミッタ・コレクタ間電圧 V_{ceD} (V)
 (ダイオード順電圧 V_F)
 高速フリーホイールダイオード順電圧特性 <INV部>
 Forward voltage of free wheel diode <INV>

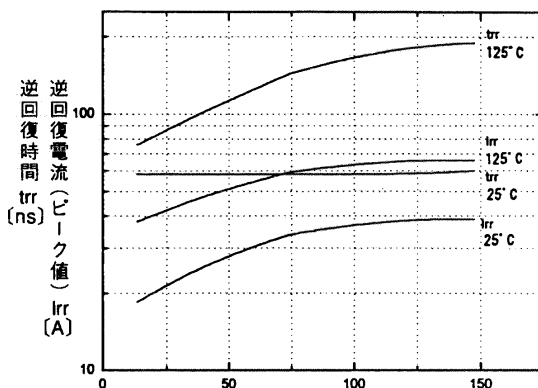

逆回復時間 t_{rr} (ns)
 逆回復電流 (ピーク値) I_{rr} (A)
 t_{rr} I_{rr} 特性 <INV部>
 t_{rr} , I_{rr} <INV>

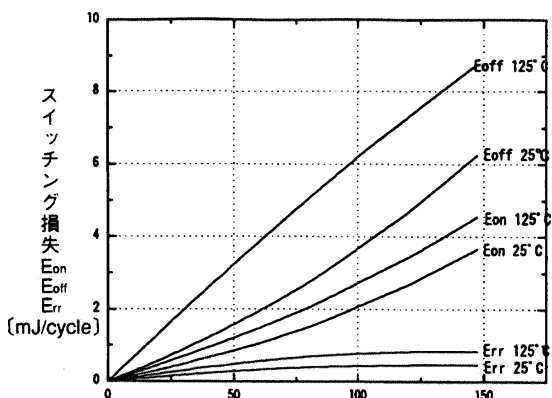

スイッチング損失 E_{on} , E_{off} , E_{err} (mJ/cycle)
 E_{on} E_{off} E_{err}
 $T_j=125^\circ\text{C}$ 25°C
 コレクタ電流 I_c (A)
 スイッチング損失-コレクタ電流特性 <INV部>
 Switching loss vs. Collector current <INV>

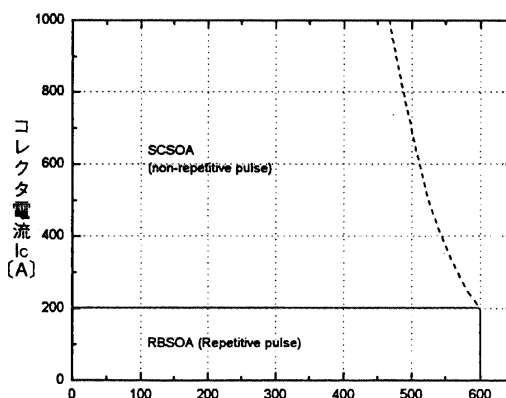

コレクタ電流 I_c (A)
 コレクタ・エミッタ間電圧 V_{ce} (V)
 SCSOA (non-repetitive pulse)
 RBSOA (Repetitive pulse)
 安全動作領域(逆バイアス) ($T_j \leq 125^\circ\text{C}$) <INV部>
 Reverse biased safe operating area <INV>

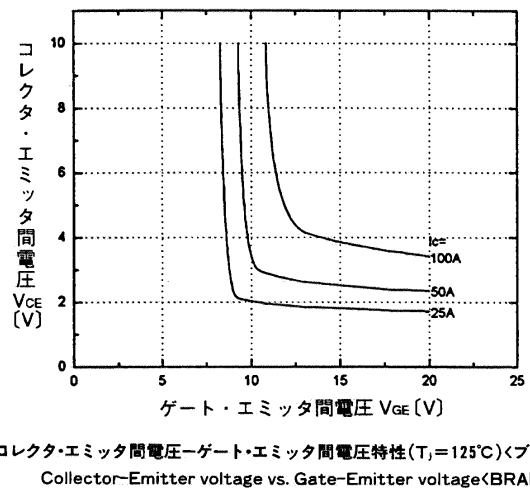
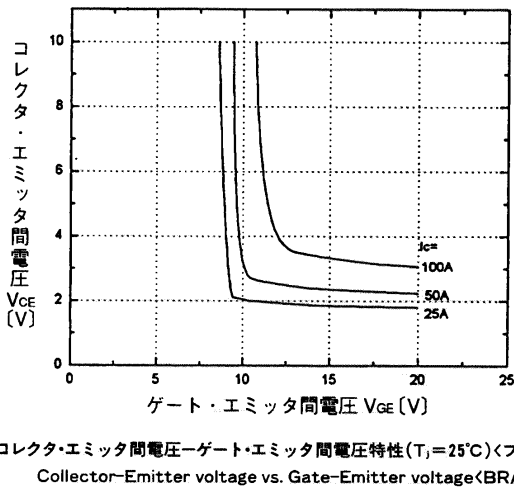
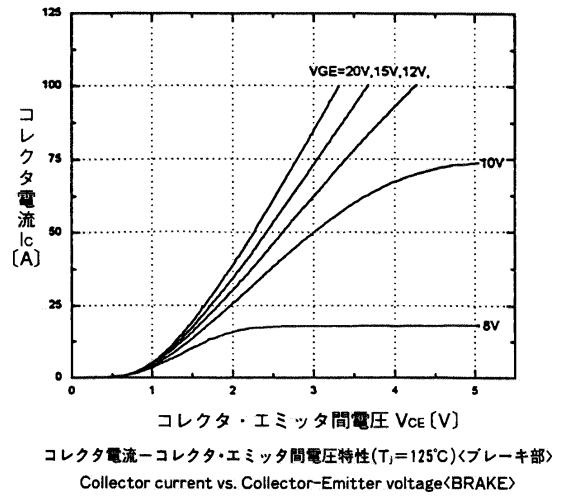
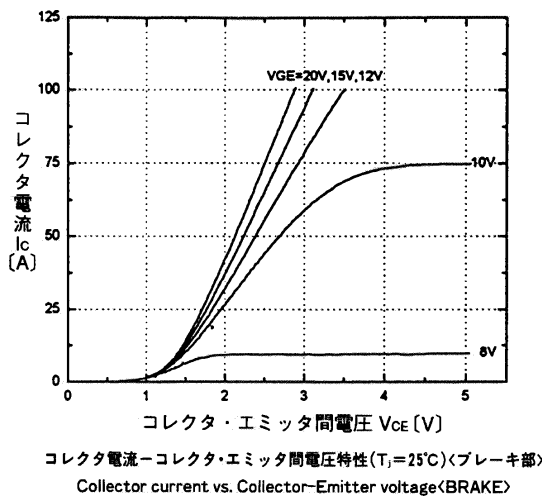
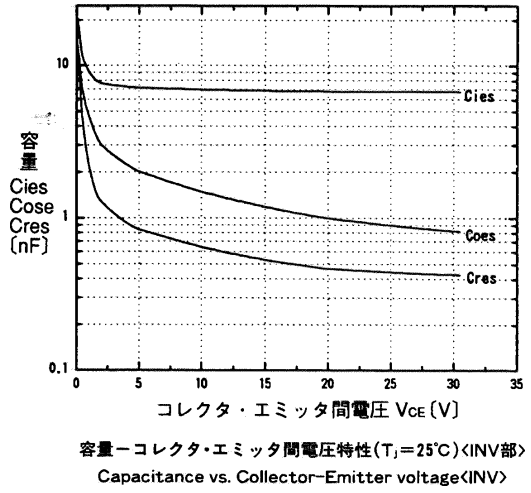
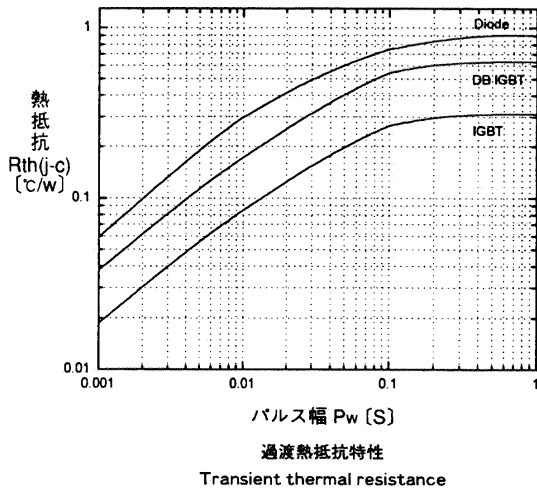

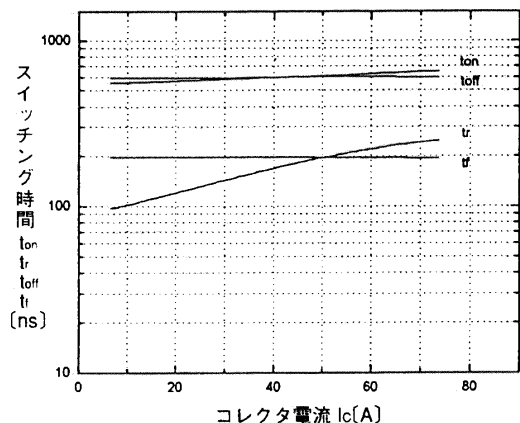

スイッチング時間-コレクタ電流特性 ($T_j=25^\circ\text{C}$) <ブレーキ部>
Switching time vs. Collector current <BRAKE>

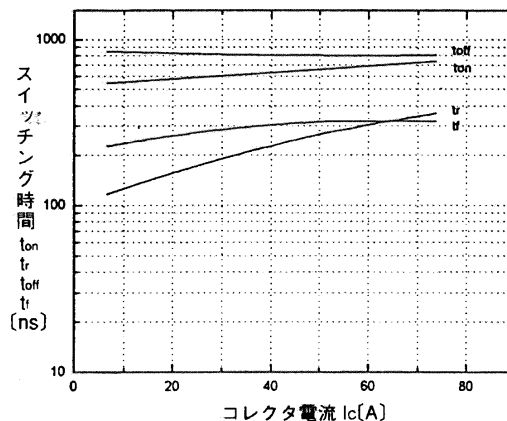

スイッチング時間-コレクタ電流特性 ($T_j=125^\circ\text{C}$) <ブレーキ部>
Switching time vs. Collector current <BRAKE>

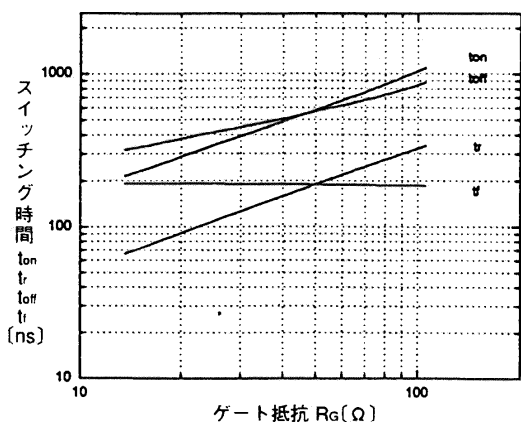

スイッチング時間-ゲート抵抗特性 ($T_j=25^\circ\text{C}$) <ブレーキ部>
Switching time vs. Gate resistance <BRAKE>

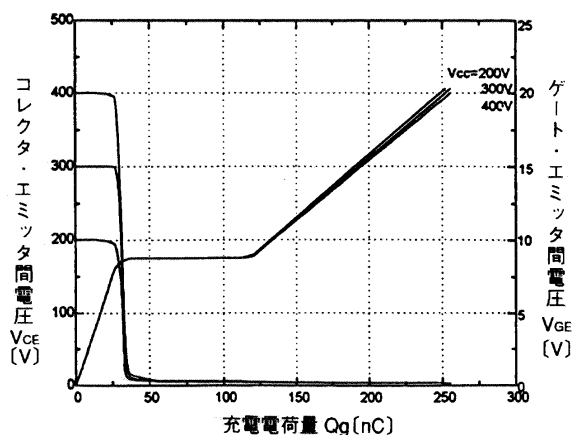

ダイナミック入力特性 ($T_j=25^\circ\text{C}$) <ブレーキ部>
Dynamic input characteristic <BRAKE>

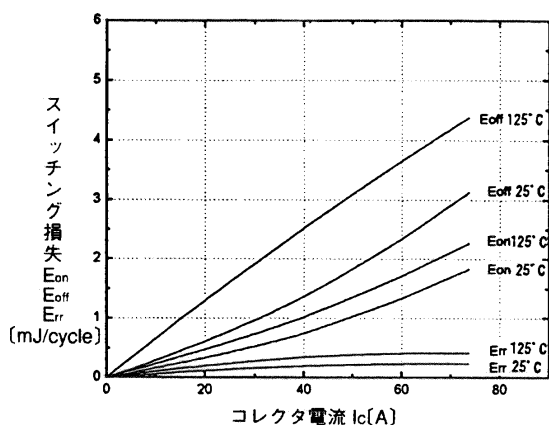

スイッチング損失-コレクタ電流特性 <ブレーキ部>
Switching loss vs. Collector current <BRAKE>

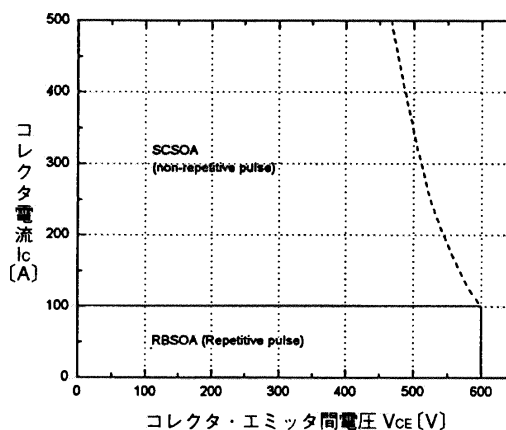

安全動作領域(逆バイアス) ($T_j \leq 125^\circ\text{C}$) <ブレーキ部>
Reverse biased safe operating area <BRAKE>

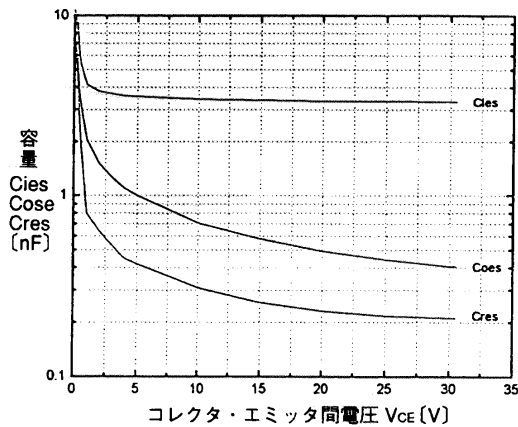

容量-コレクタ・エミッタ間電圧特性 (Tj=25°C) <ブレーキ部>
 Capacitance vs. Collector-Emitter voltage <BRAKE>

■ Outline Drawings, mm

