

# 2MBI150NB-120

IGBT Module

1200V / 150A 2 in one-package

## ■ Features

- High speed switching
- Voltage drive
- Low inductance module structure

## ■ Applications

- Inverter for Motor drive
- AC and DC Servo drive amplifier
- Uninterruptible power supply
- Industrial machines, such as Welding machines



## ■ Maximum ratings and characteristics

### ● Absolute maximum ratings (at Tc=25°C unless otherwise specified)

Item	Symbol	Rating	Unit
Collector-Emitter voltage	V <sub>CES</sub>	1200	V
Gate-Emitter voltage	V <sub>GES</sub>	±20	V
Collector current	Continuous	I <sub>c</sub>	150 A
	1ms	I <sub>c</sub> pulse	300 A
	Continuous	-I <sub>c</sub>	150 A
	1ms	-I <sub>c</sub> pulse	300 A
Max. power dissipation	P <sub>c</sub>	1100	W
Operating temperature	T <sub>j</sub>	+150	°C
Storage temperature	T <sub>stg</sub>	-40 to +125	°C
Isolation voltage	V <sub>is</sub>	AC 2500 (1min.)	V
Screw torque	Mounting *1	3.5	N·m
	Terminals *2	4.5	N·m

\*1: Recommendable value : 2.5 to 3.5 N·m(M5) or (M6)

\*2: Recommendable value : 3.5 to 4.5 N·m(M6)

### ■ Equivalent Circuit Schematic

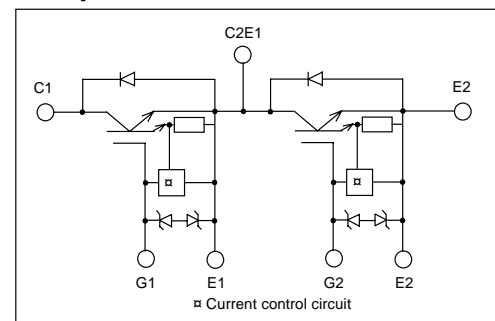

### ● Electrical characteristics (at Tj=25°C unless otherwise specified)

Item	Symbol	Characteristics			Conditions	Unit
		Min.	Typ.	Max.		
Zero gate voltage collector current	I <sub>CES</sub>	-	-	2.0	V <sub>GE</sub> =0V, V <sub>CES</sub> =1200V	mA
Gate-Emitter leakage current	I <sub>GES</sub>	-	-	30	V <sub>CES</sub> =0V, V <sub>GE</sub> =±20V	μA
Gate-Emitter threshold voltage	V <sub>GE(th)</sub>	4.5	-	7.5	V <sub>CES</sub> =20V, I <sub>c</sub> =150mA	V
Collector-Emitter saturation voltage	V <sub>CES(sat)</sub>	-	-	3.3	V <sub>GE</sub> =15V, I <sub>c</sub> =150A	V
Input capacitance	C <sub>ies</sub>	-	24000	-	V <sub>GE</sub> =0V	pF
Output capacitance	C <sub>oes</sub>	-	8700	-	V <sub>CES</sub> =10V	
Reverse transfer capacitance	C <sub>res</sub>	-	7740	-	f=1MHz	
Turn-on time	t <sub>on</sub>	-	0.65	1.2	V <sub>CC</sub> =600V	μs
	t <sub>r</sub>	-	0.25	0.6	I <sub>c</sub> =150A	
Turn-off time	t <sub>off</sub>	-	0.85	1.5	V <sub>GE</sub> =±15V	μs
	t <sub>f</sub>	-	0.35	0.5	R <sub>G</sub> =5.6 ohm	
Diode forward on voltage	V <sub>F</sub>	-	-	3.0	I <sub>F</sub> =150A, V <sub>GE</sub> =0V	V
Reverse recovery time	t <sub>rr</sub>	-	-	0.35	I <sub>F</sub> =150A	μs

### ● Thermal resistance characteristics

Item	Symbol	Characteristics			Conditions	Unit
		Min.	Typ.	Max.		
Thermal resistance	R <sub>th(j-c)</sub>	-	-	0.11	IGBT	°C/W
	R <sub>th(j-c)</sub>	-	-	0.18	Diode	°C/W
	R <sub>th(c-f)*3</sub>	-	0.025	-	the base to cooling fin	°C/W

\*3: This is the value which is defined mounting on the additional cooling fin with thermal compound

■ Characteristics (Representative)

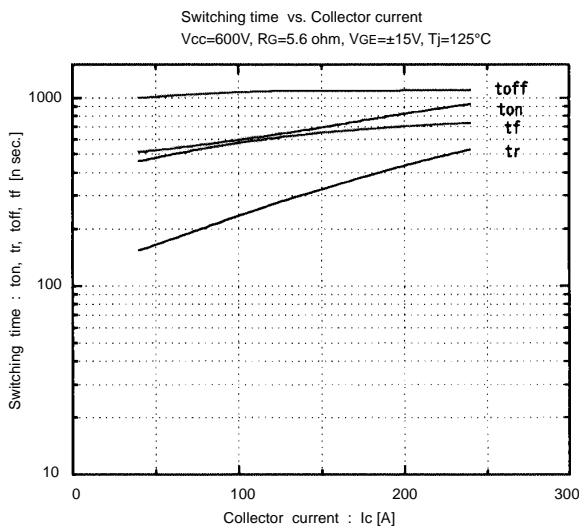
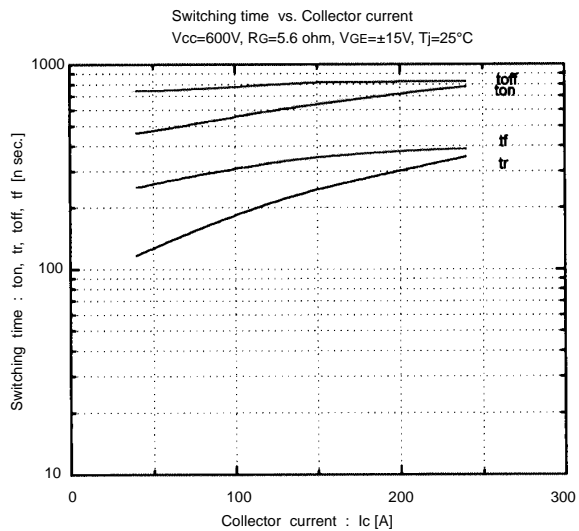
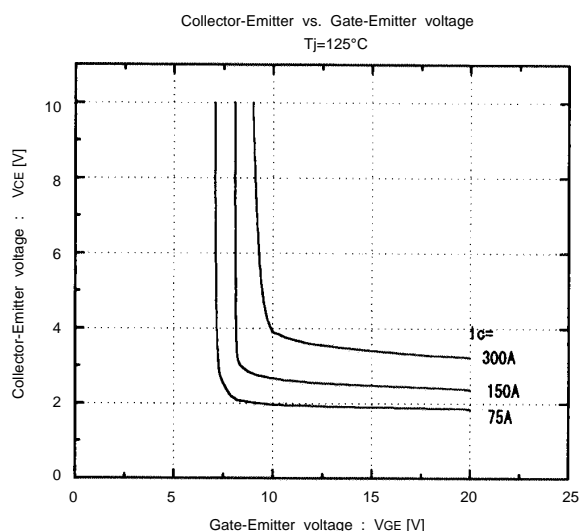
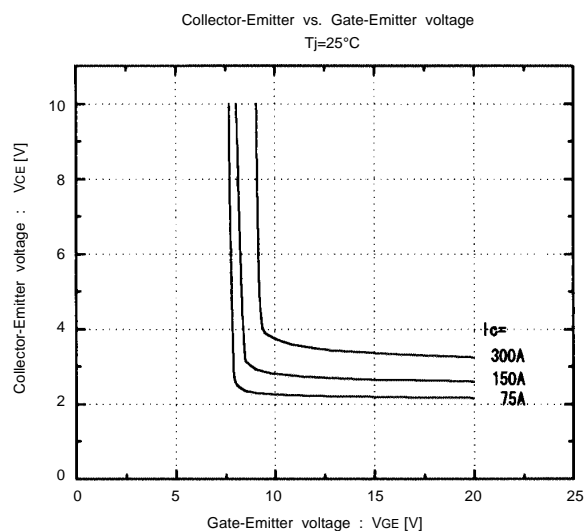
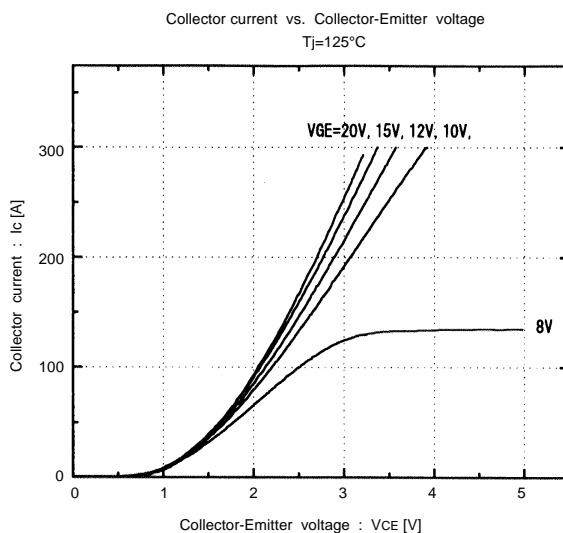
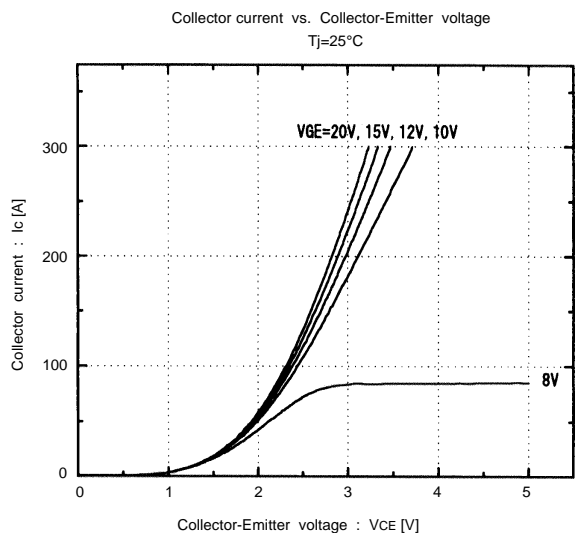

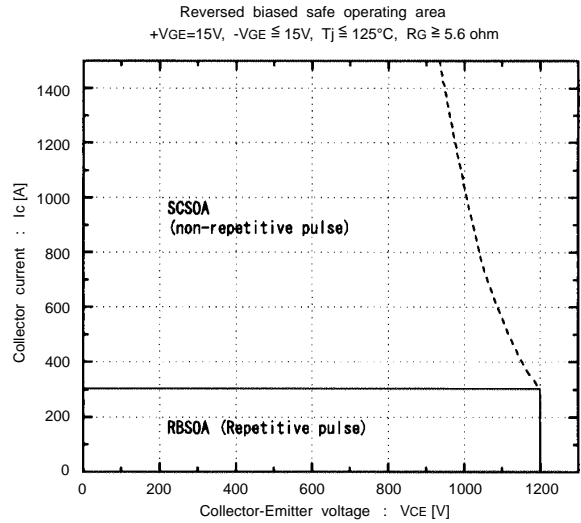
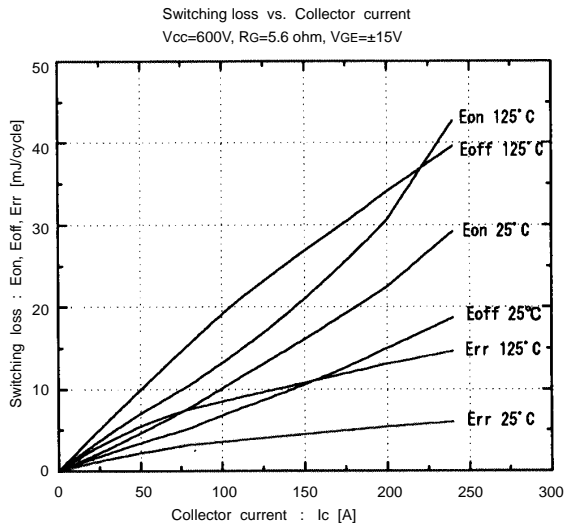
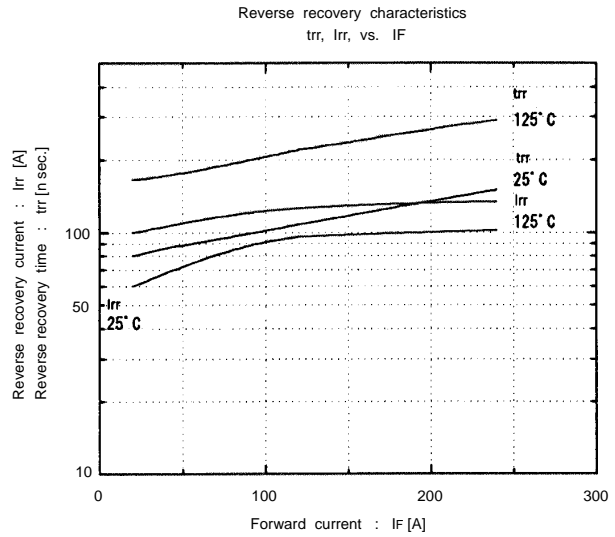
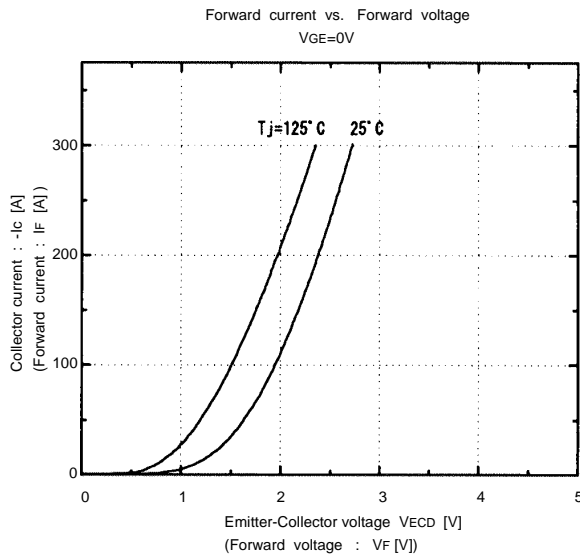
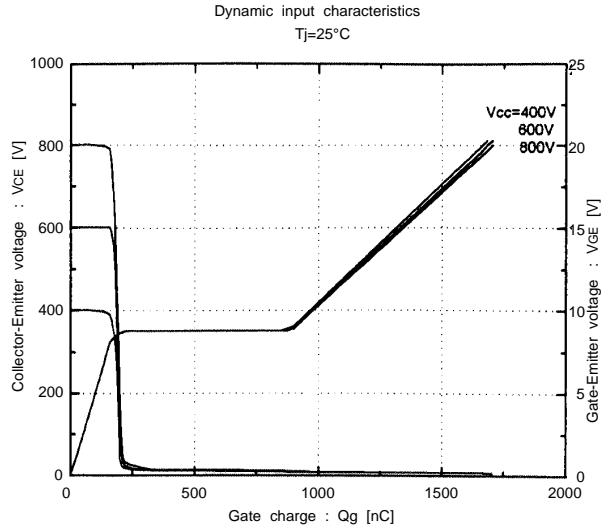
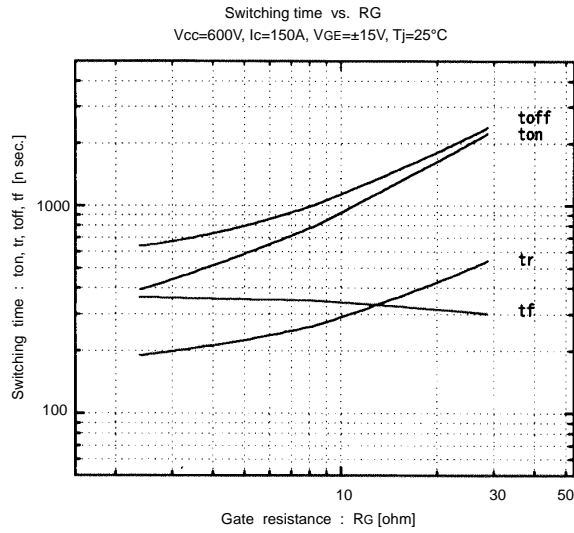

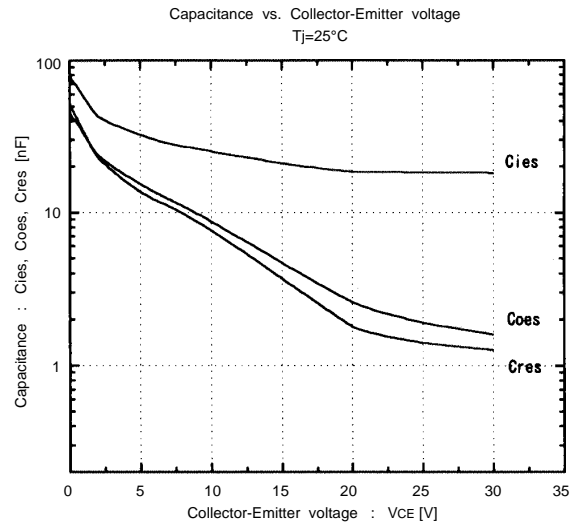
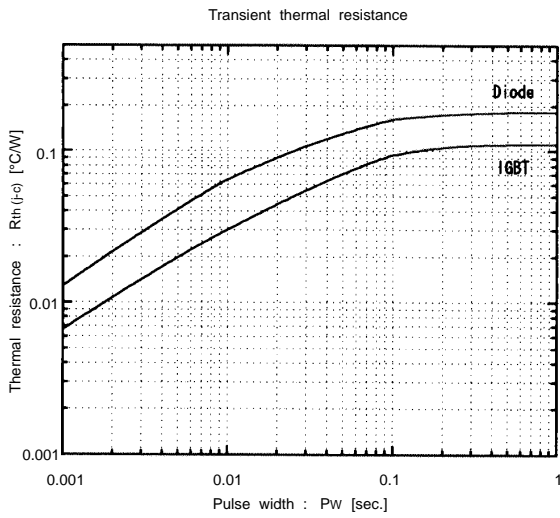

■ Outline Drawings, mm

