

2MBI50N-060

IGBT Module

600V / 50A 2 in one-package

■ Features

- High speed switching
- Voltage drive
- Low inductance module structure

■ Applications

- Inverter for Motor drive
- AC and DC Servo drive amplifier
- Uninterruptible power supply
- Industrial machines, such as Welding machines



■ Maximum ratings and characteristics

● Absolute maximum ratings (at $T_c=25^\circ\text{C}$ unless otherwise specified)

Item	Symbol	Rating	Unit
Collector-Emitter voltage	V_{CES}	600	V
Gate-Emitter voltage	V_{GES}	± 20	V
Collector current	Continuous	I_c	50 A
	1ms	I_c pulse	100 A
	Continuous	$-I_c$	50 A
	1ms	$-I_c$ pulse	100 A
Max. power dissipation	P_c	250	W
Operating temperature	T_j	+150	$^\circ\text{C}$
Storage temperature	T_{stg}	-40 to +125	$^\circ\text{C}$
Isolation voltage	V_{is}	AC 2500 (1min.)	V
Screw torque	Mounting *1	3.5	N·m
	Terminals *1	3.5	N·m

*1: Recommendable value : 2.5 to 3.5 N·m(M5)

■ Equivalent Circuit Schematic

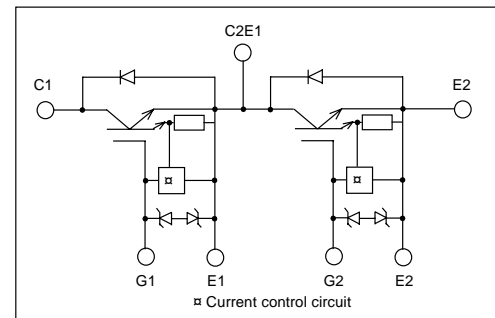

● Electrical characteristics (at $T_j=25^\circ\text{C}$ unless otherwise specified)

Item	Symbol	Characteristics			Conditions	Unit
		Min.	Typ.	Max.		
Zero gate voltage collector current	I_{CES}	-	-	1.0	$V_{GE}=0V, V_{CE}=600V$	mA
Gate-Emitter leakage current	I_{GES}	-	-	15	$V_{CE}=0V, V_{GE}=\pm 20V$	μA
Gate-Emitter threshold voltage	$V_{GE(th)}$	4.5	-	7.5	$V_{CE}=20V, I_c=50\text{mA}$	V
Collector-Emitter saturation voltage	$V_{CE(sat)}$	-	-	2.8	$V_{GE}=15V, I_c=50A$	V
Input capacitance	C_{ies}	-	3300	-	$V_{GE}=0V$	pF
Output capacitance	C_{oes}	-	730	-	$V_{CE}=10V$	
Reverse transfer capacitance	C_{res}	-	330	-	$f=1\text{MHz}$	
Turn-on time	t_{on}	-	0.6	1.2	$V_{CC}=300V$	μs
	t_r	-	0.2	0.6	$I_c=50A$	
Turn-off time	t_{off}	-	0.6	1.0	$V_{GE}=\pm 15V$	
	t_f	-	0.2	0.35	$R_G=51\text{ohm}$	
Diode forward on voltage	V_F	-	-	3.0	$I_F=50A, V_{GE}=0V$	V
Reverse recovery time	t_{rr}	-	-	0.3	$I_F=50A$	μs

● Thermal resistance characteristics

Item	Symbol	Characteristics			Conditions	Unit
		Min.	Typ.	Max.		
Thermal resistance	$R_{th(j-c)}$	-	-	0.5	IGBT	$^\circ\text{C/W}$
	$R_{th(j-c)}$	-	-	1.33	Diode	$^\circ\text{C/W}$
	$R_{th(c-f)}^*2$	-	0.05	-	the base to cooling fin	$^\circ\text{C/W}$

*2: This is the value which is defined mounting on the additional cooling fin with thermal compound

■ Characteristics (Representative)

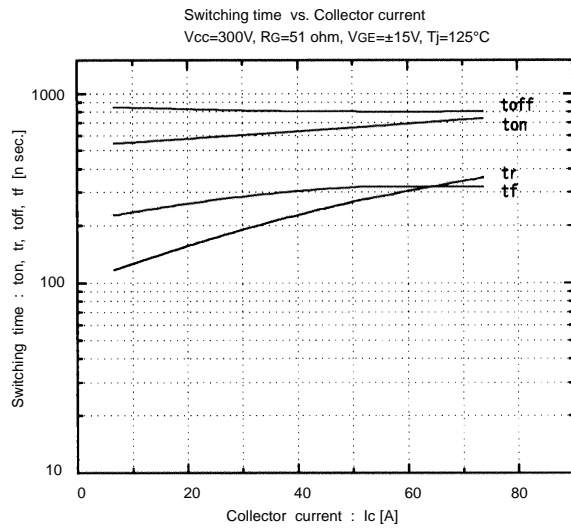
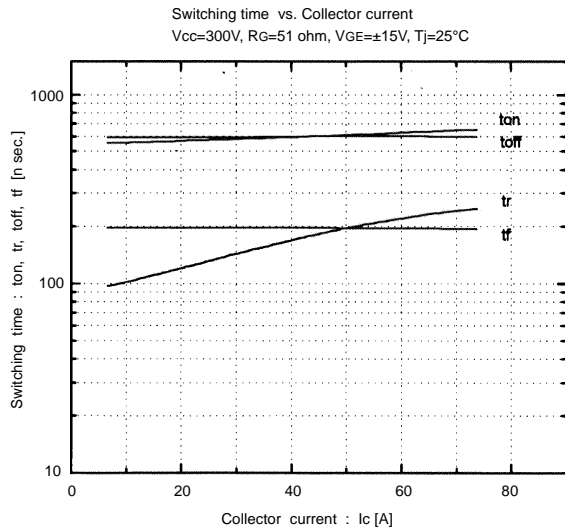
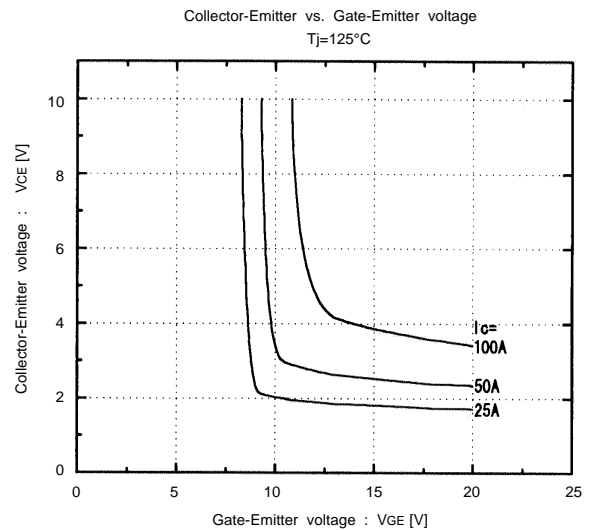
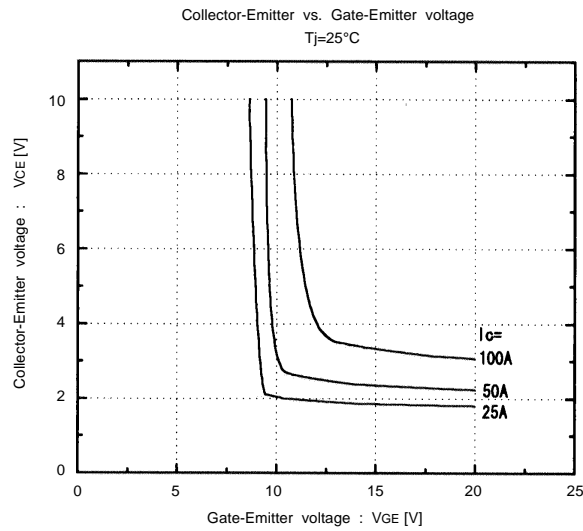
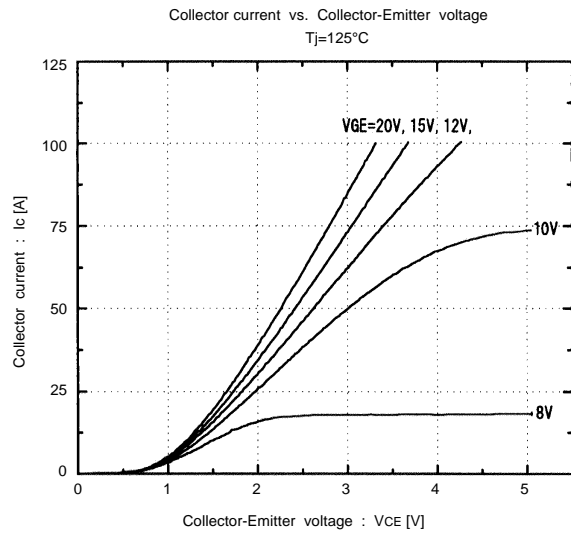
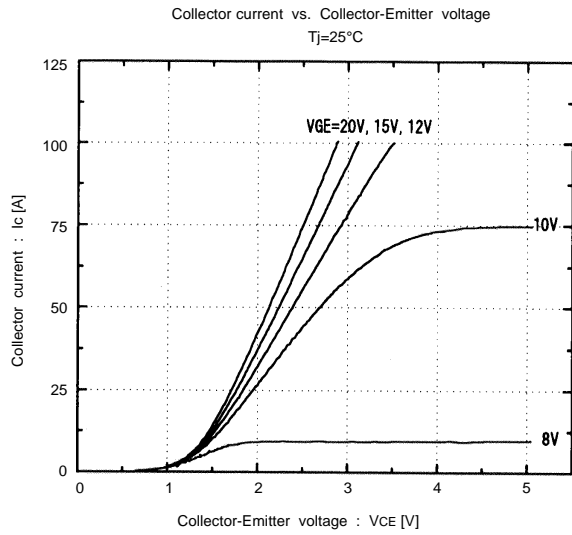

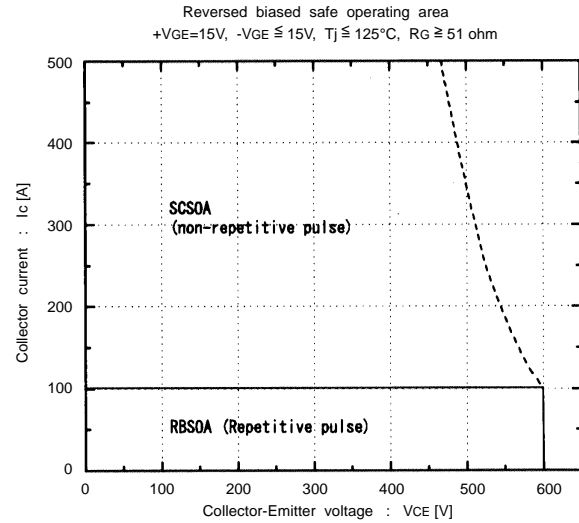
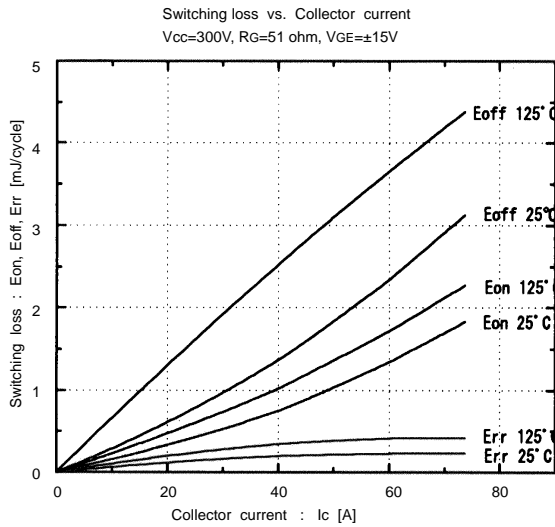
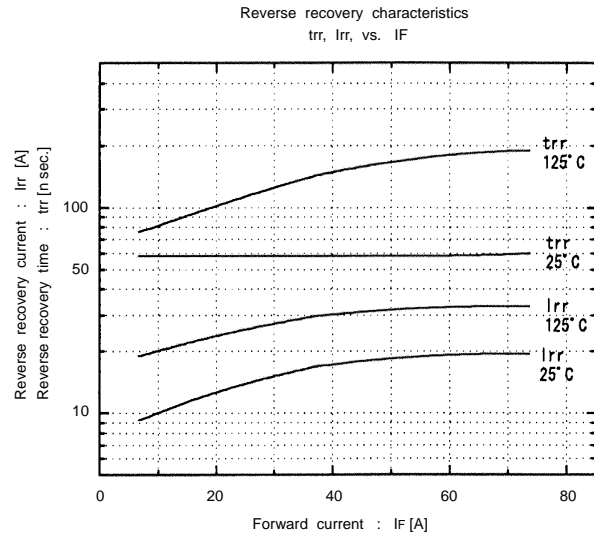
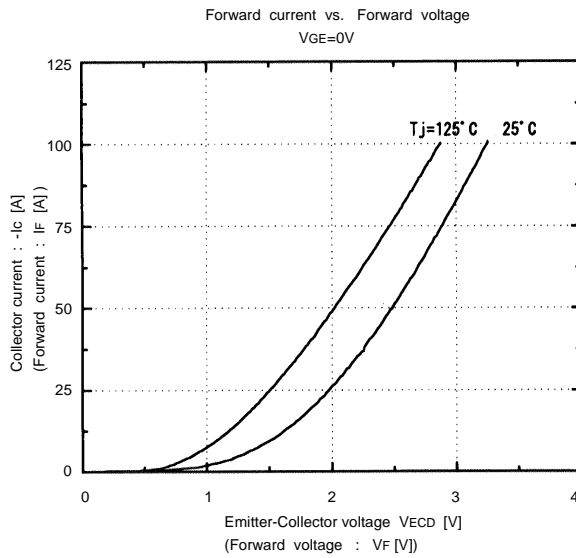
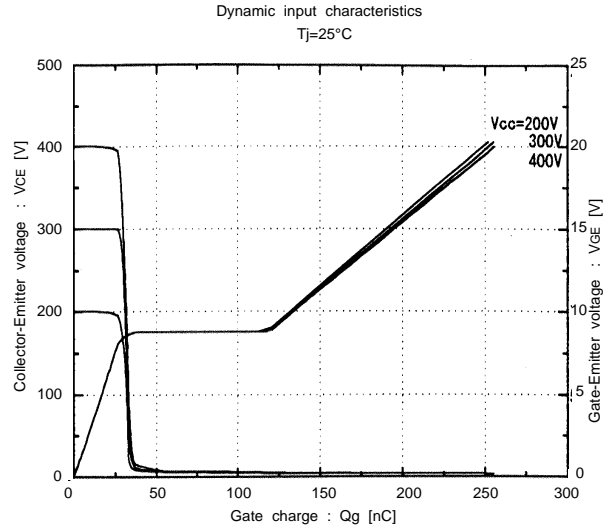
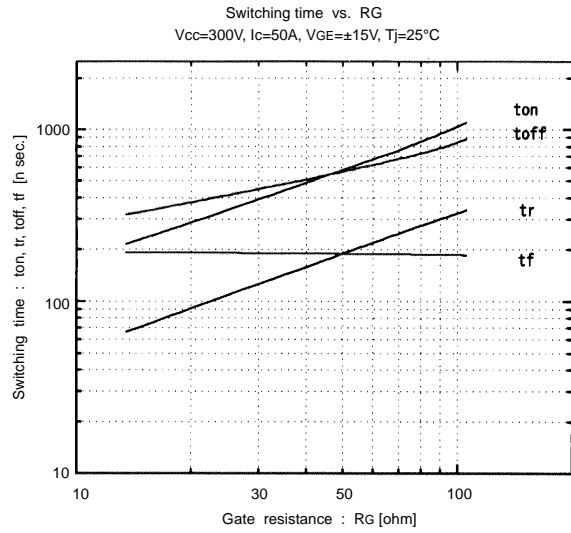

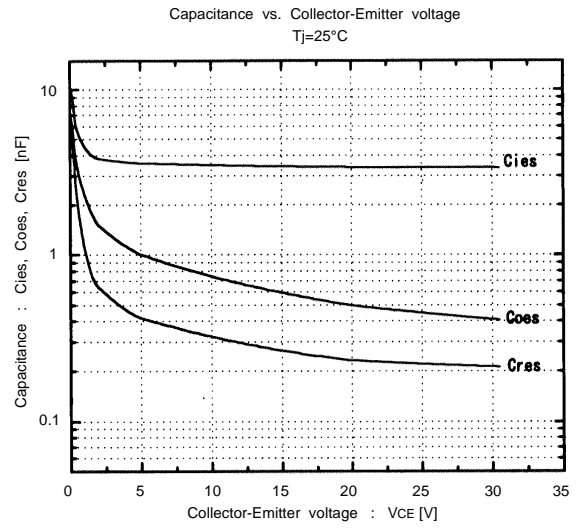
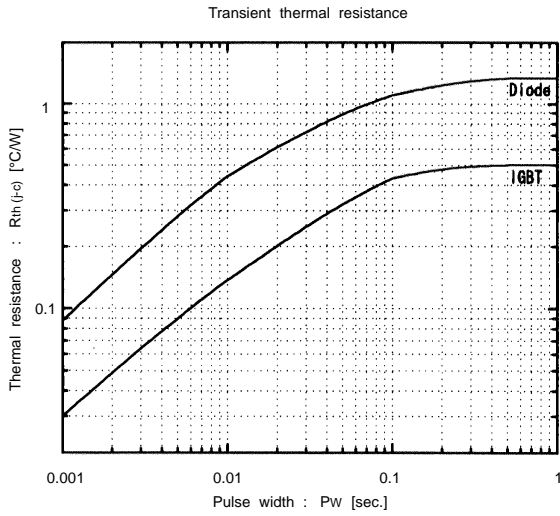

■ Outline Drawings, mm

