

# MOSFET MODULE

# FCA50CC50



UL:E76102(M)

**FCA50CC50** is a dual power MOSFET module designed for fast switching applications of high voltage and current. (2 devices are serial connected with a fast recovery diode ( $t_{rr} \leq 100\text{ns}$ ) reverse connected across each MOSFET.) The mounting base of the module is electrically isolated from semiconductor elements for simple heatsink construction.

- $I_D = 50\text{A}$ ,  $V_{DS} = 500\text{V}$
- Suitable for high speed switching applications.
- Low ON resistance.
- Wide Safe Operating Areas.
- $t_{rr} \leq 100\text{ns}$  fast recovery diode for free wheel.

(Applications)

UPS(CVCF), Motor Control, Switching Power Supply, etc.

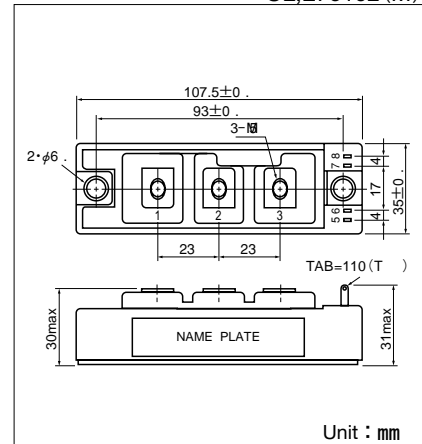
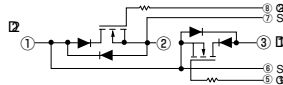

Unit : mm

## Maximum Ratings

( $T_j = 25^\circ\text{C}$  u n l )

Symbol	Item		Conditions	Ratings			Unit
				FCA50CC50			
$V_{DS}$	Drain-Source Voltage			500			V
$V_{GS}$	Gate-Source Voltage			$\pm 20$			V
$I_D$	Drain Current	DC	Duty 55%	50			A
$I_{DP}$		Pulse		100			
$-I_D$	Source Current			50			A
$P_T$	Total Power Dissipation		$T_c = 25^\circ\text{C}$	330			W
$T_j$	Channel Temperature			$-40$ t $+150$			$^\circ\text{C}$
$T_{stg}$	Storage Temperature			$-40$ t $+125$			$^\circ\text{C}$
$V_{iso}$	Isolation Voltage (R.M.S.)		A.C. 1minute	2500			V
	Mounting Torque	Mounting (M6)	Recommended Value 2.5-3.9 (25-40)	4.7 (48)			N·m (kgf·cm)
		Terminal (M5)	Recommended Value 1.5-2.5 (15-25)	2.7 (28)			
	Mass		Typical Value	240			g

## Electrical Characteristics

( $T_j = 25^\circ\text{C}$  u n l )

Symbol	Item		Conditions	Ratings			Unit
				Min.	Typ.	Max.	
$I_{GSS}$	Gate Leakage Current		$V_{GS} = \pm 20\text{V}$ , $V_{DS} = 0\text{V}$			$\pm 1.0$	$\mu\text{A}$
$I_{DSS}$	Zero Gate Voltage Drain Current		$V_{GS} = 0\text{V}$ , $V_{DS} = 500\text{V}$			1.0	mA
$V_{(BR)DS}$	Drain-Source Breakdown Voltage		$V_{GS} = 0\text{V}$ , $I_D = 1\text{mA}$	500			V
$V_{GS(th)}$	Gate-Source Threshold Voltage		$V_{DS} = V_{GS}$ , $I_D = 10\text{mA}$	1.0		5.0	V
$R_{DS(on)}$	Drain-Source On-State Resistance		$I_D = 25\text{A}$ , $V_{GS} = 15\text{V}$			140	m $\Omega$
$V_{DS(on)}$	Drain-Source On-State Voltage		$I_D = 25\text{A}$ , $V_{GS} = 15\text{V}$			3.5	V
$g_{fs}$	Forward Transconductance		$V_{DS} = 10\text{V}$ , $I_D = 25\text{A}$		30		S
$C_{iss}$	Input Capacitance		$V_{GS} = 0\text{V}$ , $V_{DS} = 25\text{V}$ , $f = 1.0\text{MHz}$			10000	pF
$C_{oss}$	Output Capacitance		$V_{GS} = 0\text{V}$ , $V_{DS} = 25\text{V}$ , $f = 1.0\text{MHz}$			1900	pF
$C_{rss}$	Reverse Transfer Capacitance		$V_{GS} = 0\text{V}$ , $V_{DS} = 25\text{V}$ , $f = 1.0\text{MHz}$			750	pF
$t_{d(on)}$	Switching Time	Turn-on Delay Time	$V_{DD} = 300\text{V}$ , $V_{GS} = 15\text{V}$ $I_D = 25\text{A}$ , $R_G = 5\Omega$		60		ns
$t_r$		Rise Time			100		
$t_{d(off)}$		Turn-off Delay Time			520		
$t_f$		Fall Time			140		
$V_{SDS}$	Diode Forward Voltage		$I_S = 25\text{A}$ , $V_{GS} = 0\text{V}$			2.0	V
$t_{rr}$	Reverse Recovery Time		$I_S = 25\text{A}$ , $V_{GS} = -5\text{V}$ , $di/dt = 100\text{A}/\mu\text{s}$		80	100	ns
$R_{th(j-c)}$	Thermal Resistance		MOSFET			0.38	$^\circ\text{C}/\text{W}$
			Diode			1.67	

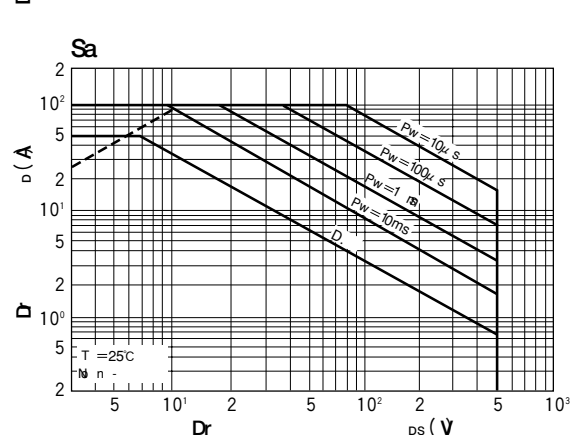
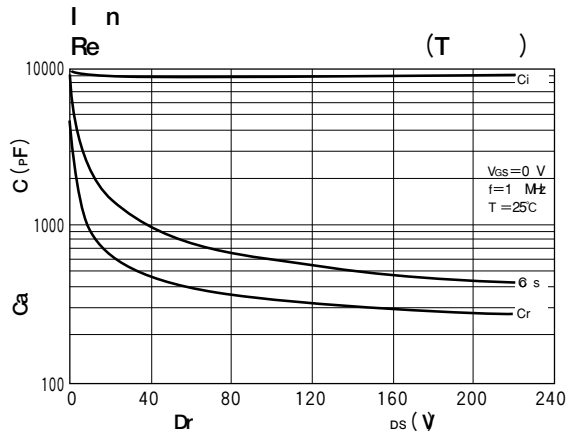
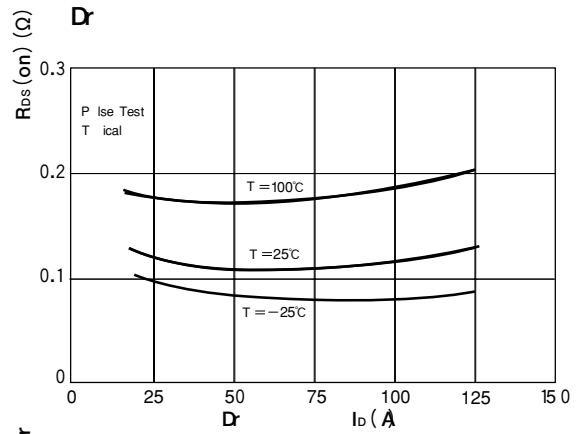
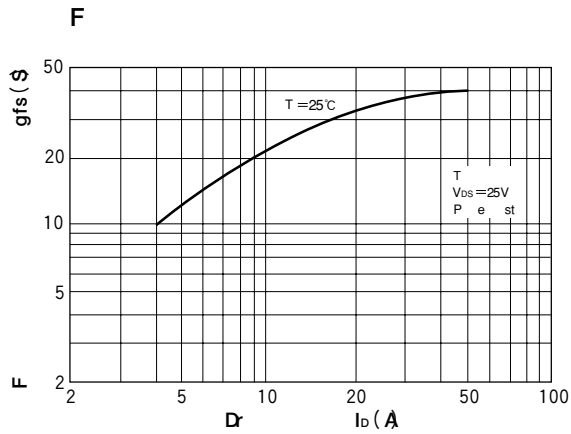
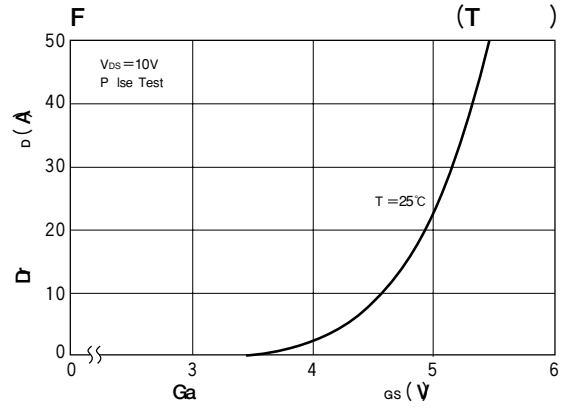
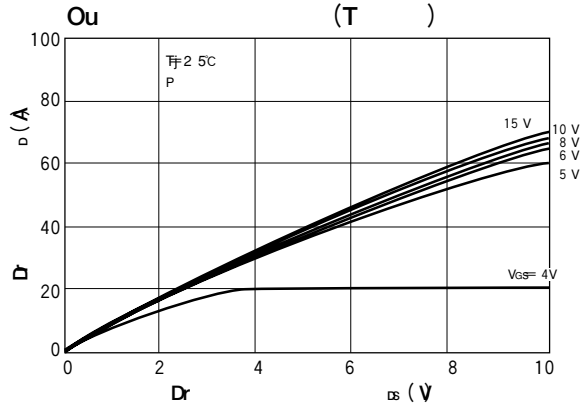

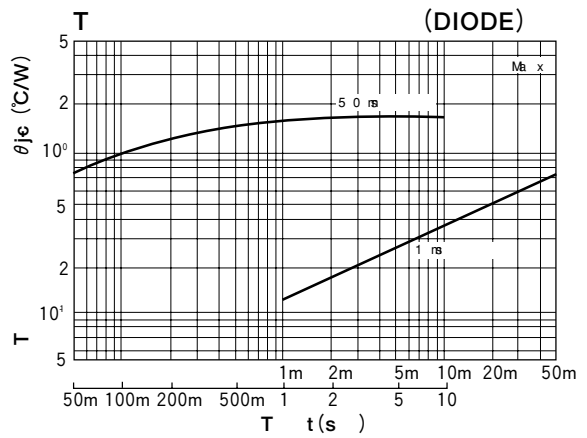
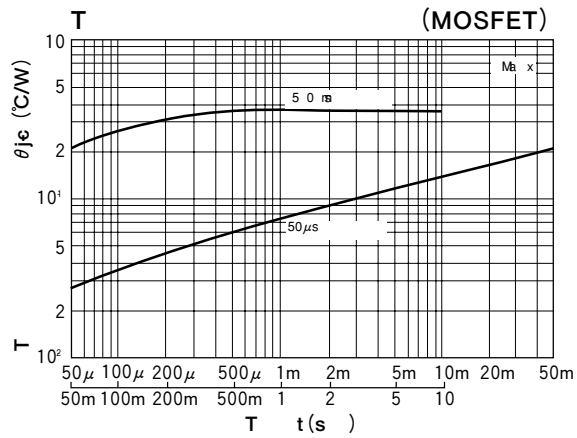
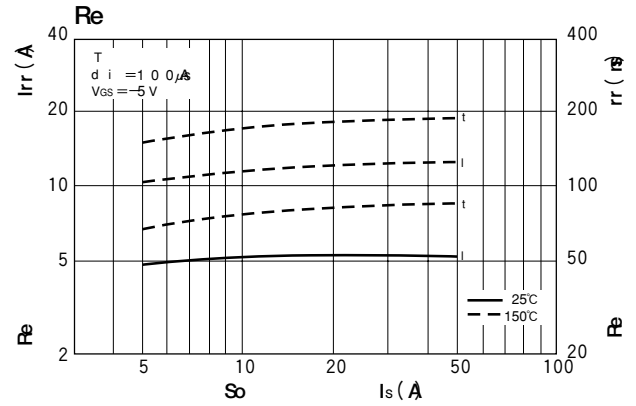
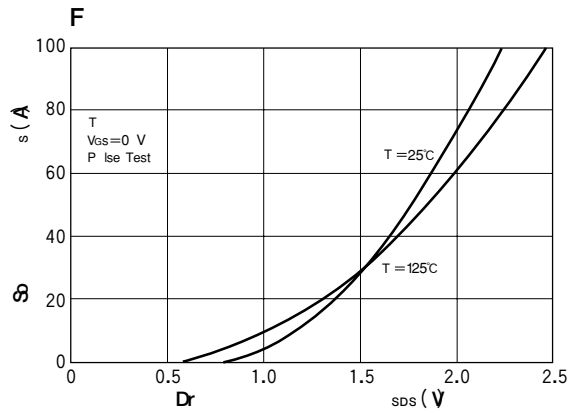

# MOSFET MODULE

# FCA75CC50



UL;E76102(M)

**FCA75CC50** is a dual power MOSFET module designed for fast switching applications of high voltage and current. (2 devices are serial connected with a fast recovery diode ( $t_{rr} \leq 100\text{ns}$ ) reverse connected across each MOSFET.) The mounting base of the module is electrically isolated from semiconductor elements for simple heatsink construction.

- $I_D = 75\text{A}$ ,  $V_{DS} = 500\text{V}$
- Suitable for high speed switching applications.
- Low ON resistance.
- Wide Safe Operating Areas.
- $t_{rr} \leq 100\text{ns}$  fast recovery diode for free wheel.

**(Applications)**

UPS(CVCF), Motor Control, Switching Power Supply, etc.

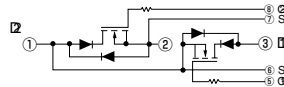
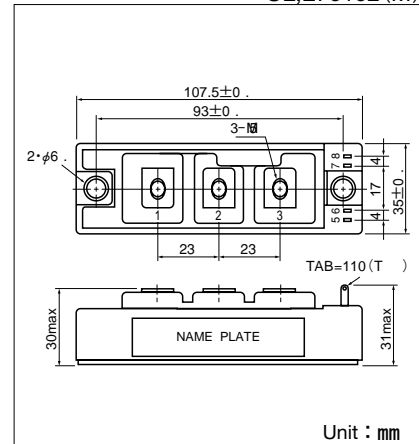

**Maximum Ratings**

( $T_j = 25^\circ\text{C}$  u n l )

Symbol	Item		Conditions	Ratings		Unit
				FCA75CC50		
$V_{DS}$	Drain-Source Voltage			500		V
$V_{GS}$	Gate-Source Voltage			$\pm 20$		V
$I_D$	Drain Current	DC	Duty 35%	75		A
$I_{DP}$		Pulse		150		
$-I_D$	Source Current			75		A
$P_T$	Total Power Dissipation		$T_c = 25^\circ\text{C}$	430		W
$T_j$	Channel Temperature			$-40$ t $+ 150$		$^\circ\text{C}$
$T_{stg}$	Storage Temperature			$-40$ t $+ 125$		$^\circ\text{C}$
$V_{iso}$	Isolation Voltage (R.M.S.)		A.C. 1minute	2500		V
	Mounting Torque	Mounting (M6)	Recommended Value 2.5-3.9 (25-40)	4.7 (48)		N·m (kgf·cm)
		Terminal (M5)	Recommended Value 1.5-2.5 (15-25)	2.7 (28)		
	Mass		Typical Value	240		g

**Electrical Characteristics**

( $T_j = 25^\circ\text{C}$ )

Symbol	Item		Conditions	Ratings			Unit
				Min.	Typ.	Max.	
$I_{GSS}$	Gate Leakage Current		$V_{GS} = \pm 20\text{V}$ , $V_{DS} = 0\text{V}$			$\pm 1.0$	$\mu\text{A}$
$I_{DSS}$	Zero Gate Voltage Drain Current		$V_{GS} = 0\text{V}$ , $V_{DS} = 500\text{V}$			1.0	mA
$V_{(BR)DS}$	Drain-Source Breakdown Voltage		$V_{GS} = 0\text{V}$ , $I_D = 1\text{mA}$	500			V
$V_{GS(th)}$	Gate-Source Threshold Voltage		$V_{DS} = V_{GS}$ , $I_D = 10\text{mA}$	1.0		5.0	V
$R_{DS(on)}$	Drain-Source On-State Resistance		$I_D = 40\text{A}$ , $V_{GS} = 15\text{V}$			110	m $\Omega$
$V_{DS(on)}$	Drain-Source On-State Voltage		$I_D = 40\text{A}$ , $V_{GS} = 15\text{V}$			4.4	V
$g_{fs}$	Forward Transconductance		$V_{DS} = 10\text{V}$ , $I_D = 40\text{A}$		40		S
$C_{iss}$	Input Capacitance		$V_{GS} = 0\text{V}$ , $V_{DS} = 25\text{V}$ , $f = 1.0\text{MHz}$			13500	pF
$C_{oss}$	Output Capacitance		$V_{GS} = 0\text{V}$ , $V_{DS} = 25\text{V}$ , $f = 1.0\text{MHz}$			2500	pF
$C_{rss}$	Reverse Transfer Capacitance		$V_{GS} = 0\text{V}$ , $V_{DS} = 25\text{V}$ , $f = 1.0\text{MHz}$			1000	pF
$t_{d(on)}$	Switching Time	Turn-on Delay Time	$V_{DD} = 300\text{V}$ , $V_{GS} = 15\text{V}$ $I_D = 40\text{A}$ , $R_G = 5\Omega$		70	ns	
$t_r$		Rise Time			140		
$t_{d(off)}$		Turn-off Delay Time			700		
$t_f$		Fall Time			210		
$V_{SDS}$	Diode Forward Voltage		$-I_S = 40\text{A}$ , $V_{GS} = 0\text{V}$			2.5	V
$t_{rr}$	Reverse Recovery Time		$-I_S = 40\text{A}$ , $V_{GS} = -5\text{V}$ , $di/dt = 100\text{A}/\mu\text{s}$		80	100	ns
$R_{th(j-c)}$	Thermal Resistance		MOSFET			0.29	$^\circ\text{C}/\text{W}$
			Diode			1.67	

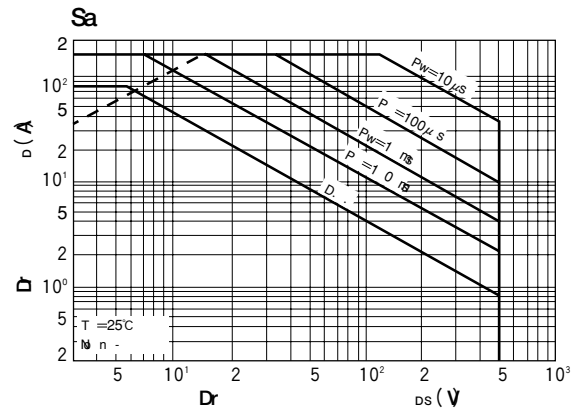
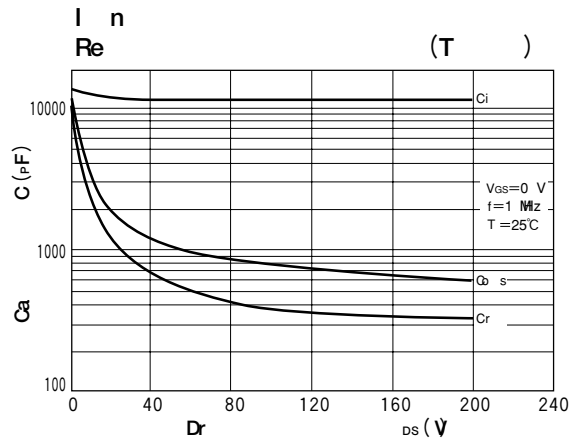
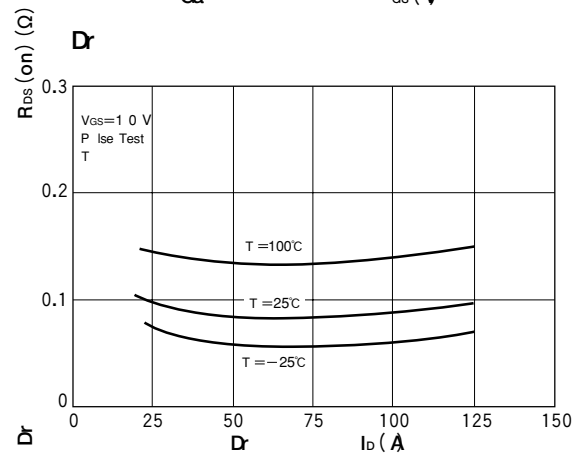
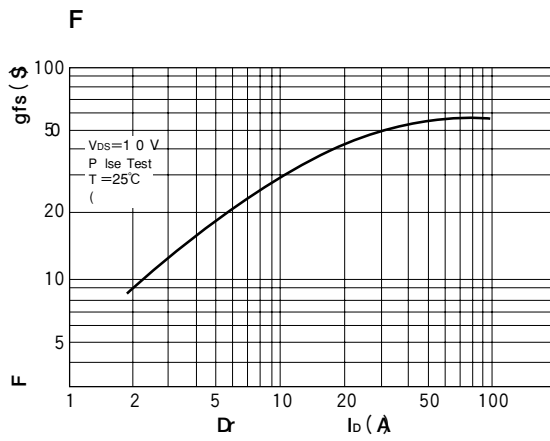
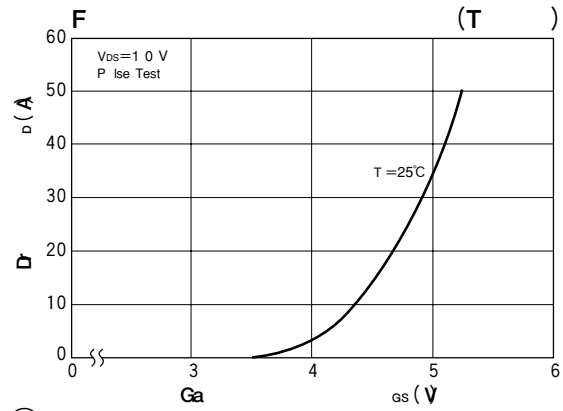
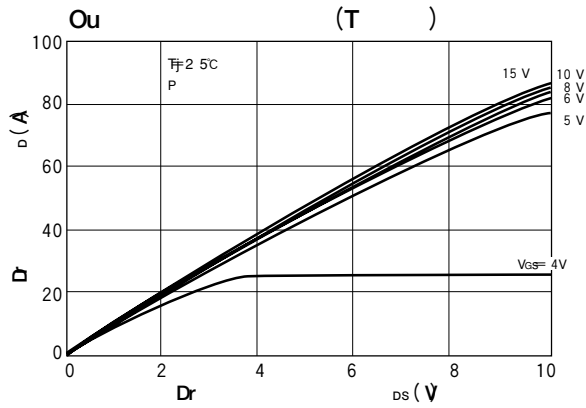

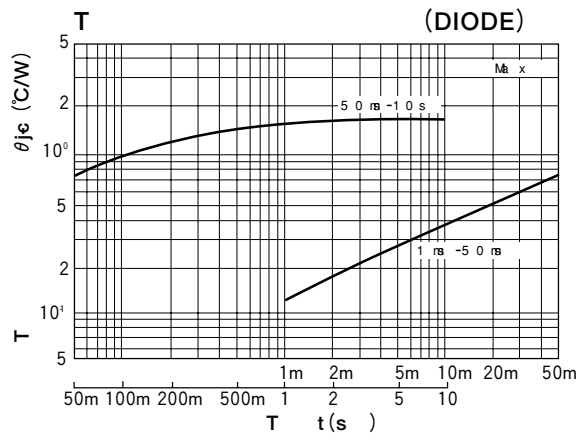
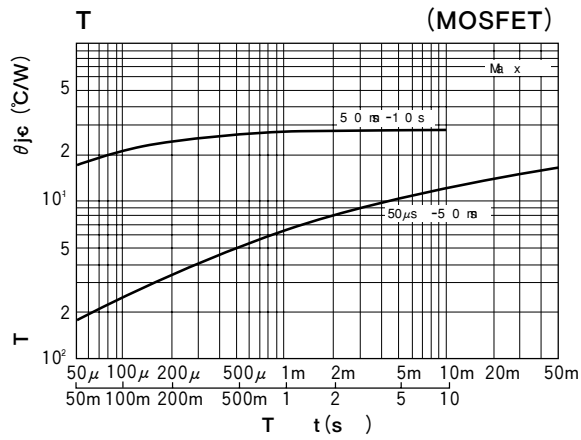
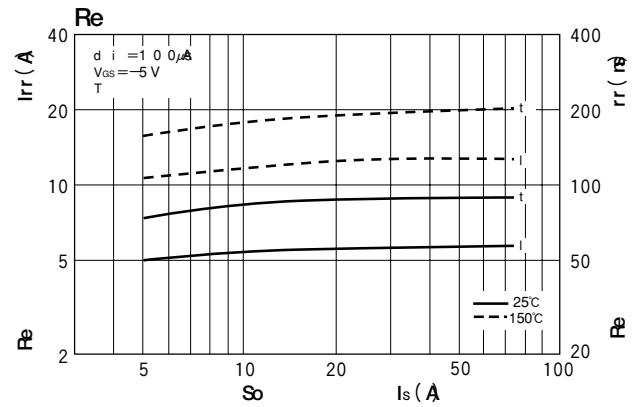
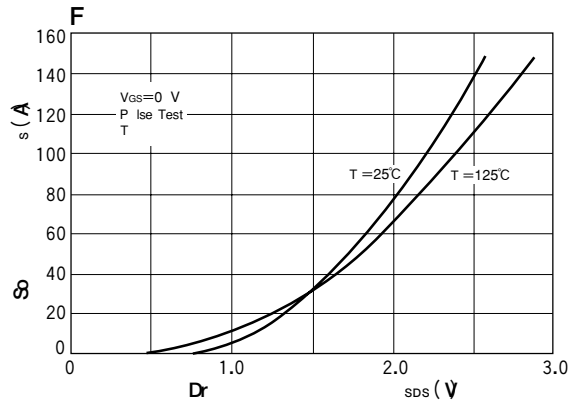

# MOSFET MODULE

# FBA50CA45/50



UL;E76102(M)

**FBA50CA45/50** is a dual power MOSFET module designed for fast switching applications of high voltage and current. (2 devices are serial connected.) The mounting base of the module is electrically isolated from semiconductor elements for simple heatsink construction.

- $I_D=50A$ ,  $V_{DS}=500V$
- Suitable for high speed switching applications.
- Low ON resistance.
- Wide Safe Operating Areas.

**(Applications)**

UPS(CVCF), Motor Control, Switching Power Supply, etc.

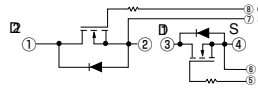
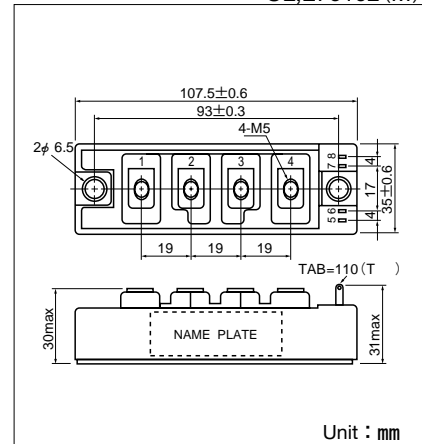

**Maximum Ratings**

( $T_j=25^\circ\text{C}$  u n l )

Symbol	Item		Conditions	Ratings		Unit
				FBA50CA45	FBA50CA50	
$V_{DS}$	Drain-Source Voltage			450	500	V
$V_{GS}$	Gate-Source Voltage			$\pm 20$		V
$I_D$	Drain Current	D.C.		50		A
$I_{DP}$		Pulse		100		
$-I_D$	Source Current			50		A
$P_T$	Total Power Dissipation		$T_c=25^\circ\text{C}$	320		W
$T_j$	Channel Temperature			150		$^\circ\text{C}$
$T_{stg}$	Storage Temperature			$-40$ t $+125$		$^\circ\text{C}$
$V_{iso}$	Isolation Voltage (R.M.S.)		A.C. 1minute	2500		V
	Mounting Torque	Mounting (M6)	Recommended Value 2.5-3.9 (25-40)	4.7 (48)		N·m (kgf·cm)
		Terminal (M5)	Recommended Value 1.5-2.5 (15-25)	2.7 (28)		
	Mass		Typical Value	220		g

**Electrical Characteristics**

( $T_j=25^\circ\text{C}$  u n l )

Symbol	Item		Conditions	Ratings			Unit
				Min.	Typ.	Max.	
$I_{GSS}$	Gate Leakage Current		$V_{GS}=\pm 20V$ , $V_{DS}=0V$			$\pm 1.0$	$\mu A$
$I_{DSS}$	Zero Gate Voltage Drain Current		$V_{GS}=0V$ , $V_{DS}=500V$			1.0	mA
$V_{(BR)DS}$	Drain-Source Breakdown Voltage	<b>FBA50CA45</b>	$V_{GS}=0V$ , $I_D=1mA$	450			V
		<b>FBA50CA50</b>		500			
$V_{GS(th)}$	Gate-Source Threshold Voltage		$V_{DS}=V_{GS}$ , $I_D=10mA$	1.0		5.0	V
$R_{DS(on)}$	Drain-Source On-State Resistance		$I_D=25A$ , $V_{GS}=15V$			120	m $\Omega$
$V_{DS(on)}$	Drain-Source On-State Voltage		$I_D=25A$ , $V_{GS}=15V$			3.0	V
$g_{fs}$	Forward Transconductance		$V_{DS}=10V$ , $I_D=25A$		30		S
$C_{iss}$	Input Capacitance		$V_{GS}=0V$ , $V_{DS}=25V$ , $f=1.0MHz$			10000	pF
$C_{oss}$	Output Capacitance		$V_{GS}=0V$ , $V_{DS}=25V$ , $f=1.0MHz$			1900	pF
$C_{rss}$	Reverse Transfer Capacitance		$V_{GS}=0V$ , $V_{DS}=25V$ , $f=1.0MHz$			750	pF
$t_{d(on)}$	Switching Time	Turn-on Delay Time	$R_L=12\Omega$ , $R_G=50\Omega$ , $V_{GS}=15V$ $I_D=25A$ , $R_G=5\Omega$		60		ns
$t_r$		Rise Time			60		
$t_{d(off)}$		Turn-off Delay Time			650		
$t_f$		Fall Time			130		
$V_{SDS}$	Diode Forward Voltage		$-I_D=25A$ , $V_{GS}=0V$			1.5	V
$t_{rr}$	Reverse Recovery Time		$-I_D=25A$ , $V_{GS}=0V$ , $di/dt=100A/\mu s$		700		ns
$R_{th(j-c)}$	Thermal Resistance					0.39	$^\circ\text{C}/W$

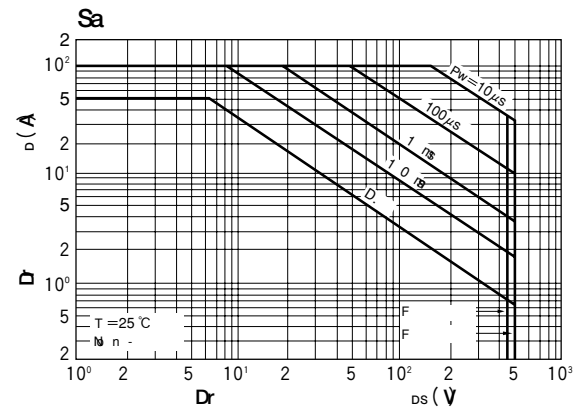
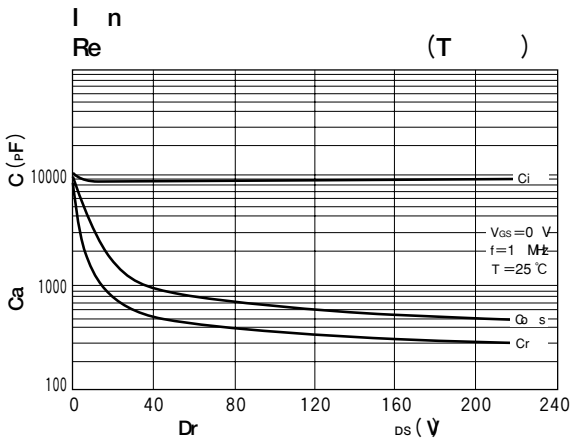
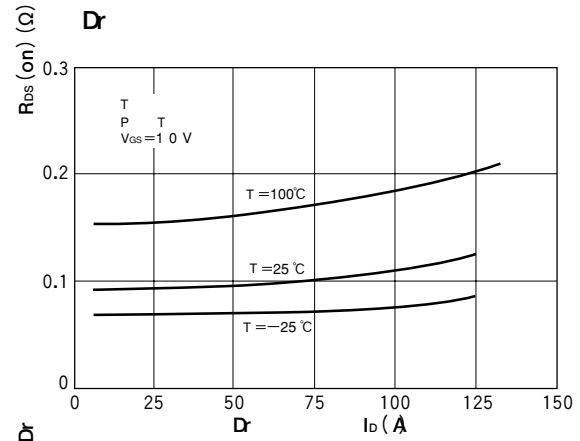
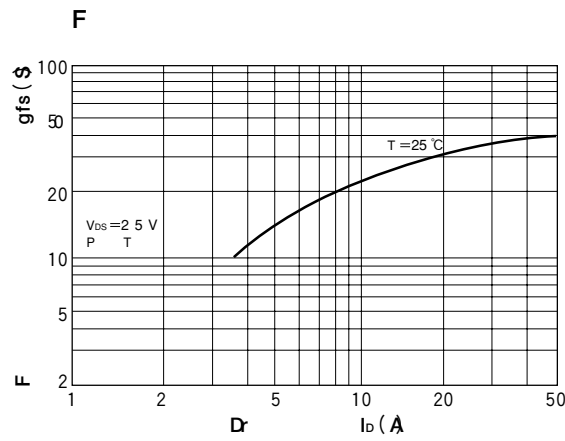
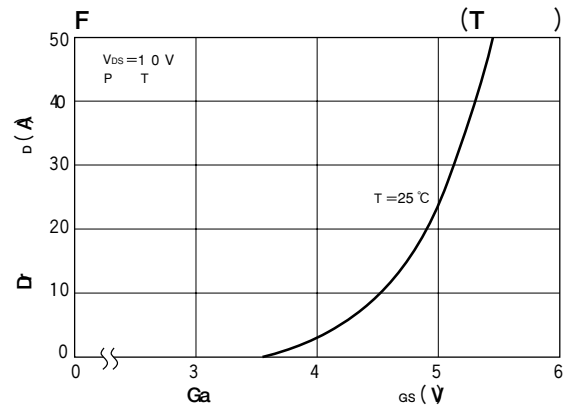
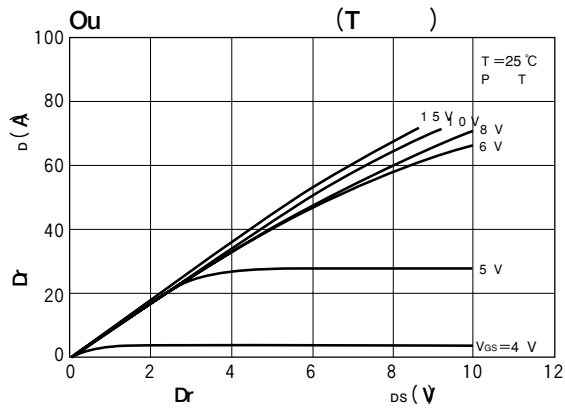



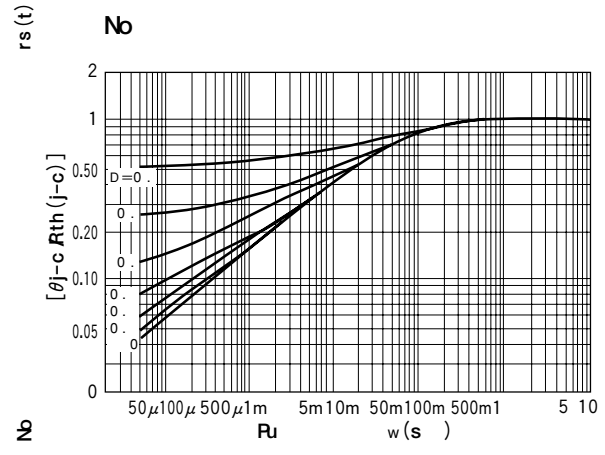
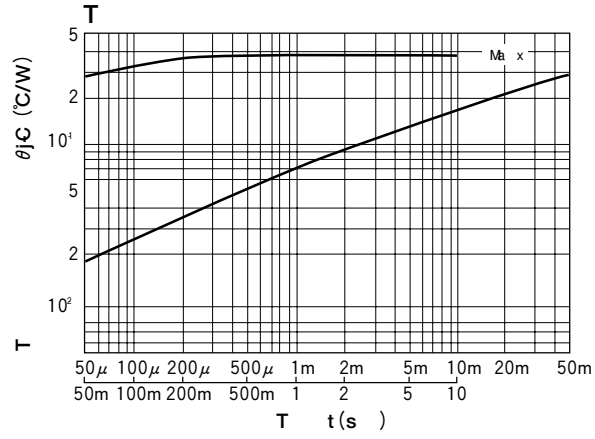
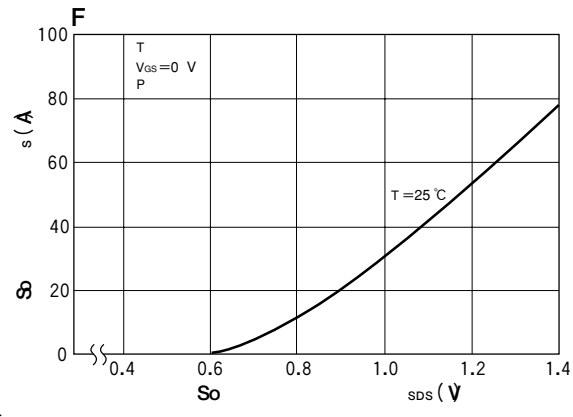

# MOSFET MODULE

# FBA75CA45/50



UL;E76102(M)

**FBA75CA45/50** is a dual power MOSFET module designed for fast switching applications of high voltage and current. (2 devices are serial connected.) The mounting base of the module is electrically isolated from semiconductor elements for simple heatsink construction.

- $I_D=75A$ ,  $V_{DS}=500V$
- Suitable for high speed switching applications.
- Low ON resistance.
- Wide Safe Operating Areas.

**(Applications)**

UPS(CVCF), Motor Control, Switching Power Supply, etc.

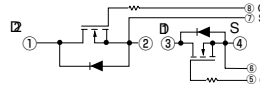
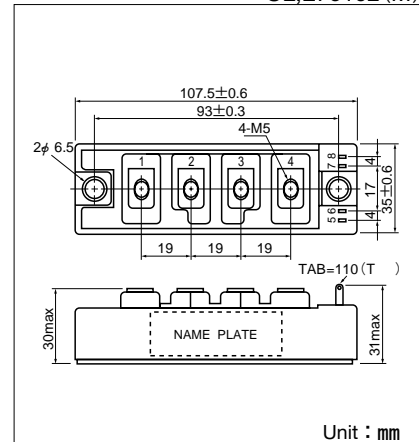

■ **Maximum Ratings**

( $T_j=25^\circ\text{C}$  u n l )

Symbol	Item		Conditions	Ratings		Unit
				FBA75CA45	FBA75CA50	
$V_{DS}$	Drain-Source Voltage			450	500	V
$V_{GS}$	Gate-Source Voltage			$\pm 20$		V
$I_D$	Drain Current	D.C.	Duty=36%	75		A
$I_{DP}$		Pulse		150		
$-I_D$	Source Current			75		A
$P_T$	Total Power Dissipation		$T_c=25^\circ\text{C}$	400		W
$T_j$	Channel Temperature			150		$^\circ\text{C}$
$T_{stg}$	Storage Temperature			$-40$ t $+125$		$^\circ\text{C}$
$V_{iso}$	Isolation Voltage (R.M.S.)		A.C. 1minute	2500		V
	Mounting Torque	Mounting (M6)	Recommended Value 2.5-3.9 (25-40)	4.7 (48)		N·m (kgf·cm)
		Terminal (M5)	Recommended Value 1.5-2.5 (15-25)	2.7 (28)		
	Mass		Typical Value	220		g

■ **Electrical Characteristics**

( $T_j=25^\circ\text{C}$  u n l )

Symbol	Item		Conditions	Ratings			Unit
				Min.	Typ.	Max.	
$I_{GSS}$	Gate Leakage Current		$V_{GS}=\pm 20V$ , $V_{DS}=0V$			$\pm 1.0$	$\mu A$
$I_{DSS}$	Zero Gate Voltage Drain Current		$V_{GS}=0V$ , $V_{DS}=500V$			1.0	mA
$V_{(BR)DS}$	Drain-Source Breakdown Voltage	<b>FBA75CA45</b>	$V_{GS}=0V$ , $I_D=1mA$	450			V
		<b>FBA75CA50</b>		500			
$V_{GS(th)}$	Gate-Source Threshold Voltage		$V_{DS}=V_{GS}$ , $I_D=10mA$	1.0		5.0	V
$R_{DS(on)}$	Drain-Source On-State Resistance		$I_D=40A$ , $V_{GS}=15V$			0.10	$\Omega$
$V_{DS(on)}$	Drain-Source On-State Voltage		$I_D=40A$ , $V_{GS}=15V$			4.0	V
$g_{fs}$	Forward Transconductance		$V_{DS}=10V$ , $V_D=40A$		40		S
$C_{iss}$	Input Capacitance		$V_{GS}=0V$ , $V_{DS}=25V$ , $f=1.0MHz$			13500	pF
$C_{oss}$	Output Capacitance		$V_{GS}=0V$ , $V_{DS}=25V$ , $f=1.0MHz$			2500	pF
$C_{rss}$	Reverse Transfer Capacitance		$V_{GS}=0V$ , $V_{DS}=25V$ , $f=1.0MHz$			1000	pF
$t_{d(on)}$	Switching Time	Turn-on Delay Time	$R_L=7.5\Omega$ , $R_G=50\Omega$ , $V_{GS}=15V$ $I_D=40A$ , $R_G=5\Omega$		60		ns
$t_r$		Rise Time			120		
$t_{d(off)}$		Turn-off Delay Time			700		
$t_f$		Fall Time			210		
$V_{SDS}$	Diode Forward Voltage		$-I_D=40A$ , $V_{GS}=0V$			1.5	V
$t_{rr}$	Reverse Recovery Time		$-I_D=40A$ , $V_{GS}=0V$ , $di/dt=100A/\mu s$		700		ns
$R_{th(j-c)}$	Thermal Resistance					0.31	$^\circ\text{C}/W$

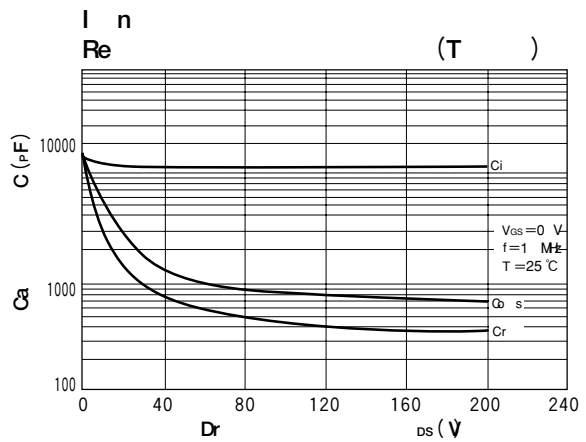
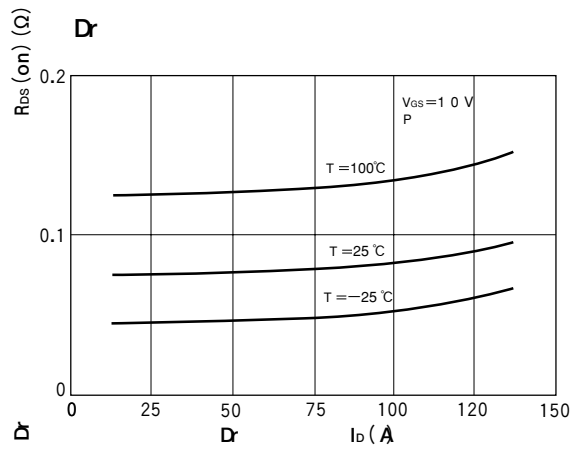
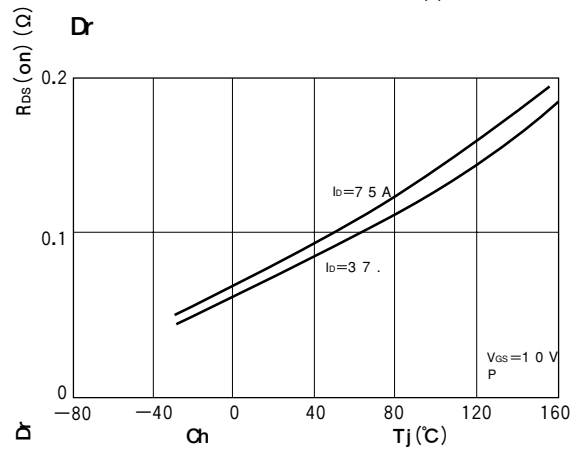
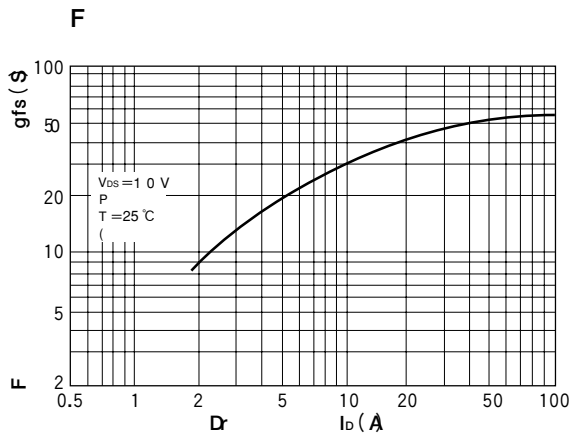
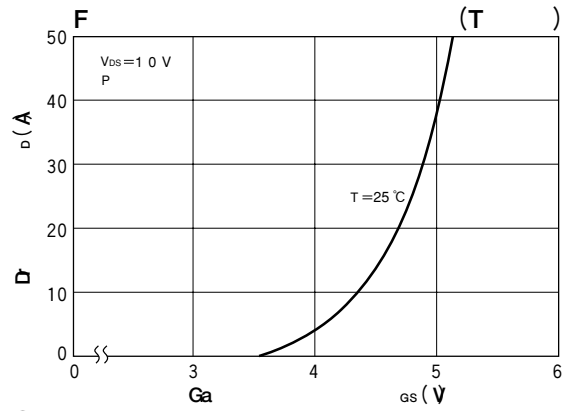
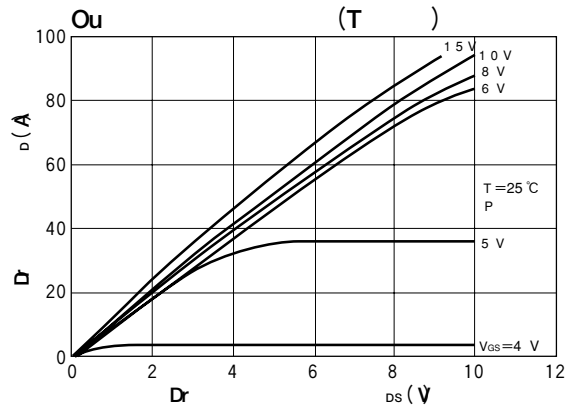

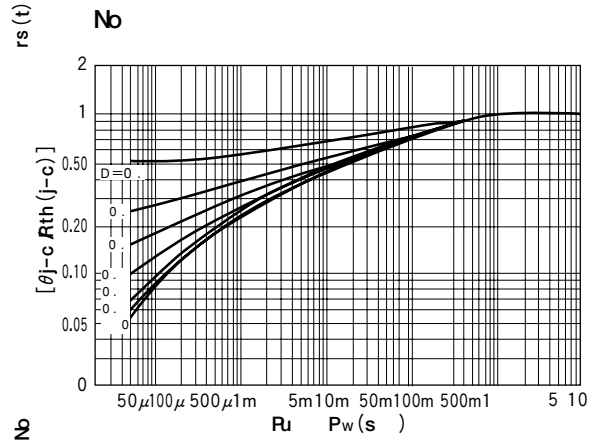
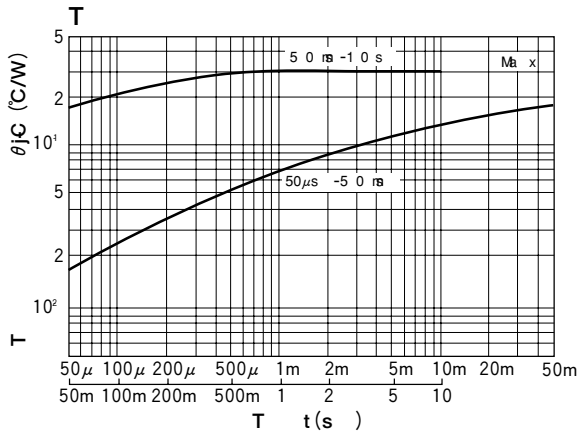
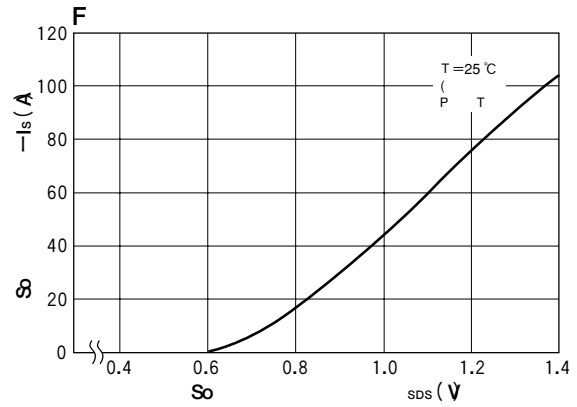
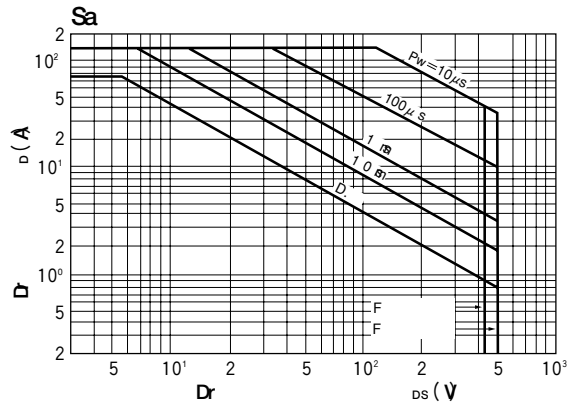

# MOSFET MODULE

# SF100BA50



UL;E76102(M)

**SF100BA50** is a isolated power MOSFET module designed for fast switching applications of high voltage and current. The mounting base of the module is electrically isolated from semiconductor elements for simple heatsink construction.

- $I_D=100A$ ,  $V_{DS}=500V$
- Suitable for high speed switching applications.
- Low ON resistance.
- Wide Safe Operating Areas.
- $t_{rr} \leq 700ns$

**(Applications)**

UPS (CVCF), Motor Control, Switching Power Supply, etc.

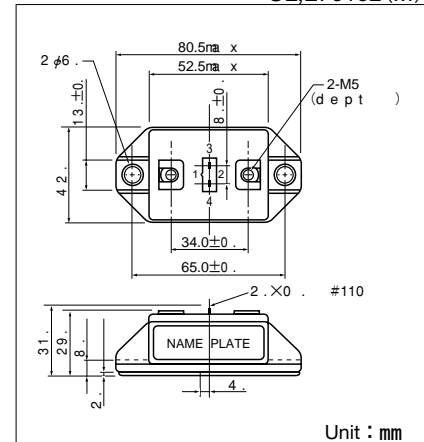
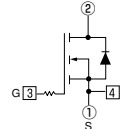

**Maximum Ratings**

( $T_j=25^\circ C$  u n l )

Symbol	Item		Conditions	Ratings		Unit
				SF100BA50		
$V_{DS}$	Drain-Source Voltage			500		V
$V_{GS}$	Gate-Source Voltage			$\pm 20$		V
$I_D$	Drain Current	DC	Duty=43%	100		A
$I_{DP}$		Pulse		200		
$-I_D$	Source Current			100		A
$P_T$	Total Power Dissipation		$T_c=25^\circ C$	600		W
$T_j$	Channel Temperature			$-40 \sim +150$		$^\circ C$
$T_{stg}$	Storage Temperature			$-40 \sim +125$		$^\circ C$
$V_{iso}$	Isolation Voltage (R.M.S.)		A.C. 1minute	2500		V
	Mounting Torque	Mounting (M6)	Recommended Value 2.5~3.9 (25~40)	4.7 (48)		N·m (kgf·cm)
		Terminal (M5)	Recommended Value 1.5~2.5 (15~25)	2.7 (28)		
	Mass		Typical Value	160		g

**Electrical Characteristics**

( $T_j=25^\circ C$  u n l )

Symbol	Item		Conditions	Ratings			Unit
				Min.	Typ.	Max.	
$I_{GSS}$	Gate Leakage Current		$V_{GS}=\pm 20V$ , $V_{DS}=0V$			$\pm 2.0$	$\mu A$
$I_{DSS}$	Zero Gate Voltage Drain Current		$V_{GS}=0V$ , $V_{DS}=500V$			1.0	mA
$V_{(BR)DS}$	Drain-Source Breakdown Voltage		$V_{GS}=0V$ , $I_D=1mA$	500			V
$V_{GS(th)}$	Gate-Source Threshold Voltage		$V_{DS}=V_{GS}$ , $I_D=10mA$	1.0		5.0	V
$R_{DS(on)}$	Drain-Source On-State Resistance		$I_D=50A$ , $V_{GS}=15V$			70	m $\Omega$
$V_{DS(on)}$	Drain-Source On-State Voltage		$I_D=50A$ , $V_{GS}=15V$			3.5	V
$g_{fs}$	Forward Transconductance		$V_{DS}=10A$ , $I_D=50A$		60		S
$C_{iss}$	Input Capacitance		$V_{GS}=0V$ , $V_{DS}=25V$ , $f=1.0MHz$			20000	pF
$C_{oss}$	Output Capacitance		$V_{GS}=0V$ , $V_{DS}=25V$ , $f=1.0MHz$			3800	pF
$C_{rss}$	Reverse Transfer Capacitance		$V_{GS}=0V$ , $V_{DS}=25V$ , $f=1.0MHz$			1500	pF
$t_{d(on)}$	Switching Time	Turn-on Delay Time	$R_L=6\Omega$ , $R_G=50\Omega$ , $V_{GS}=15V$ $I_D=50A$ , $R_G=5\Omega$		70	$\mu s$	
$t_r$		Rise Time			120		
$t_{d(off)}$		Turn-off Delay Time			1100		
$t_f$		Fall Time			280		
$V_{SDS}$	Diode Forward Voltage		$-I_D=50A$ , $V_{GS}=0V$			1.5	V
$t_{rr}$	Reverse Recovery Time		$-I_D=50A$ , $V_{GS}=0V$ , $di/dt=100A/\mu s$		700		ns
$R_{th(j-c)}$	Thermal Resistance					0.21	$^\circ C/W$

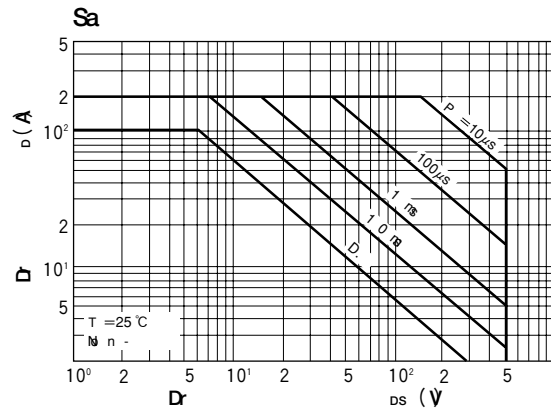
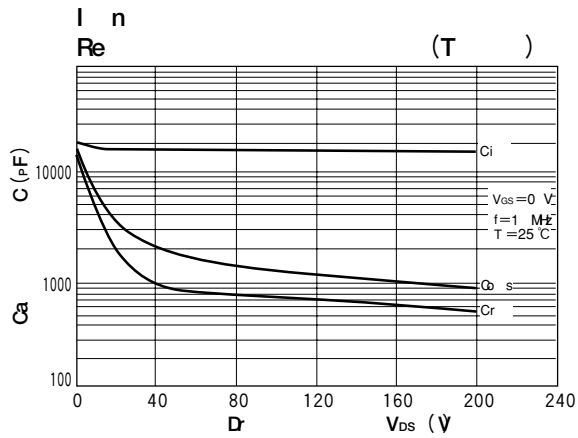
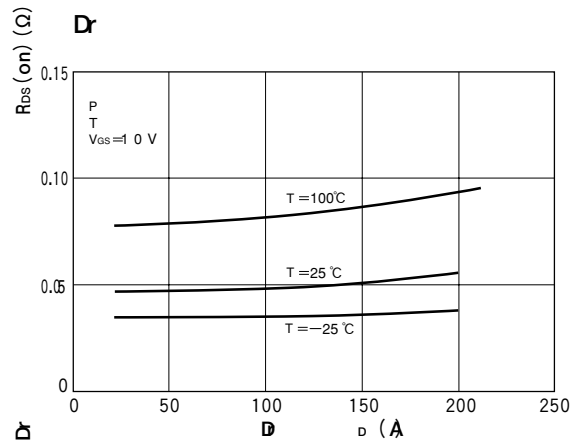
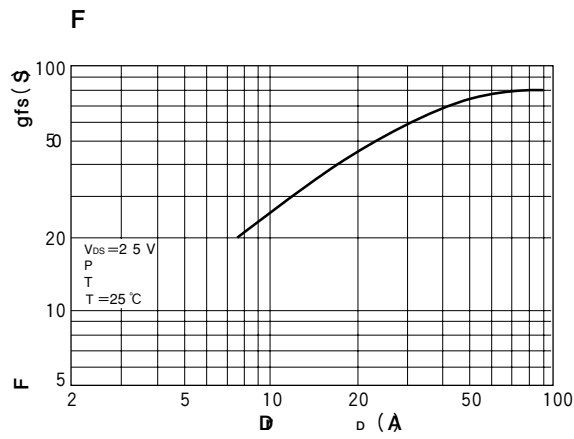
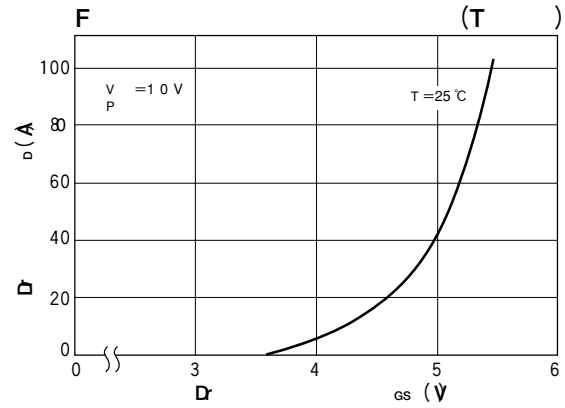
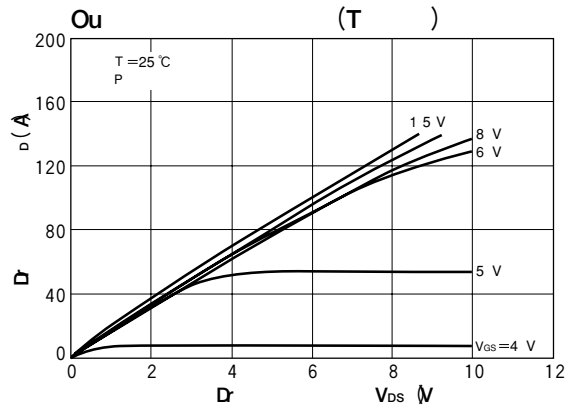

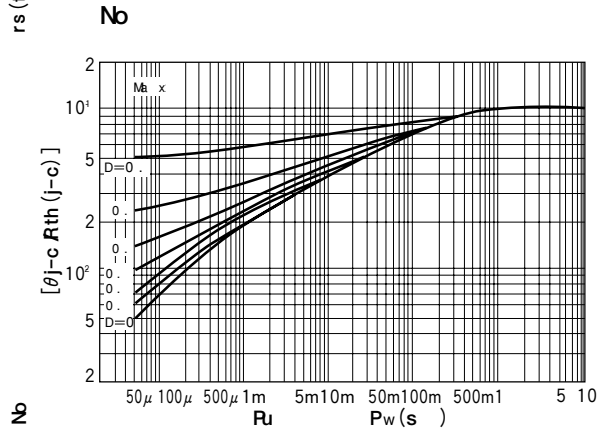
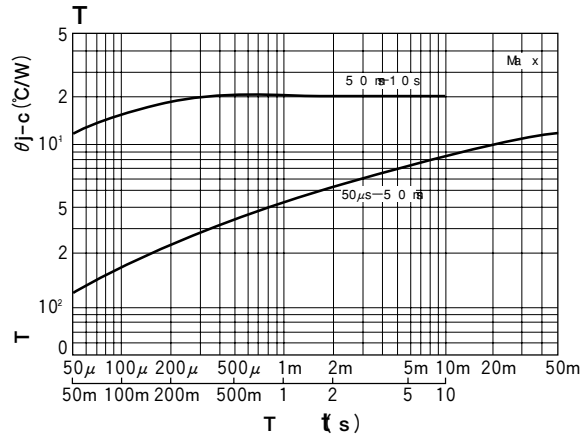
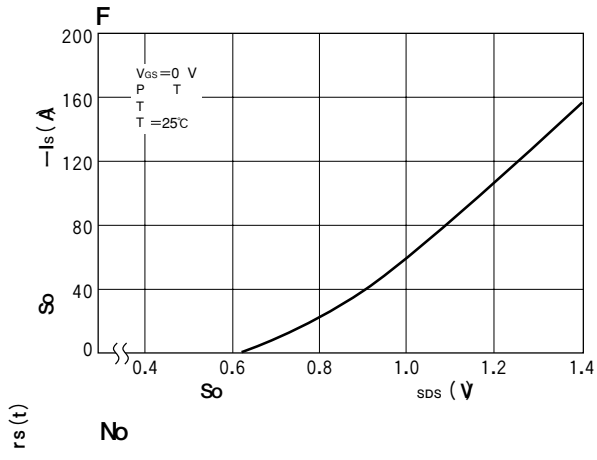

# MOSFET MODULE

# SF150BA50



UL;E76102(M)

**SF150BA50** is a isolated power MOSFET module designed for fast switching applications of high voltage and current. The mounting base of the module is electrically isolated from semiconductor elements for simple heatsink construction.

- $I_D=150A$ ,  $V_{DS}=500V$
- Suitable for high speed switching application.
- Low ON resistance.
- Wide Safe Operating Areas.

(Applications)

UPS(CVCF), Motor Control, Switching Power Supply, etc.

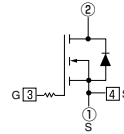
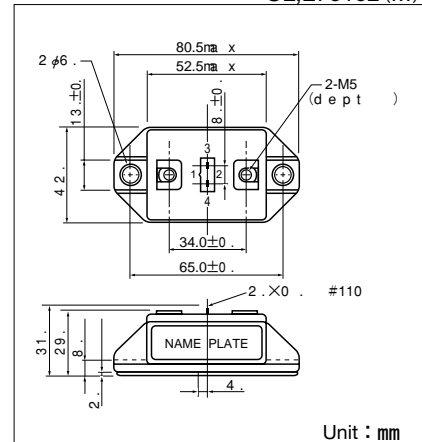

## Maximum Ratings

( $T_j=25^\circ\text{C}$  u n l )

Symbol	Item		Conditions	Ratings			Unit
				SF150BA50			
$V_{DS}$	Drain-Source Voltage			500			V
$V_{GS}$	Gate-Source Voltage			$\pm 20$			V
$I_D$	Drain Current	DC	Duty=35%	150			A
$I_{DP}$		Pulse		300			
$-I_D$	Source Current			150			A
$P_T$	Total Power Dissipation		$T_c=25^\circ\text{C}$	780			W
$T_j$	Channel Temperature			$-40$ t $+150$			$^\circ\text{C}$
$T_{stg}$	Storage Temperature			$-40$ t $+125$			$^\circ\text{C}$
$V_{iso}$	Isolation Voltage (R.M.S.)		A.C. 1minute	2500			V
	Mounting Torque	Mounting (M6)	Recommended Value 2.5-3.9 (25-40)	4.7 (48)			N·m (kgf·cm)
		Terminal (M5)	Recommended Value 1.5-2.5 (15-25)	2.7 (28)			
	Mass		Typical Value	160			g

## Electrical Characteristics

( $T_j=25^\circ\text{C}$  u n l )

Symbol	Item		Conditions	Ratings			Unit
				Min.	Typ.	Max.	
$I_{GSS}$	Gate Leakage Current		$V_{GS}=\pm 20V$ , $V_{DS}=0V$			$\pm 2.0$	$\mu A$
$I_{DSS}$	Zero Gate Voltage Drain Current		$V_{GS}=0V$ , $V_{DS}=500V$			2.0	mA
$V_{(BR)DS}$	Drain-Source Breakdown Voltage		$V_{GS}=0V$ , $I_D=1mA$	500			V
$V_{GS(th)}$	Gate-Source Threshold Voltage		$V_{DS}=V_{GS}$ , $I_D=10mA$	1.0		5.0	V
$R_{DS(on)}$	Drain-Source On-State Resistance		$I_D=75A$ , $V_{GS}=15V$			50	m $\Omega$
$V_{DS(on)}$	Drain-Source On-State Voltage		$I_D=75A$ , $V_{GS}=15V$			3.75	V
$g_{fs}$	Forward Transconductance		$V_{DS}=10V$ , $I_D=75A$		80		S
$C_{iss}$	Input Capacitance		$V_{GS}=0V$ , $V_{DS}=25V$ , $f=1.0MHz$			27000	pF
$C_{oss}$	Output Capacitance		$V_{GS}=0V$ , $V_{DS}=25V$ , $f=1.0MHz$			5000	pF
$C_{rss}$	Reverse Transfer Capacitance		$V_{GS}=0V$ , $V_{DS}=25V$ , $f=1.0MHz$			2000	pF
$t_{d(on)}$	Switching Time	Turn-on Delay Time	$R_L=4\Omega$ , $R_G=50\Omega$ , $V_{GS}=15V$ $I_D=75A$ , $R_G=5\Omega$		90		ns
$t_r$		Rise Time			180		
$t_{d(off)}$		Turn-off Delay Time			1400		
$t_f$		Fall Time			360		
$V_{SDS}$	Diode Forward Voltage		$-I_D=75A$ , $V_{GS}=0V$			1.5	V
$t_{rr}$	Reverse Recovery Time		$-I_D=75A$ , $V_{GS}=0V$ , $di/dt=100A/\mu s$		700		ns
$R_{th(j-c)}$	Thermal Resistance					0.16	$^\circ\text{C}/W$



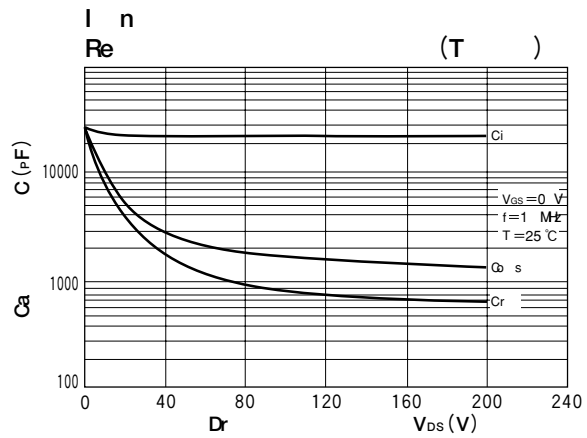
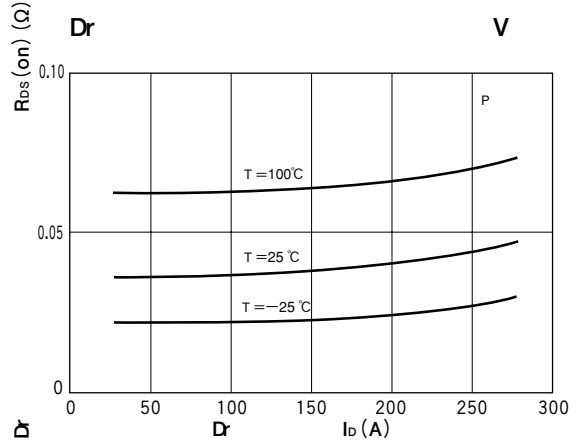
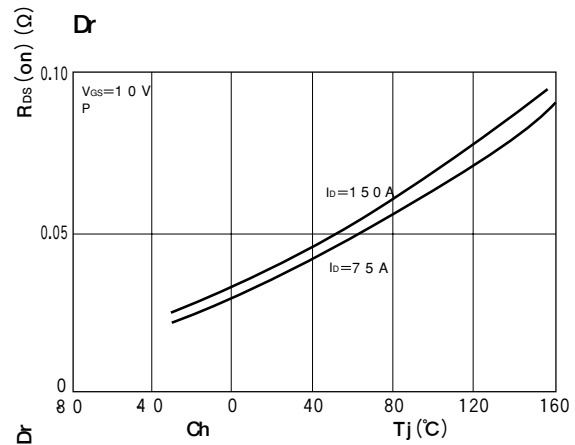
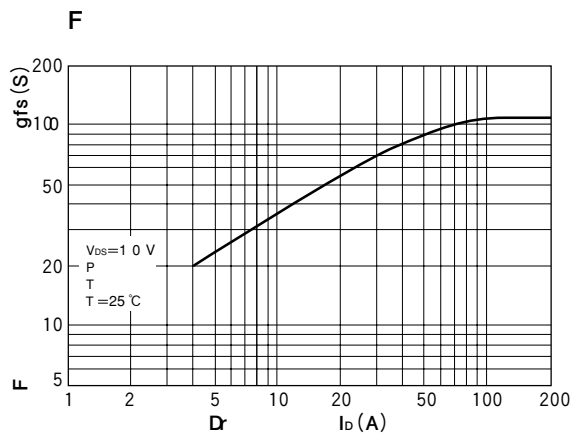
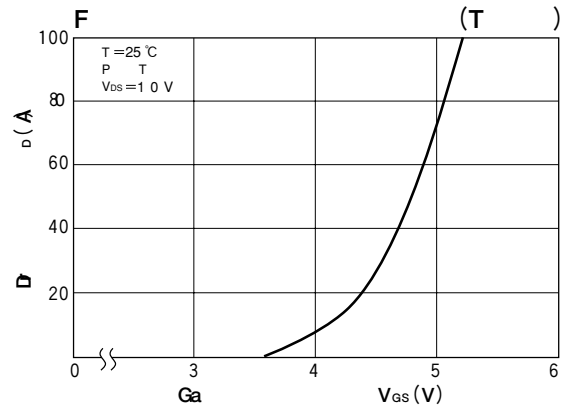
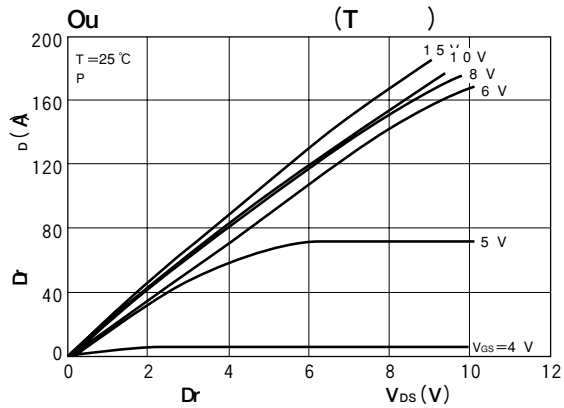

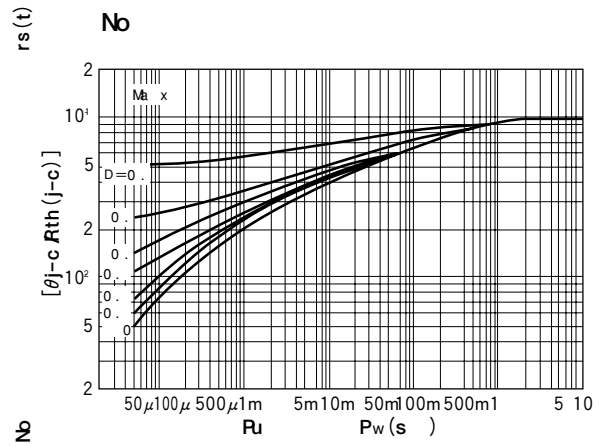
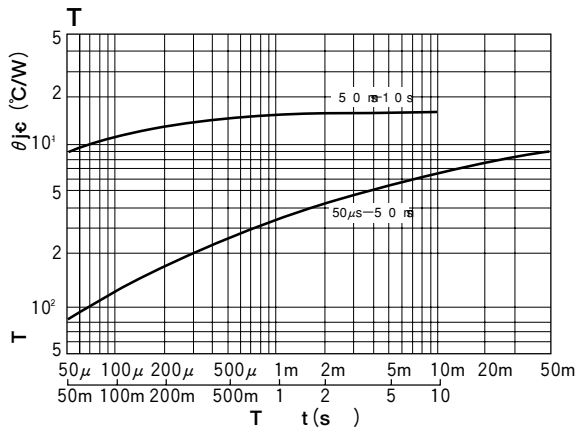
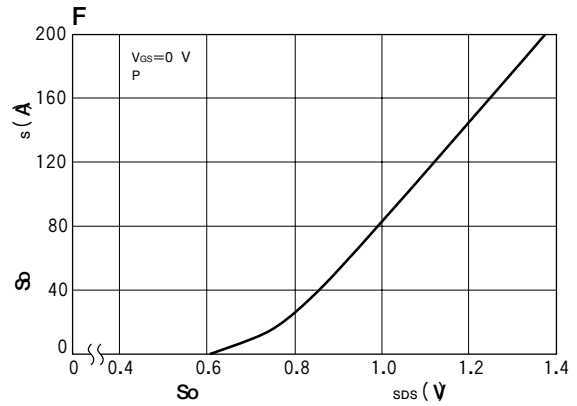
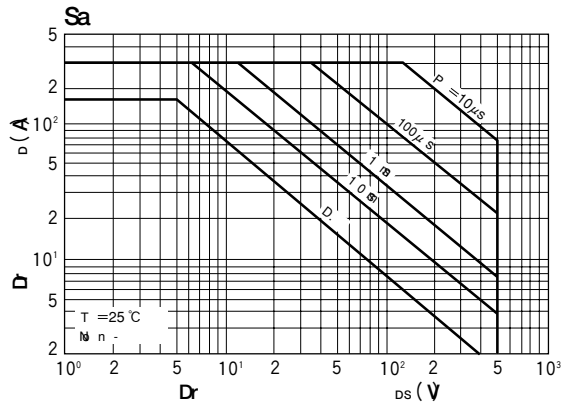

# MOSFET MODULE

# SF100CB100



UL;E76102(M)

**SF100CB100** is a isolated power MOSFET module designed for fast swiching applications of high voltage and current with a fast recovery diode ( $t_{rr} \leq 300\text{ns}$ ) reverse connected. The mounting base of the module is electrically isolated from semiconductor elements for simple heatsink construction.

- $I_D=100\text{A}$ ,  $V_{DSS}=1000\text{V}$
- Suitable for high speed switching applications.
- Low ON resistance.
- Wide Safe Operating Areas.
- $t_{rr} \leq 300\text{ns}$  fast recovery diode for free wheel

(Applications)

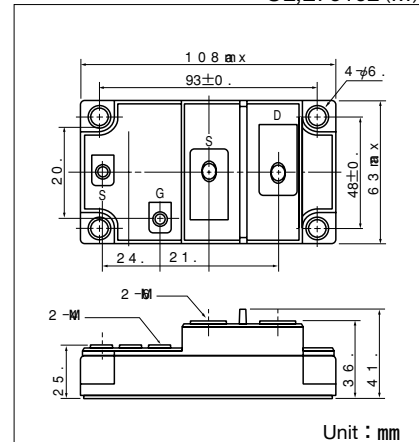
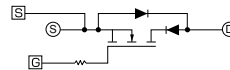

## Maximum Ratings

( $T_j=25^\circ\text{C}$  u n l )

Symbol	Item		Conditions	Ratings			Unit
				SF100CB100			
$V_{DSS}$	Drain-Source Voltage			1000			V
$V_{GSS}$	Gate-Source Voltage			$\pm 30$			V
$I_D$	Drain Current	DC		100			A
$I_{DP}$		Pulse		200			
$-I_D$	Source Current			100			A
$P_T$	Total Power Dissipation		$T_c=25^\circ\text{C}$	800			W
$T_j$	Channel Temperature			$-40$ t $+150$			$^\circ\text{C}$
$T_{stg}$	Storage Temperature			$-40$ t $+125$			$^\circ\text{C}$
$V_{iso}$	Isolation Voltage (R.M.S.)		A.C. 1minute	2500			V
Mounting Torque	Mounting (M6)	Terminal (M6)	Recommended Value 2.5-3.9 (25-40)	4.7 (48)			N·m (kgf·cm)
		Terminal (M6)	Recommended Value 2.5-3.9 (25-40)	4.7 (48)			
		Terminal (M4)	Recommended Value 1.0-1.4 (10-14)	1.5 (15)			
	Mass		Typical Value	460			g

## Electrical Characteristics

( $T_j=25^\circ\text{C}$  u n l )

Symbol	Item		Conditions	Ratings			Unit
				Min.	Typ.	Max.	
$I_{GSS}$	Gate Leakage Current		$V_{GS}=\pm 20\text{V}$ , $V_{DS}=0\text{V}$			$\pm 0.1$	$\mu\text{A}$
$I_{DSS}$	Zero Gate Voltage Drain Current		$V_{GS}=0\text{V}$ , $V_{DS}=800\text{V}$			4.0	mA
$V_{(BR)DSS}$	Darin-Source Breakdown Voltage		$V_{GS}=0\text{V}$ , $I_D=1\text{mA}$	1000			V
$V_{GS(th)}$	Gate-Source Threshold Voltage		$V_{DS}=V_{GS}$ , $I_D=10\text{mA}$	1.5			V
$R_{DS(on)}$	Drain-Source On-State Resistance		$I_D=100\text{A}$ , $V_{GS}=15\text{V}$	150			m $\Omega$
$V_{DS(on)}$	Drain-Source On-State Voltage		$I_D=100\text{A}$ , $V_{GS}=15\text{V}$	15			V
$g_{fs}$	Forward Transconductance		$V_{DS}=10\text{A}$ , $V_D=75\text{A}$	30	50		S
$C_{iss}$	Input Capacitance		$V_{GS}=0\text{V}$ , $V_{DS}=25\text{V}$ , $f=1.0\text{MHz}$	16000	19200		pF
$C_{oss}$	Output Capacitance		$V_{GS}=0\text{V}$ , $V_{DS}=25\text{V}$ , $f=1.0\text{MHz}$	2900	4200		pF
$C_{rss}$	Reverse Transfer Capacitance		$V_{GS}=0\text{V}$ , $V_{DS}=25\text{V}$ , $f=1.0\text{MHz}$	1800	2600		pF
$t_{d(on)}$	Switching Time	Turn-on Delay Time	$R_L=6\Omega$ , $V_{GS}=15\text{V}/-5\text{V}$ $I_D=100\text{A}$ , $R_G=2.2\Omega$			150	ns
$t_r$		Rise Time				300	
$t_{d(off)}$		Turn-off Delay Time				600	
$t_f$		Fall Time				300	
$V_{SDS}$	Diode Forward Voltage		$-I_D=100\text{A}$ , $V_{GS}=0\text{V}$			1.8	V
$t_{rr}$	Reverse Recovery Time		$-I_D=100\text{A}$ , $V_{GS}=15\text{V}$ , $di/dt=400\text{A}/\mu\text{s}$			300	ns
$R_{th(j-c)}$	Thermal Resistance		MOSFET			0.16	$^\circ\text{C}/\text{W}$
			Diode			0.64	

