



Data Sheet

MicroRAM™

Output Ripple Attenuation Module



Features

- RoHS Compliant (with F or G pin option)
- >40 dB ripple attenuation from 60 Hz to 1 MHz
- Integrated OR'ing diode supports N+1 redundancy
- Significantly improves load transient response
- Efficiency up to 98%
- User selectable performance optimization
- Combined active and passive filtering
- 3 – 30 Vdc input range
- 20 and 30 Ampere ratings



Actual size:
2.28 x 1.45 x 0.5 in
57,9 x 36,8 x 12,7 mm

Product Highlights

Vicor's MicroRAM output ripple attenuation module combines both active and passive filtering to achieve greater than 40 dB of noise attenuation from 60 Hz to 1 Mhz. The MicroRAM operates over a range of 3 to 30 Vdc, is available in either 20 or 30 A models and is compatible with most manufacturers switching converters including all Vicor DC-DC converter models.

The MicroRAM's closed loop architecture greatly improves load transient response and with dual mode control, insures precise point of load voltage regulation, The MicroRAM supports redundant and parallel operation with its integrated OR'ing diode function.

It is available in Vicor's standard Micro package (quarter brick) with a variety of terminations for through hole, socket or surface mount applications.

Absolute Maximum Ratings

Parameter	Rating	Unit	Notes
+In to -In	30	Vdc	Continuous
	40	Vdc	100ms
Load current	40	Adc	Continuous
Ripple Input (Vp-p)	100	mV	60 Hzc 100 kHz
	500	mV	100 kHz – 2 MHz
Mounting torque	4 – 6	In. lbs	6 each, 4-40 screw
	(0.45 – 0.68)	(Nm)	
Pin soldering temperature	500 (260)	°F (°C)	<5 sec; wave solder
	750 (390)	°F (°C)	<7 sec; wave solder

Thermal Resistance

Parameter	Typ	Unit
Baseplate to sink flat, greased surface	0.16	°C/Watt
	0.14	°C/Watt
Baseplate to ambient free convection	8.0	°C/Watt
	1.9	°C/Watt
1000 LFM		

Part Numbering

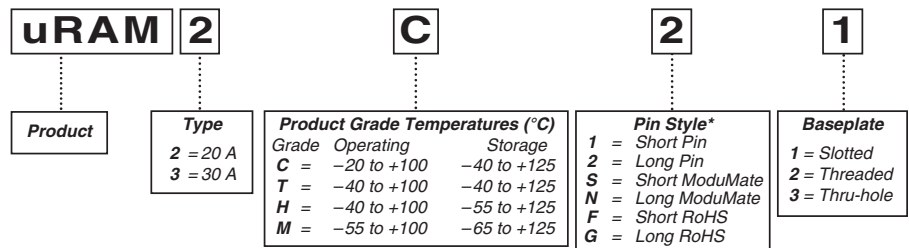

*Pin styles S & N are compatible with the ModuMate interconnect system for socketing and surface mounting.

ELECTRICAL CHARACTERISTICS

Electrical characteristics apply over the full operating range of input voltage, output power and baseplate temperature, unless otherwise specified. All temperatures refer to the operating temperature at the center of the baseplate.

■ μ RAM MODULE SPECIFICATIONS (-20°C to +100°C baseplate temperature)

Parameter	Min	Typ	Max	Unit	Notes
Operating current range					No internal current limiting. Converter input must be properly fused such that the μ RAM output current does not exceed the maximum operating current rating by more than 30% under a steady state condition.
μ RAM2xxx	0.02		20	A	
μ RAM3xxx	0.02		30	A	
Operating input voltage	3.0		30	Vdc	Continuous
Transient output response Load current step <1A/ μ sec			50	mVp-p	Step load change; see Figures 9, 12, & 15, pp. 6-7
Transient output response Load current step <1A/ μ sec (CTRAN = 820 μ F)			50	mVp-p	Optional capacitance CTRAN can be used to increase transient current capability; See Figures 1 & 2 on p. 3 and Figures 10, 13, & 16 on pp. 6-7
VHR headroom voltage range ¹ @ 1A load	325		425	mV	See Figures 5, 6 & 7 See Table 1 for headroom setting resistor values
Output ripple Input Vp-p = 100 mV			10	mVp-p	Ripple frequency 60 Hz to 100 kHz; optional capacitor CHR = 100 μ F required to increase low frequency attenuation as shown in Figures 3a and 3b see Figures 8, 11, & 14, pp. 6 – 7
			5	mVrms	
Output ripple Input Vp-p = 500 mV			10	mVp-p	Ripple frequency 100 kHz to 2 MHz; see Figures 8, 11, & 14, pp. 6-7
			5	mVrms	
SC output voltage ²	1.23			Vdc	See Table 1 RSC value
OR'ing threshold		10		mV	Vin – Vout
μ RAM bias current			60	mA	
Power dissipation					
μ RAM2xxx VHR = 380 mV@1 A		7.5		W	Vin = 28 V; Iout = 20 A
μ RAM3xxx VHR = 380 mV@1 A		11.5		W	Vin = 28 V; Iout = 30 A

¹ Headroom is the voltage difference between the +Input and +Output pins.

$$R_{HR} = (\mu\text{RAM +Out}/V_{HR}) \times 2.3 \text{ k (see Table 1 for example values)}$$

² SC resistor is required to trim the converter output up to accommodate the headroom of the μ RAM module when remote sense is not used. This feature can only be used when the trim reference of the converter is in the 1.21 to 1.25 Volt range. (see Table 1 with calculated Rsc resistor values)

$$R_{sc} = ((\mu\text{RAM +Out})/1.23 \text{ V} \times 1\text{k}) - 2 \text{ k}$$

μ RAM Out	VHR @ 1A	RHR Value (ohms)	Rsc Value (ohms)
3.0 V	375 mV	18.4 k	0.439 k
5.0 V	375 mV	30.6 k	2.07 k
12.0 V	375 mV	73.6 k	7.76 k
15.0 V	375 mV	92.0 k	10.20 k
24.0 V	375 mV	147.2 k	17.50 k
28.0 V	375 mV	171.7 k	20.76 k

Table 1 – RHR and RSC are computed values for a 375 mV case. To compute different headroom voltages, or for standard resistor values and tolerances, use Notes 1 and 2.

ELECTRICAL CHARACTERISTICS (CONT.)

APPLICATION SCHEMATIC DRAWINGS USING VICOR CONVERTERS AND THE μ RAM

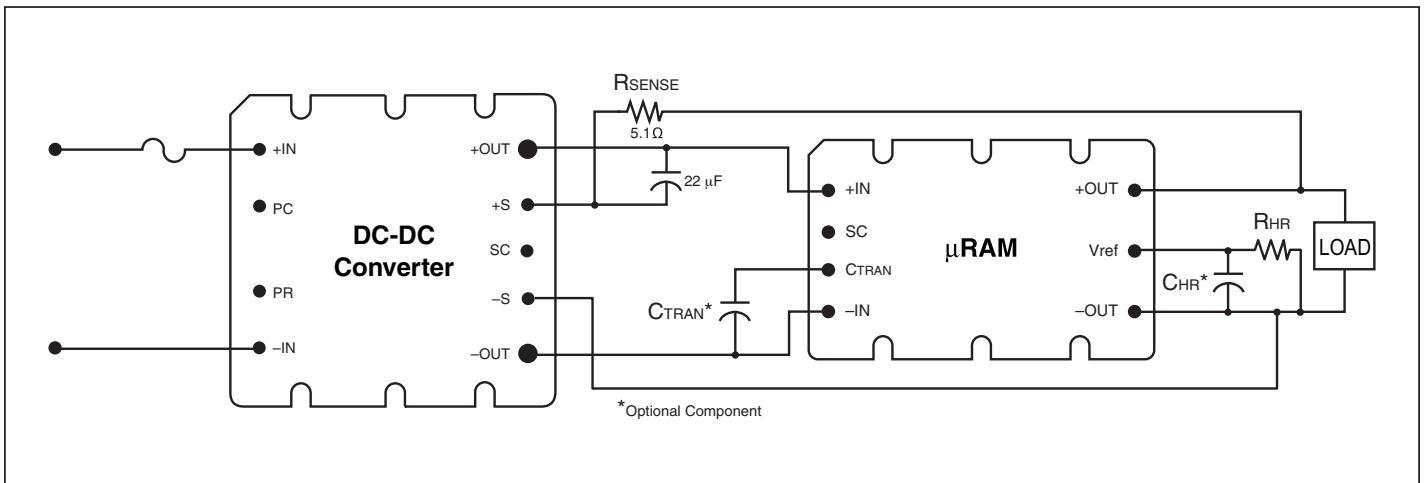

Figure 1 — Typical Configuration using Remote Sensing

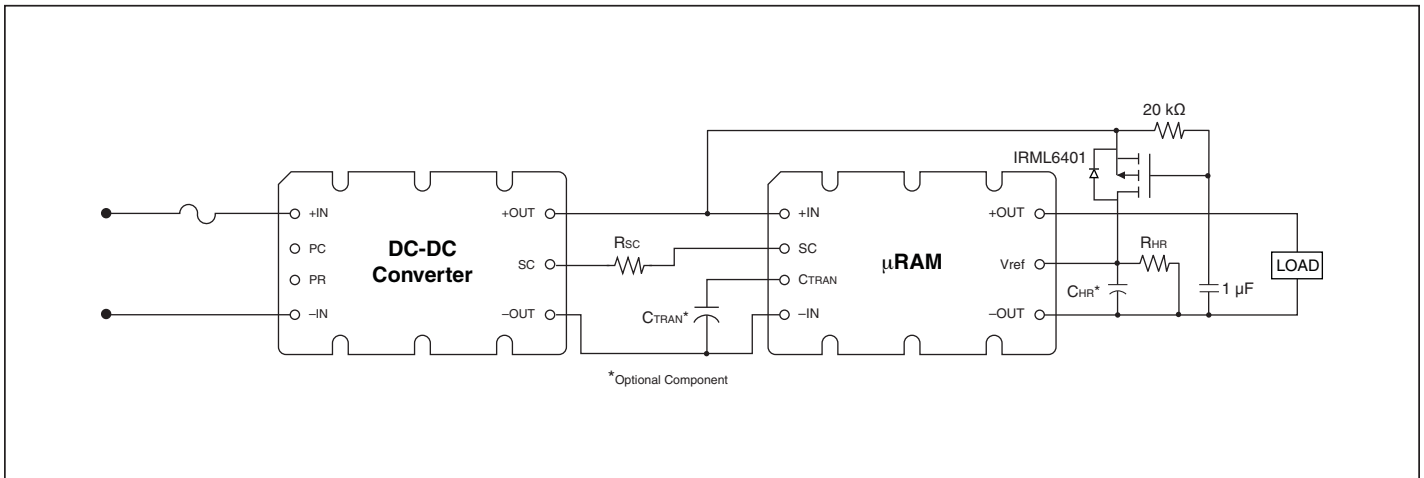

Figure 2 — Typical Configuration using SC Control (Optional CHR 25 μ F maximum in SC configuration.)

FUNCTIONAL DESCRIPTION

The MicroRAM has an internal passive filter that effectively attenuates ripple in the 50 kHz to 1 MHz range. An active filter provides attenuation from low frequency up to the 1 MHz range. The user must set the headroom voltage of the active block with the external RHR resistor to optimize performance. The MicroRAM must be connected as shown in Figures 1 or 2 depending on the load sensing method. The transient load current performance can be increased by the addition of optional CTRAN capacitance to the CTRAN pin. The low frequency ripple attenuation can be increased by addition of optional CHR capacitance to the VREF pin as shown in Figures 3a and 3b, on p. 5.

Transient load current is supplied by the internal CTRAN capacitance, plus optional external capacitance, during the time it takes the converter loop to respond to the increase in load. The MicroRAM's active loop responds in roughly one microsecond to output voltage perturbations. There are limitations to the magnitude and the rate of change of the transient current that the MicroRAM can sustain while the converter responds. See Figures 8 – 16, on pp. 6 and 7, for examples of dynamic performance. A larger headroom voltage setting will provide increased transient performance, ripple attenuation and power dissipation while reducing overall efficiency (see Figures 4a, 4b, 4c and 4d on p. 5).

FUNCTIONAL DESCRIPTION (CONT.)

The active loop senses the output current and reduces the headroom voltage in a linear fashion to approximate constant power dissipation of MicroRAM with increasing loads (see Figures 5, 6 & 7, p. 6). The headroom setting can be reduced to decrease power dissipation where the transient requirement is low and efficient ripple attenuation is the primary performance concern.

The active dynamic headroom range is limited on the low end by the initial headroom setting and the maximum expected load. If the maximum load in the application is 10 Amps, for example, the 1 Amp headroom can be set 75mV lower to conserve power and still have active headroom at the maximum load current of 10 Amps. The high end or maximum headroom range is limited by the internal OR'ing diode function.

The SC or trim-up function can be used when remote sensing is not available on the source converter or is not desirable. It is specifically designed for converters with a 1.23 Volt reference and a 1k ohm input impedance like Vicor Maxi, Mini, Micro converters. In comparison to remote sensing, the SC configuration will have an error in the load voltage versus load current. It will be proportional to the output current and the resistance of the load path from the output of the MicroRAM to the load.

APPLICATION NOTES

Load capacitance can affect the overall phase margin of the MicroRAM active loop as well as the phase margin of the converter loop. The distributed variables such as inductance of the load path, the capacitor type and value as well as its ESR and ESL also affect transient capability at the load. The following guidelines should be considered when point of load capacitance is used with the MicroRAM in order to maintain a minimum of 30 degrees of phase margin.

- 1) Using ceramic load capacitance with < 1milliohm ESR and < 1nH ESL:
 - (a) 20 μ F to 200 μ F requires 20 nH of trace/wire load path inductance
 - (b) 200 μ F to 1,000 μ F requires 60 nH of trace/wire load path inductance

The OR'ing feature prevents current flowing from the output of the MicroRAM back through it's input terminal in a redundant system configuration in the event that a converter output fails. When the converter output supplying the MicroRAM droops below the OR'ed output voltage potential of the redundant system, the input of the MicroRAM is isolated from it's output. Less than 50mA will flow out of the input terminal of the MicroRAM over the full range of input voltage under this condition.

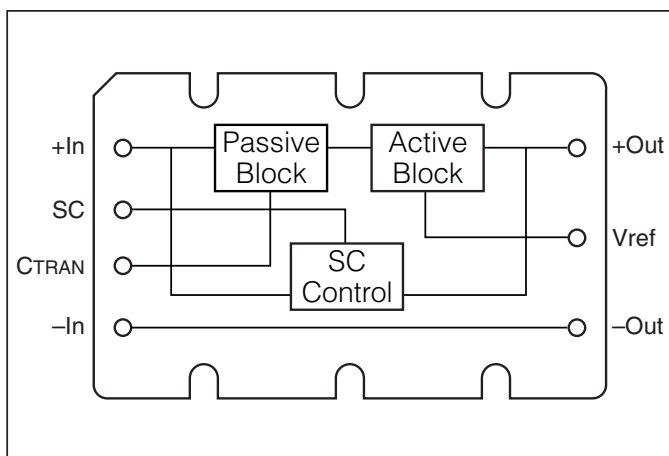

Block Diagram

- 2) For the case where load capacitance is connected directly to the output of the MicroRAM, i.e. no trace inductance, and the ESR is >1 milliohm:
 - (a) 20 μ F to 200 μ F load capacitance needs an ESL of >50 nH
 - (b) 200 μ F to 1,000 μ F load capacitance needs an ESL of >5 nH
- 3) Adding low ESR capacitance directly at the output terminals of MicroRAM is not recommended and may cause stability problems.
- 4) In practice the distributed board or wire inductance at a load or on a load board will be sufficient to isolate the output of the MicroRAM from any load capacitance and minimize any appreciable effect on phase margin.

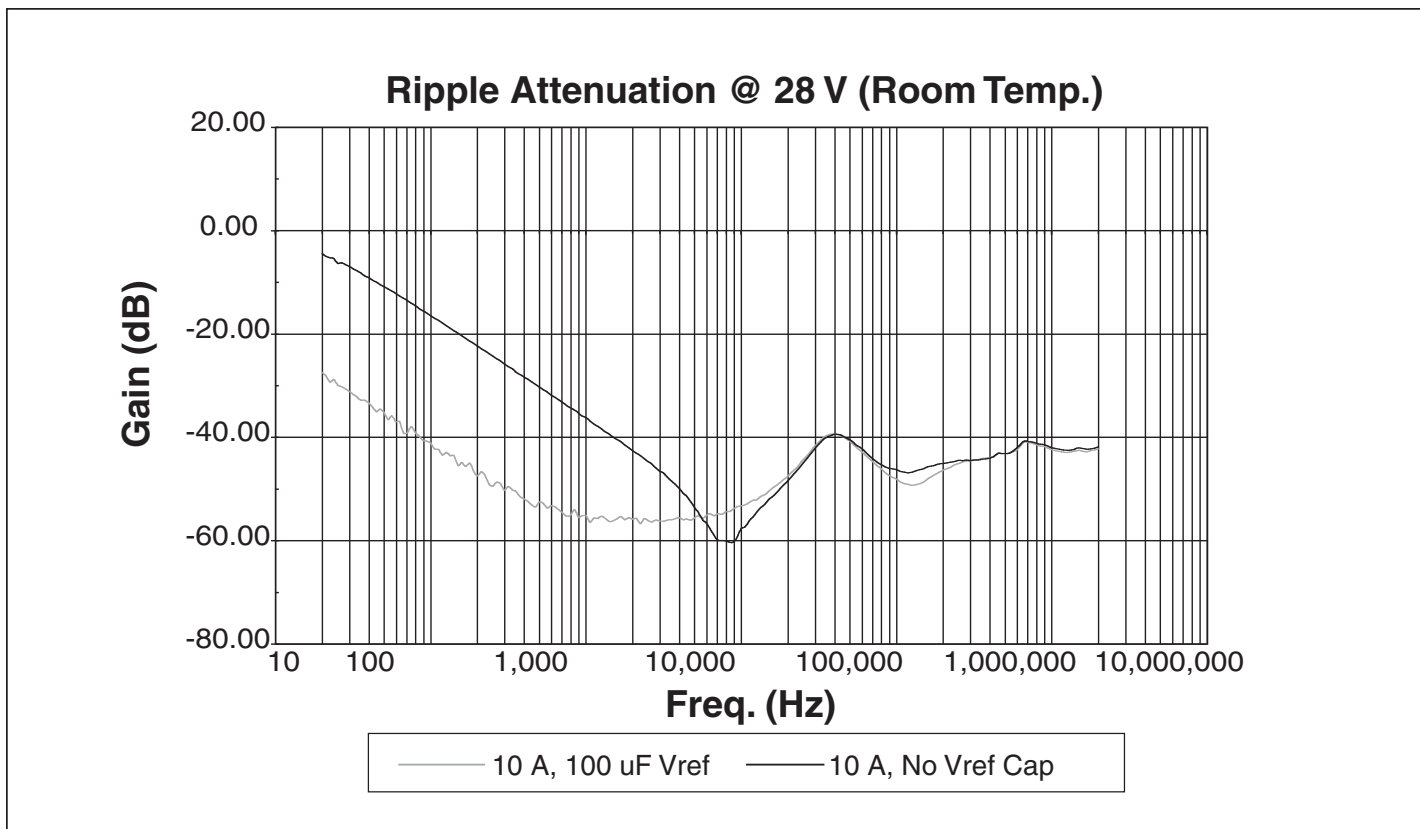

Figure 3a

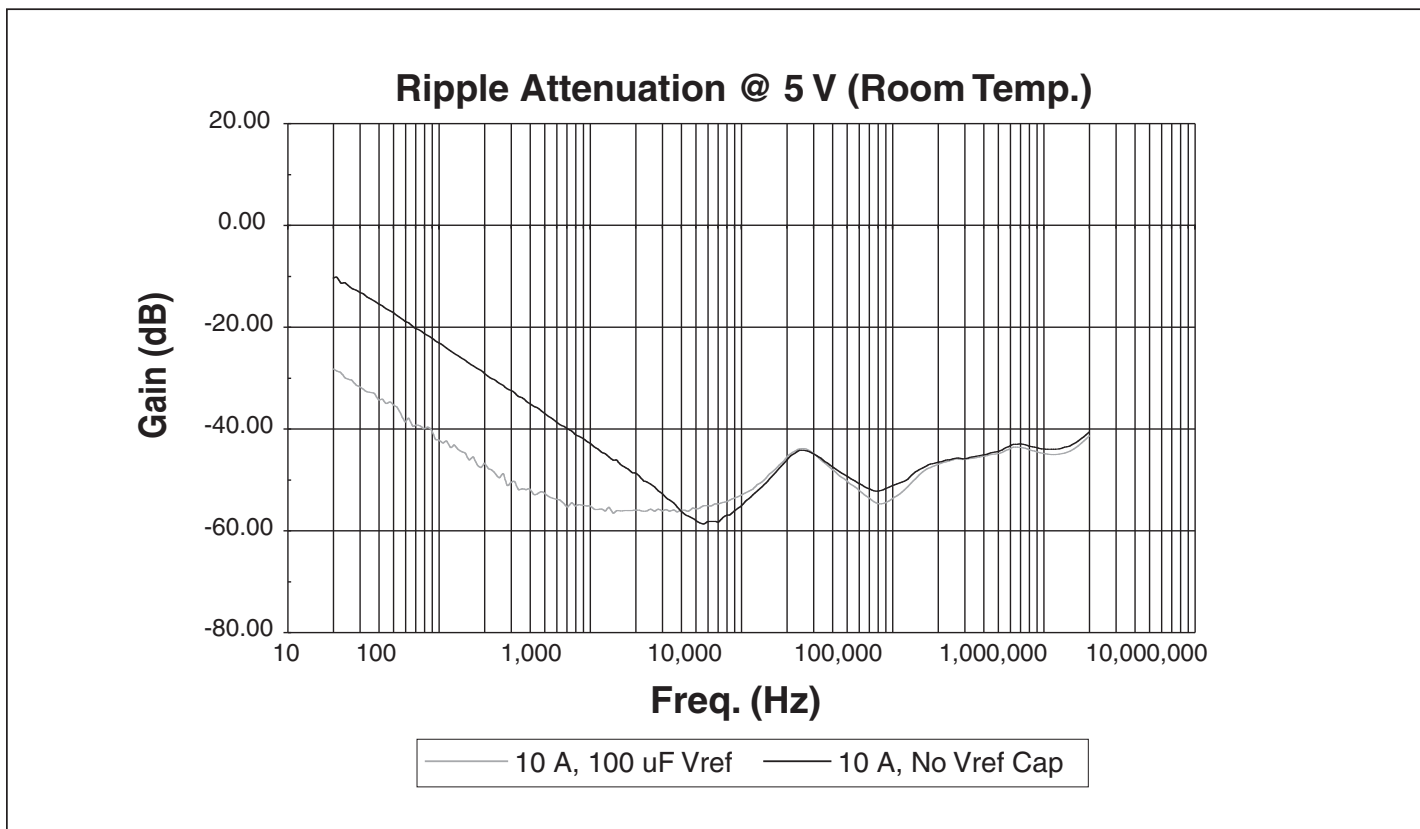

Figure 3a, 3b — Curves demonstrating the small signal attenuation performance as measured on a network analyzer with a typical module at (a) 28 V and 10 A output and (b) 5 V and 10 A. The low frequency attenuation can be enhanced by connecting a 100 μF capacitor, CHR, to the VREF pin as shown in Figures 1 and 2.

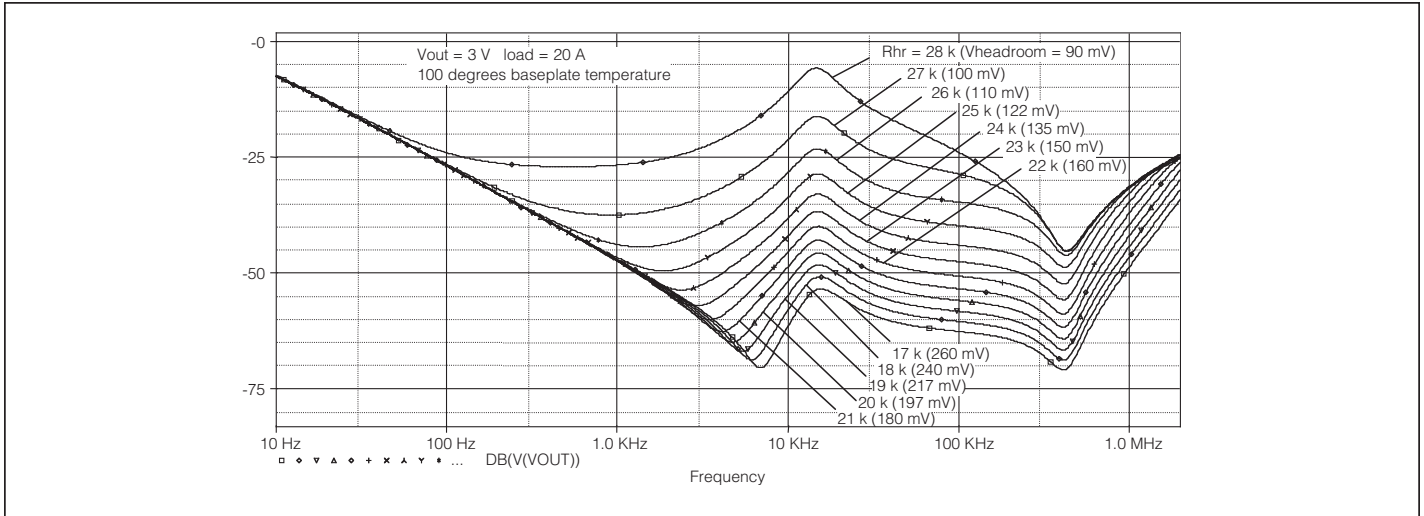

Figure 4a

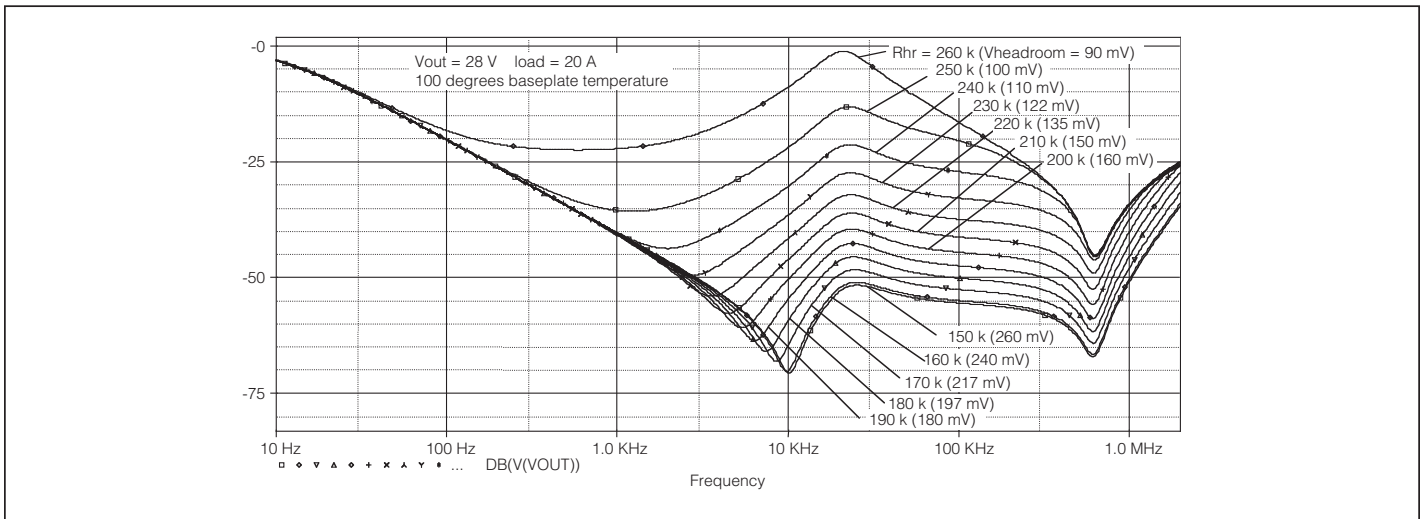

Figure 4a — 4b — Simulated graphs demonstrating the tradeoff of attenuation versus headroom setting at 20 Amps and an equivalent 100°C baseplate temperature at 3 V and 28 V.

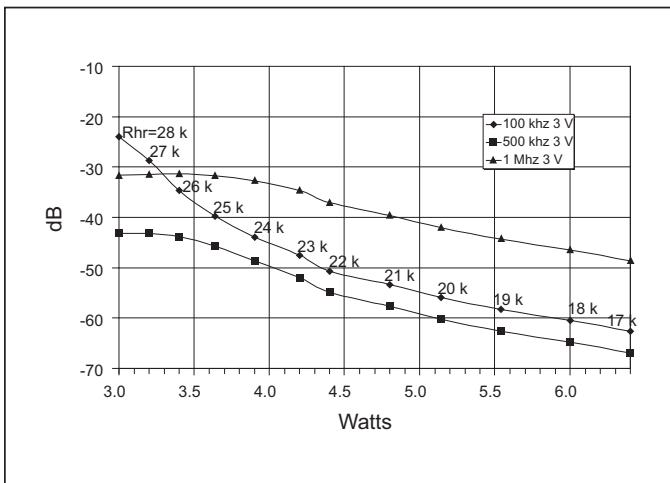

Figure 4c

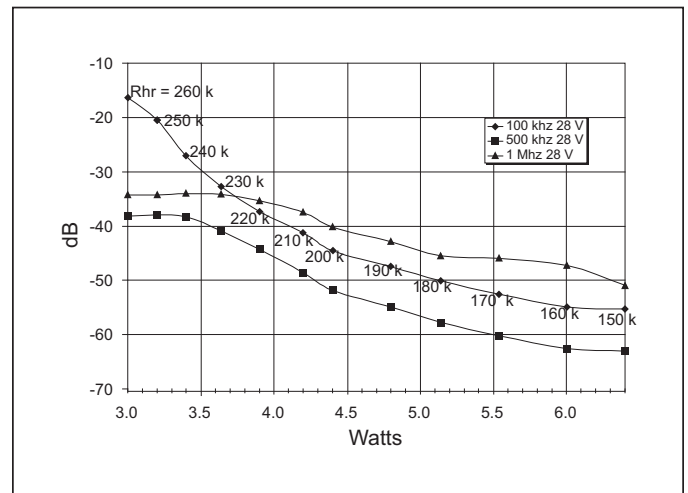

Figure 4c — 4d — MicroRam attenuation vs. power dissipation at 3 V 20 A, and 28 V 20 A.

μRAM2xxx (*μRAM3xxx data not included in this rev.*)

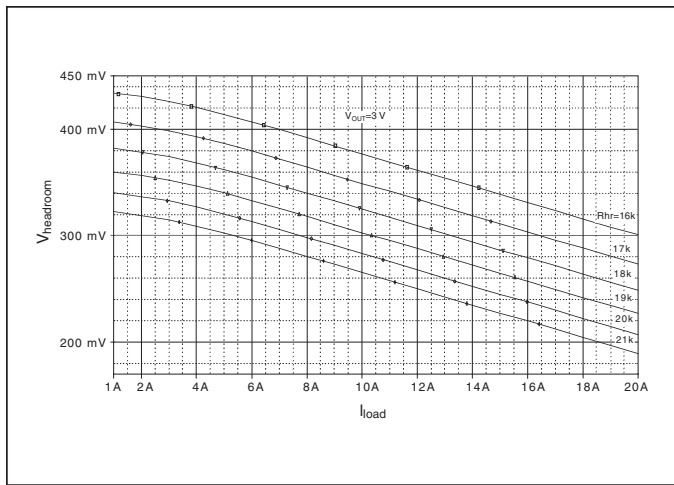

Figure 5 — Headroom vs. load current at 3 V output.

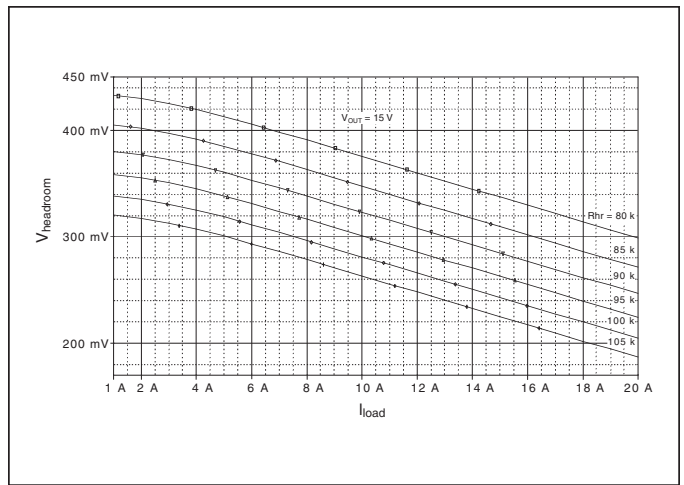

Figure 6 — Headroom vs. load current at 15 V output.

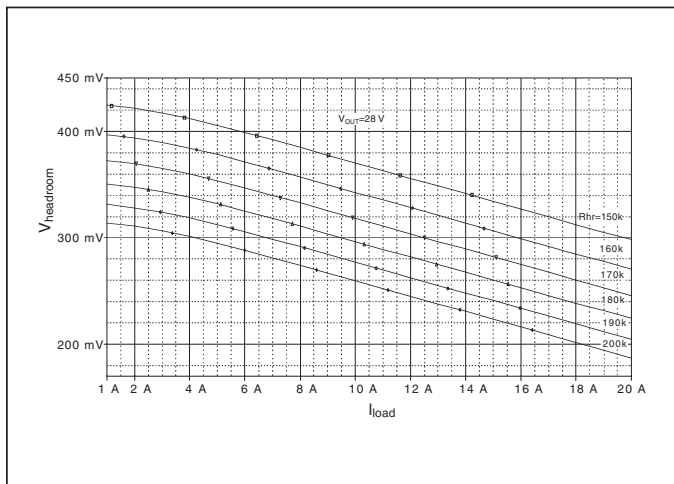

Figure 7 — Headroom vs. load current at 28 V output.

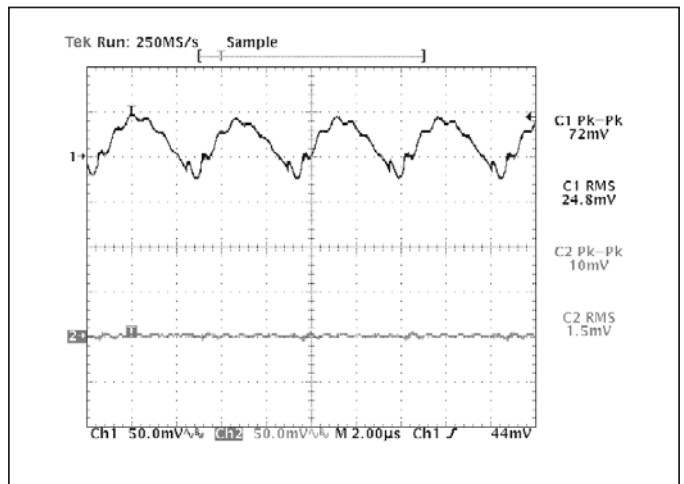

Figure 8 — V375A28C600B and μRAM; Input and output ripple @50% (10 A) load CH1=Vi; CH2=Vo; Vi-Vo=332 mV; RHR=178 k

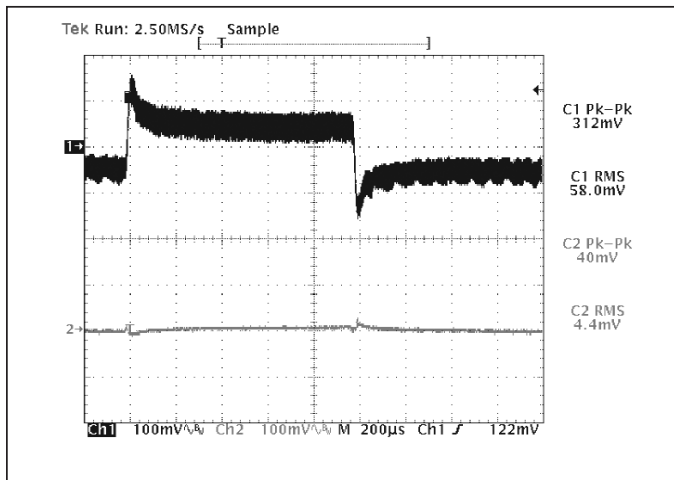

Figure 9 — V375A28C600B and μRAM; Input and output dynamic response no added C_{TRAN}; 20% of 20 A rating load step of 4 A (10 A – 14 A);R_{HR} = 178 k (Configured as in Figs. 1 & 2)

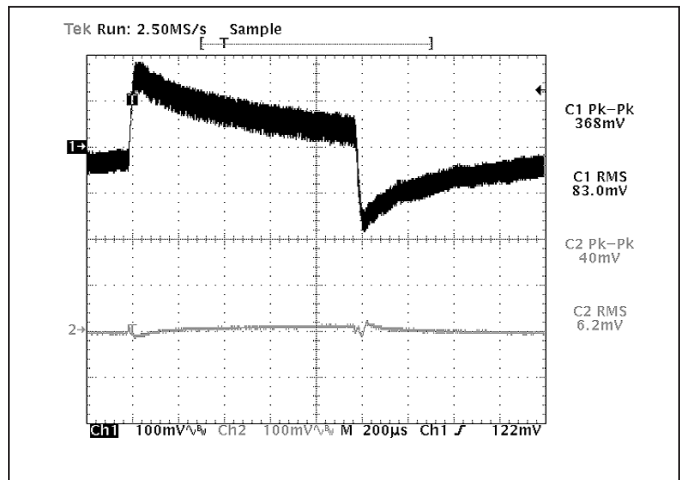

Figure 10 — V375A28C600B and μRAM; Input and output dynamic response C_{TRAN}=820 μF Electrolytic; 32.5% of load step of 6.5 A (10 A – 16.5 A);R_{HR}=178 k (Configured as in Figs. 1 & 2)

Notes: The measurements in Figures 8-16 were taken with a μRAM2C21 and standard scope probes with a 20MHz bandwidth scope setting. The criteria for transient current capability was as follows: The transient load current step was incremented from 10A to the peak value indicated, then stepped back to 10A until the resulting output peak to peak was around 40mV.

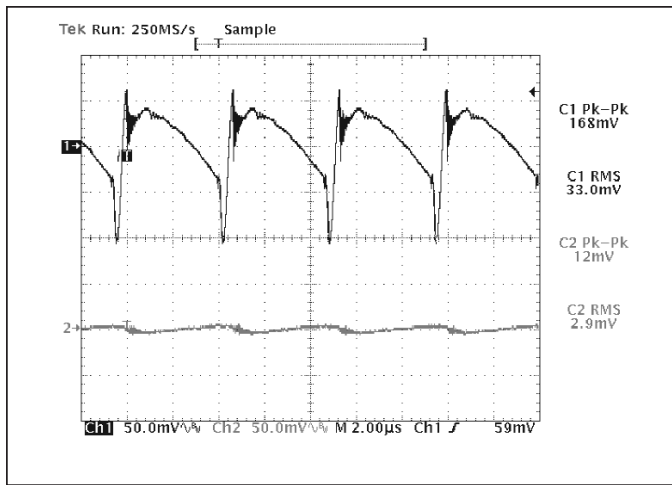

Figure 11 — V375B12C250B and μRAM; Input and output ripple@50% (10 A) load CH1=Vi; CH2=Vo; Vi-Vo=305mV; RHR=80k (Configured as in Figs. 1 & 2)

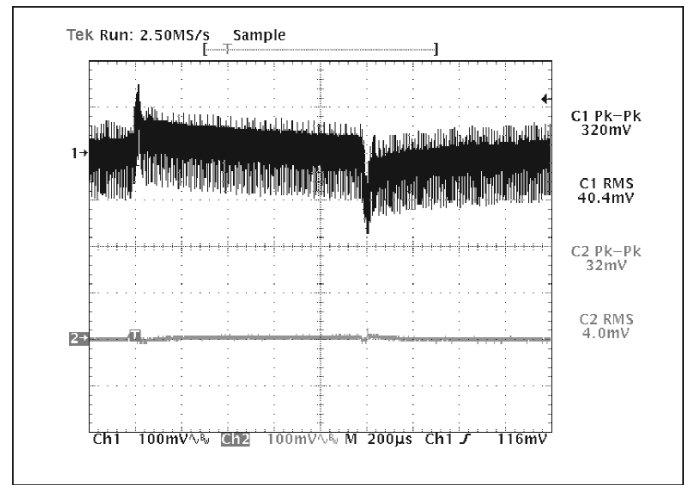

Figure 12 — V300B12C250B and μRAM; Input and output dynamic response no added C_{TRAN}; 17.5% of 20 A rating load step of 3.5 A (10 A – 13.5 A);RHR=80 k (Configured as in Figs. 1 & 2)

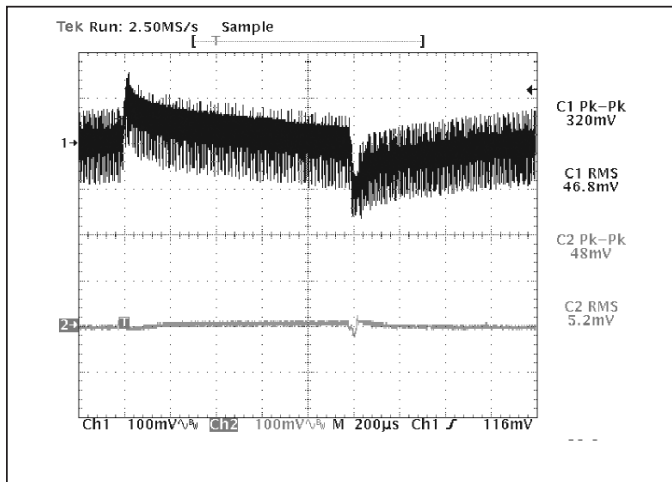

Figure 13 — V300B12C250B and μRAM; Input and output dynamic response C_{TRAN} = 820 μF Electrolytic; 30% of load step of 6 A (10 A – 16 A);RHR=80 k (Configured as in Figs. 1 & 2)

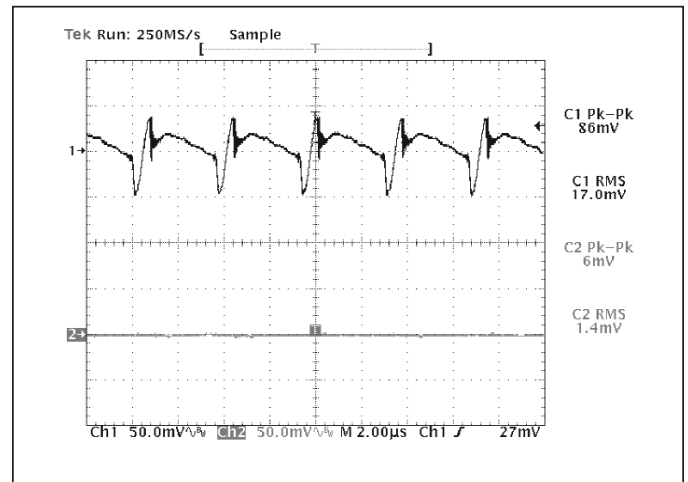

Figure 14 — V48C5C100B and μRAM; Input and output ripple @50% (10 A) load CH1=Vi; CH2=Vo; Vi-Vo=327mV; RHR=31k (Configured as in Figs. 1 & 2)

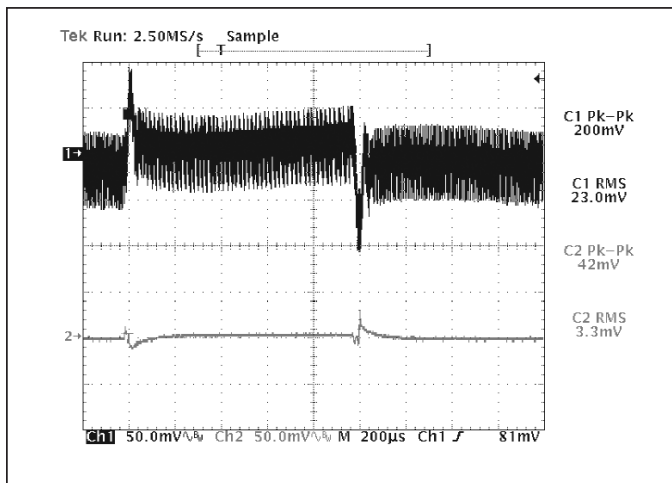

Figure 15 — V48C5C100B and μRAM; Input and output dynamic response no added C_{TRAN}; 22.5% of 20 A rating load step of 4.5 A (10 A – 14.5 A);RHR=31k (Configured as in Figs. 1 & 2)

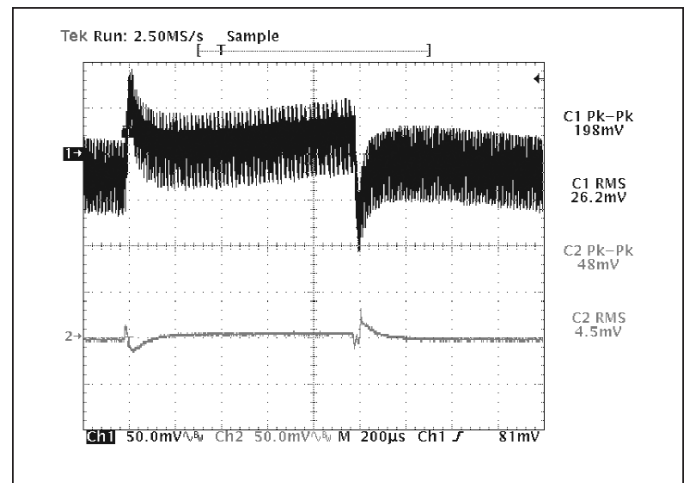

Figure 16 — V48C5C100B and μRAM; Input and output dynamic response C_{TRAN}=820 μF Electrolytic; 35% of load step of 7 A (10 A – 17 A);RHR=31 k (Configured as in Figs. 1 & 2)

MECHANICAL DRAWINGS

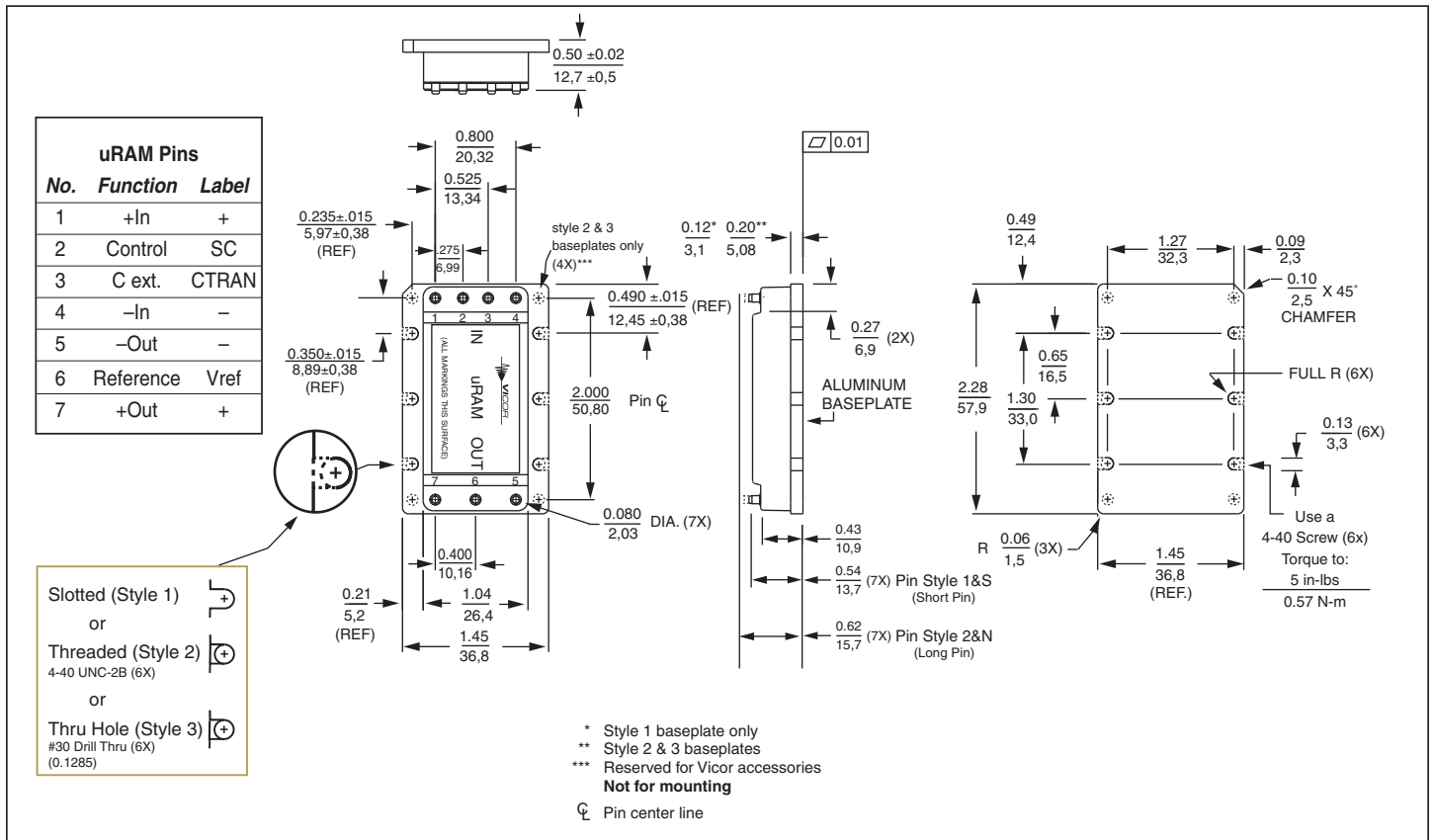

Figure 17 — Module outline

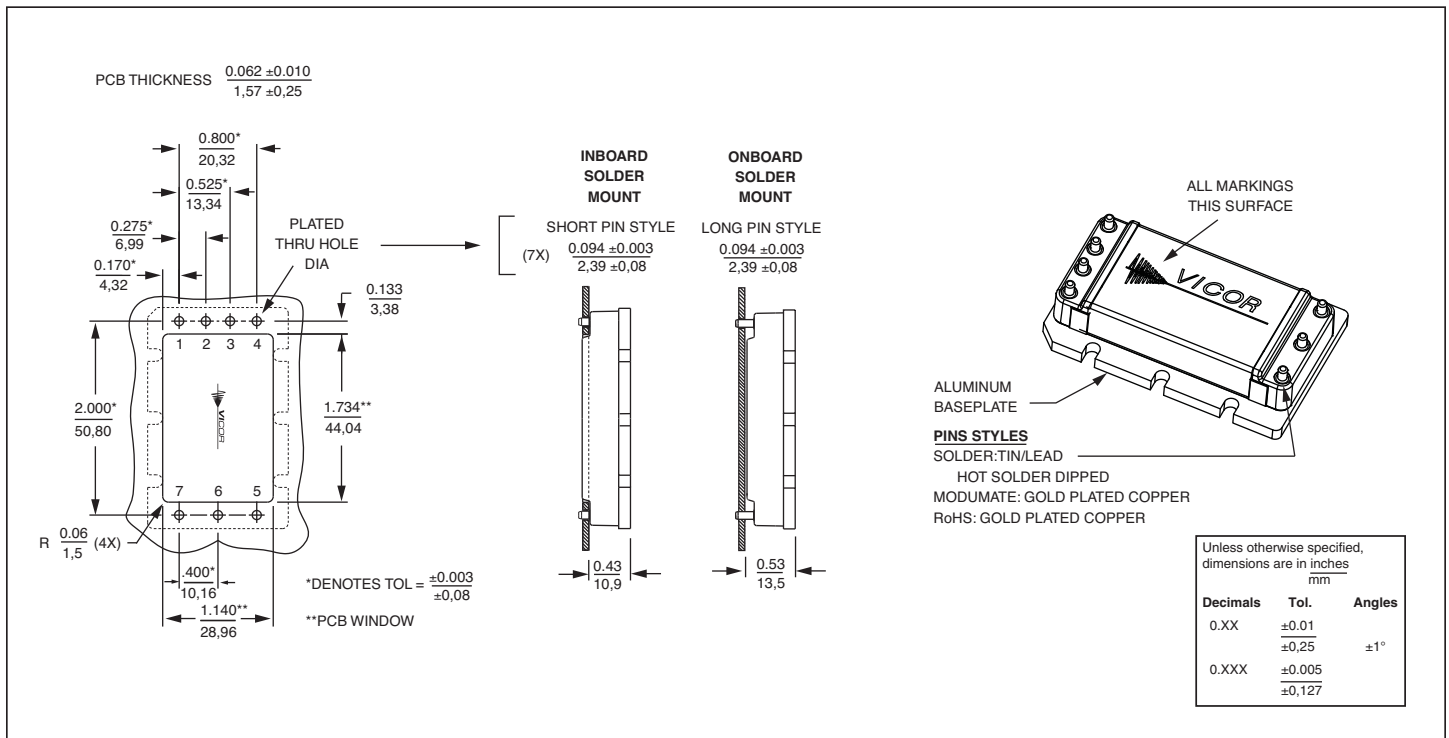

Figure 18 — PCB mounting specifications

Warranty

Vicor products are guaranteed for two years from date of shipment against defects in material or workmanship when in normal use and service. This warranty does not extend to products subjected to misuse, accident, or improper application or maintenance. Vicor shall not be liable for collateral or consequential damage. This warranty is extended to the original purchaser only.

EXCEPT FOR THE FOREGOING EXPRESS WARRANTY, VICOR MAKES NO WARRANTY, EXPRESS OR IMPLIED, INCLUDING, BUT NOT LIMITED TO, THE WARRANTY OF MERCHANTABILITY OR FITNESS FOR A PARTICULAR PURPOSE.

Vicor will repair or replace defective products in accordance with its own best judgement. For service under this warranty, the buyer must contact Vicor to obtain a Return Material Authorization (RMA) number and shipping instructions. Products returned without prior authorization will be returned to the buyer. The buyer will pay all charges incurred in returning the product to the factory. Vicor will pay all reshipment charges if the product was defective within the terms of this warranty.

Information published by Vicor has been carefully checked and is believed to be accurate; however, no responsibility is assumed for inaccuracies. Vicor reserves the right to make changes to any products without further notice to improve reliability, function, or design. Vicor does not assume any liability arising out of the application or use of any product or circuit; neither does it convey any license under its patent rights nor the rights of others. Vicor general policy does not recommend the use of its components in life support applications wherein a failure or malfunction may directly threaten life or injury. Per Vicor Terms and Conditions of Sale, the user of Vicor components in life support applications assumes all risks of such use and indemnifies Vicor against all damages.

Vicor's comprehensive line of power solutions includes high density AC-DC and DC-DC modules and accessory components, fully configurable AC-DC and DC-DC power supplies, and complete custom power systems.

Information furnished by Vicor is believed to be accurate and reliable. However, no responsibility is assumed by Vicor for its use. Vicor components are not designed to be used in applications, such as life support systems, wherein a failure or malfunction could result in injury or death. All sales are subject to Vicor's Terms and Conditions of Sale, which are available upon request.

Specifications are subject to change without notice.

Intellectual Property Notice

Vicor and its subsidiaries own Intellectual Property (including issued U.S. and Foreign Patents and pending patent applications) relating to the products described in this data sheet. Interested parties should contact Vicor's Intellectual Property Department.

Vicor Corporation
25 Frontage Road
Andover, MA, USA 01810
Tel: 800-735-6200
Fax: 978-475-6715

email

Customer Service: custserv@vicorpower.com
Technical Support: apps@vicorpower.com