

1MBI600NP-060

1MBI600NN-060

IGBT Module

600V / 600A 1 in one-package

■ Features

- High speed switching
- Voltage drive
- Low inductance module structure

■ Applications

- Inverter for Motor drive
- AC and DC Servo drive amplifier
- Uninterruptible power supply
- Industrial machines, such as Welding machines



■ Maximum ratings and characteristics

● Absolute maximum ratings (at Tc=25°C unless otherwise specified)

Item	Symbol	Rating	Unit
Collector-Emitter voltage	V _{CEs}	600	V
Gate-Emitter voltage	V _{GES}	±20	V
Collector current	Continuous	I _c	600 A
	1ms pulse	I _c pulse	1200 A
	Continuous	-I _c	600 A
	1ms pulse	-I _c pulse	1200 A
Max. power dissipation	P _c	2000	W
Operating temperature	T _j	+150	°C
Storage temperature	T _{stg}	-40 to +125	°C
Isolation voltage	V _{is}	AC 2500 (1min.)	V
Screw torque	Mounting *1	3.5	N·m
	Terminals *2	4.5	N·m
	Terminals *3	1.7	N·m

*1: Recommendable value : 2.5 to 3.5 N·m(M5) or (M6)

*2: Recommendable value : 3.5 to 4.5 N·m(M6)

*3: Recommendable value : 1.3 to 1.7 N·m(M4)

● Electrical characteristics (at T_j=25°C unless otherwise specified)

Item	Symbol	Characteristics			Conditions	Unit
		Min.	Typ.	Max.		
Zero gate voltage collector current	I _{CEs}	–	–	4.0	V _{GE} =0V, V _{CE} =600V	mA
Gate-Emitter leakage current	I _{GES}	–	–	60	V _{CE} =0V, V _{GE} =±20V	µA
Gate-Emitter threshold voltage	V _{GE(th)}	4.5	–	7.5	V _{CE} =20V, I _c =600mA	V
Collector-Emitter saturation voltage	V _{CE(sat)}	–	–	2.8	V _{GE} =15V, I _c =600A	V
Input capacitance	C _{ies}	–	39600	–	V _{GE} =0V	pF
Output capacitance	C _{oes}	–	8800	–	V _{CE} =10V	
Reverse transfer capacitance	C _{res}	–	4000	–	f=1MHz	
Turn-on time	t _{on}	–	0.6	1.2	V _{CC} =300V	µs
	t _r	–	0.2	0.6	I _c =600A	
Turn-off time	t _{off}	–	0.6	1.0	V _{GE} =±15V	
	t _f	–	0.2	0.35	R _G =2.7 ohm	
Diode forward on voltage	V _F	–	–	3.0	I _F =600A, V _{GE} =0V	V
Reverse recovery time	t _{rr}	–	–	0.3	I _F =600A	µs

● Thermal resistance characteristics

Item	Symbol	Characteristics			Conditions	Unit
		Min.	Typ.	Max.		
Thermal resistance	R _{th(j-c)}	–	–	0.063	IGBT	°C/W
	R _{th(j-c)}	–	–	0.11	Diode	°C/W
	R _{th(c-f)} *4	–	0.0125	–	the base to cooling fin	°C/W

*4: This is the value which is defined mounting on the additional cooling fin with thermal compound

■ Equivalent Circuit Schematic

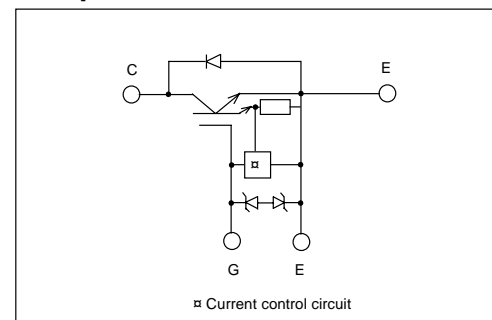

■ Characteristics (Representative)

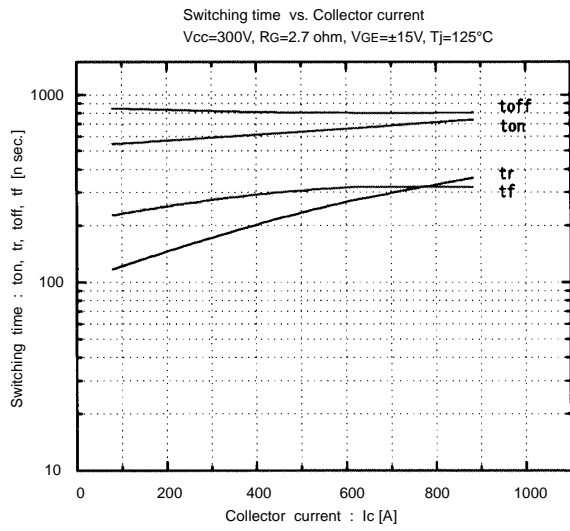
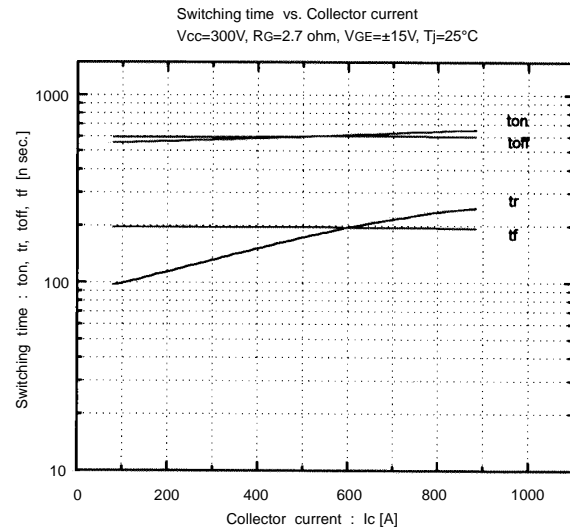
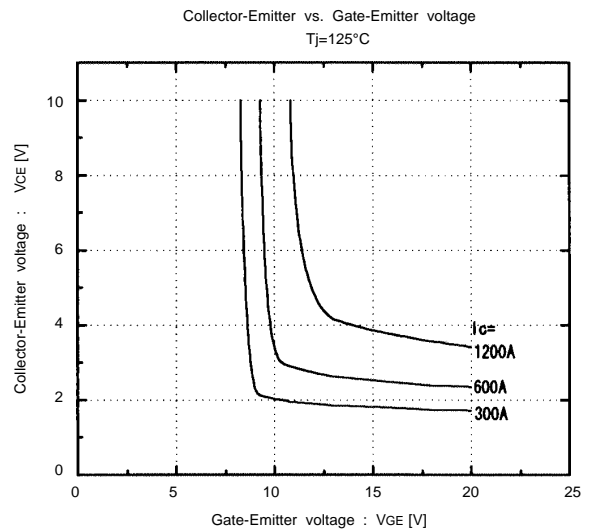
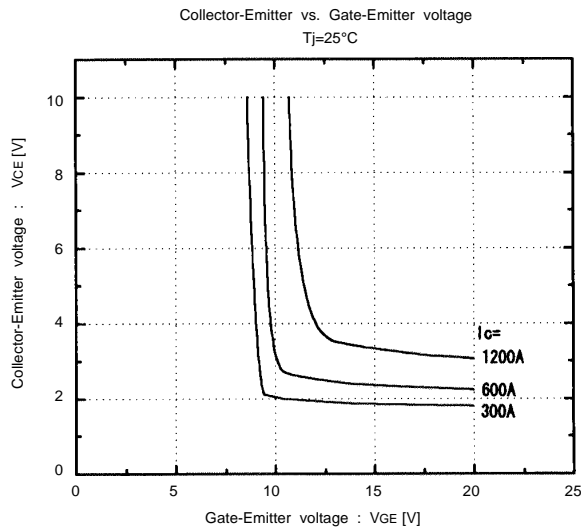
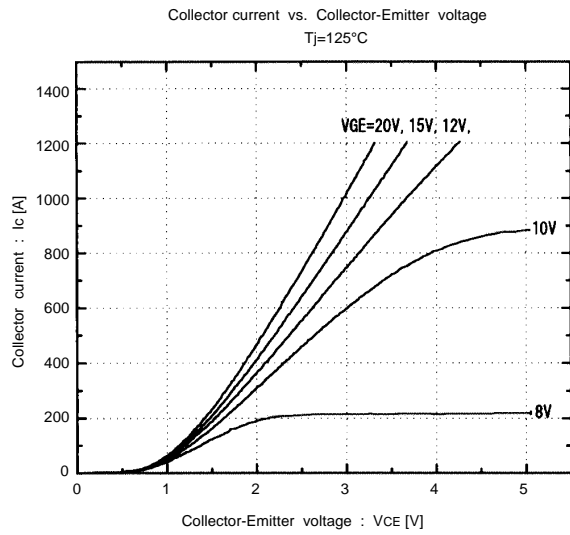
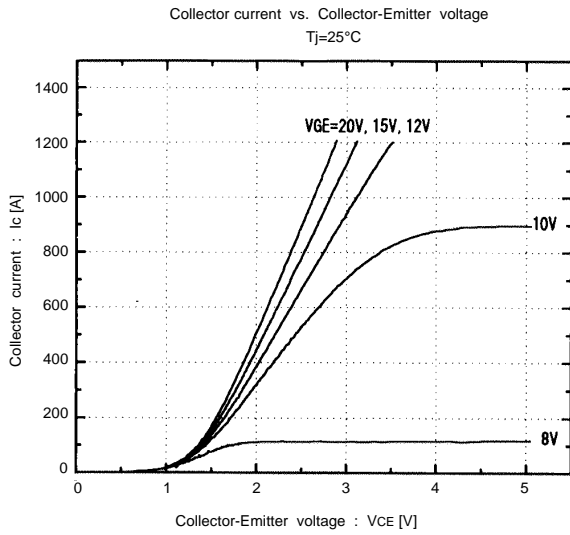

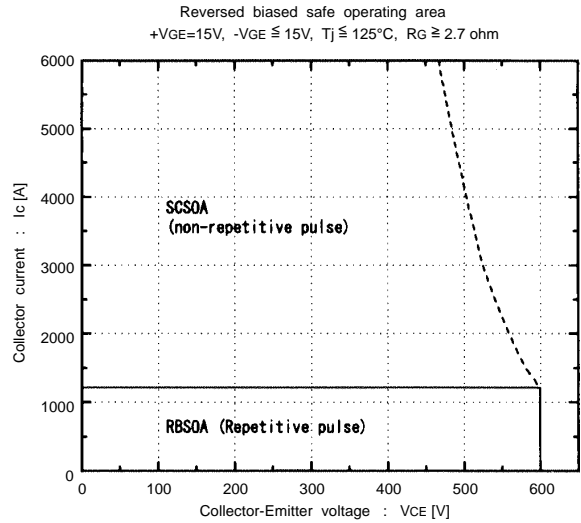
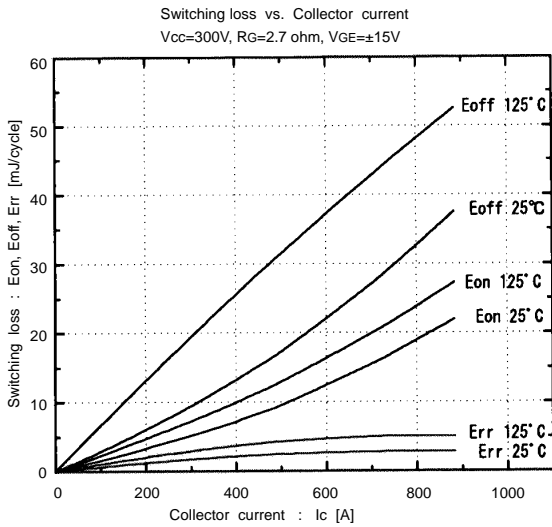
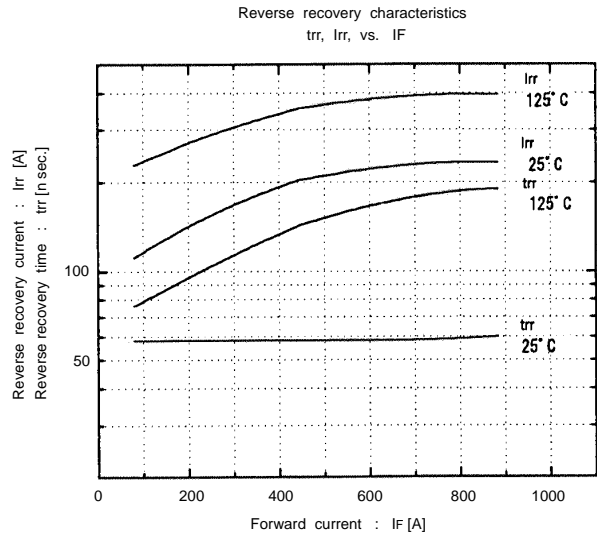
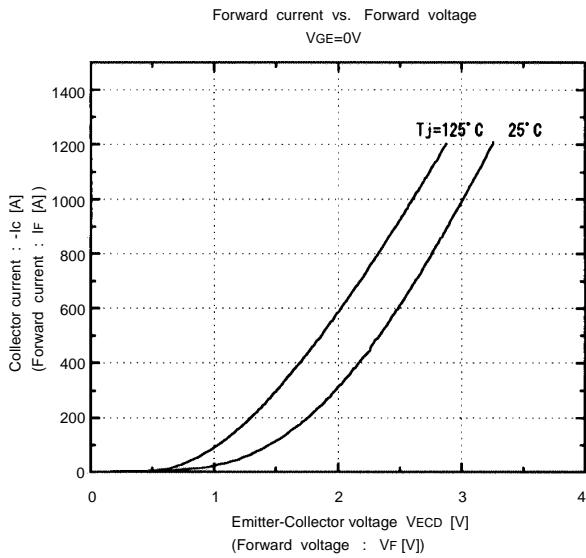
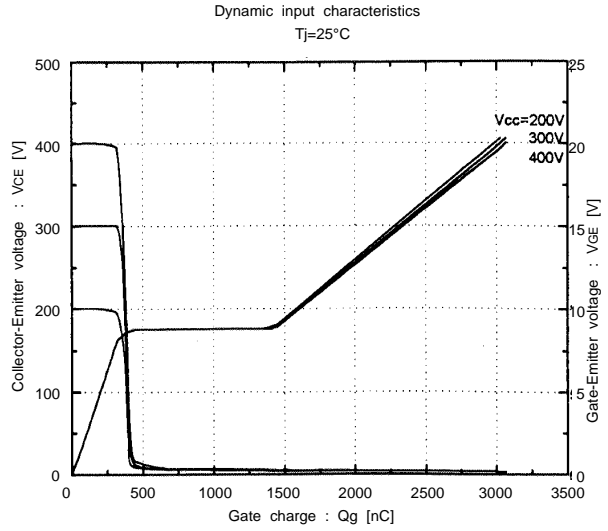
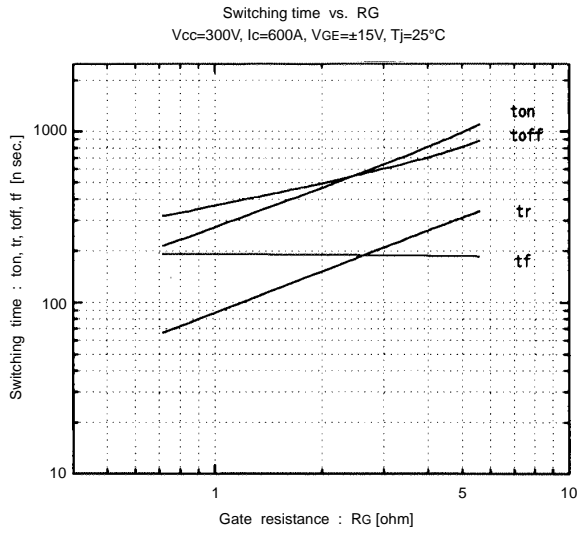

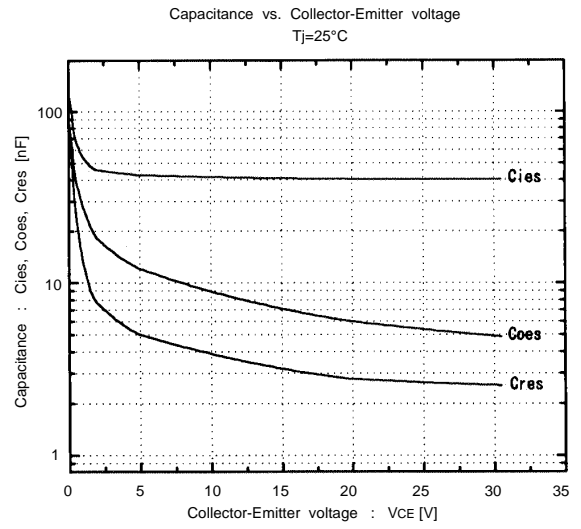
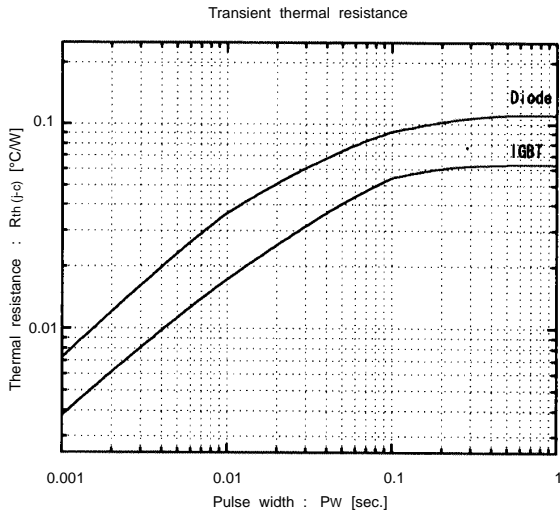

■ Outline Drawings, mm

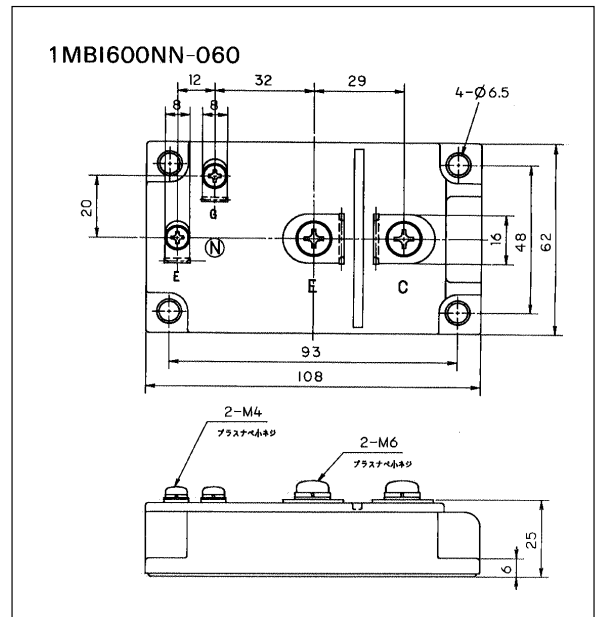
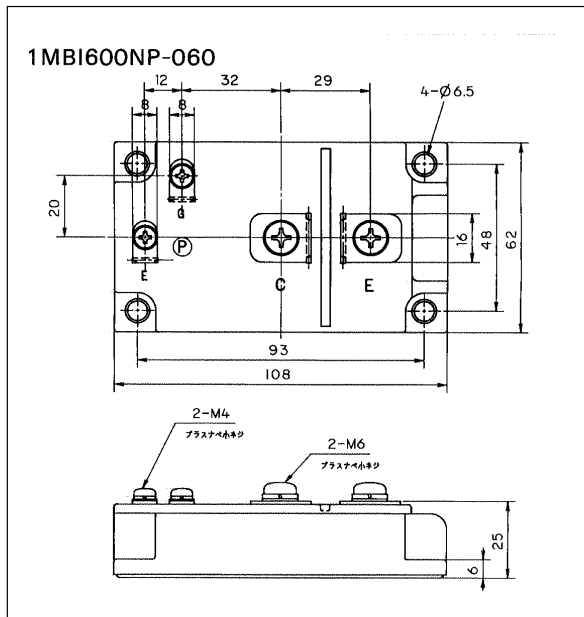

mass : 370g