

MOSFET MODULE

FCA50CC50



UL;E76102(M)

FCA50CC50 is a dual power MOSFET module designed for fast switching applications of high voltage and current. (2 devices are serial connected with a fast recovery diode ($t_{rr} \leq 100\text{ns}$) reverse connected across each MOSFET.) The mounting base of the module is electrically isolated from semiconductor elements for simple heatsink construction.

- $I_D = 50\text{A}$, $V_{DS} = 500\text{V}$
- Suitable for high speed switching applications.
- Low ON resistance.
- Wide Safe Operating Areas.
- $t_{rr} \leq 100\text{ns}$ fast recovery diode for free wheel.

(Applications)

UPS(CVCF), Motor Control, Switching Power Supply, etc.

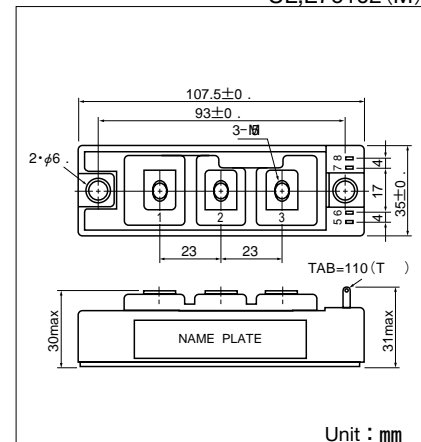
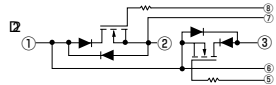

Unit : mm

Maximum Ratings

($T_j = 25^\circ\text{C}$ u n l)

Symbol	Item		Conditions	Ratings		Unit
				FCA50CC50		
V_{DS}	Drain-Source Voltage			500		V
V_{GS}	Gate-Source Voltage			± 20		V
I_D	Drain Current	DC	Duty 55%	50		A
I_{DP}		Pulse		100		
$-I_D$	Source Current			50		A
P_T	Total Power Dissipation		$T_c = 25^\circ\text{C}$	330		W
T_j	Channel Temperature			-40 t $+150$		$^\circ\text{C}$
T_{stg}	Storage Temperature			-40 t $+125$		$^\circ\text{C}$
V_{iso}	Isolation Voltage (R.M.S.)		A.C. 1minute	2500		V
	Mounting Torque	Mounting (M6)	Recommended Value 2.5-3.9 (25-40)	4.7 (48)		N·m (kgf·cm)
		Terminal (M5)	Recommended Value 1.5-2.5 (15-25)	2.7 (28)		
	Mass		Typical Value	240		g

Electrical Characteristics

($T_j = 25^\circ\text{C}$ u n l)

Symbol	Item		Conditions	Ratings			Unit
				Min.	Typ.	Max.	
I_{GSS}	Gate Leakage Current		$V_{GS} = \pm 20\text{V}$, $V_{DS} = 0\text{V}$			± 1.0	μA
I_{DSS}	Zero Gate Voltage Drain Current		$V_{GS} = 0\text{V}$, $V_{DS} = 500\text{V}$			1.0	mA
$V_{(BR)DS}$	Drain-Source Breakdown Voltage		$V_{GS} = 0\text{V}$, $I_D = 1\text{mA}$	500			V
$V_{GS(th)}$	Gate-Source Threshold Voltage		$V_{DS} = V_{GS}$, $I_D = 10\text{mA}$	1.0		5.0	V
$R_{DS(on)}$	Drain-Source On-State Resistance		$I_D = 25\text{A}$, $V_{GS} = 15\text{V}$			140	m Ω
$V_{DS(on)}$	Drain-Source On-State Voltage		$I_D = 25\text{A}$, $V_{GS} = 15\text{V}$			3.5	V
g_{fs}	Forward Transconductance		$V_{DS} = 10\text{V}$, $I_D = 25\text{A}$		30		S
C_{iss}	Input Capacitance		$V_{GS} = 0\text{V}$, $V_{DS} = 25\text{V}$, $f = 1.0\text{MHz}$			10000	pF
C_{oss}	Output Capacitance		$V_{GS} = 0\text{V}$, $V_{DS} = 25\text{V}$, $f = 1.0\text{MHz}$			1900	pF
C_{rss}	Reverse Transfer Capacitance		$V_{GS} = 0\text{V}$, $V_{DS} = 25\text{V}$, $f = 1.0\text{MHz}$			750	pF
$t_{d(on)}$	Switching Time	Turn-on Delay Time	$V_{DD} = 300\text{V}$, $V_{GS} = 15\text{V}$ $I_D = 25\text{A}$, $R_G = 5\Omega$		60		ns
t_r		Rise Time			100		
$t_{d(off)}$		Turn-off Delay Time			520		
t_f		Fall Time			140		
V_{SDS}	Diode Forward Voltage		$I_S = 25\text{A}$, $V_{GS} = 0\text{V}$			2.0	V
t_{rr}	Reverse Recovery Time		$I_S = 25\text{A}$, $V_{GS} = -5\text{V}$, $di/dt = 100\text{A}/\mu\text{s}$		80	100	ns
$R_{th(j-c)}$	Thermal Resistance		MOSFET			0.38	$^\circ\text{C}/\text{W}$
			Diode			1.67	

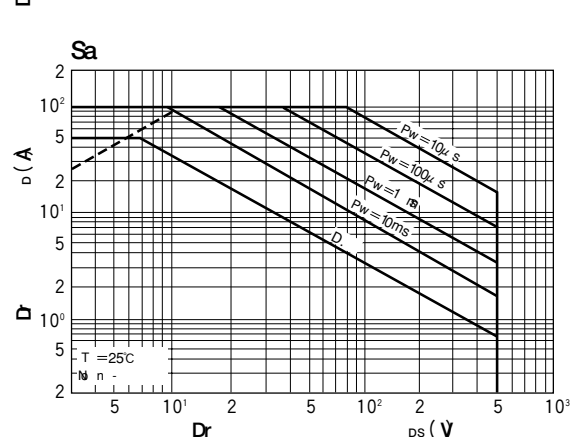
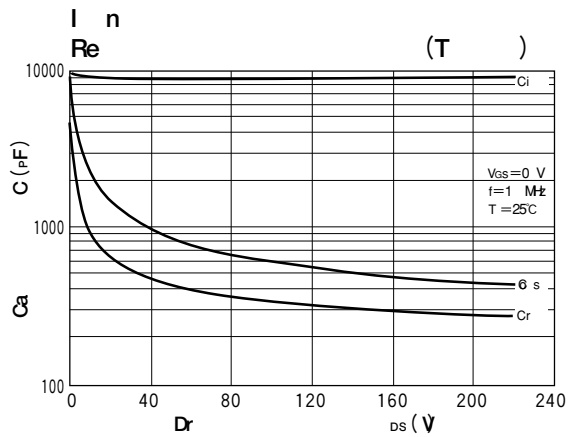
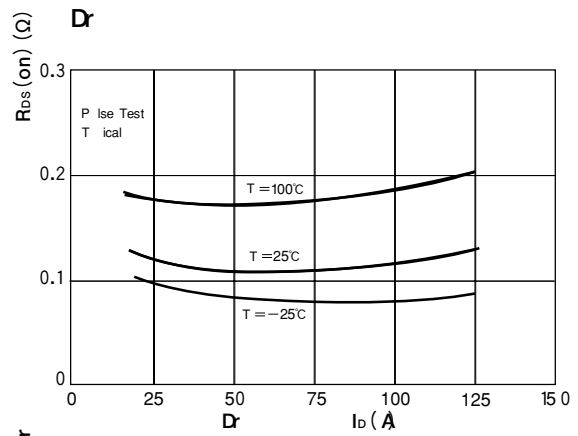
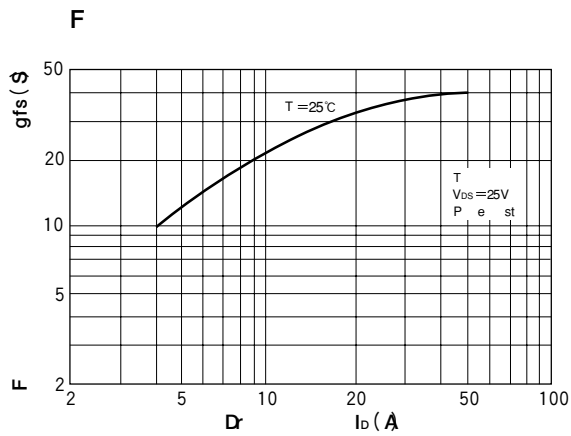
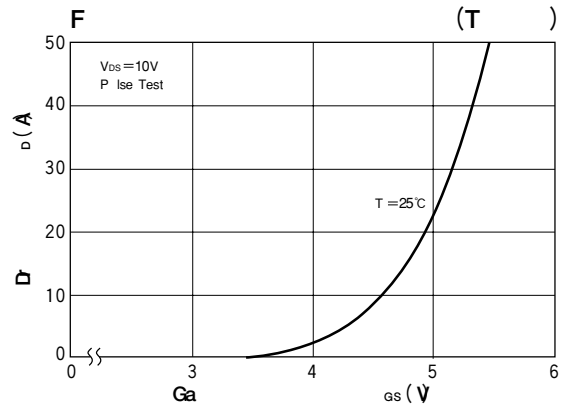
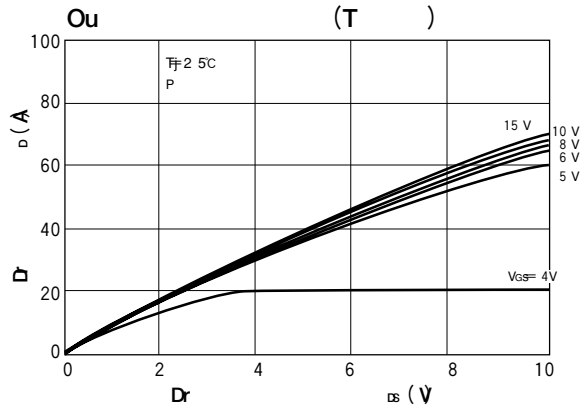

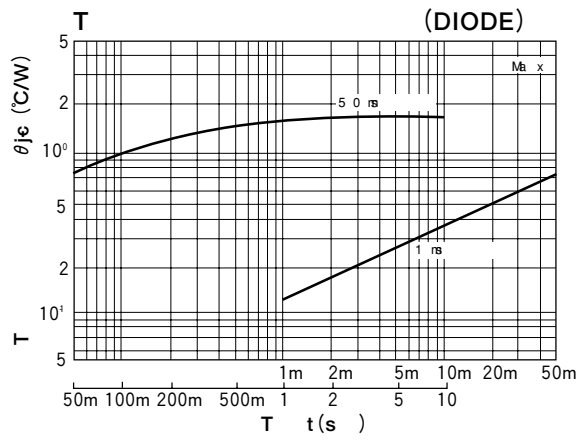
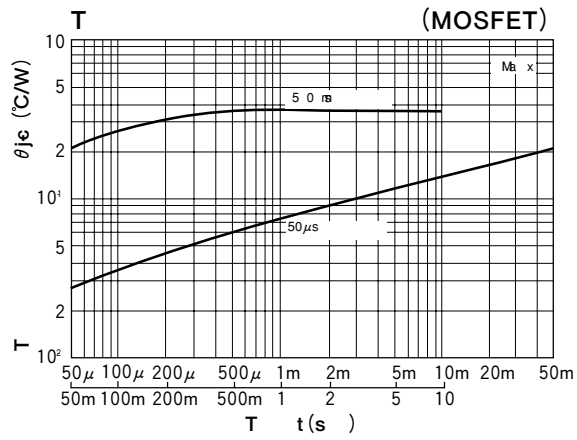
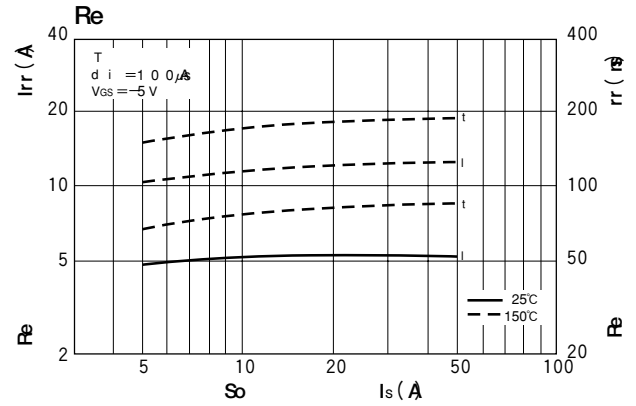
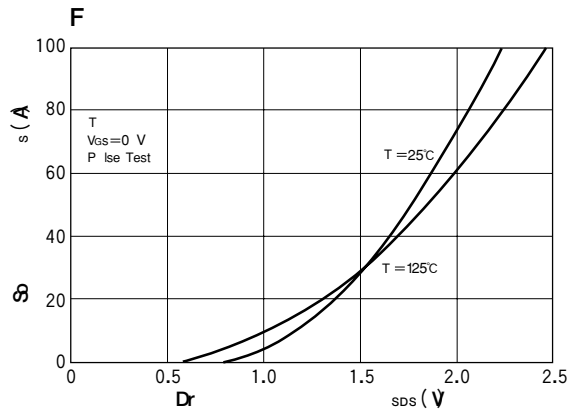

MOSFET MODULE

FCA75CC50



UL:E76102(M)

FCA75CC50 is a dual power MOSFET module designed for fast switching applications of high voltage and current. (2 devices are serial connected with a fast recovery diode ($t_{rr} \leq 100\text{ns}$) reverse connected across each MOSFET.) The mounting base of the module is electrically isolated from semiconductor elements for simple heatsink construction.

- $I_D = 75\text{A}$, $V_{DS} = 500\text{V}$
- Suitable for high speed switching applications.
- Low ON resistance.
- Wide Safe Operating Areas.
- $t_{rr} \leq 100\text{ns}$ fast recovery diode for free wheel.

(Applications)

UPS(CVCF), Motor Control, Switching Power Supply, etc.

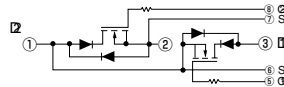
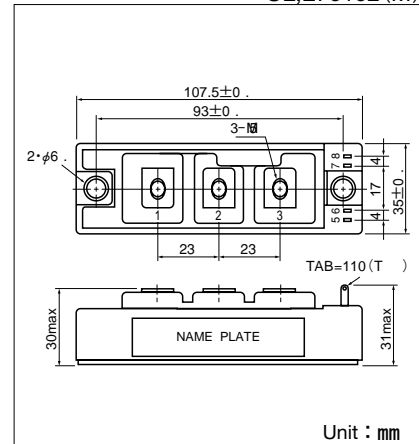

Maximum Ratings

($T_j = 25^\circ\text{C}$ u n l)

Symbol	Item		Conditions	Ratings		Unit
				FCA75CC50		
V_{DS}	Drain-Source Voltage			500		V
V_{GS}	Gate-Source Voltage			± 20		V
I_D	Drain Current	DC	Duty 35%	75		A
I_{DP}		Pulse		150		
$-I_D$	Source Current			75		A
P_T	Total Power Dissipation		$T_c = 25^\circ\text{C}$	430		W
T_j	Channel Temperature			-40 t $+ 150$		$^\circ\text{C}$
T_{stg}	Storage Temperature			-40 t $+ 125$		$^\circ\text{C}$
V_{iso}	Isolation Voltage (R.M.S.)		A.C. 1minute	2500		V
	Mounting Torque	Mounting (M6)	Recommended Value 2.5-3.9 (25-40)	4.7 (48)		N·m (kgf·cm)
		Terminal (M5)	Recommended Value 1.5-2.5 (15-25)	2.7 (28)		
	Mass		Typical Value	240		g

Electrical Characteristics

($T_j = 25^\circ\text{C}$)

Symbol	Item		Conditions	Ratings			Unit
				Min.	Typ.	Max.	
I_{GSS}	Gate Leakage Current		$V_{GS} = \pm 20\text{V}$, $V_{DS} = 0\text{V}$			± 1.0	μA
I_{DSS}	Zero Gate Voltage Drain Current		$V_{GS} = 0\text{V}$, $V_{DS} = 500\text{V}$			1.0	mA
$V_{(BR)DS}$	Drain-Source Breakdown Voltage		$V_{GS} = 0\text{V}$, $I_D = 1\text{mA}$	500			V
$V_{GS(th)}$	Gate-Source Threshold Voltage		$V_{DS} = V_{GS}$, $I_D = 10\text{mA}$	1.0		5.0	V
$R_{DS(on)}$	Drain-Source On-State Resistance		$I_D = 40\text{A}$, $V_{GS} = 15\text{V}$			110	m Ω
$V_{DS(on)}$	Drain-Source On-State Voltage		$I_D = 40\text{A}$, $V_{GS} = 15\text{V}$			4.4	V
g_{fs}	Forward Transconductance		$V_{DS} = 10\text{V}$, $I_D = 40\text{A}$		40		S
C_{iss}	Input Capacitance		$V_{GS} = 0\text{V}$, $V_{DS} = 25\text{V}$, $f = 1.0\text{MHz}$			13500	pF
C_{oss}	Output Capacitance		$V_{GS} = 0\text{V}$, $V_{DS} = 25\text{V}$, $f = 1.0\text{MHz}$			2500	pF
C_{rss}	Reverse Transfer Capacitance		$V_{GS} = 0\text{V}$, $V_{DS} = 25\text{V}$, $f = 1.0\text{MHz}$			1000	pF
$t_{d(on)}$	Switching Time	Turn-on Delay Time	$V_{DD} = 300\text{V}$, $V_{GS} = 15\text{V}$ $I_D = 40\text{A}$, $R_G = 5\Omega$		70		ns
t_r		Rise Time			140		
$t_{d(off)}$		Turn-off Delay Time			700		
t_f		Fall Time			210		
V_{SDS}	Diode Forward Voltage		$-I_S = 40\text{A}$, $V_{GS} = 0\text{V}$			2.5	V
t_{rr}	Reverse Recovery Time		$-I_S = 40\text{A}$, $V_{GS} = -5\text{V}$, $di/dt = 100\text{A}/\mu\text{s}$		80	100	ns
$R_{th(j-c)}$	Thermal Resistance		MOSFET			0.29	$^\circ\text{C}/\text{W}$
			Diode			1.67	

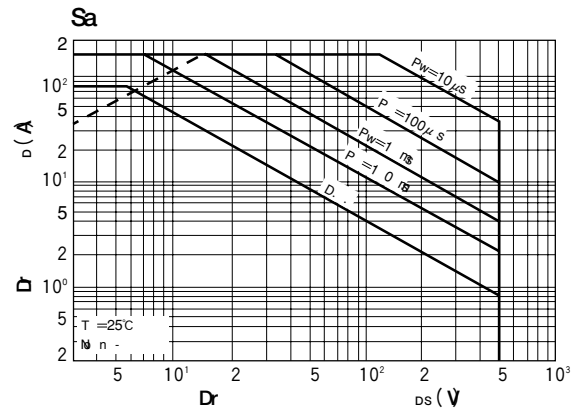
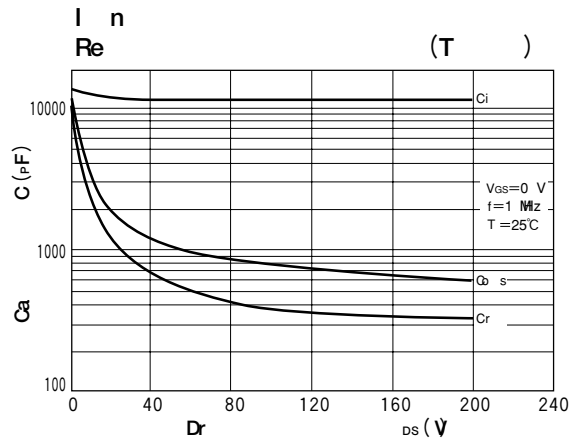
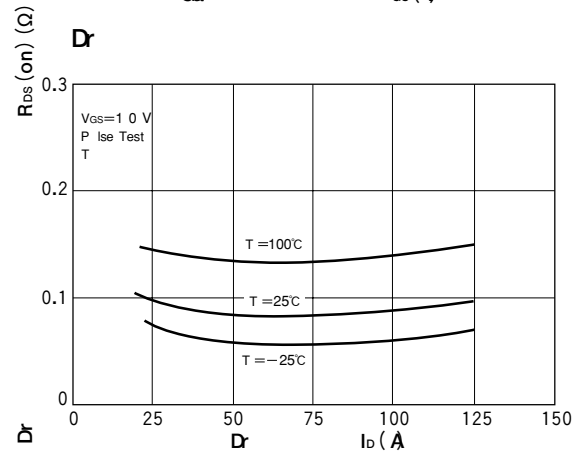
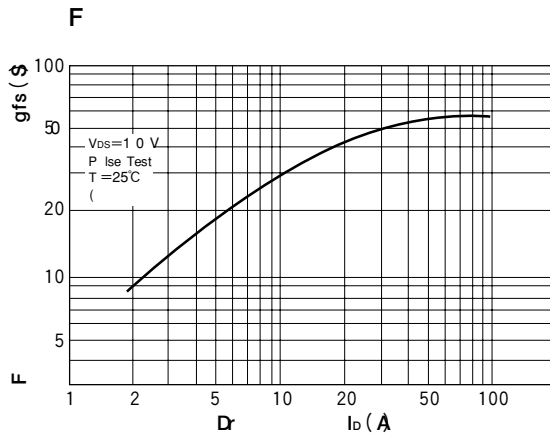
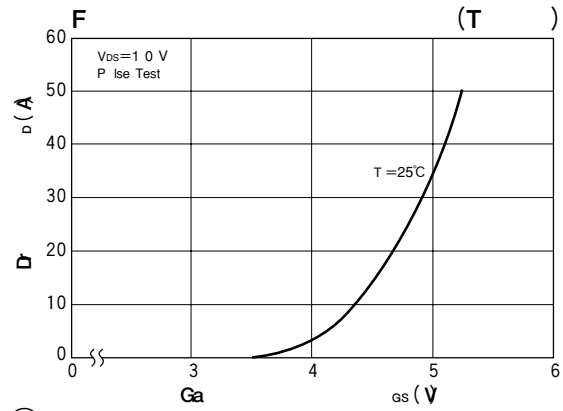
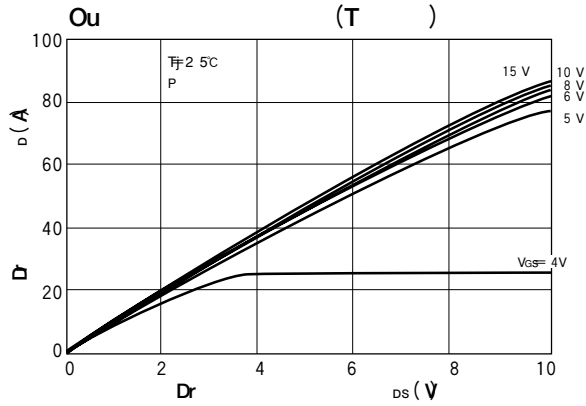

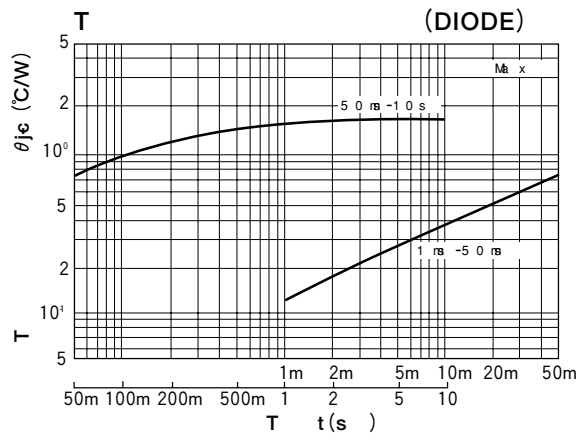
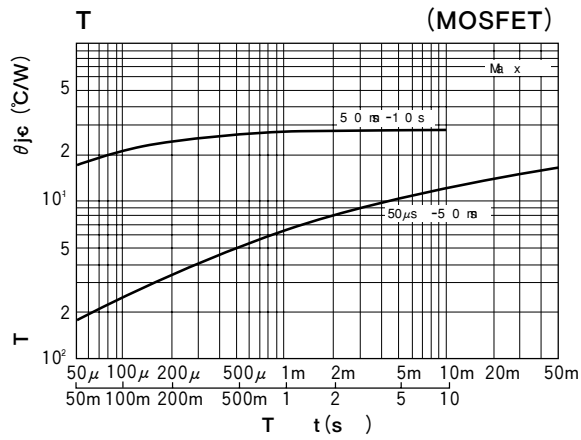
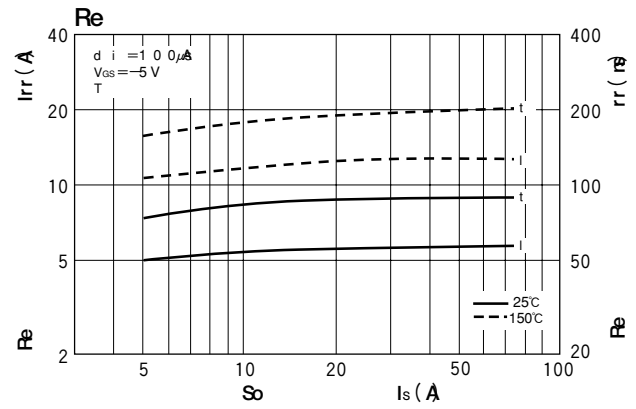
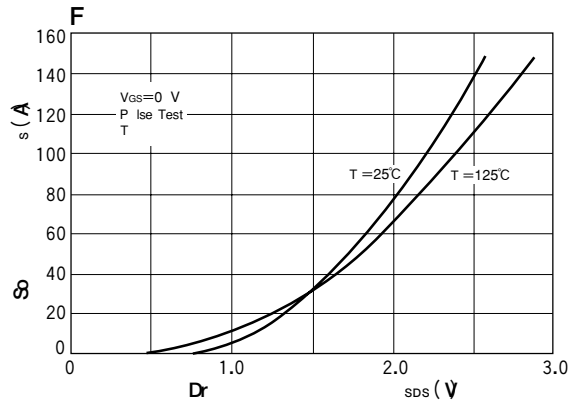

MOSFET MODULE

FBA50CA45/50



UL;E76102(M)

FBA50CA45/50 is a dual power MOSFET module designed for fast switching applications of high voltage and current. (2 devices are serial connected.) The mounting base of the module is electrically isolated from semiconductor elements for simple heatsink construction.

- $I_D=50A$, $V_{DSS}=500V$
- Suitable for high speed switching applications.
- Low ON resistance.
- Wide Safe Operating Areas.

(Applications)

UPS(CVCF), Motor Control, Switching Power Supply, etc.

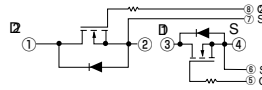
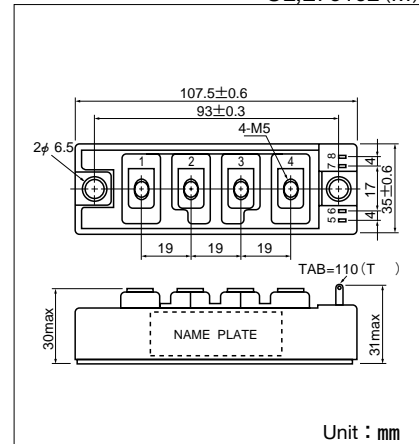

Unit : mm

■ **Maximum Ratings**

($T_j=25^\circ\text{C}$ u n l)

Symbol	Item		Conditions	Ratings		Unit
				FBA50CA45	FBA50CA50	
V_{DSS}	Drain-Source Voltage			450	500	V
V_{GS}	Gate-Source Voltage			± 20		V
I_D	Drain Current	D.C.		50		A
I_{DP}		Pulse		100		
$-I_D$	Source Current			50		A
P_T	Total Power Dissipation		$T_c=25^\circ\text{C}$	320		W
T_j	Channel Temperature			150		$^\circ\text{C}$
T_{stg}	Storage Temperature			-40 t + 125		$^\circ\text{C}$
V_{iso}	Isolation Voltage (R.M.S.)		A.C. 1minute	2500		V
	Mounting Torque	Mounting (M6)	Recommended Value 2.5-3.9 (25-40)	4.7 (48)		N·m (kgf·cm)
		Terminal (M5)	Recommended Value 1.5-2.5 (15-25)	2.7 (28)		
	Mass		Typical Value	220		g

■ **Electrical Characteristics**

($T_j=25^\circ\text{C}$ u n l)

Symbol	Item		Conditions	Ratings			Unit
				Min.	Typ.	Max.	
I_{GSS}	Gate Leakage Current		$V_{GS}=\pm 20V$, $V_{DS}=0V$			± 1.0	μA
I_{DSS}	Zero Gate Voltage Drain Current		$V_{GS}=0V$, $V_{DS}=500V$			1.0	mA
$V_{(BR)DSS}$	Drain-Source Breakdown Voltage	FBA50CA45	$V_{GS}=0V$, $I_D=1mA$	450			V
		FBA50CA50		500			
$V_{GS(th)}$	Gate-Source Threshold Voltage		$V_{DS}=V_{GS}$, $I_D=10mA$	1.0		5.0	V
$R_{DS(on)}$	Drain-Source On-State Resistance		$I_D=25A$, $V_{GS}=15V$			120	m Ω
$V_{DS(on)}$	Drain-Source On-State Voltage		$I_D=25A$, $V_{GS}=15V$			3.0	V
g_{fs}	Forward Transconductance		$V_{DS}=10V$, $I_D=25A$		30		S
C_{iss}	Input Capacitance		$V_{GS}=0V$, $V_{DS}=25V$, $f=1.0MHz$			10000	pF
C_{oss}	Output Capacitance		$V_{GS}=0V$, $V_{DS}=25V$, $f=1.0MHz$			1900	pF
C_{rss}	Reverse Transfer Capacitance		$V_{GS}=0V$, $V_{DS}=25V$, $f=1.0MHz$			750	pF
$t_{d(on)}$	Switching Time	Turn-on Delay Time	$R_L=12\Omega$, $R_{GS}=50\Omega$, $V_{GS}=15V$ $I_D=25A$, $R_G=5\Omega$		60		ns
t_r		Rise Time			60		
$t_{d(off)}$		Turn-off Delay Time			650		
t_f		Fall Time			130		
V_{SDS}	Diode Forward Voltage		$-I_D=25A$, $V_{GS}=0V$			1.5	V
t_{rr}	Reverse Recovery Time		$-I_D=25A$, $V_{GS}=0V$, $di/dt=100A/\mu s$		700		ns
$R_{th(j-c)}$	Thermal Resistance					0.39	$^\circ\text{C}/W$

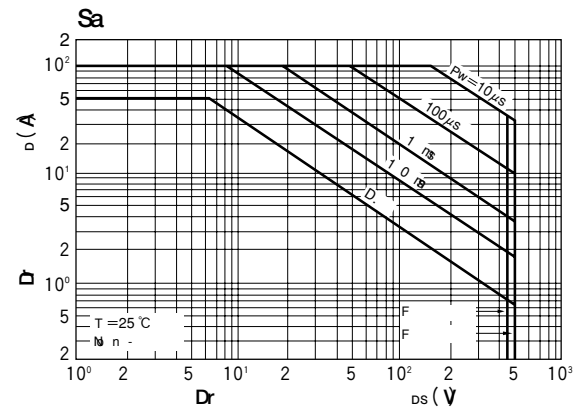
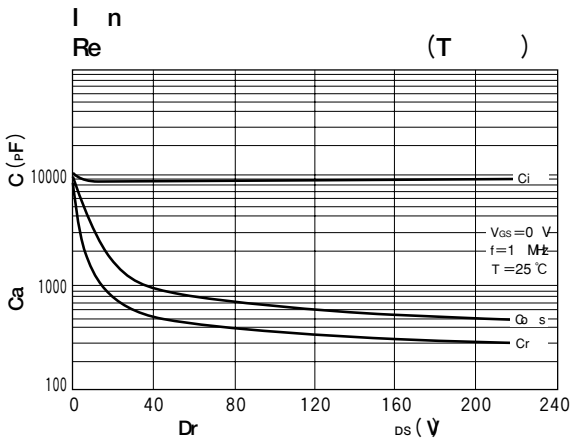
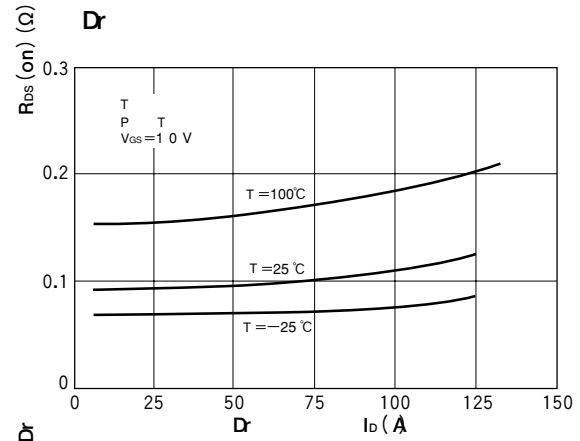
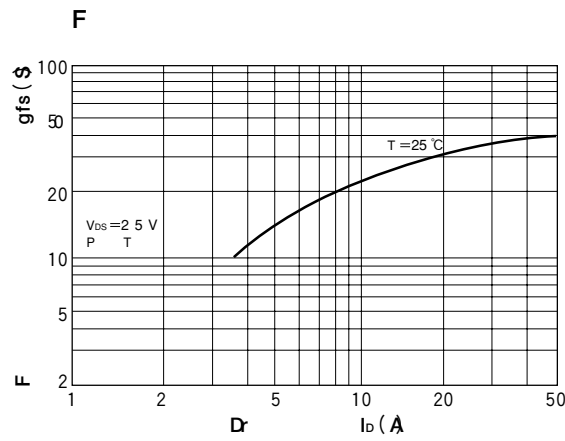
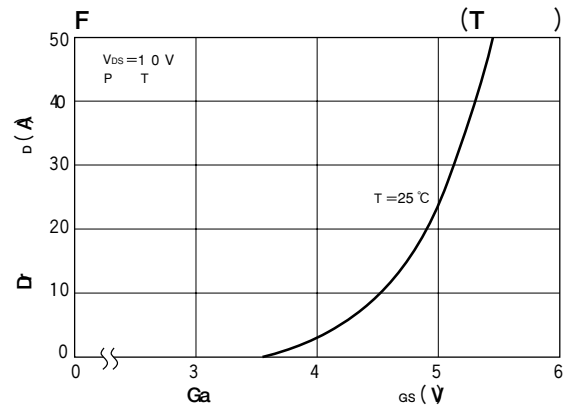
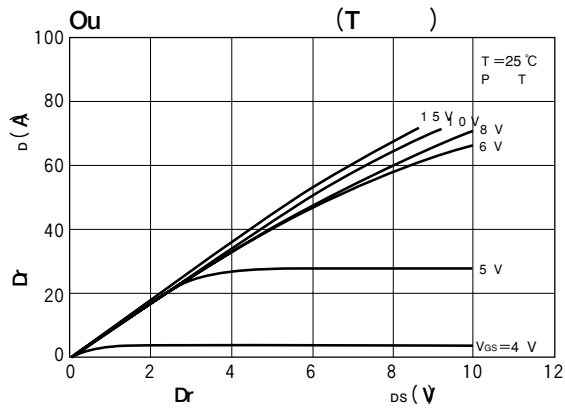

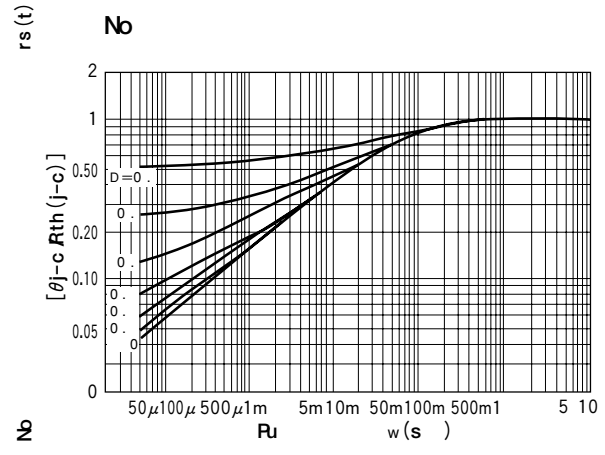
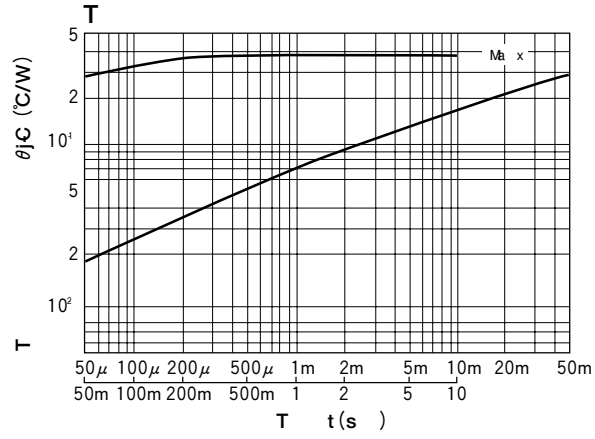
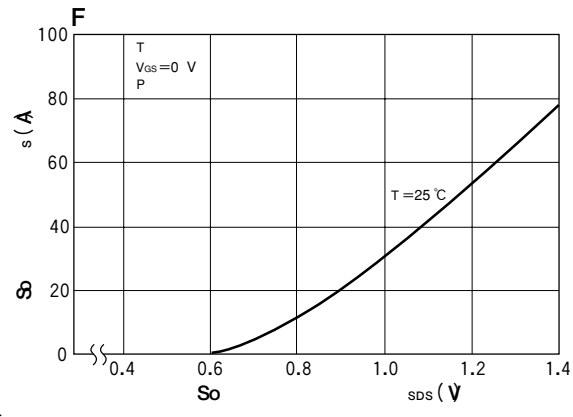

MOSFET MODULE

FBA75CA45/50



UL;E76102(M)

FBA75CA45/50 is a dual power MOSFET module designed for fast switching applications of high voltage and current. (2 devices are serial connected.) The mounting base of the module is electrically isolated from semiconductor elements for simple heatsink construction.

- $I_D=75A$, $V_{DS}=500V$
- Suitable for high speed switching applications.
- Low ON resistance.
- Wide Safe Operating Areas.

(Applications)

UPS(CVCF), Motor Control, Switching Power Supply, etc.

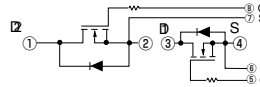
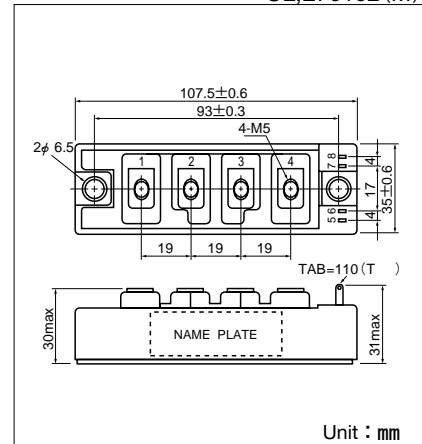

Maximum Ratings

($T_j=25^\circ\text{C}$ u n l)

Symbol	Item		Conditions	Ratings		Unit
				FBA75CA45	FBA75CA50	
V_{DS}	Drain-Source Voltage			450	500	V
V_{GS}	Gate-Source Voltage			± 20		V
I_D	Drain Current	D.C.	Duty=36%	75		A
I_{DP}		Pulse		150		
$-I_D$	Source Current			75		A
P_T	Total Power Dissipation		$T_c=25^\circ\text{C}$	400		W
T_j	Channel Temperature			150		$^\circ\text{C}$
T_{stg}	Storage Temperature			-40 t $+125$		$^\circ\text{C}$
V_{iso}	Isolation Voltage (R.M.S.)		A.C. 1minute	2500		V
	Mounting Torque	Mounting (M6)	Recommended Value 2.5-3.9 (25-40)	4.7 (48)		N·m (kgf·cm)
		Terminal (M5)	Recommended Value 1.5-2.5 (15-25)	2.7 (28)		
	Mass		Typical Value	220		g

Electrical Characteristics

($T_j=25^\circ\text{C}$ u n l)

Symbol	Item		Conditions	Ratings			Unit
				Min.	Typ.	Max.	
I_{GSS}	Gate Leakage Current		$V_{GS}=\pm 20V$, $V_{DS}=0V$			± 1.0	μA
I_{DSS}	Zero Gate Voltage Drain Current		$V_{GS}=0V$, $V_{DS}=500V$			1.0	mA
$V_{(BR)DS}$	Drain-Source Breakdown Voltage	FBA75CA45	$V_{GS}=0V$, $I_D=1mA$	450			V
		FBA75CA50		500			
$V_{GS(th)}$	Gate-Source Threshold Voltage		$V_{DS}=V_{GS}$, $I_D=10mA$	1.0		5.0	V
$R_{DS(on)}$	Drain-Source On-State Resistance		$I_D=40A$, $V_{GS}=15V$			0.10	Ω
$V_{DS(on)}$	Drain-Source On-State Voltage		$I_D=40A$, $V_{GS}=15V$			4.0	V
g_{fs}	Forward Transconductance		$V_{DS}=10V$, $V_D=40A$		40		S
C_{iss}	Input Capacitance		$V_{GS}=0V$, $V_{DS}=25V$, $f=1.0MHz$			13500	pF
C_{oss}	Output Capacitance		$V_{GS}=0V$, $V_{DS}=25V$, $f=1.0MHz$			2500	pF
C_{rss}	Reverse Transfer Capacitance		$V_{GS}=0V$, $V_{DS}=25V$, $f=1.0MHz$			1000	pF
$t_{d(on)}$	Switching Time	Turn-on Delay Time	$R_L=7.5\Omega$, $R_G=50\Omega$, $V_{GS}=15V$ $I_D=40A$, $R_G=5\Omega$		60		ns
t_r		Rise Time			120		
$t_{d(off)}$		Turn-off Delay Time			700		
t_f		Fall Time			210		
V_{SDS}	Diode Forward Voltage		$-I_D=40A$, $V_{GS}=0V$			1.5	V
t_{rr}	Reverse Recovery Time		$-I_D=40A$, $V_{GS}=0V$, $di/dt=100A/\mu s$		700		ns
$R_{th(j-c)}$	Thermal Resistance					0.31	$^\circ\text{C}/W$

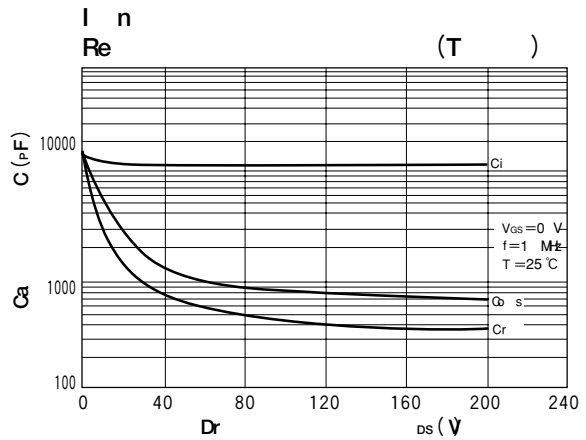
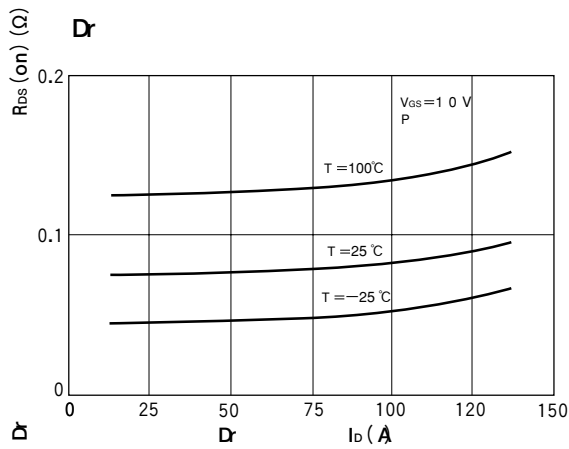
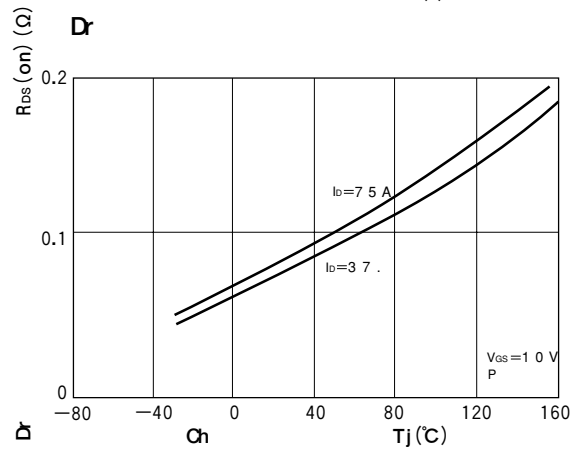
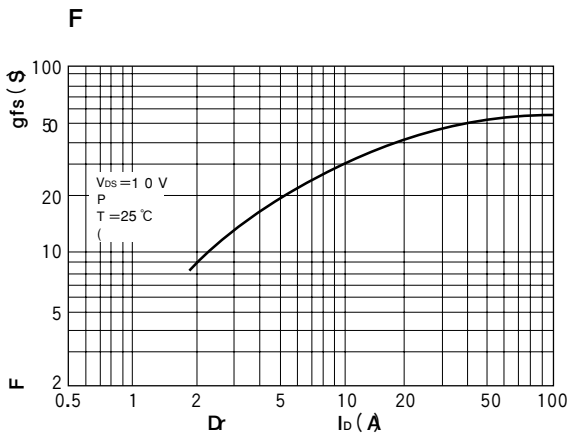
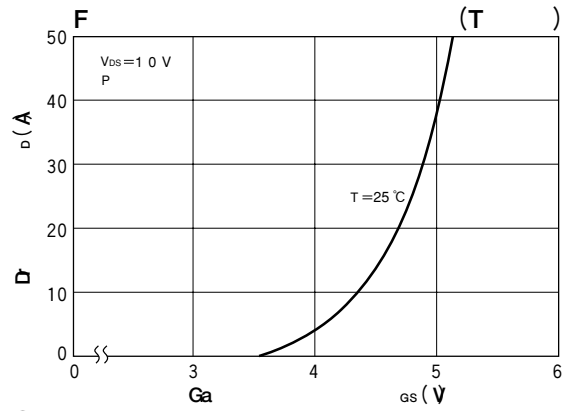
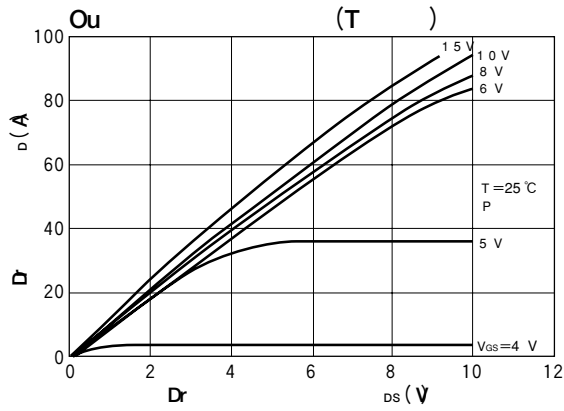

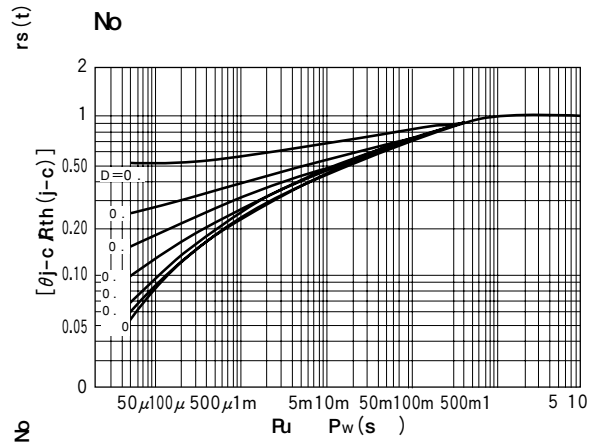
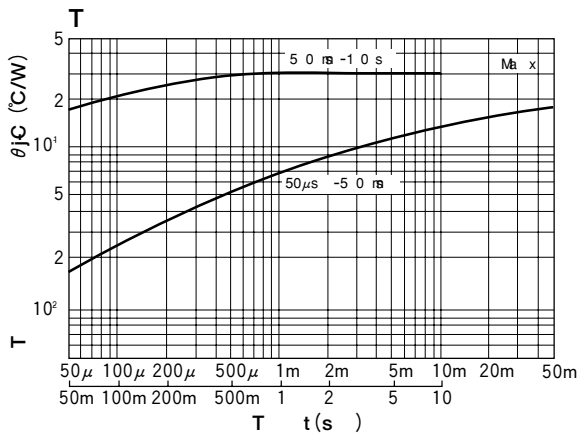
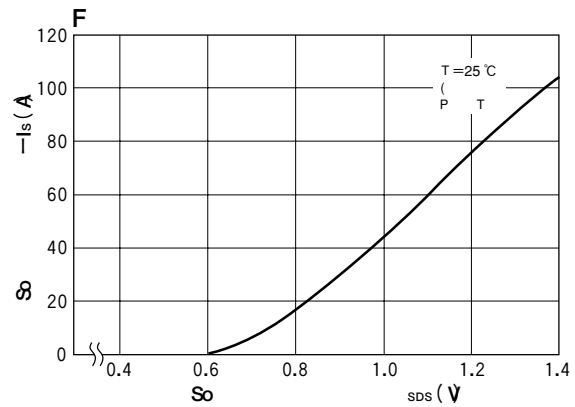
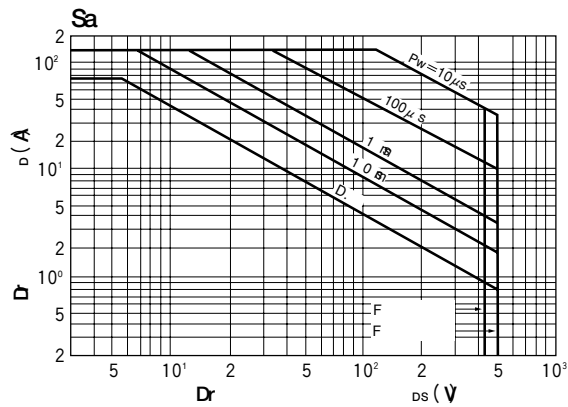

MOSFET MODULE

SF100BA50



UL:E76102(M)

SF100BA50 is a isolated power MOSFET module designed for fast switching applications of high voltage and current. The mounting base of the module is electrically isolated from semiconductor elements for simple heatsink construction.

- $I_D=100A$, $V_{DS}=500V$
- Suitable for high speed switching applications.
- Low ON resistance.
- Wide Safe Operating Areas.
- $t_{rr} \leq 700ns$

(Applications)

UPS (CVCF), Motor Control, Switching Power Supply, etc.

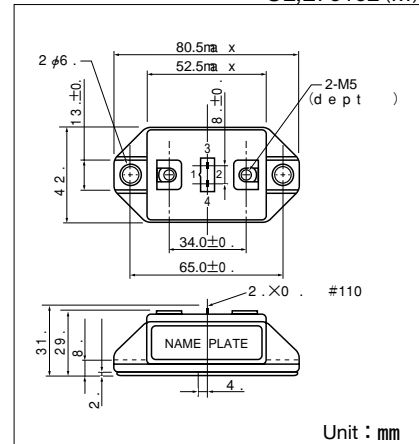
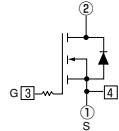

■ **Maximum Ratings**

($T_j=25^\circ C$ u n l)

Symbol	Item		Conditions	Ratings		Unit
				SF100BA50		
V_{DS}	Drain-Source Voltage			500		V
V_{GS}	Gate-Source Voltage			± 20		V
I_D	Drain Current	DC	Duty=43%	100		A
I_{DP}		Pulse		200		
$-I_D$	Source Current			100		A
P_T	Total Power Dissipation		$T_c=25^\circ C$	600		W
T_j	Channel Temperature			$-40 \sim +150$		$^\circ C$
T_{stg}	Storage Temperature			$-40 \sim +125$		$^\circ C$
V_{iso}	Isolation Voltage (R.M.S.)		A.C. 1minute	2500		V
	Mounting Torque	Mounting (M6)	Recommended Value 2.5~3.9 (25~40)	4.7 (48)		N·m (kgf·cm)
		Terminal (M5)	Recommended Value 1.5~2.5 (15~25)	2.7 (28)		
	Mass		Typical Value	160		g

■ **Electrical Characteristics**

($T_j=25^\circ C$ u n l)

Symbol	Item		Conditions	Ratings			Unit
				Min.	Typ.	Max.	
I_{GSS}	Gate Leakage Current		$V_{GS}=\pm 20V$, $V_{DS}=0V$			± 2.0	μA
I_{DSS}	Zero Gate Voltage Drain Current		$V_{GS}=0V$, $V_{DS}=500V$			1.0	mA
$V_{(BR)DS}$	Drain-Source Breakdown Voltage		$V_{GS}=0V$, $I_D=1mA$	500			V
$V_{GS(th)}$	Gate-Source Threshold Voltage		$V_{DS}=V_{GS}$, $I_D=10mA$	1.0		5.0	V
$R_{DS(on)}$	Drain-Source On-State Resistance		$I_D=50A$, $V_{GS}=15V$			70	m Ω
$V_{DS(on)}$	Drain-Source On-State Voltage		$I_D=50A$, $V_{GS}=15V$			3.5	V
g_{fs}	Forward Transconductance		$V_{DS}=10A$, $I_D=50A$		60		S
C_{iss}	Input Capacitance		$V_{GS}=0V$, $V_{DS}=25V$, $f=1.0MHz$			20000	pF
C_{oss}	Output Capacitance		$V_{GS}=0V$, $V_{DS}=25V$, $f=1.0MHz$			3800	pF
C_{rss}	Reverse Transfer Capacitance		$V_{GS}=0V$, $V_{DS}=25V$, $f=1.0MHz$			1500	pF
$t_{d(on)}$	Switching Time	Turn-on Delay Time	$R_L=6\Omega$, $R_G=50\Omega$, $V_{GS}=15V$ $I_D=50A$, $R_G=5\Omega$		70		μs
t_r		Rise Time			120		
$t_{d(off)}$		Turn-off Delay Time			1100		
t_f		Fall Time			280		
V_{SDS}	Diode Forward Voltage		$-I_D=50A$, $V_{GS}=0V$			1.5	V
t_{rr}	Reverse Recovery Time		$-I_D=50A$, $V_{GS}=0V$, $di/dt=100A/\mu s$		700		ns
$R_{th(j-c)}$	Thermal Resistance					0.21	$^\circ C/W$

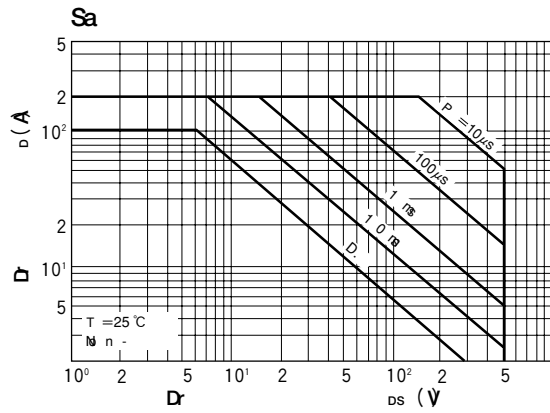
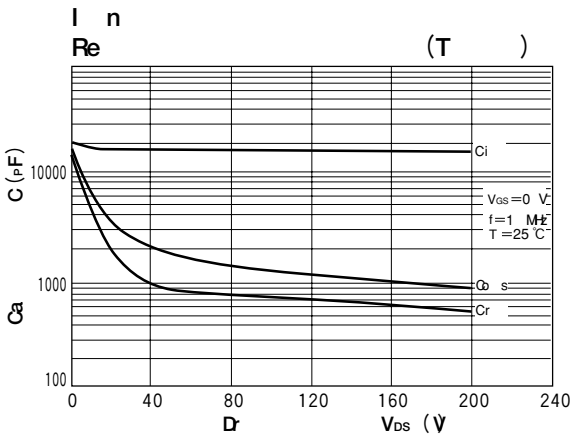
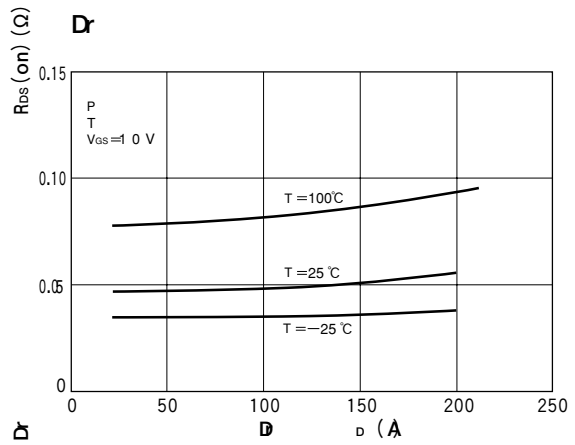
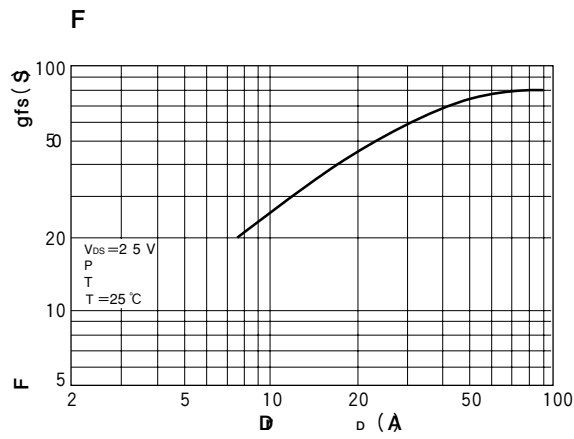
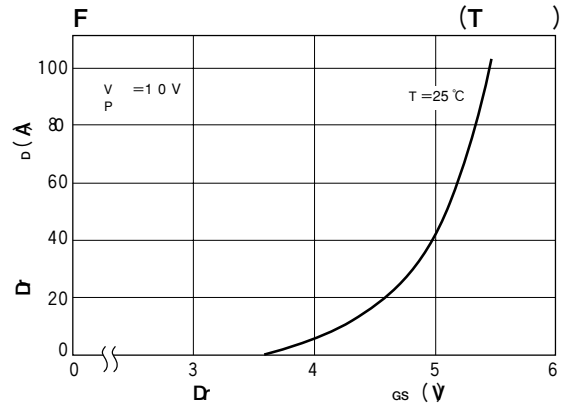
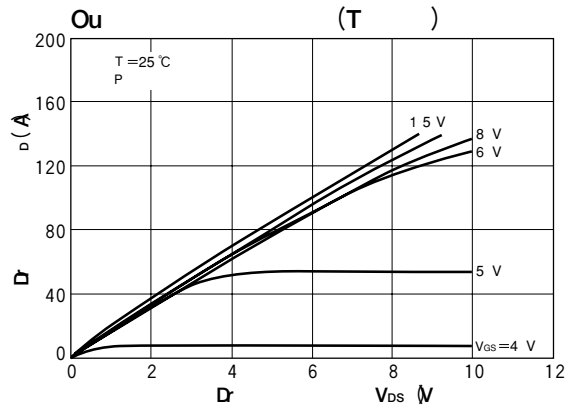

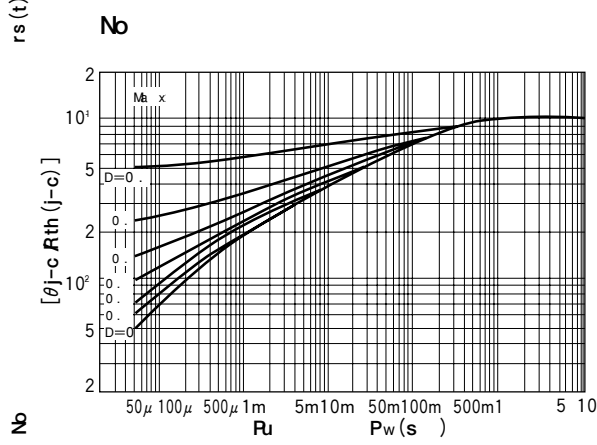
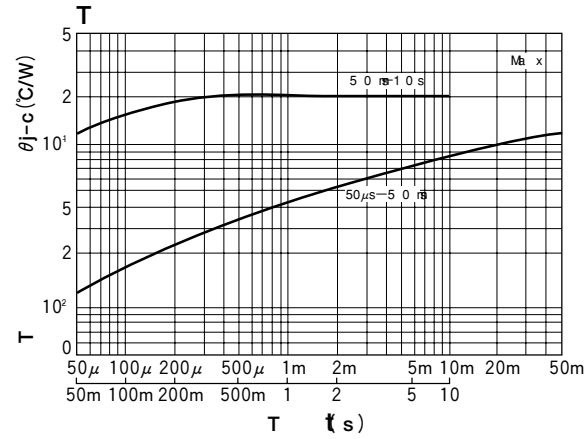
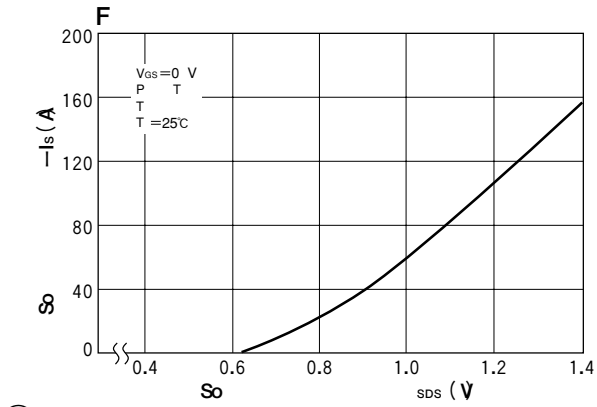

MOSFET MODULE

SF150BA50



UL;E76102(M)

SF150BA50 is a isolated power MOSFET module designed for fast switching applications of high voltage and current. The mounting base of the module is electrically isolated from semiconductor elements for simple heatsink construction.

- $I_D=150A$, $V_{DS}=500V$
- Suitable for high speed switching application.
- Low ON resistance.
- Wide Safe Operating Areas.

(Applications)

UPS(CVCF), Motor Control, Switching Power Supply, etc.

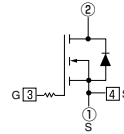
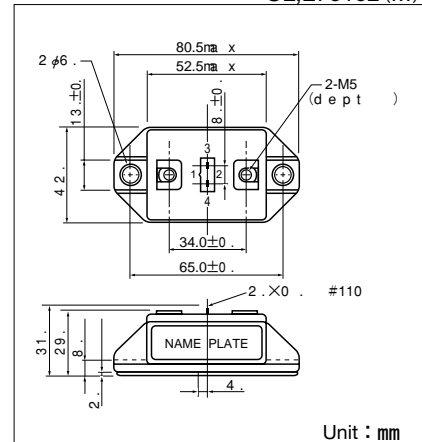

Maximum Ratings

($T_j=25^\circ\text{C}$ u n l)

Symbol	Item		Conditions	Ratings			Unit
				SF150BA50			
V_{DS}	Drain-Source Voltage			500			V
V_{GS}	Gate-Source Voltage			± 20			V
I_D	Drain Current	DC	Duty=35%	150			A
I_{DP}		Pulse		300			
$-I_D$	Source Current			150			A
P_T	Total Power Dissipation		$T_c=25^\circ\text{C}$	780			W
T_j	Channel Temperature			-40 t $+150$			$^\circ\text{C}$
T_{stg}	Storage Temperature			-40 t $+125$			$^\circ\text{C}$
V_{iso}	Isolation Voltage (R.M.S.)		A.C. 1minute	2500			V
	Mounting Torque	Mounting (M6)	Recommended Value 2.5-3.9 (25-40)	4.7 (48)			N·m (kgf·cm)
		Terminal (M5)	Recommended Value 1.5-2.5 (15-25)	2.7 (28)			
	Mass		Typical Value	160			g

Electrical Characteristics

($T_j=25^\circ\text{C}$ u n l)

Symbol	Item		Conditions	Ratings			Unit
				Min.	Typ.	Max.	
I_{GSS}	Gate Leakage Current		$V_{GS}=\pm 20V$, $V_{DS}=0V$			± 2.0	μA
I_{DSS}	Zero Gate Voltage Drain Current		$V_{GS}=0V$, $V_{DS}=500V$			2.0	mA
$V_{(BR)DS}$	Drain-Source Breakdown Voltage		$V_{GS}=0V$, $I_D=1mA$	500			V
$V_{GS(th)}$	Gate-Source Threshold Voltage		$V_{DS}=V_{GS}$, $I_D=10mA$	1.0		5.0	V
$R_{DS(on)}$	Drain-Source On-State Resistance		$I_D=75A$, $V_{GS}=15V$			50	m Ω
$V_{DS(on)}$	Drain-Source On-State Voltage		$I_D=75A$, $V_{GS}=15V$			3.75	V
g_{fs}	Forward Transconductance		$V_{DS}=10V$, $I_D=75A$		80		S
C_{iss}	Input Capacitance		$V_{GS}=0V$, $V_{DS}=25V$, $f=1.0MHz$			27000	pF
C_{oss}	Output Capacitance		$V_{GS}=0V$, $V_{DS}=25V$, $f=1.0MHz$			5000	pF
C_{rss}	Reverse Transfer Capacitance		$V_{GS}=0V$, $V_{DS}=25V$, $f=1.0MHz$			2000	pF
$t_{d(on)}$	Switching Time	Turn-on Delay Time	$R_L=4\Omega$, $R_G=50\Omega$, $V_{GS}=15V$ $I_D=75A$, $R_G=5\Omega$		90		ns
t_r		Rise Time			180		
$t_{d(off)}$		Turn-off Delay Time			1400		
t_f		Fall Time			360		
V_{SDS}	Diode Forward Voltage		$-I_D=75A$, $V_{GS}=0V$			1.5	V
t_{rr}	Reverse Recovery Time		$-I_D=75A$, $V_{GS}=0V$, $di/dt=100A/\mu s$		700		ns
$R_{th(j-c)}$	Thermal Resistance					0.16	$^\circ\text{C}/W$

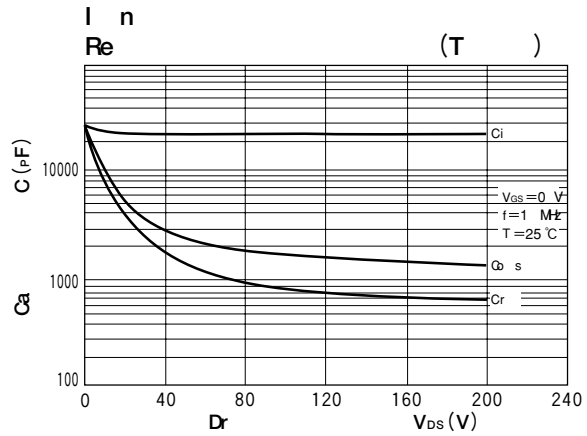
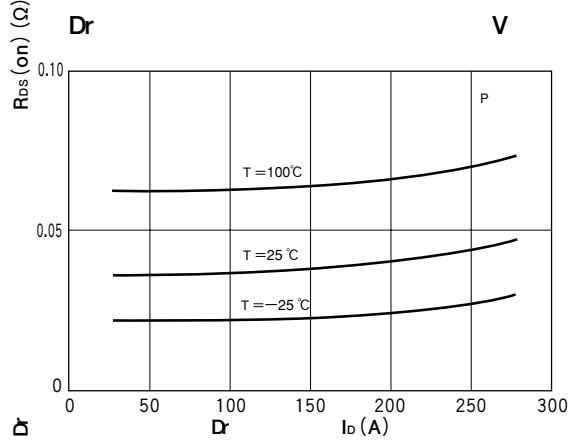
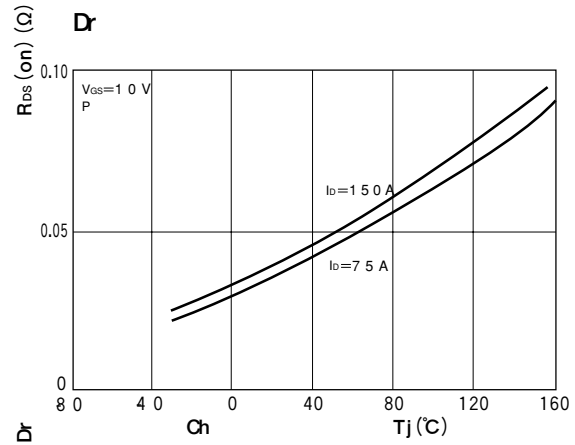
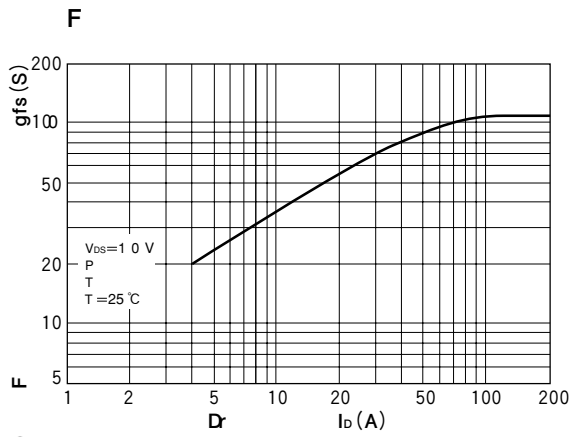
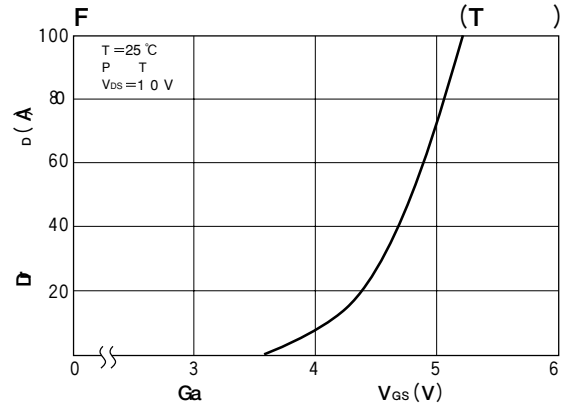
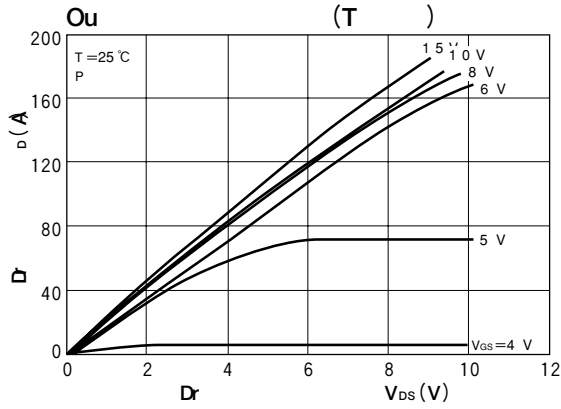

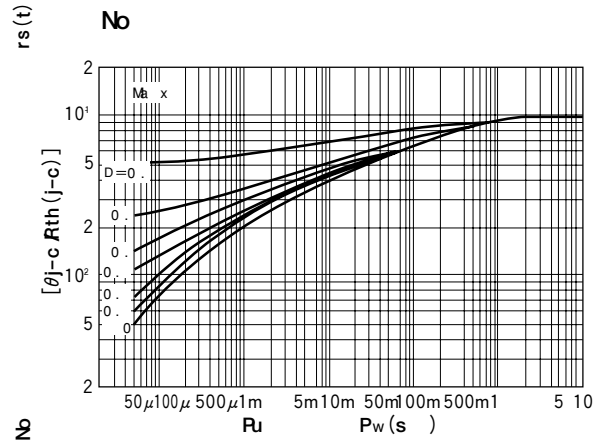
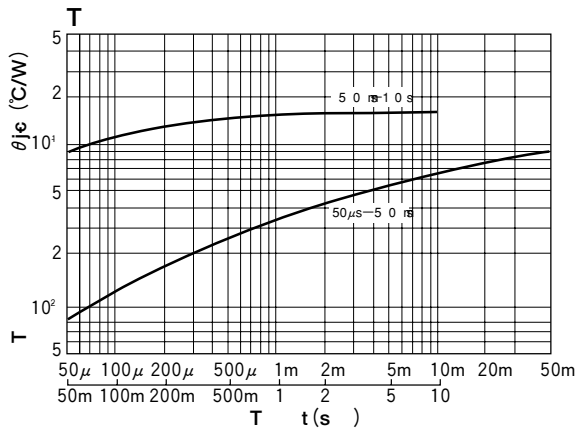
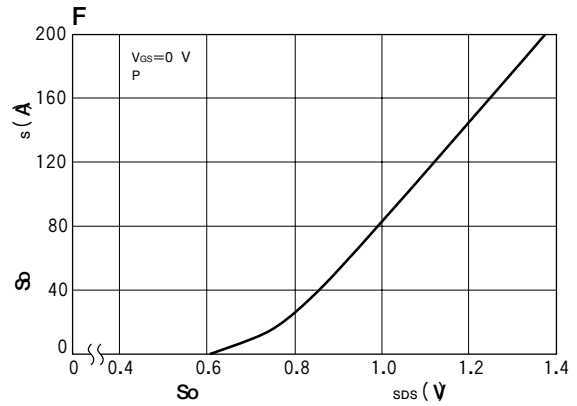
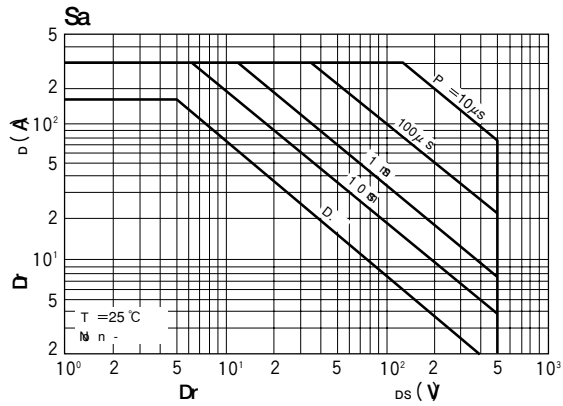

MOSFET MODULE

SF100CB100



UL;E76102(M)

SF100CB100 is a isolated power MOSFET module designed for fast swiching applications of high voltage and current with a fast recovery diode ($t_{rr} \leq 300\text{ns}$) reverse connected. The mounting base of the module is electrically isolated from semiconductor elements for simple heatsink construction.

- $I_D=100\text{A}$, $V_{DSS}=1000\text{V}$
- Suitable for high speed switching applications.
- Low ON resistance.
- Wide Safe Operating Areas.
- $t_{rr} \leq 300\text{ns}$ fast recovery diode for free wheel

(Applications)

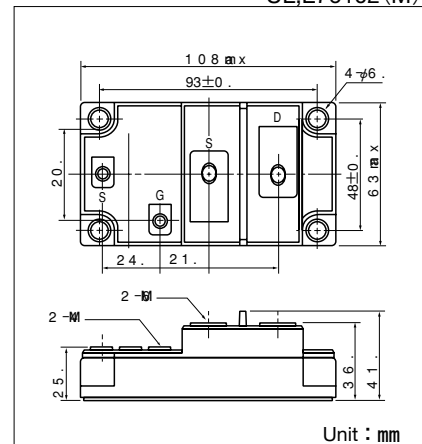
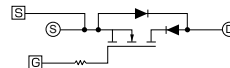

Maximum Ratings

($T_j=25^\circ\text{C}$ u n l)

Symbol	Item		Conditions	Ratings			Unit
				SF100CB100			
V_{DSS}	Drain-Source Voltage			1000			V
V_{GSS}	Gate-Source Voltage			± 30			V
I_D	Drain Current	DC		100			A
I_{DP}		Pulse		200			
$-I_D$	Source Current			100			A
P_T	Total Power Dissipation		$T_c=25^\circ\text{C}$	800			W
T_j	Channel Temperature			-40 t $+150$			$^\circ\text{C}$
T_{stg}	Storage Temperature			-40 t $+125$			$^\circ\text{C}$
V_{iso}	Isolation Voltage (R.M.S.)		A.C. 1minute	2500			V
	Mounting Torque	Mounting (M6)	Recommended Value 2.5-3.9 (25-40)	4.7 (48)			N·m (kgf·cm)
		Terminal (M6)	Recommended Value 2.5-3.9 (25-40)	4.7 (48)			
		Terminal (M4)	Recommended Value 1.0-1.4 (10-14)	1.5 (15)			
	Mass		Typical Value	460			g

Electrical Characteristics

($T_j=25^\circ\text{C}$ u n l)

Symbol	Item		Conditions	Ratings			Unit
				Min.	Typ.	Max.	
I_{GSS}	Gate Leakage Current		$V_{GS}=\pm 20\text{V}$, $V_{DS}=0\text{V}$			± 0.1	μA
I_{DSS}	Zero Gate Voltage Drain Current		$V_{GS}=0\text{V}$, $V_{DS}=800\text{V}$			4.0	mA
$V_{(BR)DSS}$	Darin-Source Breakdown Voltage		$V_{GS}=0\text{V}$, $I_D=1\text{mA}$	1000			V
$V_{GS(th)}$	Gate-Source Threshold Voltage		$V_{DS}=V_{GS}$, $I_D=10\text{mA}$	1.5			V
$R_{DS(on)}$	Drain-Source On-State Resistance		$I_D=100\text{A}$, $V_{GS}=15\text{V}$			150	m Ω
$V_{DS(on)}$	Drain-Source On-State Voltage		$I_D=100\text{A}$, $V_{GS}=15\text{V}$			15	V
g_{fs}	Forward Transconductance		$V_{DS}=10\text{A}$, $V_D=75\text{A}$	30	50		S
C_{iss}	Input Capacitance		$V_{GS}=0\text{V}$, $V_{DS}=25\text{V}$, $f=1.0\text{MHz}$	16000	19200		pF
C_{oss}	Output Capacitance		$V_{GS}=0\text{V}$, $V_{DS}=25\text{V}$, $f=1.0\text{MHz}$	2900	4200		pF
C_{rss}	Reverse Transfer Capacitance		$V_{GS}=0\text{V}$, $V_{DS}=25\text{V}$, $f=1.0\text{MHz}$	1800	2600		pF
$t_{d(on)}$	Switching Time	Turn-on Delay Time	$R_L=6\Omega$, $V_{GS}=15\text{V}/-5\text{V}$ $I_D=100\text{A}$, $R_G=2.2\Omega$			150	ns
t_r		Rise Time				300	
$t_{d(off)}$		Turn-off Delay Time				600	
t_f		Fall Time				300	
V_{SDS}	Diode Forward Voltage		$-I_D=100\text{A}$, $V_{GS}=0\text{V}$			1.8	V
t_{rr}	Reverse Recovery Time		$-I_D=100\text{A}$, $V_{GS}=15\text{V}$, $di/dt=400\text{A}/\mu\text{s}$			300	ns
$R_{th(j-c)}$	Thermal Resistance		MOSFET			0.16	$^\circ\text{C}/\text{W}$
			Diode			0.64	

