

# 2MBI75N-120

IGBT Module

1200V / 75A 2 in one-package

## ■ Features

- High speed switching
- Voltage drive
- Low inductance module structure

## ■ Applications

- Inverter for Motor drive
- AC and DC Servo drive amplifier
- Uninterruptible power supply
- Industrial machines, such as Welding machines



## ■ Maximum ratings and characteristics

● Absolute maximum ratings (at  $T_c=25^\circ\text{C}$  unless otherwise specified)

Item	Symbol	Rating	Unit
Collector-Emitter voltage	$V_{CES}$	1200	V
Gate-Emitter voltage	$V_{GES}$	$\pm 20$	V
Collector current	Continuous	$I_c$	75 A
	1ms	$I_c$ pulse	150 A
	Continuous	$-I_c$	75 A
	1ms	$-I_c$ pulse	150 A
Max. power dissipation	$P_c$	600	W
Operating temperature	$T_j$	+150	$^\circ\text{C}$
Storage temperature	$T_{stg}$	-40 to +125	$^\circ\text{C}$
Isolation voltage	$V_{is}$	AC 2500 (1min.)	V
Screw torque	Mounting *1	3.5	N·m
	Terminals *1	3.5	N·m

\*1: Recommendable value : 2.5 to 3.5 N·m(M5)

## ■ Equivalent Circuit Schematic

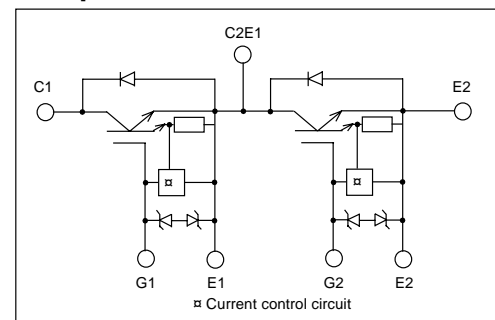

● Electrical characteristics (at  $T_j=25^\circ\text{C}$  unless otherwise specified)

Item	Symbol	Characteristics			Conditions	Unit
		Min.	Typ.	Max.		
Zero gate voltage collector current	$I_{CES}$	-	-	1.0	$V_{GE}=0V, V_{CE}=1200V$	mA
Gate-Emitter leakage current	$I_{GES}$	-	-	15	$V_{CE}=0V, V_{GE}=\pm 20V$	$\mu\text{A}$
Gate-Emitter threshold voltage	$V_{GE(th)}$	4.5	-	7.5	$V_{CE}=20V, I_c=75\text{mA}$	V
Collector-Emitter saturation voltage	$V_{CE(sat)}$	-	-	3.3	$V_{GE}=15V, I_c=75A$	V
Input capacitance	$C_{ies}$	-	12000	-	$V_{GE}=0V$	pF
Output capacitance	$C_{oes}$	-	4350	-	$V_{CE}=10V$	
Reverse transfer capacitance	$C_{res}$	-	3870	-	$f=1\text{MHz}$	
Turn-on time	$t_{on}$	-	0.65	1.2	$V_{CC}=600V$	$\mu\text{s}$
	$t_r$	-	0.25	0.6	$I_c=75A$	
Turn-off time	$t_{off}$	-	0.85	1.5	$V_{GE}=\pm 15V$	$\mu\text{s}$
	$t_f$	-	0.35	0.5	$R_G=16\text{ohm}$	
Diode forward on voltage	$V_F$	-	-	3.0	$I_F=75A, V_{GE}=0V$	V
Reverse recovery time	$t_{rr}$	-	-	0.35	$I_F=75A$	$\mu\text{s}$

● Thermal resistance characteristics

Item	Symbol	Characteristics			Conditions	Unit
		Min.	Typ.	Max.		
Thermal resistance	$R_{th(j-c)}$	-	-	0.21	IGBT	$^\circ\text{C/W}$
	$R_{th(j-c)}$	-	-	0.47	Diode	$^\circ\text{C/W}$
	$R_{th(c-f)}^*2$	-	0.05	-	the base to cooling fin	$^\circ\text{C/W}$

\*2: This is the value which is defined mounting on the additional cooling fin with thermal compound

■ Characteristics (Representative)

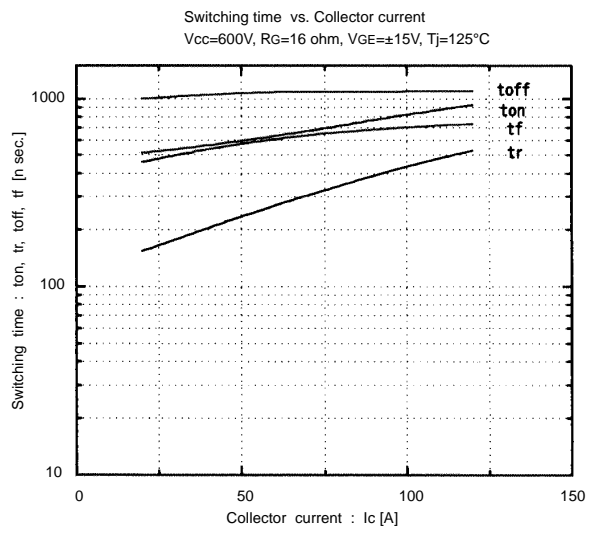
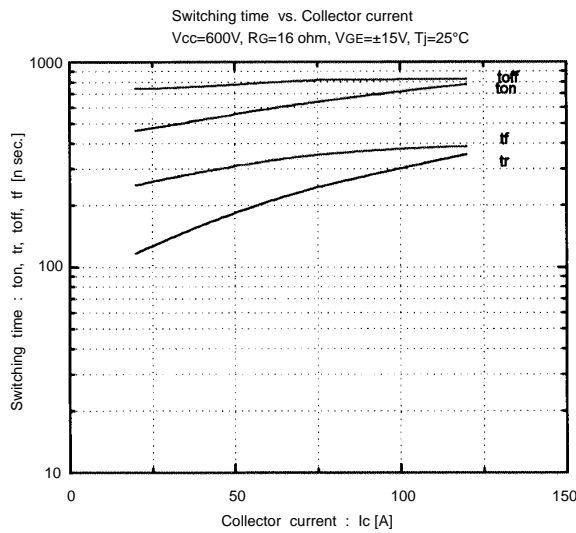
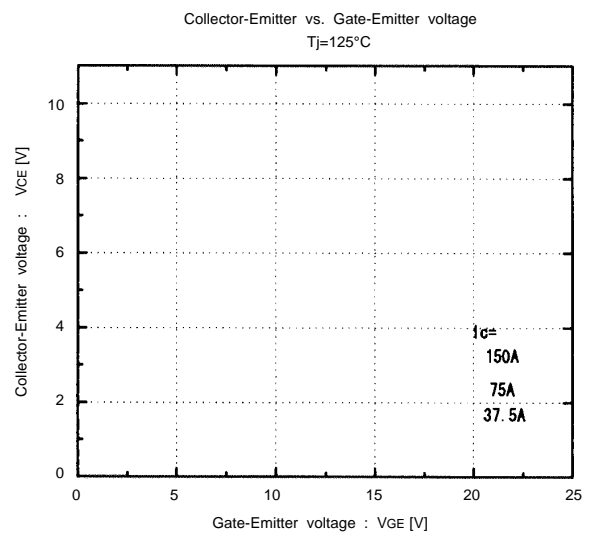
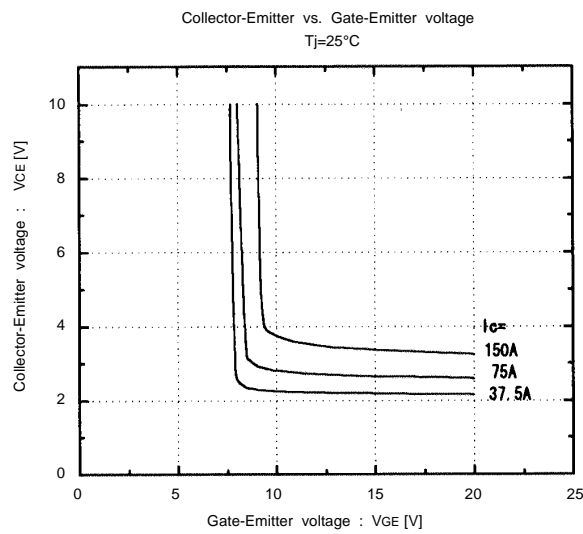
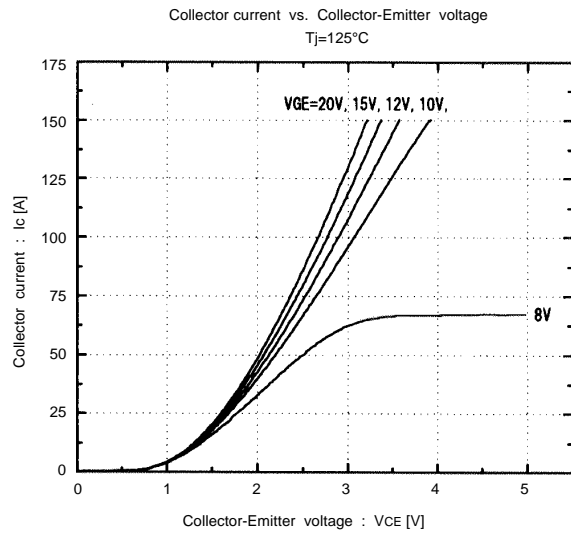
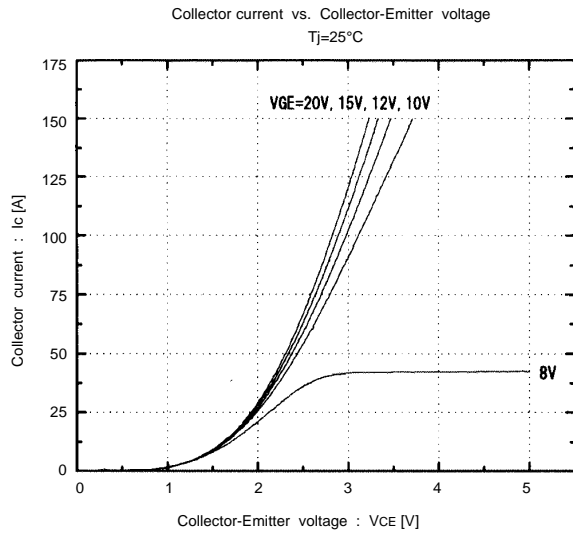

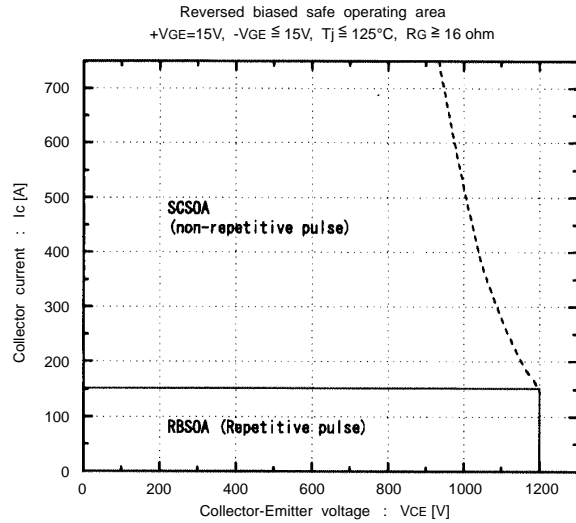
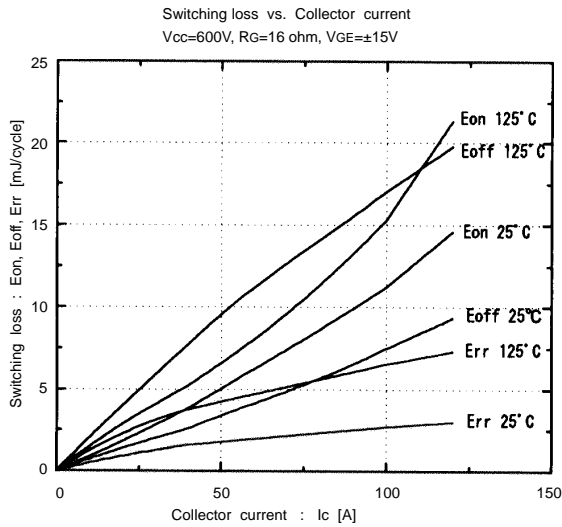
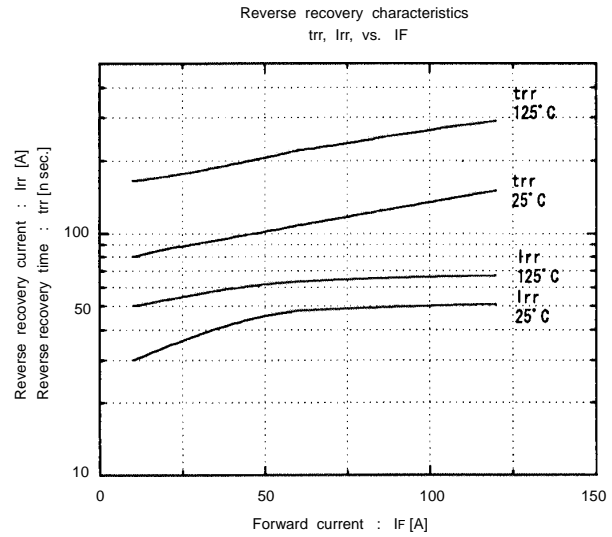
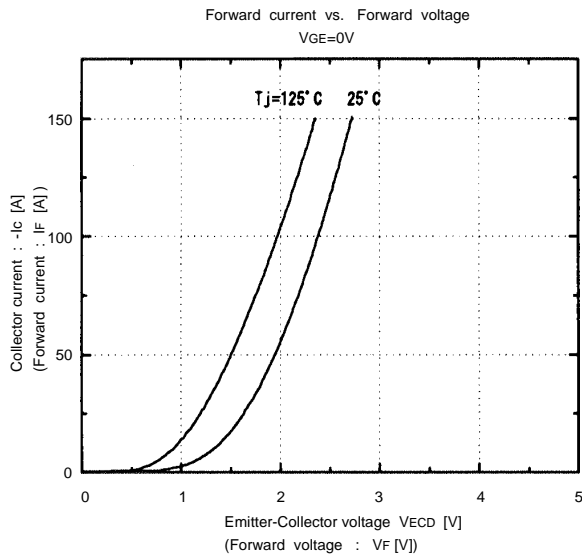
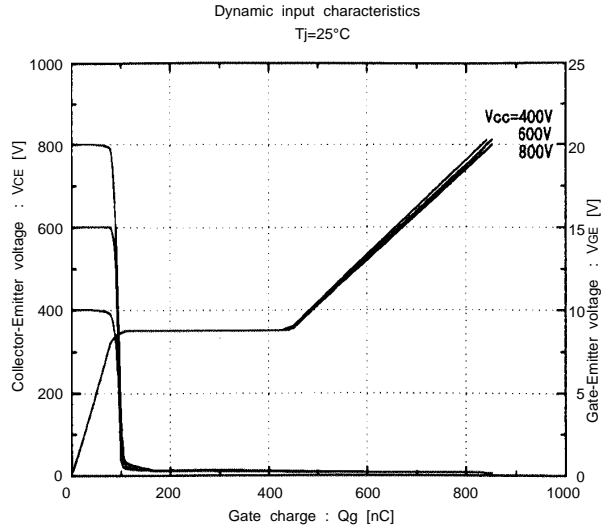
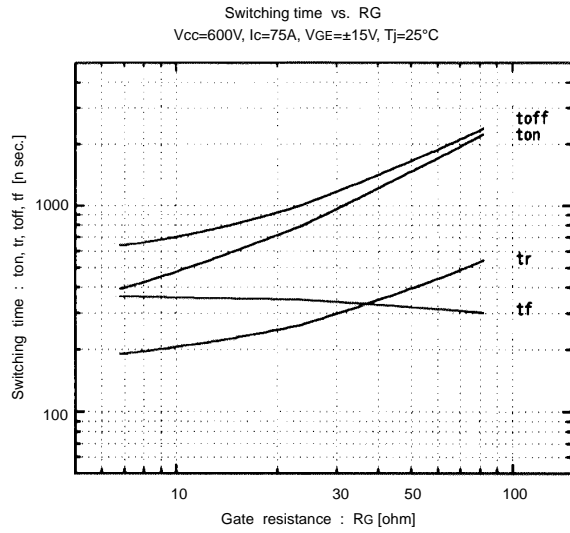

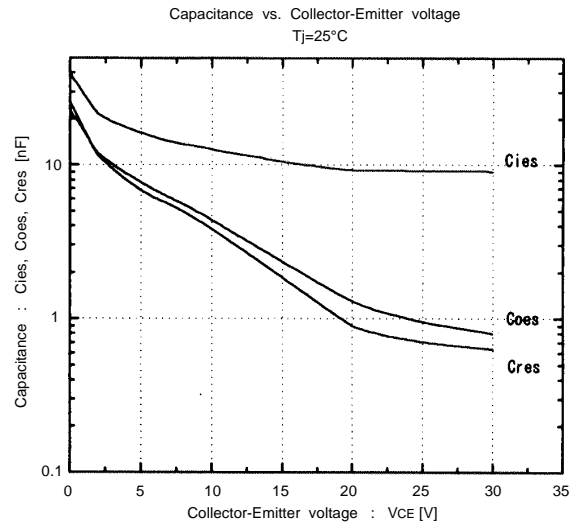
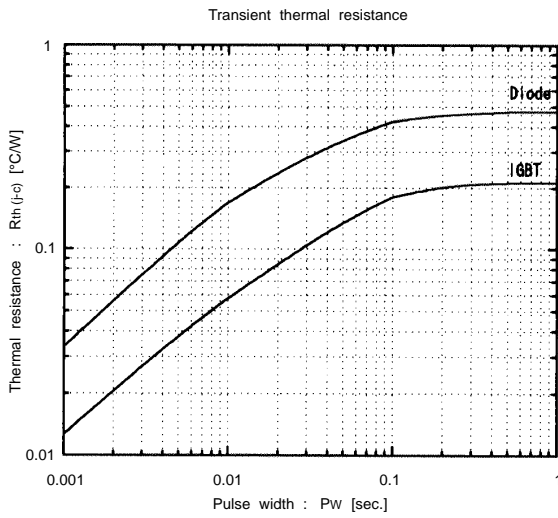

■ Outline Drawings, mm

