



# SANYO Semiconductors DATA SHEET

## L780S00 Series — Monolithic Linear IC 5 to 24V 1A 5-Pin Voltage Regulators with Strobe Pin

### Features

- Output voltage  
L780S05 : 5V      L780S08 : 8V      L780S09 : 9V  
L780S10 : 10V    L780S12 : 12V    L780S15 : 15V  
L780S18 : 18V
- The strobe pin can be used to turn ON / OFF output voltage (active-low).
- 1A output current.
- On-chip thermal protector.
- On-chip overcurrent limiter.
- On-chip ASO protector.
- The use of package TO-220-5H (5 pins) facilitates mounting and thermal design.

### Specifications

[Common to L780S00 series]

Maximum Ratings at Ta=25°C

Parameter	Symbol	Conditions	Ratings	Unit
Maximum supply voltage	V <sub>CC</sub> max	Pin 1	35	V
Strobe input voltage	V <sub>ST</sub> max	Pin 4	18	V
Strobe input current	I <sub>ST</sub> max	Pin 4	5	mA
Allowable power dissipation	Pd max		1.75	W
		T <sub>c</sub> =25°C	20	W
Thermal resistance	θ <sub>j-c</sub>		5	°C / W
Operating temperature	T <sub>opr</sub>		-20 to +80	°C
Storage temperature	T <sub>stg</sub>		-55 to +150	°C

Strobe Operating Characteristics at Ta=25°C

Parameter	Symbol	Conditions	Ratings	Unit
Strobe operation start voltage	V <sub>st(on)</sub>		2.4	V
Strobe operation stop voltage	V <sub>st(off)</sub>		0.5	V

■ Any and all SANYO Semiconductor products described or contained herein do not have specifications that can handle applications that require extremely high levels of reliability, such as life-support systems, aircraft's control systems, or other applications whose failure can be reasonably expected to result in serious physical and/or material damage. Consult with your SANYO Semiconductor representative nearest you before using any SANYO Semiconductor products described or contained herein in such applications.

■ SANYO Semiconductor assumes no responsibility for equipment failures that result from using products at values that exceed, even momentarily, rated values (such as maximum ratings, operating condition ranges, or other parameters) listed in products specifications of any and all SANYO Semiconductor products described or contained herein.

**SANYO Semiconductor Co., Ltd.**

TOKYO OFFICE Tokyo Bldg., 1-10, 1 Chome, Ueno, Taito-ku, TOKYO, 110-8534 JAPAN

82306 / 63006 SY IM / 21006 SY IM / 11200TH (KT) / 8119YK / N307TA / 9047KI / 7086KI / 4045MW, TS No.1700-1/8

## L780S00 Series

[L780S05]

### Recommended Operating Conditions at $T_a=25^\circ\text{C}$

Parameter	Symbol	Conditions	Ratings	Unit
Input voltage range	$V_{IN}$		7.5 to 20.0	V
Output current range	$I_O$		5 to 1000	mA

### Operating Characteristics at $T_j=25^\circ\text{C}$ , $V_{IN}=10\text{V}$ , $I_O=500\text{mA}$ , $V_{st}=0\text{V}$ , $*T_a=25^\circ\text{C}$

Parameter	Symbol	Conditions	Ratings			Unit
			min	typ	max	
Output voltage	$V_{O1}$		4.8	5.0	5.2	V
	$V_{O2}$	$7\text{V} \leq V_{IN} \leq 20\text{V}$ , $5\text{mA} \leq I_O \leq 1\text{A}$	4.75		5.25	V
Line regulation 1	$\Delta V_{OLN1}$	$7\text{V} \leq V_{IN} \leq 25\text{V}$		3	100	mV
Line regulation 2	$\Delta V_{OLN2}$	$8\text{V} \leq V_{IN} \leq 12\text{V}$		1	50	mV
Load regulation 1	$\Delta V_{OLD1}$	$5\text{mA} \leq I_O \leq 1.5\text{A}$			100	mV
Load regulation 2	$\Delta V_{OLD2}$	$250\text{mA} \leq I_O \leq 750\text{mA}$			50	mV
Current dissipation	$I_{CC}$				8.0	mA
Current dissipation variation (Line)	$\Delta I_{CCLN}$	$7\text{V} \leq V_{IN} \leq 25\text{V}$			1.3	mA
Current dissipation variation (Load)	$\Delta I_{CCLD}$	$5\text{mA} \leq I_O \leq 1\text{A}$			0.5	mA
Output noise voltage	$V_{NO}$	$10\text{Hz} \leq f \leq 100\text{kHz}^*$		40		$\mu\text{V}$
Ripple rejection	$R_r$	$f=120\text{Hz}$ , $8\text{V} \leq V_{IN} \leq 18\text{V}$	62	78		dB
Dropout voltage	$V_{drop}$	$I_O=1\text{A}$		2.0		V
Output short current	$I_{OS}$	$V_{IN}=35\text{V}$		0.75		A
Peak output current	$I_{OP}$			2.2		A
Output voltage at strobe mode	$V_{O(ston)}$	$V_{IN}=35\text{V}$ , $V_{st}=5\text{V}$ , $I_O=0\text{A}$ , *			0.8	V
Current dissipation at strobe mode	$I_{CC(ston)}$	$V_{IN}=35\text{V}$ , $V_{st}=5\text{V}$ , $I_O=0\text{A}$ , *			3.0	mA
Strobe input current	$I_{st}$	$V_{IN}=35\text{V}$ , $V_{st}=5\text{V}$ , $I_O=0\text{A}$ , *			1.0	mA

[L780S08]

### Recommended Operating Conditions at $T_a=25^\circ\text{C}$

Parameter	Symbol	Conditions	Ratings	Unit
Input voltage range	$V_{IN}$		10.5 to 23.0	V
Output current range	$I_O$		5 to 1000	mA

### Operating Characteristics at $T_j=25^\circ\text{C}$ , $V_{IN}=15\text{V}$ , $I_O=500\text{mA}$ , $V_{st}=0\text{V}$ , $*T_a=25^\circ\text{C}$

Parameter	Symbol	Conditions	Ratings			Unit
			min	typ	max	
Output voltage	$V_{O1}$		7.7	8.0	8.3	V
	$V_{O2}$	$10.5\text{V} \leq V_{IN} \leq 23\text{V}$ , $5\text{mA} \leq I_O \leq 1\text{A}$	7.6		8.4	V
Line regulation 1	$\Delta V_{OLN1}$	$10.5\text{V} \leq V_{IN} \leq 25\text{V}$		6.0	160	mV
Line regulation 2	$\Delta V_{OLN2}$	$11\text{V} \leq V_{IN} \leq 17\text{V}$		2.0	80	mV
Load regulation 1	$\Delta V_{OLD1}$	$5\text{mA} \leq I_O \leq 1.5\text{A}$			160	mV
Load regulation 2	$\Delta V_{OLD2}$	$250\text{mA} \leq I_O \leq 750\text{mA}$			80	mV
Current dissipation	$I_{CC}$				8.0	mA
Current dissipation variation (Line)	$\Delta I_{CCLN}$	$10.5\text{V} \leq V_{IN} \leq 25\text{V}$			1.0	mA
Current dissipation variation (Load)	$\Delta I_{CCLD}$	$5\text{mA} \leq I_O \leq 1\text{A}$			0.5	mA
Output noise voltage	$V_{NO}$	$10\text{Hz} \leq f \leq 100\text{kHz}^*$		52		$\mu\text{V}$
Ripple rejection	$R_r$	$f=120\text{Hz}$ , $11.5\text{V} \leq V_{IN} \leq 21.5\text{V}$	56	72		dB
Dropout voltage	$V_{drop}$	$I_O=1\text{A}$		2.0		V
Output short current	$I_{OS}$	$V_{IN}=35\text{V}$		0.75		A
Peak output current	$I_{OP}$			2.2		A
Output voltage at strobe mode	$V_{O(ston)}$	$V_{IN}=35\text{V}$ , $V_{st}=5\text{V}$ , $I_O=0\text{A}$ , *			0.8	V
Current dissipation at strobe mode	$I_{CC(ston)}$	$V_{IN}=35\text{V}$ , $V_{st}=5\text{V}$ , $I_O=0\text{A}$ , *			3.0	mA
Strobe input current	$I_{st}$	$V_{IN}=35\text{V}$ , $V_{st}=5\text{V}$ , $I_O=0\text{A}$ , *			1.0	mA

## L780S00 Series

[L780S09]

### Recommended Operating Conditions at $T_a=25^\circ\text{C}$

Parameter	Symbol	Conditions	Ratings	Unit
Input voltage range	$V_{IN}$		11.5 to 25.0	V
Output current range	$I_O$		5 to 1000	mA

### Operating Characteristics at $T_j=25^\circ\text{C}$ , $V_{IN}=16\text{V}$ , $I_O=500\text{mA}$ , $V_{st}=0\text{V}$ , $*T_a=25^\circ\text{C}$

Parameter	Symbol	Conditions	Ratings			Unit
			min	typ	max	
Output voltage	$V_{O1}$		8.64	9.0	9.36	V
	$V_{O2}$	$11.5\text{V} \leq V_{IN} \leq 24\text{V}$ , $5\text{mA} \leq I_O \leq 1\text{A}$	8.55		9.45	V
Line regulation 1	$\Delta V_{OLN1}$	$11.5\text{V} \leq V_{IN} \leq 25\text{V}$		7	180	mV
Line regulation 2	$\Delta V_{OLN2}$	$12\text{V} \leq V_{IN} \leq 20\text{V}$		2	90	mV
Load regulation 1	$\Delta V_{OLD1}$	$5\text{mA} \leq I_O \leq 1.5\text{A}$			180	mV
Load regulation 2	$\Delta V_{OLD2}$	$250\text{mA} \leq I_O \leq 750\text{mA}$			90	mV
Current dissipation	$I_{CC}$				8.0	mA
Current dissipation variation (Line)	$\Delta I_{CCLN}$	$11.5\text{V} \leq V_{IN} \leq 26\text{V}$			1.0	mA
Current dissipation variation (Load)	$\Delta I_{CCLD}$	$5\text{mA} \leq I_O \leq 1\text{A}$			0.5	mA
Output noise voltage	$V_{NO}$	$10\text{Hz} \leq f \leq 100\text{kHz}^*$		57		$\mu\text{V}$
Ripple rejection	$R_r$	$f=120\text{Hz}$ , $12\text{V} \leq V_{IN} \leq 22\text{V}$	56	72		dB
Dropout voltage	$V_{drop}$	$I_O=1\text{A}$		2.0		V
Output short current	$I_{OS}$	$V_{IN}=35\text{V}$		0.75		A
Peak output current	$I_{OP}$			2.2		A
Output voltage at strobe mode	$V_{O(ston)}$	$V_{IN}=35\text{V}$ , $V_{st}=5\text{V}$ , $I_O=0\text{A}$ , *			0.8	V
Current dissipation at strobe mode	$I_{CC(ston)}$	$V_{IN}=35\text{V}$ , $V_{st}=5\text{V}$ , $I_O=0\text{A}$ , *			3.0	mA
Strobe input current	$I_{st}$	$V_{IN}=35\text{V}$ , $V_{st}=5\text{V}$ , $I_O=0\text{A}$ , *			1.0	mA

[L780S10]

### Recommended Operating Conditions at $T_a=25^\circ\text{C}$

Parameter	Symbol	Conditions	Ratings	Unit
Input voltage range	$V_{IN}$		13.0 to 25.0	V
Output current range	$I_O$		5 to 1000	mA

### Operating Characteristics at $T_j=25^\circ\text{C}$ , $V_{IN}=17\text{V}$ , $I_O=500\text{mA}$ , $V_{st}=0\text{V}$ , $*T_a=25^\circ\text{C}$

Parameter	Symbol	Conditions	Ratings			Unit
			min	typ	max	
Output voltage	$V_{O1}$		9.6	10.0	10.4	V
	$V_{O2}$	$12.5\text{V} \leq V_{IN} \leq 25\text{V}$ , $5\text{mA} \leq I_O \leq 1\text{A}$	9.5		10.5	V
Line regulation 1	$\Delta V_{OLN1}$	$12.5\text{V} \leq V_{IN} \leq 28\text{V}$		8	200	mV
Line regulation 2	$\Delta V_{OLN2}$	$14\text{V} \leq V_{IN} \leq 20\text{V}$		2.5	100	mV
Load regulation 1	$\Delta V_{OLD1}$	$5\text{mA} \leq I_O \leq 1.5\text{A}$			200	mV
Load regulation 2	$\Delta V_{OLD2}$	$250\text{mA} \leq I_O \leq 750\text{mA}$			100	mV
Current dissipation	$I_{CC}$				8.0	mA
Current dissipation variation (Line)	$\Delta I_{CCLN}$	$12.5\text{V} \leq V_{IN} \leq 25\text{V}$			1.0	mA
Current dissipation variation (Load)	$\Delta I_{CCLD}$	$5\text{mA} \leq I_O \leq 1\text{A}$			0.5	mA
Output noise voltage	$V_{NO}$	$10\text{Hz} \leq f \leq 100\text{kHz}^*$		63		$\mu\text{V}$
Ripple rejection	$R_r$	$f=120\text{Hz}$ , $13\text{V} \leq V_{IN} \leq 23\text{V}$	55	72		dB
Dropout voltage	$V_{drop}$	$I_O=1\text{A}$		2.0		V
Output short current	$I_{OS}$	$V_{IN}=35\text{V}$		0.75		A
Peak output current	$I_{OP}$			2.2		A
Output voltage at strobe mode	$V_{O(ston)}$	$V_{IN}=35\text{V}$ , $V_{st}=5\text{V}$ , $I_O=0\text{A}$ , *			0.8	V
Current dissipation at strobe mode	$I_{CC(ston)}$	$V_{IN}=35\text{V}$ , $V_{st}=5\text{V}$ , $I_O=0\text{A}$ , *			3.0	mA
Strobe input current	$I_{st}$	$V_{IN}=35\text{V}$ , $V_{st}=5\text{V}$ , $I_O=0\text{A}$ , *			1.0	mA

## L780S00 Series

[L780S12]

### Recommended Operating Conditions at $T_a=25^\circ\text{C}$

Parameter	Symbol	Conditions	Ratings	Unit
Input voltage range	$V_{IN}$		15.0 to 27.0	V
Output current range	$I_O$		5 to 1000	mA

### Operating Characteristics at $T_j=25^\circ\text{C}$ , $V_{IN}=19\text{V}$ , $I_O=500\text{mA}$ , $V_{st}=0\text{V}$ , $*T_a=25^\circ\text{C}$

Parameter	Symbol	Conditions	Ratings			Unit
			min	typ	max	
Output voltage	$V_{O1}$		11.5	12.0	12.5	V
	$V_{O2}$	$14.5\text{V} \leq V_{IN} \leq 27\text{V}$ , $5\text{mA} \leq I_O \leq 1\text{A}$	11.4		12.6	V
Line regulation 1	$\Delta V_{OLN1}$	$14.5\text{V} \leq V_{IN} \leq 30\text{V}$		10	240	mV
Line regulation 2	$\Delta V_{OLN2}$	$16\text{V} \leq V_{IN} \leq 22\text{V}$		3	120	mV
Load regulation 1	$\Delta V_{OLD1}$	$5\text{mA} \leq I_O \leq 1.5\text{A}$			240	mV
Load regulation 2	$\Delta V_{OLD2}$	$250\text{mA} \leq I_O \leq 750\text{mA}$			120	mV
Current dissipation	$I_{CC}$				8.0	mA
Current dissipation variation (Line)	$\Delta I_{CCLN}$	$14.5\text{V} \leq V_{IN} \leq 30\text{V}$			1.0	mA
Current dissipation variation (Load)	$\Delta I_{CCLD}$	$5\text{mA} \leq I_O \leq 1\text{A}$			0.5	mA
Output noise voltage	$V_{NO}$	$10\text{Hz} \leq f \leq 100\text{kHz}^*$		75		$\mu\text{V}$
Ripple rejection	$R_r$	$f=120\text{Hz}$ , $15\text{V} \leq V_{IN} \leq 25\text{V}$	55	71		dB
Dropout voltage	$V_{drop}$	$I_O=1\text{A}$		2.0		V
Output short current	$I_{OS}$	$V_{IN}=35\text{V}$		0.75		A
Peak output current	$I_{OP}$			2.2		A
Output voltage at strobe mode	$V_{O(ston)}$	$V_{IN}=35\text{V}$ , $V_{st}=5\text{V}$ , $I_O=0\text{A}$ , *			0.8	V
Current dissipation at strobe mode	$I_{CC(ston)}$	$V_{IN}=35\text{V}$ , $V_{st}=5\text{V}$ , $I_O=0\text{A}$ , *			3.0	mA
Strobe input current	$I_{st}$	$V_{IN}=35\text{V}$ , $V_{st}=5\text{V}$ , $I_O=0\text{A}$ , *			1.0	mA

[L780S15]

### Recommended Operating Conditions at $T_a=25^\circ\text{C}$

Parameter	Symbol	Conditions	Ratings	Unit
Input voltage range	$V_{IN}$		18.0 to 30.0	V
Output current range	$I_O$		5 to 1000	mA

### Operating Characteristics at $T_j=25^\circ\text{C}$ , $V_{IN}=23\text{V}$ , $I_O=500\text{mA}$ , $V_{st}=0\text{V}$ , $*T_a=25^\circ\text{C}$

Parameter	Symbol	Conditions	Ratings			Unit
			min	typ	max	
Output voltage	$V_{O1}$		14.4	15.0	15.6	V
	$V_{O2}$	$17.5\text{V} \leq V_{IN} \leq 30\text{V}$ , $5\text{mA} \leq I_O \leq 1\text{A}$	14.25		15.75	V
Line regulation 1	$\Delta V_{OLN1}$	$17.5\text{V} \leq V_{IN} \leq 30\text{V}$		11	300	mV
Line regulation 2	$\Delta V_{OLN2}$	$20\text{V} \leq V_{IN} \leq 26\text{V}$		3	150	mV
Load regulation 1	$\Delta V_{OLD1}$	$5\text{mA} \leq I_O \leq 1.5\text{A}$			300	mV
Load regulation 2	$\Delta V_{OLD2}$	$250\text{mA} \leq I_O \leq 750\text{mA}$			150	mV
Current dissipation	$I_{CC}$				8.0	mA
Current dissipation variation (Line)	$\Delta I_{CCLN}$	$17.5\text{V} \leq V_{IN} \leq 30\text{V}$			1.0	mA
Current dissipation variation (Load)	$\Delta I_{CCLD}$	$5\text{mA} \leq I_O \leq 1\text{A}$			0.5	mA
Output noise voltage	$V_{NO}$	$10\text{Hz} \leq f \leq 100\text{kHz}^*$		90		$\mu\text{V}$
Ripple rejection	$R_r$	$f=120\text{Hz}$ , $18.5\text{V} \leq V_{IN} \leq 28.5\text{V}$	54	70		dB
Dropout voltage	$V_{drop}$	$I_O=1\text{A}$		2.0		V
Output short current	$I_{OS}$	$V_{IN}=35\text{V}$		0.75		A
Peak output current	$I_{OP}$			2.2		A
Output voltage at strobe mode	$V_{O(ston)}$	$V_{IN}=35\text{V}$ , $V_{st}=5\text{V}$ , $I_O=0\text{A}$ , *			0.8	V
Current dissipation at strobe mode	$I_{CC(ston)}$	$V_{IN}=35\text{V}$ , $V_{st}=5\text{V}$ , $I_O=0\text{A}$ , *			3.0	mA
Strobe input current	$I_{st}$	$V_{IN}=35\text{V}$ , $V_{st}=5\text{V}$ , $I_O=0\text{A}$ , *			1.0	mA

## L780S0 Series

[L780S18]

### Recommended Operating Conditions at $T_a=25^\circ\text{C}$

Parameter	Symbol	Conditions	Ratings	Unit
Input voltage range	$V_{IN}$		21.0 to 33.0	V
Output current range	$I_O$		5 to 1000	mA

### Operating Characteristics at $T_j=25^\circ\text{C}$ , $V_{IN}=27\text{V}$ , $I_O=500\text{mA}$ , $V_{st}=0\text{V}$ , $*T_a=25^\circ\text{C}$

Parameter	Symbol	Conditions	Ratings			Unit
			min	typ	max	
Output voltage	$V_{O1}$		17.3	18.0	18.7	V
	$V_{O2}$	$21\text{V} \leq V_{IN} \leq 33\text{V}$ , $5\text{mA} \leq I_O \leq 1\text{A}$	17.1		18.9	V
Line regulation 1	$\Delta V_{OLN1}$	$21\text{V} \leq V_{IN} \leq 33\text{V}$		15	360	mV
Line regulation 2	$\Delta V_{OLN2}$	$24\text{V} \leq V_{IN} \leq 30\text{V}$		5	180	mV
Load regulation 1	$\Delta V_{OLD1}$	$5\text{mA} \leq I_O \leq 1.5\text{A}$			360	mV
Load regulation 2	$\Delta V_{OLD2}$	$250\text{mA} \leq I_O \leq 750\text{mA}$			180	mV
Current dissipation	$I_{CC}$				8.0	mA
Current dissipation variation (Line)	$\Delta I_{CCLN}$	$21\text{V} \leq V_{IN} \leq 33\text{V}$			1.0	mA
Current dissipation variation (Load)	$\Delta I_{CCLD}$	$5\text{mA} \leq I_O \leq 1\text{A}$			0.5	mA
Output noise voltage	$V_{NO}$	$10\text{Hz} \leq f \leq 100\text{kHz}^*$		110		$\mu\text{V}$
Ripple rejection	$R_r$	$f=120\text{Hz}$ , $22\text{V} \leq V_{IN} \leq 32\text{V}$	53	69		dB
Dropout voltage	$V_{drop}$	$I_O=1\text{A}$		2.0		V
Output short current	$I_{OS}$	$V_{IN}=35\text{V}$		0.75		A
Peak output current	$I_{OP}$			2.2		A
Output voltage at strobe mode	$V_{O(ston)}$	$V_{IN}=35\text{V}$ , $V_{st}=5\text{V}$ , $I_O=0\text{A}$ , *			0.8	V
Current dissipation at strobe mode	$I_{CC(ston)}$	$V_{IN}=35\text{V}$ , $V_{st}=5\text{V}$ , $I_O=0\text{A}$ , *			3.0	mA
Strobe input current	$I_{st}$	$V_{IN}=35\text{V}$ , $V_{st}=5\text{V}$ , $I_O=0\text{A}$ , *			1.0	mA

### Package Dimensions

unit : mm

3079C

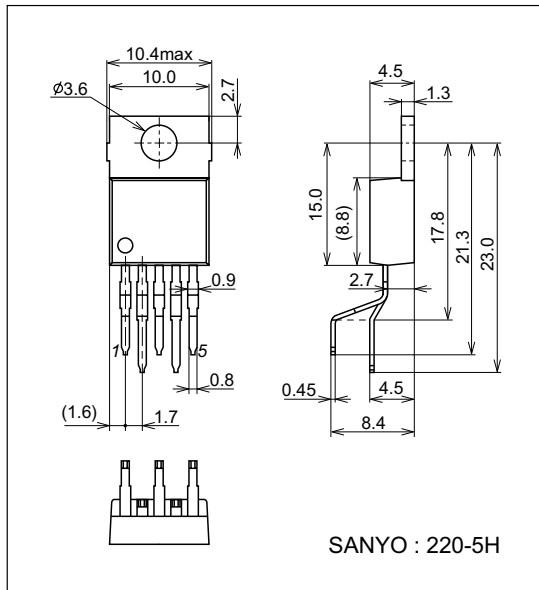

# L780S00 Series

## Equivalent Circuit Block Diagram

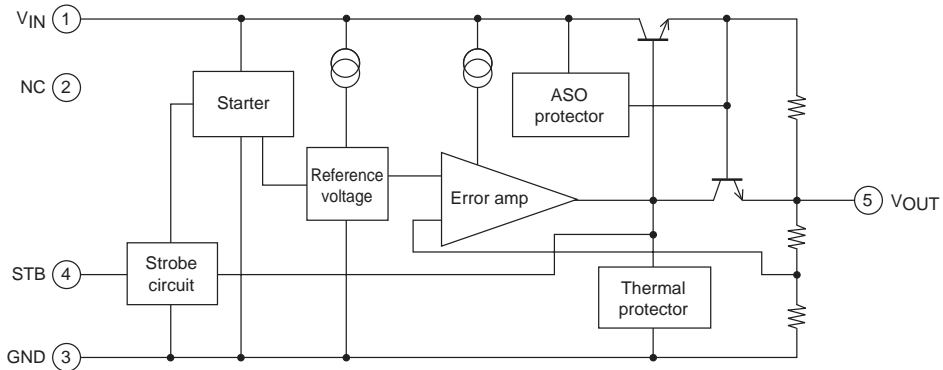

IL00073

## DC Characteristics Test Circuit (Common to L780S00 series)

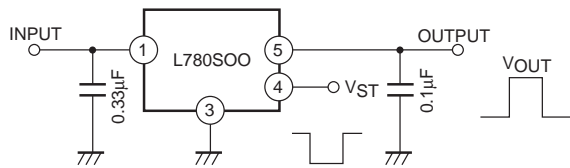

IL00072

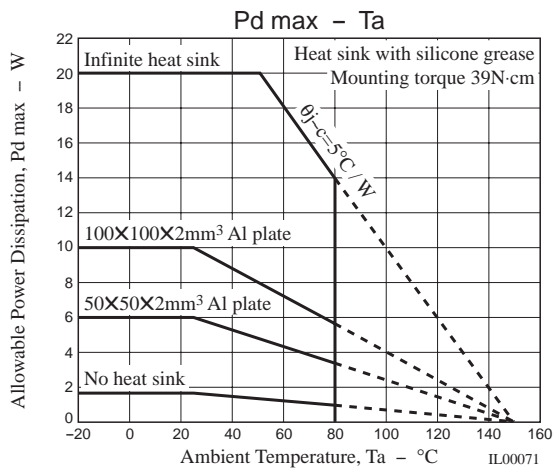

IL00071

# L780S00 Series

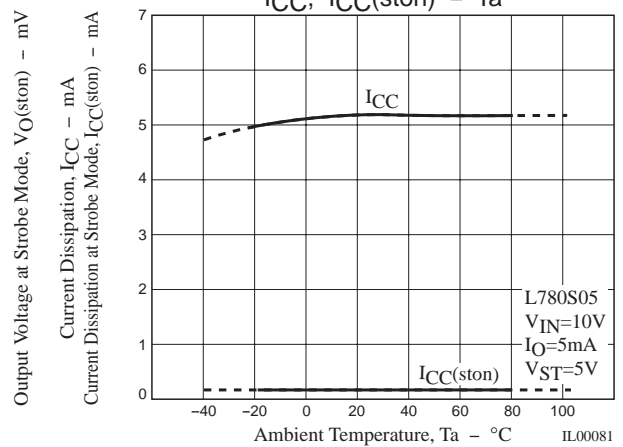
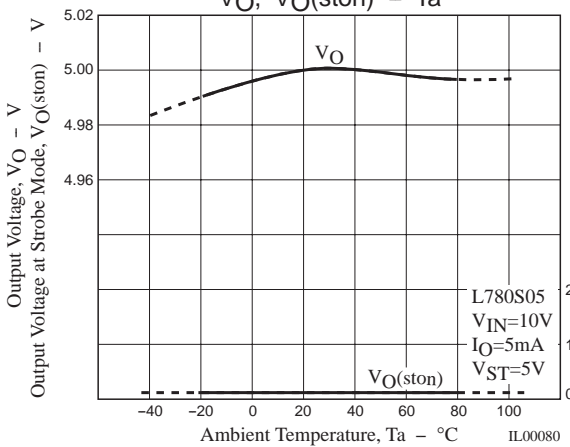
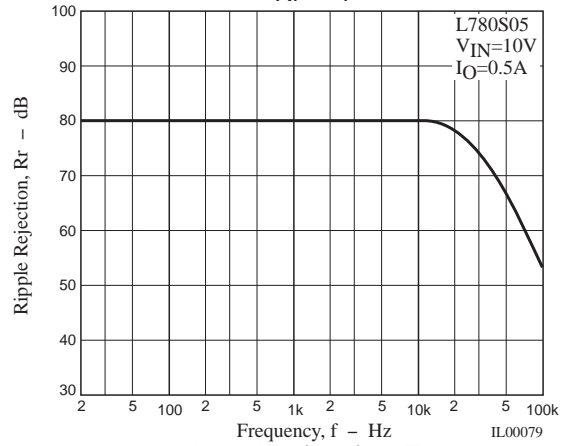
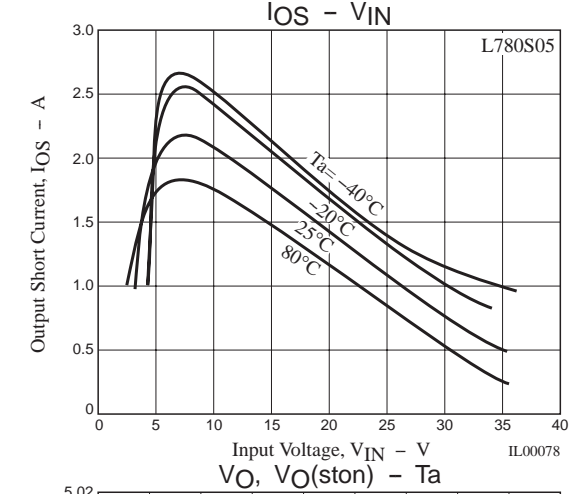
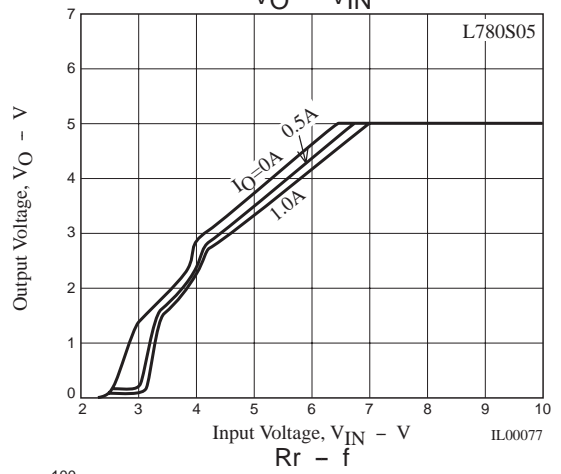
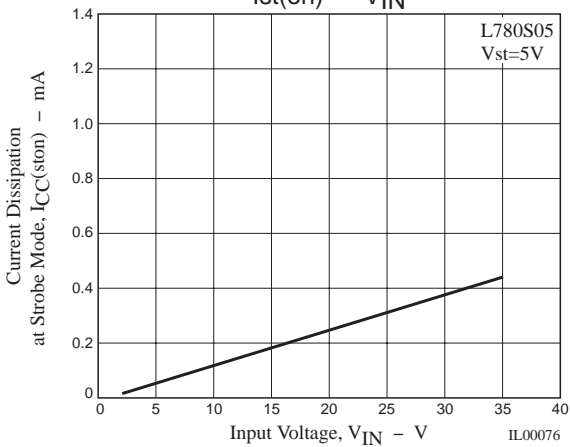
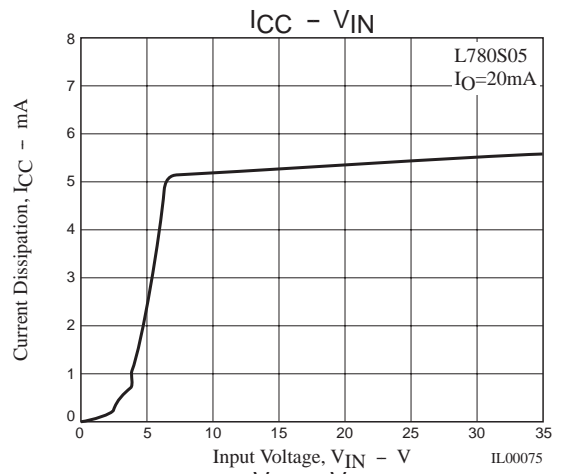
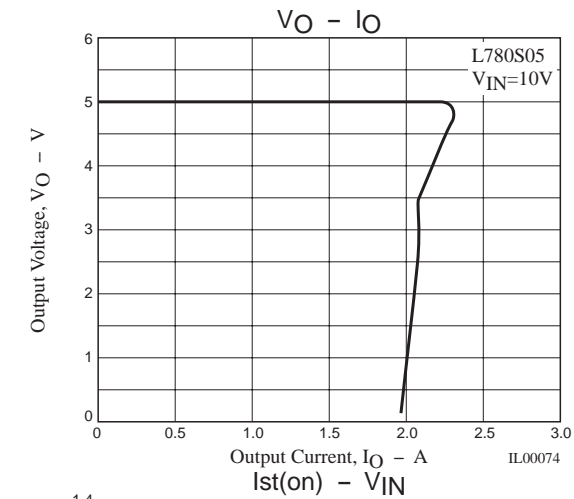

## L780S00 Series

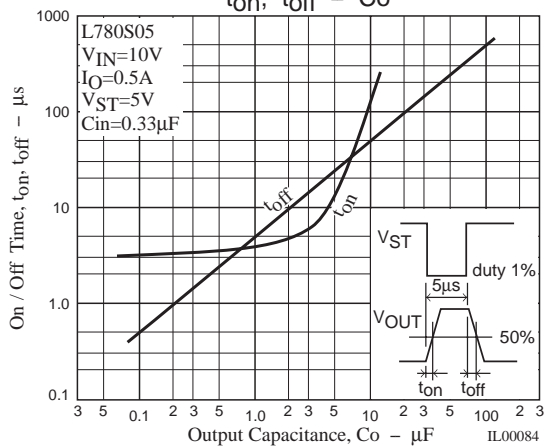
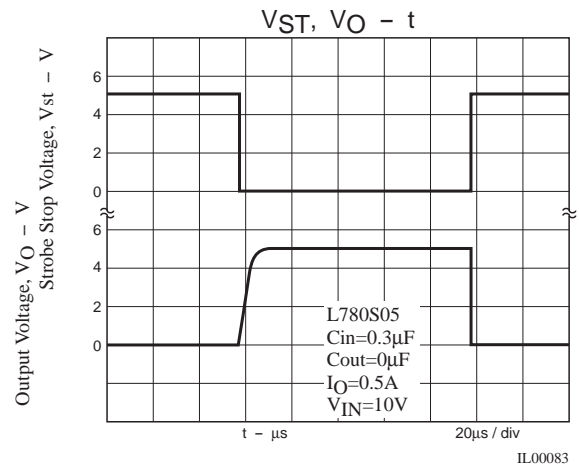
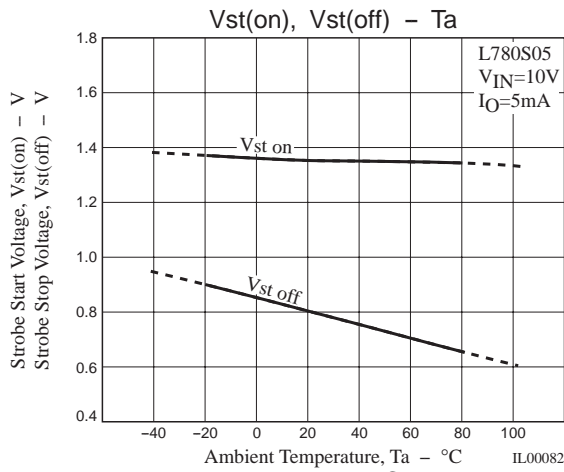

- Specifications of any and all SANYO Semiconductor products described or contained herein stipulate the performance, characteristics, and functions of the described products in the independent state, and are not guarantees of the performance, characteristics, and functions of the described products as mounted in the customer's products or equipment. To verify symptoms and states that cannot be evaluated in an independent device, the customer should always evaluate and test devices mounted in the customer's products or equipment.
- SANYO Semiconductor Co., Ltd. strives to supply high-quality high-reliability products. However, any and all semiconductor products fail with some probability. It is possible that these probabilistic failures could give rise to accidents or events that could endanger human lives, that could give rise to smoke or fire, or that could cause damage to other property. When designing equipment, adopt safety measures so that these kinds of accidents or events cannot occur. Such measures include but are not limited to protective circuits and error prevention circuits for safe design, redundant design, and structural design.
- In the event that any or all SANYO Semiconductor products (including technical data, services) described or contained herein are controlled under any of applicable local export control laws and regulations, such products must not be exported without obtaining the export license from the authorities concerned in accordance with the above law.
- No part of this publication may be reproduced or transmitted in any form or by any means, electronic or mechanical, including photocopying and recording, or any information storage or retrieval system, or otherwise, without the prior written permission of SANYO Semiconductor Co., Ltd.
- Any and all information described or contained herein are subject to change without notice due to product/technology improvement, etc. When designing equipment, refer to the "Delivery Specification" for the SANYO Semiconductor product that you intend to use.
- Information (including circuit diagrams and circuit parameters) herein is for example only; it is not guaranteed for volume production. SANYO Semiconductor believes information herein is accurate and reliable, but no guarantees are made or implied regarding its use or any infringements of intellectual property rights or other rights of third parties.

This catalog provides information as of June, 2006. Specifications and information herein are subject to change without notice.