

25–40 W DC/DC Power Modules 48 V Input Series

- Single, dual and triple output
- 10.7 mm (0.42 in.), allows 0.8 in. board spacing
- 1,500 Vdc isolation voltage
- MTBF > 2 million hours at +75 °C case temperature
- Complete, no extra filters or heatsinks required



The 25–40 watts PKE 4000 series hybrid DC/DC power modules are especially designed for decentralized 48/60 VDC power distribution systems with distributed on-board DC/DC converters in applications with high temperature and isolation requirements.

By using a thickfilm technology, which provides a high degree of integration as well as an efficient thermal management and by utilizing a 300 kHz switching frequency technology based on proprietary drive & control chips, the highly reliable products conform to the most stringent telecom and datacom requirements in harsh environment applications. Input to output isolation is as high as 1,500 Vdc and

mechanical ruggedness in conformance to IEC 68-2 – is close to the requirements for discrete components. The converters can operate in free convection with full output power at ambient temperatures from –45 to +85°C, making the products ideal for the most de-manding temperature requirements in both indoor and outdoor tele/datacom applications.

These products are manufactured using highly automated manufacturing lines with a world-class quality commitment and a five-year warranty. Ericsson Microelectronics AB has been an ISO 9001 certified supplier since 1991. *For a complete product program please reference the back cover.*

General

Absolute Maximum Ratings

Characteristics		min	max	Unit
T _C	Case temperature @ max output power ¹⁾		+ 115	°C
T _S	Storage temperature	-55	+125	°C
V _I	Input voltage	-0.5	+75	V dc
V _{ISO}	Isolation voltage (input to output test voltage)	1,500		V dc
V _{RC}	Remote control voltage pin 1	0	+5	V dc
V _{adj}	Output adjust voltage pin 10	0	V _O	V dc
V _{tr}	Transient input energy @ T _A = +25°C		1.3	Ws

Stress in excess of Absolute Maximum Ratings may cause permanent damage. Absolute Maximum Ratings, sometimes referred to as no destruction limits, are normally tested with one parameter at a time exceeding the limits of Output data or Electrical Characteristics. If exposed to stress above these limits, function and performance may degrade in an unspecified manner.

Input T_C < T_C max

Characteristics		Conditions	min	typ	max	Unit
V _I	Input voltage range ²⁾		38		72	V
V _{off}	Turn-off input voltage	(See Operating Information)		32		V
V _{on}	Turn-on input voltage	(See Operating Information)		33		V
r _{Irush}	Equivalent inrush current resistance			30		mΩ
C _I	Input capacitance			1.8		μF
I _d	Quiescent drain current	I _O =0, T _C = -0...+95°C		15	30	mA

Environmental Characteristics

Characteristics	Test procedure & conditions		
Vibration (Sinusoidal)	IEC 68-2-6 F _C	Frequency Amplitude Acceleration Number of cycles	10...500 Hz 0.75 mm 10 g 10 in each axis
Shock (Half sinus)	IEC 68-2-27 E _a	Peak acceleration Shock duration	200 g 3 ms
Bump (Half sinus)	IEC 68-2-29 E _b	Peak acceleration Bump duration Number of bumps	40 g 6 ms 1000 in 6 directions
Temperature change	IEC 68-2-14 N _a	Temperature Number of cycles	-40°C...+125°C 10
Damp heat	IEC 68-2-3 C _a	Temperature Duration	40°C 56 days
Heat/humidity	IEC 68-2-3 C _a with bias	Temperature Humidity Duration	85°C 85% RH 500 hours

Notes:

¹⁾ Corresponding ambient temp. range (T_A) at full output power is -45 to +85 °C. (Exceptions: PKE 4210 PI = -45 to +75 °C, PKE 4411 PI and PKE 4431 PI = -45 to +60 °C.)

²⁾ The input voltage range 38...72 V meets the requirements in the European Telecom Standard prETS 300 132-2 for Normal input voltage range in 48 V and 60 V DC power systems, -40.5...-57.0 V and -50.0...-72.0 V respectively. At input voltages exceeding 72 V (abnormal voltage) the power loss will be higher than at normal input voltage and T_C must be limited to max +90°C. Absolute max continuous input voltage is 75 V dc. Output characteristics will be marginally affected at input voltages exceeding 72 V.

Safety

The PKE 4000 I Series DC/DC power modules are designed in accordance with EN 60 950 *Safety of information technology equipment including electrical business equipment*, and certified by SEMKO.

The isolation is an operational insulation in accordance with EN 60 950.

The PKE DC/DC power modules are recognized by UL and meet the applicable requirements in UL 1950 *Safety of information technology equipment*, the applicable Canadian safety requirements and UL 1012 *Standard for power supplies*.

The DC/DC power module shall be installed in an end-use equipment and is intended to be supplied by isolated secondary circuitry and shall be installed in compliance with the requirements of the ultimate application. When the supply to the DC/DC power module meets all the requirements for SELV (<60Vdc), the output is considered to remain within SELV limits (level 3). If connected to a 60 V DC power system, reinforced insulation must be provided in the power supply that isolates the input from the ac mains. Single fault testing in the power supply must be performed in combination with the DC/DC power module to demonstrate that the output meets the requirement for SELV. One pole of the input and one pole of the output is to be grounded or both are to be kept floating.

The terminal pins are only intended for connection to mating connectors of internal wiring inside the end-use equipment.

These DC/DC power modules may be used in telephone equipment in accordance with paragraph 34 A.1 of UL 1459 (Standard for Telephone Equipment, second edition).

The isolation voltage is a galvanic isolation and is verified in an electric strength test. Test voltage between input and output is 1,500 V dc.

The capacitor between input and output has a value of 4.7 nF and the leakage current is less than 1μA @ 50 Vdc.

Flammability ratings of the terminal support and internal plastic construction details meet UL 94V-0.

Mechanical Data

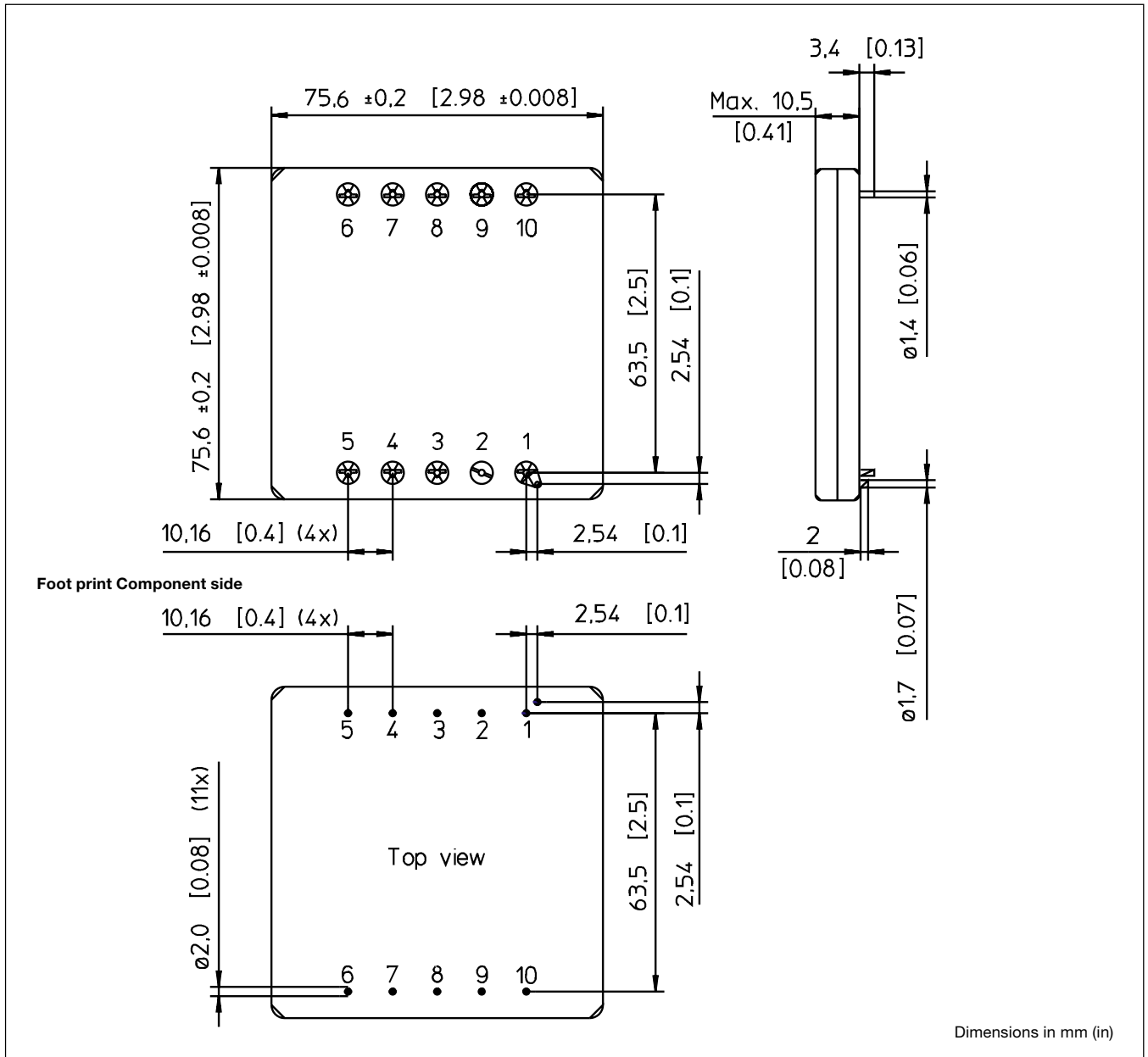

Connections

Pin	Designation	Function
1	RC	Remote Control. To turn-on and turn-off the output.
2	Case	Connected to bottom cover.
3	+In	Positive input.
4	-In	Negative input.
5	Aux	Auxiliary.
6	NC/-Out 2/-Out 3	Not Connected in singles. Negative output 2 in duals. Negative output 3 in triples
7	NC/+Out 2	Not Connected in singles. Positive output 2 in duals and triples.
8	-Out1/Rtn	Negative output1 in singles and duals. Return in triples.
9	+Out 1	Positive output 1 in all models.
10	V _{adj}	Output voltage adjust.

Weight

Maximum 75 g (2.66 oz).

Case

Blue anodized aluminum case with a plastic bottom cover and with tin plated brass pins.

Electrical Data

Fundamental circuit diagrams

Single output

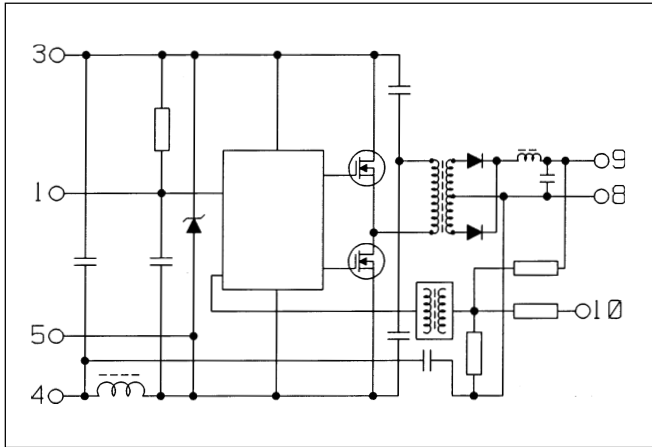

Dual output

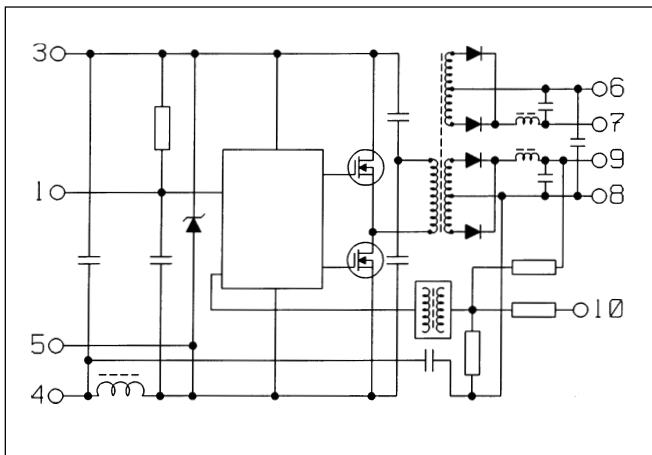

Triple output

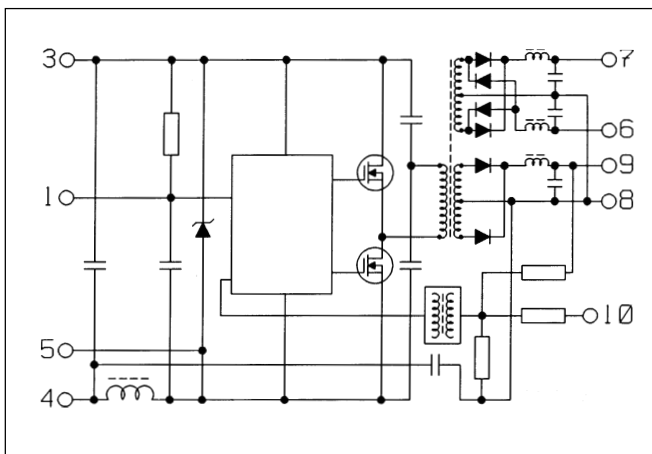

PKE 4210 PI

$T_C = 0 \dots +95^\circ\text{C}$, $V_I = 38 \dots 72\text{V}$ unless otherwise specified.

Output

Characteristics		Conditions		Output 1			Unit
				min	typ	max	
V_{O_i}	Output voltage initial setting and accuracy	$T_C = +25^\circ\text{C}$, $I_O = 7.6\text{ A}$, $V_I = 50\text{ V}$		3.28	3.30	3.32	V
	Output adjust range ¹⁾			3.14		3.47	V
V_O	Output voltage tolerance band	Long term drift included	$I_O = 0.1 \dots 1.0 \times I_{O_{\text{max}}}$	3.20		3.42	V
	Idling voltage	$I_O = 25\text{ mA}$				4.0	V
	Line regulation	$I_O = I_{O_{\text{max}}}$	$V_I = 38 \dots 72\text{ V}$			40	mV
	Load regulation	$I_O = 0.1 \dots 1.0 \times I_{O_{\text{max}}}$, $V_I = 50\text{ V}$				40	mV
t_{tr}	Load transient recovery time	$I_O = 0.1 \dots 1.0 \times I_{O_{\text{max}}}$, $V_I = 50\text{ V}$ load step = $0.5 \times I_{O_{\text{max}}}$			50		μs
V_{tr}	Load transient voltage	$\frac{di}{dt} \leq 0.1\text{ A}/\mu\text{s}$			-480		mV
					270		mV
t_r	Ramp-up time	$I_O = 0.1 \dots 1.0 \times I_{O_{\text{max}}}$	$0.1 \dots 0.9 \times V_O$		15		ms
t_s	Start-up time		From V_I connection to $V_O = 0.9 \times V_{O_i}$		30		ms
I_O	Output current			0		7.6	A
$P_{O_{\text{max}}}$	Max output power ²⁾			25			W
I_{lim}	Current limiting threshold	$T_C < T_{C_{\text{max}}}$		102			%
I_{sc}	Short circuit current ¹⁾						A
$V_{O_{ac}}$	Output ripple	$I_O = I_{O_{\text{max}}}$	20 Hz ... 5 MHz		70	90	mV _{p-p}
SVR	Supply voltage rejection (ac)	$f = 100\text{ Hz}$ sine wave, 1 V_{p-p} , $V_I = 50\text{ V}$ ($\text{SVR} = 20 \log(1\text{ V}_{p-p}/V_{O_{p-p}})$)		50			dB

¹⁾ See Operating Information.

²⁾ See Typical Characteristics, Power derating.

Miscellaneous

Characteristics		Conditions		min	typ	max	Unit
η	Efficiency	$I_O = I_{O_{\text{max}}}$, $V_I = 50\text{ V}$, $T_C = +25^\circ\text{C}$		75	78		%
P_d	Power dissipation	$I_O = I_{O_{\text{max}}}$, $V_I = 50\text{ V}$, $T_C = +25^\circ\text{C}$			7.1	8.3	W

PKE 4211 PI

$T_C = 0 \dots +95^\circ\text{C}$, $V_I = 38 \dots 72\text{V}$ unless otherwise specified.

Output

Characteristics		Conditions		Output 1			Unit
				min	typ	max	
V_{O_i}	Output voltage initial setting and accuracy	$T_C = +25^\circ\text{C}$, $I_O = 5.0\text{ A}$, $V_I = 50\text{ V}$		5.10	5.13	5.16	V
	Output adjust range ¹⁾			4.87		5.39	V
V_O	Output voltage tolerance band	Long term drift included	$I_O = 0.1 \dots 1.0 \times I_{O_{\text{max}}}$	5.03		5.29	V
	Idling voltage	$I_O = 25\text{ mA}$				5.45	V
	Line regulation	$I_O = I_{O_{\text{max}}}$	$V_I = 38 \dots 72\text{ V}$			60	mV
	Load regulation	$I_O = 0.1 \dots 1.0 \times I_{O_{\text{max}}}$, $V_I = 50\text{ V}$				60	mV
t_{tr}	Load transient recovery time	$I_O = 0.1 \dots 1.0 \times I_{O_{\text{max}}}$, $V_I = 50\text{ V}$ load step = $0.5 \times I_{O_{\text{max}}}$			50		μs
V_{tr}	Load transient voltage	$\frac{di}{dt} \leq 0.1\text{ A}/\mu\text{s}$			-410		mV
					270		mV
t_r	Ramp-up time	$I_O = 0.1 \dots 1.0 \times I_{O_{\text{max}}}$	$0.1 \dots 0.9 \times V_O$		15		ms
t_s	Start-up time		From V_I connection to $V_O = 0.9 \times V_{O_i}$		30		ms
I_O	Output current			0		5.0	A
$P_{O_{\text{max}}}$	Max output power ²⁾			25			W
I_{lim}	Current limiting threshold	$T_C < T_{C_{\text{max}}}$		102			%
I_{sc}	Short circuit current ¹⁾						A
$V_{O_{ac}}$	Output ripple	$I_O = I_{O_{\text{max}}}$	20 Hz ... 5 MHz		60	90	mV _{p-p}
SVR	Supply voltage rejection (ac)	$f = 100\text{ Hz}$ sine wave, 1 V_{p-p} , $V_I = 50\text{ V}$ ($SVR = 20 \log(1 \text{ V}_{p-p}/V_{O_{p-p}})$)		50			dB

¹⁾ See Operating Information.

²⁾ See Typical Characteristics, Power derating.

Miscellaneous

Characteristics		Conditions		min	typ	max	Unit
η	Efficiency	$I_O = I_{O_{\text{max}}}$, $V_I = 50\text{ V}$, $T_C = +25^\circ\text{C}$		80	84		%
P_d	Power dissipation	$I_O = I_{O_{\text{max}}}$, $V_I = 50\text{ V}$, $T_C = +25^\circ\text{C}$			4.8	6.3	W

PKE 4411 PI

$T_C = 0 \dots +95^\circ\text{C}$, $V_I = 38 \dots 72\text{V}$ unless otherwise specified.

Output

Characteristics		Conditions		Output 1			Unit
				min	typ	max	
V_{OI}	Output voltage initial setting and accuracy	$T_C = +25^\circ\text{C}$, $I_O = 8.0\text{ A}$, $V_I = 50\text{ V}$		5.10	5.13	5.16	V
	Output adjust range ¹⁾			4.87		5.39	V
V_O	Output voltage tolerance band	Long term drift included	$I_O = 0.1 \dots 1.0 \times I_{O\text{max}}$	5.02		5.31	V
	Idling voltage	$I_O = 55\text{ mA}$				5.45	V
	Line regulation	$I_O = I_{O\text{max}}$	$V_I = 38 \dots 72\text{ V}$			60	mV
	Load regulation	$I_O = 0.1 \dots 1.0 \times I_{O\text{max}}$, $V_I = 50\text{ V}$				70	mV
t_{tr}	Load transient recovery time	$I_O = 0.1 \dots 1.0 \times I_{O\text{max}}$, $V_I = 50\text{ V}$ load step = $0.5 \times I_{O\text{max}}$			50		μs
V_{tr}	Load transient voltage	$\frac{di}{dt} \leq 0.1\text{ A}/\mu\text{s}$			-500		mV
					380		mV
t_r	Ramp-up time	$I_O = 0.1 \dots 1.0 \times I_{O\text{max}}$	$0.1 \dots 0.9 \times V_O$		15		ms
t_s	Start-up time		From V_I connection to $V_O = 0.9 \times V_{OI}$		30		ms
I_O	Output current			0		8.0	A
$P_{O\text{max}}$	Max output power ²⁾			40			W
I_{lim}	Current limiting threshold	$T_C < T_{C\text{max}}$		102			%
I_{sc}	Short circuit current ¹⁾						A
$V_{O\text{ac}}$	Output ripple	$I_O = I_{O\text{max}}$	20 Hz ... 5 MHz			120	mV _{p-p}
SVR	Supply voltage rejection (ac)	$f = 100\text{ Hz}$ sine wave, 1 V_{p-p} , $V_I = 50\text{ V}$ ($\text{SVR} = 20 \log(1\text{ V}_{p-p}/V_{O\text{p-p}})$)		50			dB

¹⁾ See Operating Information.

²⁾ See Typical Characteristics, Power derating.

Miscellaneous

Characteristics		Conditions		min	typ	max	Unit
η	Efficiency	$I_O = I_{O\text{max}}$, $V_I = 50\text{ V}$, $T_C = +25^\circ\text{C}$		78	83		%
P_d	Power dissipation	$I_O = I_{O\text{max}}$, $V_I = 50\text{ V}$, $T_C = +25^\circ\text{C}$			8.2	11.0	W

PKE 4323 PI

$T_C = 0 \dots +95^\circ\text{C}$, $V_I = 38 \dots 72\text{V}$ unless otherwise specified. $I_{O1\text{ nom}} = 1.25\text{ A}$, $I_{O2\text{ nom}} = 1.25\text{ A}$.

Output

Characteristics		Conditions		Output 1			Output 2			Unit	
				min	typ	max	min	typ	max		
V_{O_i}	Output voltage initial setting and accuracy	$T_C = +25^\circ\text{C}$, $I_O = I_{O\text{ nom}}$, $V_I = 50\text{ V}$		11.90	12.00	12.10	11.80	12.00	12.20	V	
	Output adjust range ¹⁾			11.40		12.60	11.40		12.60	V	
V_O	Output voltage tolerance band	Long term drift included	$I_O = 0.1 \dots 1.0 \times I_{O\text{ nom}}$	11.74		12.41	11.31		12.85	V	
	Idling voltage	$I_O = 25\text{ mA}$				12.5			16.4	V	
	Line regulation	$I_O = I_{O\text{ nom}}$	$V_I = 38 \dots 72\text{ V}$			170			190	mV	
	Load regulation	$I_{O1} = 0.1 \dots 1.0 \times I_{O1\text{ nom}}$, $I_{O2} = I_{O2\text{ nom}}$, $V_I = 50\text{ V}$				140				mV	
t_{tr}	Load transient recovery time	$I_O = 0.1 \dots 1.0 \times I_{O\text{ nom}}$, $V_I = 50\text{ V}$ load step = $0.5 \times I_{O1\text{ nom}}$, $I_{O2} = I_{O2\text{ nom}}$				100				μs	
V_{tr}	Load transient voltage	$\frac{di}{dt} \leq 0.1\text{ A}/\mu\text{s}$				-130				mV	
						80				mV	
t_r	Ramp-up time	$I_O = 0.1 \dots 1.0 \times I_{O\text{ nom}}$	$0.1 \dots 0.9 \times V_O$			15			15	ms	
t_s	Start-up time		From V_I connection to $V_O = 0.9 \times V_{O_i}$			30			30	ms	
I_O	Output current			0		2	0		1.25	A	
$P_{O\text{ max}}$	Max total output power ²⁾			min 30W, max 15W on Out 2						W	
I_{lim}	Current limiting threshold	$T_C < T_{C\text{ max}}$		min $102 \times P_{O\text{ max}}^3)$						%	
I_{sc}	Short circuit current ¹⁾									A	
$V_{O\text{ ac}}$	Output ripple	$I_O = I_{O\text{ nom}}$	20 Hz...5 MHz			90	140		90	140	mV _{p-p}
SVR	Supply voltage rejection (ac)	$f = 100\text{ Hz}$ sine wave, $1 V_{p-p}$, $V_I = 50\text{ V}$ ($\text{SVR} = 20 \log(1 V_{p-p}/V_{O\text{ p-p}})$)		43			43				dB

¹⁾ See Operating Information.

²⁾ See Typical Characteristics, Power derating.

³⁾ I_{lim} on each output is set by the total load.

Miscellaneous

Characteristics		Conditions	min	typ	max	Unit
η	Efficiency	$I_O = I_{O\text{ nom}}$, $V_I = 50\text{ V}$, $T_C = +25^\circ\text{C}$	83	87		%
P_d	Power dissipation	$I_O = I_{O\text{ nom}}$, $V_I = 50\text{ V}$, $T_C = +25^\circ\text{C}$		4.9	6.1	W

PKE 4325 PI

$T_C = 0 \dots +95^\circ\text{C}$, $V_I = 38 \dots 72\text{V}$ unless otherwise specified. $I_{O1\text{ nom}} = 1.0\text{ A}$, $I_{O2\text{ nom}} = 1.0\text{ A}$.

Output

Characteristics		Conditions		Output 1			Output 2			Unit		
				min	typ	max	min	typ	max			
V_{O_i}	Output voltage initial setting and accuracy	$T_C = +25^\circ\text{C}$, $I_O = I_{O\text{ nom}}$, $V_I = 50\text{ V}$		14.88	15.00	15.12	14.70	15.00	15.30	V		
	Output adjust range ¹⁾			14.25		15.75		14.25		15.75		V
V_O	Output voltage tolerance band	Long term drift included	$I_O = 0.1 \dots 1.0 \times I_{O\text{ nom}}$	14.68		15.49		14.16		16.01		V
	Idling voltage	$I_O = 25\text{ mA}$		15.3			22.0			V		
	Line regulation	$I_O = I_{O\text{ nom}}$	$V_I = 38 \dots 72\text{ V}$	210			240			mV		
	Load regulation	$I_{O1} = 0.1 \dots 1.0 \times I_{O1\text{ nom}}$, $I_{O2} = I_{O2\text{ nom}}$, $V_I = 50\text{ V}$		180						mV		
t_{tr}	Load transient recovery time	$I_O = 0.1 \dots 1.0 \times I_{O\text{ nom}}$, $V_I = 50\text{ V}$ load step = $0.5 \times I_{O1\text{ nom}}$, $I_{O2} = I_{O2\text{ nom}}$		100						μs		
V_{tr}	Load transient voltage	$\frac{di}{dt} \leq 0.1\text{ A}/\mu\text{s}$		-120						mV		
				70						mV		
t_r	Ramp-up time	$I_O = 0.1 \dots 1.0 \times I_{O\text{ nom}}$	$0.1 \dots 0.9 \times V_O$	15			15			ms		
t_s	Start-up time		From V_I connection to $V_O = 0.9 \times V_{O_i}$	30			30			ms		
I_O	Output current			0		1.6		0		1.0		A
$P_{O\text{ max}}$	Max total output power ²⁾			min 30W, max 15W on Out 2						W		
I_{lim}	Current limiting threshold	$T_C < T_{C\text{ max}}$		min $102 \times P_{O\text{ max}}^3)$						%		
I_{sc}	Short circuit current ¹⁾									A		
$V_{O\text{ ac}}$	Output ripple	$I_O = I_{O\text{ nom}}$	20 Hz ... 5 MHz	90		140		90		140		mV _{p-p}
SVR	Supply voltage rejection (ac)	$f = 100\text{ Hz}$ sine wave, $1 V_{p-p}$, $V_I = 50\text{ V}$ (SVR = $20 \log(1 V_{p-p}/V_{O\text{ p-p}})$)		43			43					dB

¹⁾ See Operating Information.

²⁾ See Typical Characteristics, Power derating.

³⁾ I_{lim} on each output is set by the total load.

Miscellaneous

Characteristics		Conditions		min	typ	max	Unit
η	Efficiency	$I_O = I_{O\text{ nom}}$, $V_I = 50\text{ V}$, $T_C = +25^\circ\text{C}$		83	89		%
P_d	Power dissipation	$I_O = I_{O\text{ nom}}$, $V_I = 50\text{ V}$, $T_C = +25^\circ\text{C}$			3.7	6.1	W

PKE 4231 PI

$T_C = 0...+95^\circ\text{C}$, $V_I = 38...72\text{ V}$ unless otherwise specified. $I_{O1nom} = 3.8\text{ A}$, $I_{O2,3nom} = 0.25\text{ A}$

Output

Characteristics		Conditions		Output 1			Output 2			Output 3			Unit
				min	typ	max	min	typ	max	min	typ	max	
V_{O1}	Output voltage initial setting and accuracy	$T_C = +25^\circ\text{C}$, $I_O = I_{Onom}$, $V_I = 50\text{ V}$		5.10	5.13	5.16	11.80	12.20	12.60	-11.90	-12.30	-12.80	V
	Output adjust range ¹⁾			4.87	5.39		11.59	12.81		-11.69	-12.92		V
V_O	Output voltage tolerance band	Long term drift included	$I_{O1} = 0.1...1.0 \times I_{Onom}$, $I_{O2,3} = I_{Onom}$	5.03		5.27		10.89	13.66		-10.89	-13.95	V
	Idling voltage	$I_O = 25\text{ mA}$				5.4		16.2		-16.2		V	
	Line regulation	$I_O = I_{Onom}$	$V_I = 38...72\text{ V}$			50		150		150		mV	
	Load regulation	$I_{O1} = 0.1...1.0 \times I_{Onom}$, $I_{O2,3} = I_{Onom}$, $V_I = 50\text{ V}$				50						mV	
t_{tr}	Load transient recovery time	$I_{O1} = 0.1...1.0 \times I_{Onom}$, $V_I = 50\text{ V}$ load step = $0.8 \times I_{O1nom}$, $I_{O2,3} = I_{Onom}$		50								μs	
V_{tr}	Load transient voltage	$\frac{di}{dt} \leq 0.1\text{ A}/\mu\text{s}$		-240								mV	
				160								mV	
t_r	Ramp-up time	$I_O = 0.1...1.0 \times I_{Onom}$, $V_I = 50\text{ V}$	$0.1...0.9 \times V_O$	15		15		15				ms	
t_s	Start-up time		From V_I connection to $V_O = 0.9 \times V_{O1}$	30		30		30				ms	
I_O	Output current			0	5.0		0	1.0		0	1.0		A
P_{Omax}	Max total output power ²⁾			min 25W, max 15W on Out 2+Out 3								W	
I_{lim}	Current limiting threshold	$T_C < T_{Cmax}$		min $102 \times P_{Omax}$ ³⁾								%	
I_{lim}	Short circuit current ¹⁾												A
V_{Oac}	Output ripple	$I_O = I_{Onom}$	20 Hz...5 MHz	60	90		80	150		80	150		mV_{p-p}
SVR	Supply voltage rejection (ac)	$f = 100\text{ Hz sine wave}$, $1 V_{p-p}$, $V_I = 50\text{ V}$ ($\text{SVR} = 20 \log(1 V_{p-p}/V_{O p-p})$)		50		43		43				dB	

¹⁾ See Operating Information.

²⁾ See Typical Characteristics, Power derating.

³⁾ I_{lim} on each output is set by the total load.

Miscellaneous

Characteristics		Conditions	min	typ	max	Unit
η	Efficiency	$I_O = I_{Onom}$, $V_I = 50\text{ V}$, $T_C = +25^\circ\text{C}$	80	84		%
P_d	Power dissipation	$I_O = I_{Onom}$, $V_I = 50\text{ V}$, $T_C = +25^\circ\text{C}$		4.8	6.3	W

PKE 4232 PI

$T_C = 0...+95^{\circ}\text{C}$, $V_I = 38...72\text{ V}$ unless otherwise specified. $I_{O1nom} = 3.1\text{ A}$, $I_{O2,3nom} = 0.31\text{ A}$

Output

Characteristics		Conditions		Output 1			Output 2			Output 3			Unit	
				min	typ	max	min	typ	max	min	typ	max		
V_{O1}	Output voltage initial setting and accuracy	$T_C = +25^{\circ}\text{C}$, $I_O = I_{Onom}$, $V_I = 50\text{ V}$		5.10	5.13	5.16	14.70	15.15	15.60	-14.80	-15.25	-15.70	V	
	Output adjust range ¹⁾			4.87		5.39	14.39		15.91	-14.49		-16.01	V	
V_O	Output voltage tolerance band	Long term drift included	$I_{O1} = 0.1...1.0 \times I_{Onom}$, $I_{O2,3} = I_{Onom}$	5.03		5.27	13.69		16.79	-13.71		-16.97	V	
	Idling voltage	$I_O = 25\text{ mA}$				5.40			23.0			-23.0	V	
	Line regulation	$I_O = I_{Onom}$	$V_I = 38...72\text{ V}$			50			180			180	mV	
	Load regulation	$I_{O1} = 0.1...1.0 \times I_{Onom}$, $I_{O2,3} = I_{Onom}$, $V_I = 50\text{ V}$				50							mV	
t_{tr}	Load transient recovery time	$I_{O1} = 0.1...1.0 \times I_{Onom}$, $V_I = 50\text{ V}$ load step = $0.8 \times I_{O1nom}$, $I_{O2,3} = I_{Onom}$				50							μs	
V_{tr}	Load transient voltage	$\frac{di}{dt} \leq 0.1\text{ A}/\mu\text{s}$				-170							mV	
						110							mV	
t_r	Ramp-up time	$I_O = 0.1...1.0 \times I_{Onom}$, $V_I = 50\text{ V}$	$0.1...0.9 \times V_O$			15		15				15	ms	
t_s	Start-up time		From V_I connection to $V_O = 0.9 \times V_{O1}$			30		30				30	ms	
I_O	Output current			0		5.0	0		0.8	0		0.8	A	
P_{Omax}	Max total output power ²⁾			min 25W, max 15W on Out 2+Out 3								W		
I_{lim}	Current limiting threshold	$T_C < T_{Cmax}$		min $102 \times P_{Omax}$ ³⁾								%		
I_{lim}	Short circuit current ¹⁾											A		
V_{Oac}	Output ripple	$I_O = I_{Onom}$	20 Hz...5 MHz			60		80		80		140		mV _{p-p}
SVR	Supply voltage rejection (ac)	$f = 100\text{ Hz sine wave}$, 1 V_{p-p} , $V_I = 50\text{ V}$ ($SVR = 20 \log(1\text{ V}_{p-p}/V_{O p-p})$)				50			40			40		dB

¹⁾ See Operating Information.

²⁾ See Typical Characteristics, Power derating.

³⁾ I_{lim} on each output is set by the total load.

Miscellaneous

Characteristics		Conditions	min	typ	max	Unit
η	Efficiency	$I_O = I_{Onom}$, $V_I = 50\text{ V}$, $T_C = +25^{\circ}\text{C}$	80	85		%
P_d	Power dissipation	$I_O = I_{Onom}$, $V_I = 50\text{ V}$, $T_C = +25^{\circ}\text{C}$		4.4	6.3	W

PKE 4235 PI

$T_C = 0...+95^\circ\text{C}$, $V_I = 38...72\text{ V}$ unless otherwise specified. $I_{O1nom} = 2.1\text{ A}$, $I_{O2nom} = 0.31\text{ A}$, $I_{O3nom} = 2.1\text{ A}$

Output

Characteristics		Conditions		Output 1			Output 2			Output 3			Unit
				min	typ	max	min	typ	max	min	typ	max	
V_{O1}	Output voltage initial setting and accuracy	$T_C = +25^\circ\text{C}$, $I_O = I_{Onom}$, $V_I = 50\text{ V}$		5.10	5.13	5.16	11.69	12.05	12.41	-4.97	-5.13	-5.29	V
	Output adjust range ¹⁾			4.87		5.39	11.45		12.65	-4.87		-5.39	V
V_O	Output voltage tolerance band	Long term drift included	$I_{O1} = 0.1...1.0 \times I_{Onom}$, $I_{O2,3} = I_{Onom}$	5.03		5.30	10.80		13.50	-4.55		-5.78	V
	Idling voltage	$I_O = 25\text{ mA}$				5.45			15.90			-6.60	V
	Line regulation	$I_O = I_{Onom}$	$V_I = 38...72\text{ V}$			50			140			60	mV
	Load regulation	$I_{O1} = 0.1...1.0 \times I_{Onom}$, $I_{O2,3} = I_{Onom}$, $V_I = 50\text{ V}$				50							mV
t_{tr}	Load transient recovery time	$I_{O1} = 0.1...1.0 \times I_{Onom}$, $V_I = 50\text{ V}$ load step = $0.8 \times I_{O1nom}$, $I_{O2,3} = I_{Onom}$				50							μs
V_{tr}	Load transient voltage	$\frac{di}{dt} \leq 0.1\text{ A}/\mu\text{s}$				-180							mV
						90							mV
t_r	Ramp-up time	$I_O = 0.1...1.0 \times I_{Onom}$, $V_I = 50\text{ V}$	$0.1...0.9 \times V_O$			15		15			15		ms
t_s	Start-up time		From V_I connection to $V_O = 0.9 \times V_{O1}$			30		30			30		ms
I_O	Output current			0		5.0	0		1.0	0		3.0	A
P_{Omax}	Max total output power ²⁾			min 25W, max 15W on Out 2+Out 3								W	
I_{lim}	Current limiting threshold	$T_C < T_{Cmax}$		min $102 \times P_{Omax}$ ³⁾								%	
I_{lim}	Short circuit current ¹⁾											A	
V_{Oac}	Output ripple	$I_O = I_{Onom}$	20 Hz...5 MHz			100		150			250		mV_{p-p}
SVR	Supply voltage rejection (ac)	$f = 100\text{ Hz sine wave}$, $1V_{p-p}$, $V_I = 50\text{ V}$ ($\text{SVR} = 20 \log(1 \cdot V_{p-p}/V_{O p-p})$)		50			40			40			dB

¹⁾ See Operating Information.

²⁾ See Typical Characteristics, Power derating.

³⁾ I_{lim} on each output is set by the total load.

Miscellaneous

Characteristics		Conditions	min	typ	max	Unit
η	Efficiency	$I_O = I_{Onom}$, $V_I = 50\text{ V}$, $T_C = +25^\circ\text{C}$	80	84		%
P_d	Power dissipation	$I_O = I_{Onom}$, $V_I = 50\text{ V}$, $T_C = +25^\circ\text{C}$		4.8	6.3	W

PKE 4431 PI

$T_C = 0...+95^{\circ}\text{C}$, $V_I = 38...72\text{V}$ unless otherwise specified. $I_{O1nom} = 5.0\text{ A}$, $I_{O2,3nom} = 0.58\text{ A}$

Output

Characteristics		Conditions		Output 1			Output 2			Output 3			Unit
				min	typ	max	min	typ	max	min	typ	max	
V_{O1}	Output voltage initial setting and accuracy	$T_C = +25^{\circ}\text{C}$, $I_O = I_{Onom}$, $V_I = 50\text{ V}$		5.10	5.13	5.16	11.28	12.00	12.72	-11.28	-12.00	-12.72	V
	Output adjust range ¹⁾			4.87	5.39		11.40	12.60		-11.40	-12.60		V
V_O	Output voltage tolerance band	Long term drift included	$I_{O1} = 0.1...1.0 \times I_{Onom}$, $I_{O2,3} = I_{Onom}$	5.03	5.29		11.14	12.99		-11.14	-12.99		V
	Idling voltage	$I_O = 55\text{ mA}$		5.45		15.90		-15.90					V
	Line regulation	$I_O = I_{Onom}$	$V_I = 38...72\text{V}$	60		140		140					mV
	Load regulation	$I_{O1} = 0.1...1.0 \times I_{Onom}$, $I_{O2,3} = I_{Onom}$, $V_I = 50\text{ V}$		70								mV	
t_{tr}	Load transient recovery time	$I_{O1} = 0.1...1.0 \times I_{Onom}$, $V_I = 50\text{ V}$ load step = $0.8 \times I_{O1nom}$, $I_{O2,3} = I_{Onom}$		50								μs	
V_{tr}	Load transient voltage	$\frac{di}{dt} \leq 0.1\text{A}/\mu\text{s}$		-390								mV	
				250								mV	
t_r	Ramp-up time	$I_O = 0.1...1.0 \times I_{Onom}$, $V_I = 50\text{ V}$	$0.1...0.9 \times V_O$	15	15		15						ms
t_s	Start-up time		From V_I connection to $V_O = 0.9 \times V_{O1}$	30	30		30						ms
I_O	Output current			0	7	0	2	0	2				A
P_{Omax}	Max total output power ²⁾			min 40W, max 30W on Out 2+Out 3								W	
I_{lim}	Current limiting threshold	$T_C < T_{Cmax}$		min $102 \times P_{Omax}$ ³⁾								%	
I_{lim}	Short circuit current ¹⁾											A	
V_{Oac}	Output ripple	$I_O = I_{Onom}$	20 Hz...5 MHz	90		150		150					mV _{p-p}
SVR	Supply voltage rejection (ac)	f = 100 Hz sine wave, 1 V _{p-p} , $V_I = 50\text{ V}$ (SVR = $20 \log(1 V_{p-p}/V_{Op-p})$)		50	40		40					dB	

¹⁾ See Operating Information.

²⁾ See Typical Characteristics, Power derating.

³⁾ I_{lim} on each output is set by the total load.

Miscellaneous

Characteristics		Conditions	min	typ	max	Unit
η	Efficiency	$I_O = I_{Onom}$, $V_I = 50\text{ V}$, $T_C = +25^{\circ}\text{C}$	80	84		%
P_d	Power dissipation	$I_O = I_{Onom}$, $V_I = 50\text{ V}$, $T_C = +25^{\circ}\text{C}$		7.6	10.0	W

Typical Characteristics

PKE 4210 PI

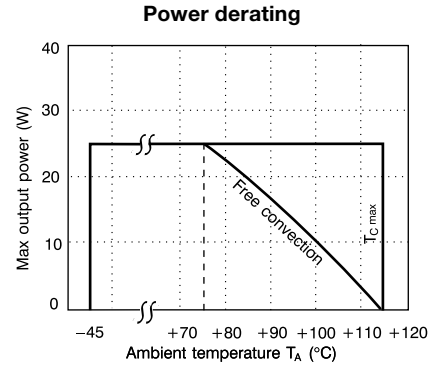
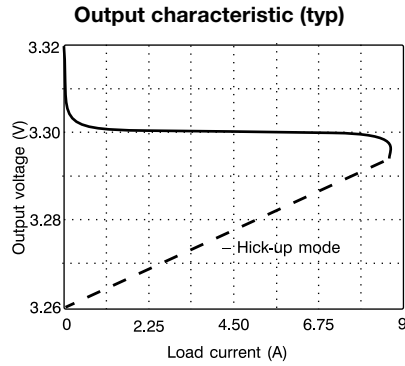
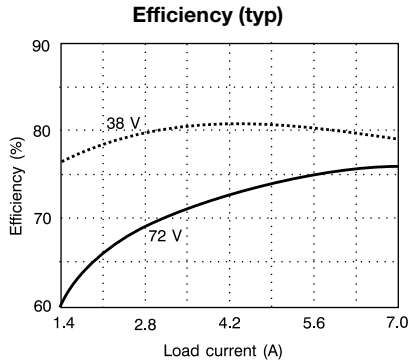

PKE 4211 PI

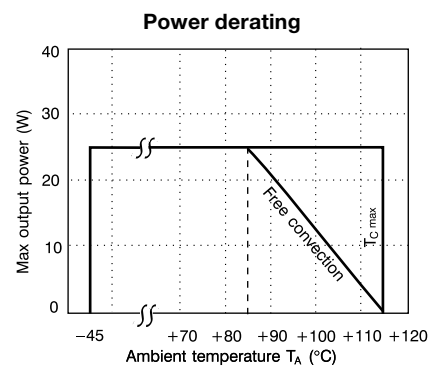
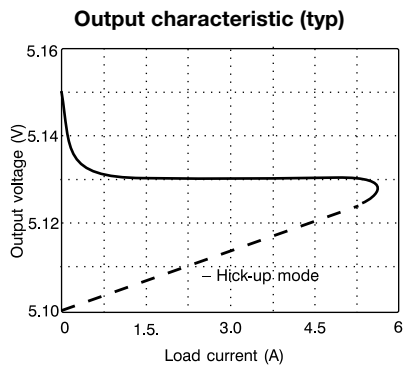
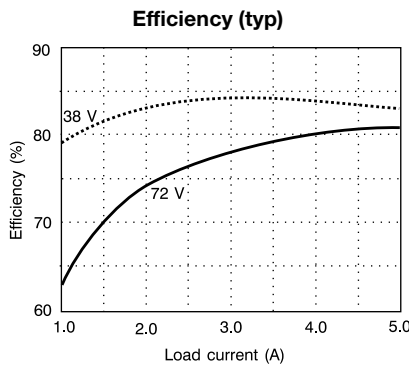

PKE 4411 PI

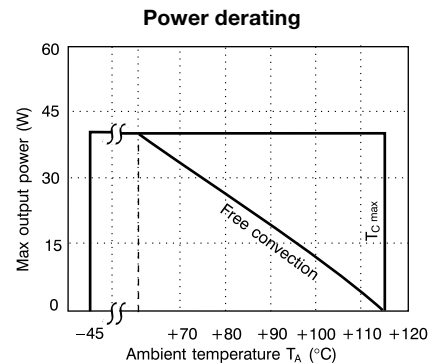
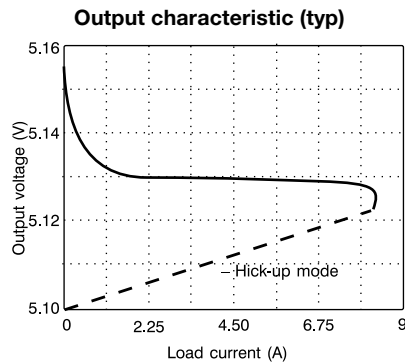
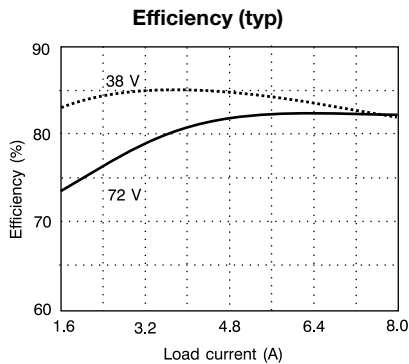

PKE 4323 PI

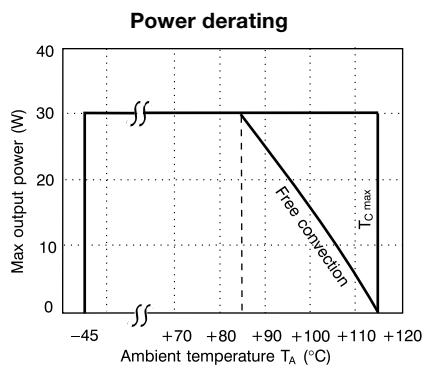
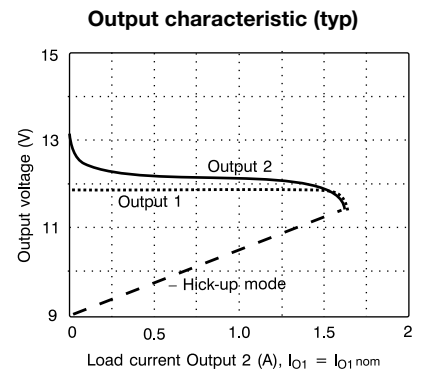
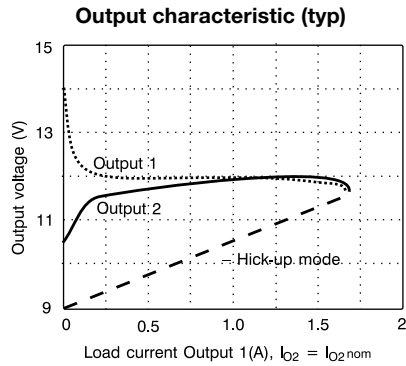
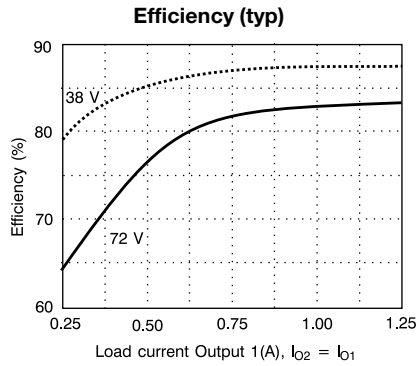

PKE 4325 PI

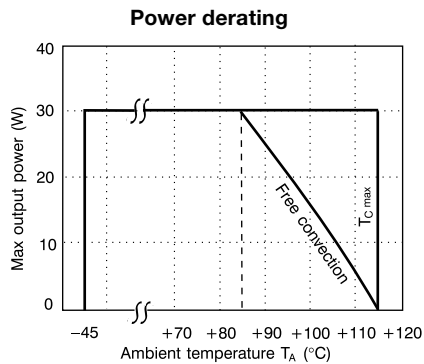
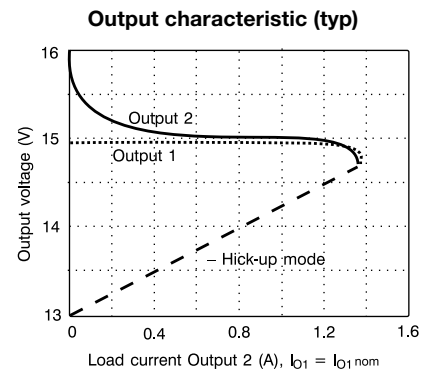
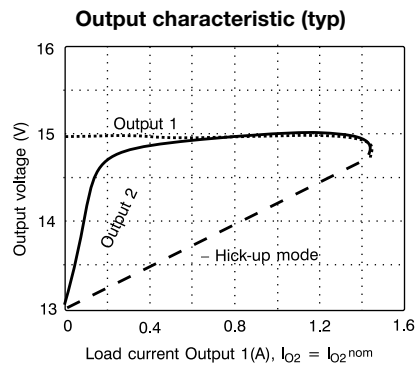
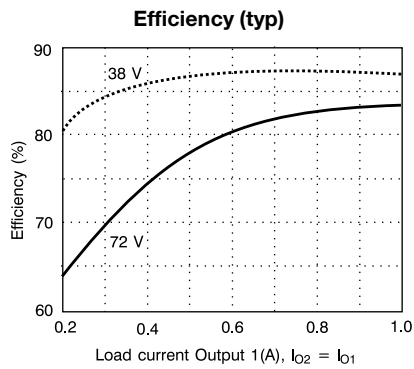

PKE 4231 PI

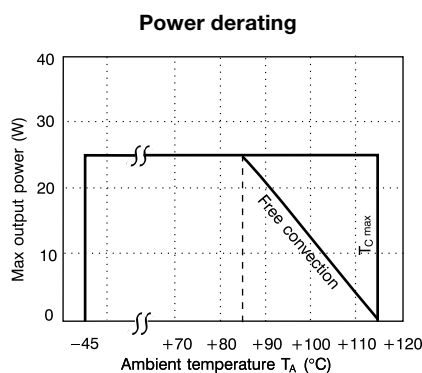
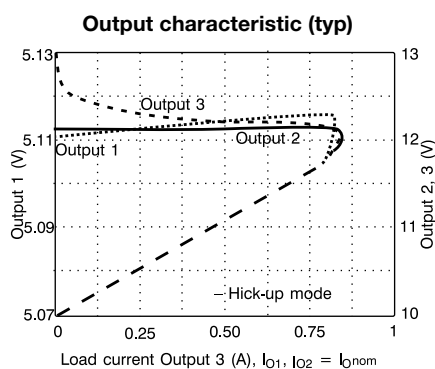
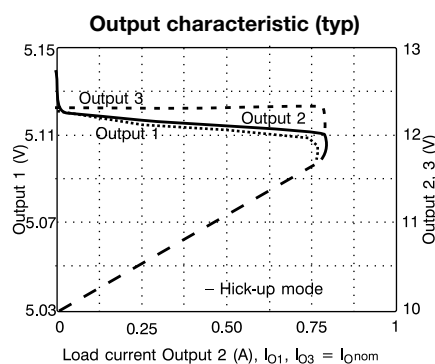
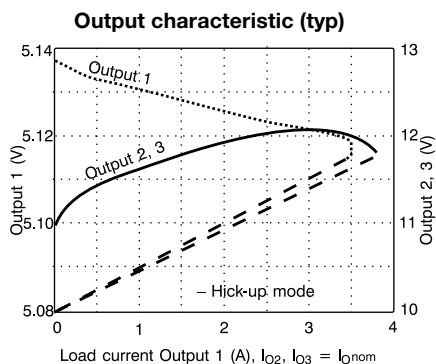
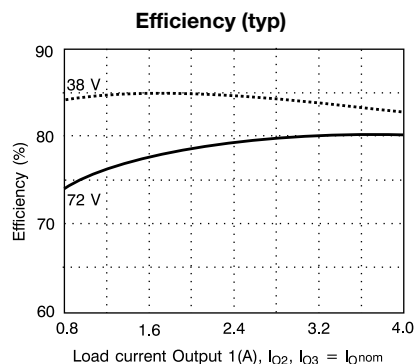

PKE 4232 PI

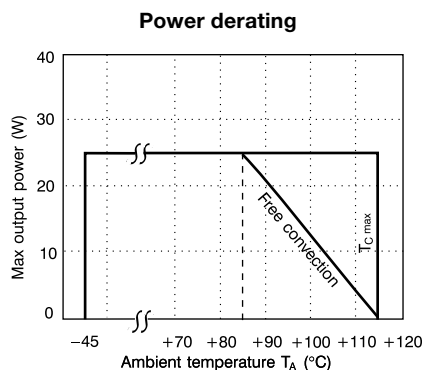
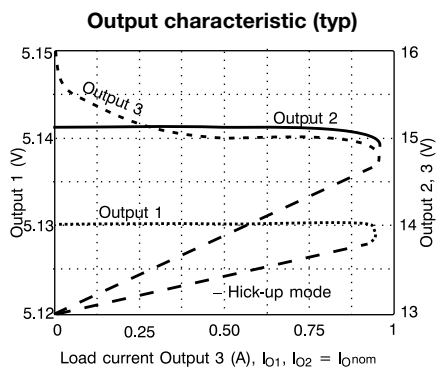
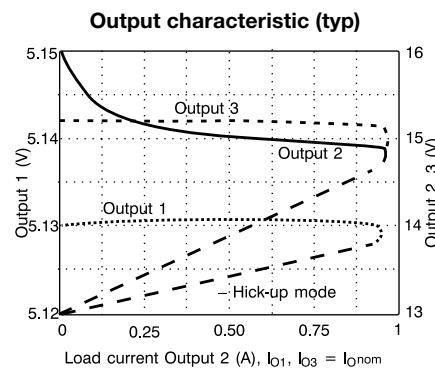
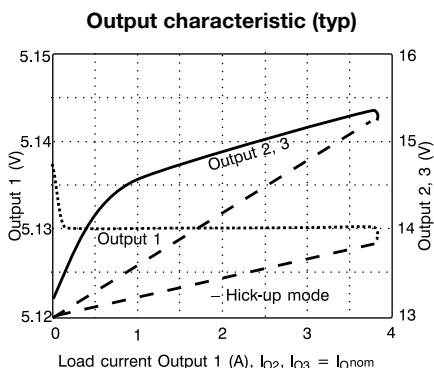
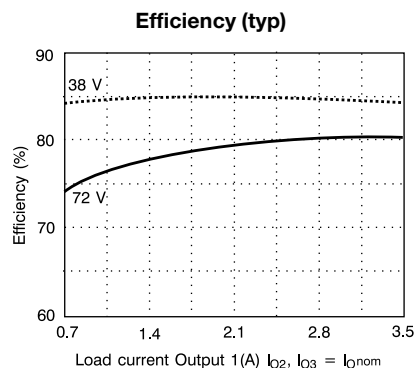

PKE 4235 PI

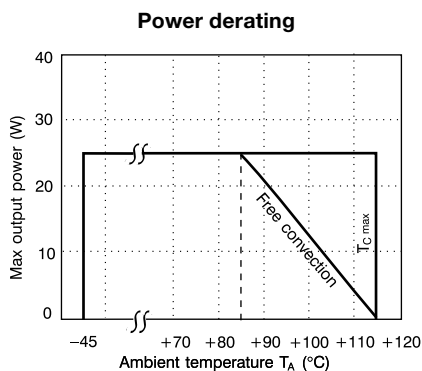
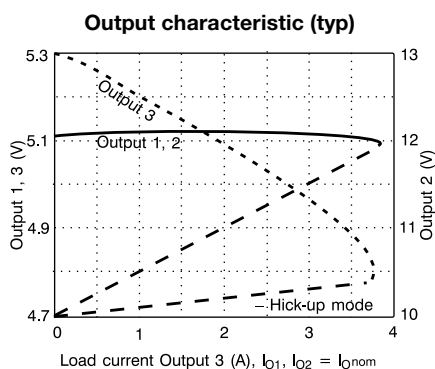
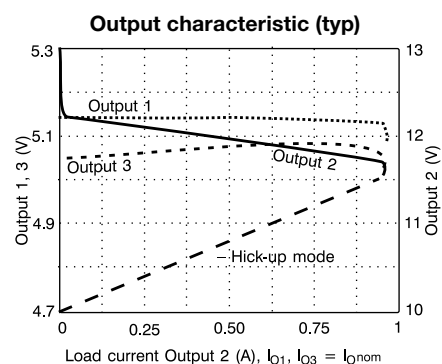
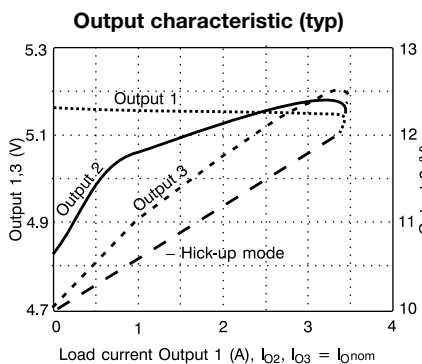
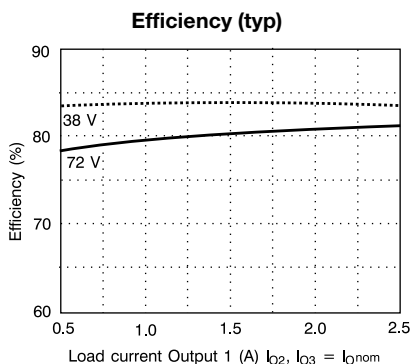

PKE 4431 PI

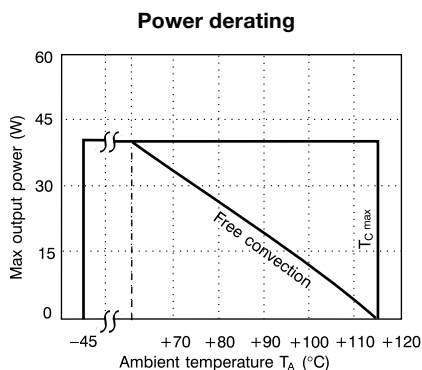
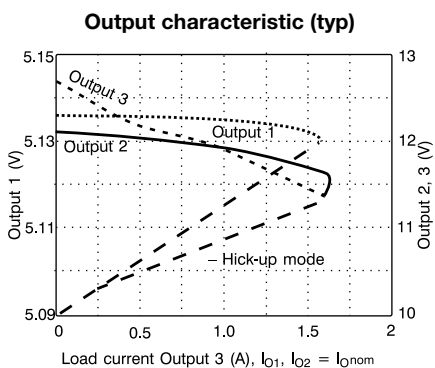
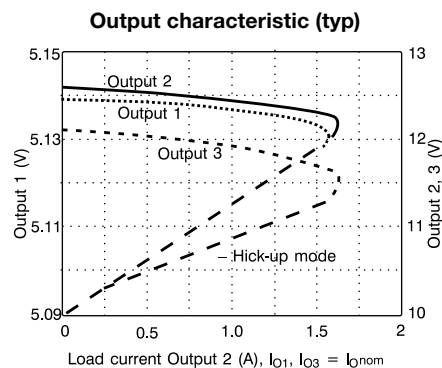
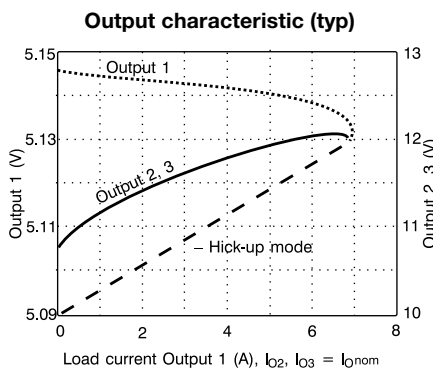
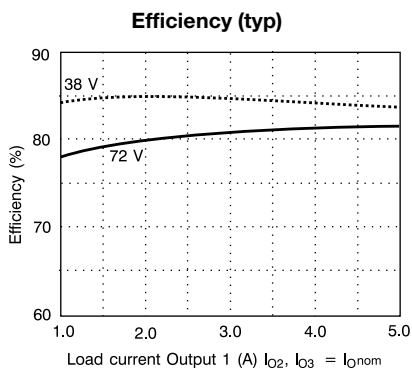

EMC Specifications

The conducted EMI measurement was performed using a module placed directly on the test bench.

The fundamental switching frequency is $300 \text{ kHz} \pm 15\%$ @ $V_I = 50\text{V}$, $I_O = (0.1 \dots 1.0) \times I_{Omax}$.

Conducted EMI Input terminal value (typ)

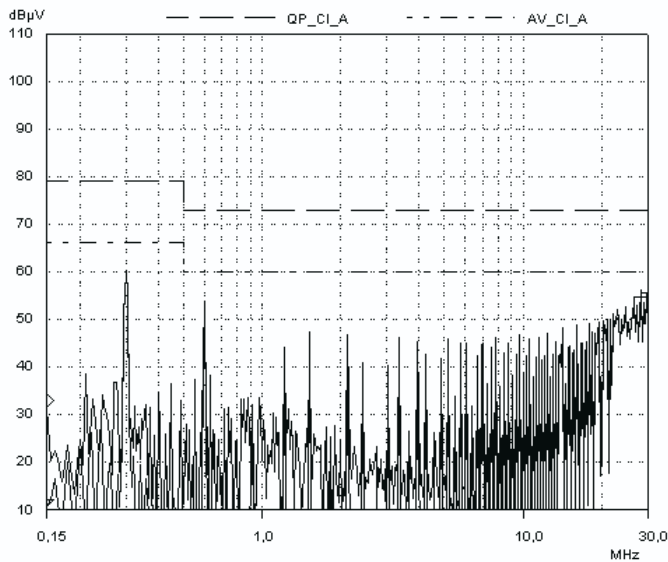

Test Set-up according to CISPR publ. 1A.

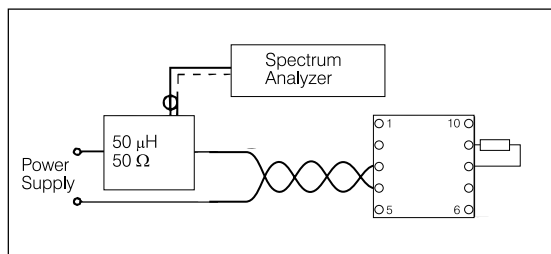

Radiated EMI

To minimize radiation it is recommended to connect the case to ground with pin 2 and use a good layout.

Output Ripple (V_{Oac})

Output ripple is measured as the peak to peak voltage of the fundamental switching frequency.

Operating information

Remote Control (RC)

Turn-on or turn-off can be realized by using the RC-pin. Normal operation is achieved if pin 1 is open (NC). If pin 1 is connected to pin 4 the PKE DC/DC power module turns off. To ensure safe turn-off the voltage difference between pin 1 and 4 shall be less than 1.8 V. RC is TTL open collector compatible (see fig. 1). Pin 1 is an output and no current should be driven into pin 1. Use a diode if necessary e.g. totem pole TTL logic. The internal pull-up resistance is $36 \text{ k}\Omega$.

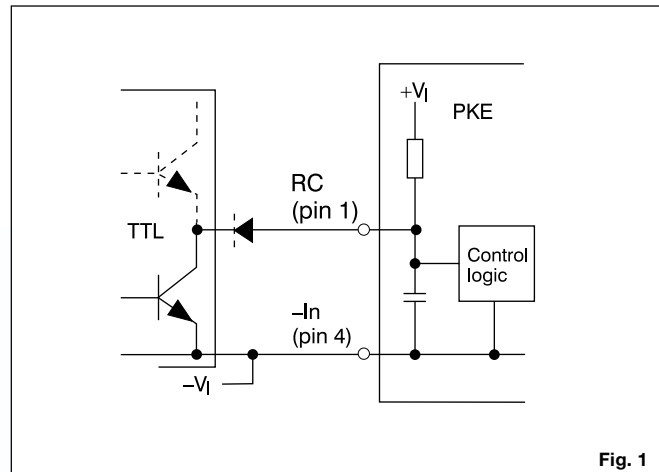

Fig. 1

Over Voltage Protection (OVP)

The remote control can also be utilized for OVP by using the external circuitry in fig. 2. Resistor values given are for 5 V output applications, but can easily be adjusted for other output voltages and the desired OVP level.

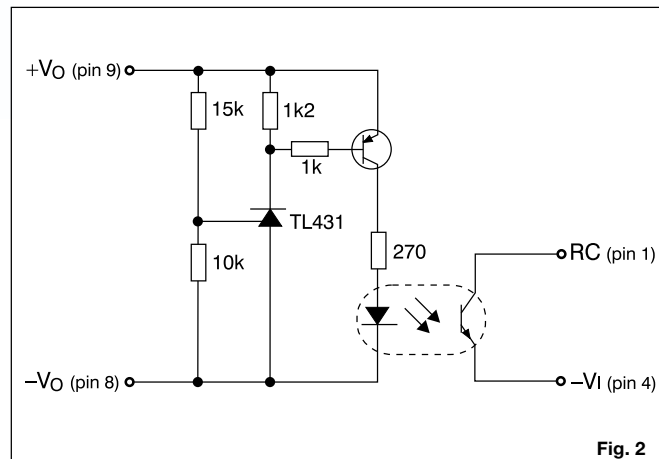

Fig. 2

Maximum Capacitive Load

The maximum recommended capacitance connected directly to the PKE DC/DC power modules' output, without resistance or inductance in series, is $100 \mu\text{F}/\text{A}$ (output current rating). Connect capacitors across the load for maximum effectiveness and maximum stability margins.

Turn-off Input Voltage (V_{Ioff})

The input voltage is monitored and the PKE DC/DC power module will turn on and turn off at predetermined levels. The levels can be decreased by means of an external resistor connected between pin 1 and pin 3. A $200 \text{ k}\Omega$ resistor will decrease the shutdown voltage below 35 V. To maintain the nominal output voltage at input voltages below V_{Imin} it may be necessary to decrease the load.

Output Voltage Adjust (V_{adj})

The output voltage, V_O , can be adjusted by using an external resistor. The output voltage adjust function is not accurate and it is recommended to use a potentiometer. To decrease the output

voltage the resistor should be connected between pin 10 and pin 9 (+ Out 1). To increase the output voltage the resistor should be connected between pin 10 and pin 8 (–Out 1).

Thermal Resistance

Thermal resistance case to ambient is 5.5 °C/W.

Parallel Operation

Due to the current limiting protection (hick-up), temperature coefficient and output voltage characteristic for PKE paralleling of modules for increased power is not recommended. PKE can be paralleled for redundancy.

Current Limiting Protection

The output power is limited at loads above the output current limiting threshold (I_{lim}), specified as a minimum value. As the PKE multiple output models are power limited, current limiting threshold for an individual output is set by the loads on the other outputs. The power module can withstand continuous short circuit without destruction. A hick-up mode is used on all models to minimize the internal power dissipation. The hick-up time constant is set by the slow start.

Input and Output Impedance

Both the source impedance of the power feeding and the load impedance will interact with the impedance of the DC/DC power module.

It is most important to have the ratio between L and C as low as possible, i.e. a low characteristic impedance, both at the input and output, as the power modules have a low energy storage capability.

Use an electrolytic capacitor across the input or output if the source or load inductance is larger than 10 µH. Their equivalent series resistance together with the capacitance acts as a lossless damping filter. Suitable capacitor values are in the range 10–100 µF.

Quality

Reliability

Meantime between failure (MTBF) is calculated to >2.0 million hours at full output power and a case temperature of +75°C ($T_A = +45^\circ\text{C}$), using the Ericsson failure rate data system. The Ericsson failure rate data system is based on field failure rates and is continuously updated.

The data corresponds to actual failure rates of component used in Information Technology and Telecom equipment in temperature controlled environments ($T_A = -5 \dots +65^\circ\text{C}$). The data is considered to have a confidence level of 90%. For more information see Design Note 002.

Quality Statement

The products are designed and manufactured in an industrial environment where quality systems and methods like ISO 9000, 6σ and SPC, are intensively in use to boost the continuous im-

provements strategy. Infant mortality or early failures in the products are screened out by a burn-in procedure and an ATE-based final test.

Conservative design rules, design reviews and product qualifications, plus the high competence of an engaged work force, contribute to the high quality of our products.

Warranty

Ericsson Microelectronics warrants to the original purchaser or end user that the products conform to this Data Sheet and are free from material and workmanship defects for a period of five (5) years from the date of manufacture, if the product is used within specified conditions and not opened. In case the product is discontinued, claims will be accepted up to three (3) years from the date of the discontinuation.

For additional details on this limited warranty we refer to Ericsson Microelectronics AB's "General Terms and Conditions of Sales", or individual contract documents.

Limitation of Liability

Ericsson Microelectronics does not make any other warranties, expressed or implied including any warranty of merchantability or fitness for a particular purpose (including, but not limited to, use in life support applications, where malfunctions of product can cause injury to a person's health or life).

Information given in this data sheet is believed to be accurate and reliable. No responsibility is assumed for the consequences of its use nor for any infringement of patents or other rights of third parties which may result from its use. No license is granted by implication or otherwise under any patent or patent rights of Ericsson Microelectronics. These products are sold only according to Ericsson Microelectronics' general conditions of sale, unless otherwise confirmed in writing. Specifications subject to change without notice.

Product Program

V _I	V _O /I _O max			P _O max	Ordering No.
	Output 1	Output 2	Output 3		
48/60 V	3.3 V/7.6 A			25 W	PKE 4210 PI
	5 V/5 A			25 W	PKE 4211 PI
	5 V/8 A			40 W	PKE 4411 PI
	12 V/2 A	12 V/2 A		30 W	PKE 4323 PI
	15 V/1.6 A	15 V/1.6 A		30 W	PKE 4325 PI
	+5 V/5 A	+12 V/1 A	-12 V/1 A	25 W	PKE 4231 PI
	+5 V/5 A	+15 V/0.8A	-15 V/0.8 A	25 W	PKE 4232 PI
	+5 V/5 A	+12 V/1 A	-5 V/3 A	25 W	PKE 4235 PI
	+5 V/7 A	+12 V/2 A	-12 V/2 A	40 W	PKE 4431 PI

Ericsson Microelectronics AB

SE-164 81 KISTA, Sweden

Phone: +46 8 757 5000

www.ericsson.com/microelectronics

For local sales contacts, please refer to our website
or call: Int. +46 8 757 4700, Fax: +46 8 757 4776

The latest and most complete information can be found on our website!

Data Sheet

EN/LZT 146 26 R1A (Replaces EN/LZT 137 31 R1)

© Ericsson Microelectronics AB, June 2000