

40A DC/DC Power Modules

48V Input Series; 1.8V, 2.5V and 3.3V Outputs

- High efficiency 92% Typ at full load
- High power density, 48.2 W/in³, (3.3V @ 40A)
- Fast dynamic response, 200 μ s, \pm 200 mVpeak Typ
- Low output ripple, 80 mVp-p Typ
- Parallelable with no external components
- Wide input voltage range (36-75V)
- 1,500Vdc isolation voltage
- Max case temperature +100°C
- UL 1950/UL_C Recognized
- TUV 60 950 Type Approved



The PKJ 4000B series represents another one of Ericsson's "industry first" achievements in the continued development of our "Third Generation" of high-density, high-efficiency power modules. This module packs 48.2 W/in³ at 92% efficiencies (3.3V @ 40A) in an industry standard half-brick package. These breakthrough features come from using the most advanced patented topology utilizing integrated magnetics and synchronous rectification on a low-resistivity multilayer PCB.

This product features fast dynamic response times and low output ripple, which are important parameters when supplying low-voltage logics. The PKJ 4000B series also is especially suited for limited board space and high dynamic load applications.

Ericsson's PKJ 4000B Power Module has been designed with the converging "New Telecoms" market in mind, by specifying the input voltage range in accordance with ETSI specifications. The PKJ 4000B series also offers over-voltage protection, under-voltage protection, over-temperature protection, soft-start, and is short circuit proof.

These modules are manufactured on highly automated manufacturing lines. Ericsson's world-class quality commitment is reflected in our standard five-year warranty. Ericsson Inc., Microelectronics has been an ISO 9001 certified supplier since 1991.

For a complete product program, please reference the back page.



General

Absolute Maximum Ratings

Characteristics		min	max	Unit
T _C	Maximum Operating Case Temperature	-40	+100	°C
T _S	Storage temperature	-40	+125	°C
V _I	Continuous input voltage	-0.5	+80	Vdc
V _{ISO}	Isolation voltage (input to output test voltage)	1,500		Vdc
V _{RC}	Remote control voltage		12	Vdc
I ² t	Inrush transient		1	A ² s

Stress in excess of Absolute Maximum Ratings may cause permanent damage. Absolute Maximum Ratings, sometimes referred to as no destruction limits, are normally tested with one parameter at a time exceeding the limits of Output Data or Electrical Characteristics.

If exposed to stress above these limits, function and performance may degrade in an unspecified manner. For design margin and to enhance system reliability, it is recommended that the PKJ 4000B series DC/DC power modules are operated at case temperatures below 90°C.

Input T_C < T_{Cmax}

Characteristics		Conditions		min	typ	max	Unit
V _I	Input voltage range ¹⁾			36	75		Vdc
V _{Ioff}	Turn-off input voltage	Ramping from higher voltage		31	33		Vdc
V _{Ion}	Turn-on input voltage	Ramping from lower voltage			34	36	Vdc
C _I	Input capacitance				3.5		µF
I _{lac}	Reflected ripple current	5 Hz to 20 MHz					mA p-p
I _{Imax}	Maximum input current	V _I = V _{I min}	72W 100W 132W		2.3 3.2 4.2		A
P _{II}	Input idling power	I _O = 0			6		W
P _{RC}	Input stand-by power (turned off with RC)	V _I = 50V	RC open		0.4	0.6	W
VTRIM	Maximum input voltage on trim pin					6	Vdc

1) See also Input Voltage in the Operating Information section

Safety

The PKJ 4000B Series DC/DC power modules are designed to comply with EN 60 950 Safety of information technology equipment including electrical business equipment and are TUV Type Approved.

The PKJ 4000B DC/DC power modules are also recognized by UL and meet the applicable requirements in UL 1950, Safety of information technology equipment and applicable Canadian safety requirements, i.e. ULc 1950.

The isolation is an operational insulation in accordance with EN 60 950. The DC/DC power module should be installed in end-use equipment, in compliance with the requirements of the ultimate application, and is intended to be supplied by an isolated secondary circuit. Consideration should be given to measuring the case temperature to comply with T_{Cmax} when in operation.

When the supply to the DC/DC power module meets all the requirements for SELV (<60Vdc), the output is considered to remain within SELV limits (level 3). If connected to a 60V DC power system, reinforced insulation must be provided in the power supply that isolates the input from the mains. Single fault testing in the power supply must be performed in combination with the DC/DC power module to demonstrate that the output meets the requirement for SELV. One pole of the input and one pole of the output is to be grounded or both are to be kept floating.

Environmental Characteristics

Characteristics	Test procedure & conditions		
Random Vibration	IEC 68-2-34F _C	Frequency Spectral density Duration	10...500 Hz 0.025 g ² /Hz 10 min in each direction
Sinusoidal Vibration	IEC 68-2-6 F _C	Frequency Amplitude Acceleration # of cycles	10-500 Hz 0.75mm 10g 10 in each axis
Shock (half sinus)	IEC 68-2-27 E _a	Peak acceleration Duration	100 g 3ms
Temperature change	IEC 68-2-14 N _a	Temperature Number of cycles	-40°C...+100°C 300
Accelerated damp heat	IEC 68-2-3 C _a with bias	Temperature Humidity Duration	85°C 85% RH 1000 hours
Solder resistibility	IEC 68-2-20 T _b method IA	Temperature, solder Duration	260° C 10...13 s

Safety (continued)

The galvanic isolation is verified in an electric strength test. The test voltage (V_{ISO}) between input and output is 1,500 Vdc for 60 sec. Leakage current is less than $1\mu A$ @ 50Vdc.

Flammability ratings of the terminal support and internal plastic construction details meet UL 94V-0.

A fuse should be used at the input of each PKJ 4000B series power module. If a fault occurs in the power module, that imposes a short on the input source, this fuse will provide the following two

functions:

- Isolate the failed module from the input source so that the remainder of the system may continue operation.
- Protect the distribution wiring from overheating.

A fast blow fuse should be used with a rating of 20A or less. It is recommended to use a fuse with the lowest current rating, that is suitable for the application.

Mechanical Data

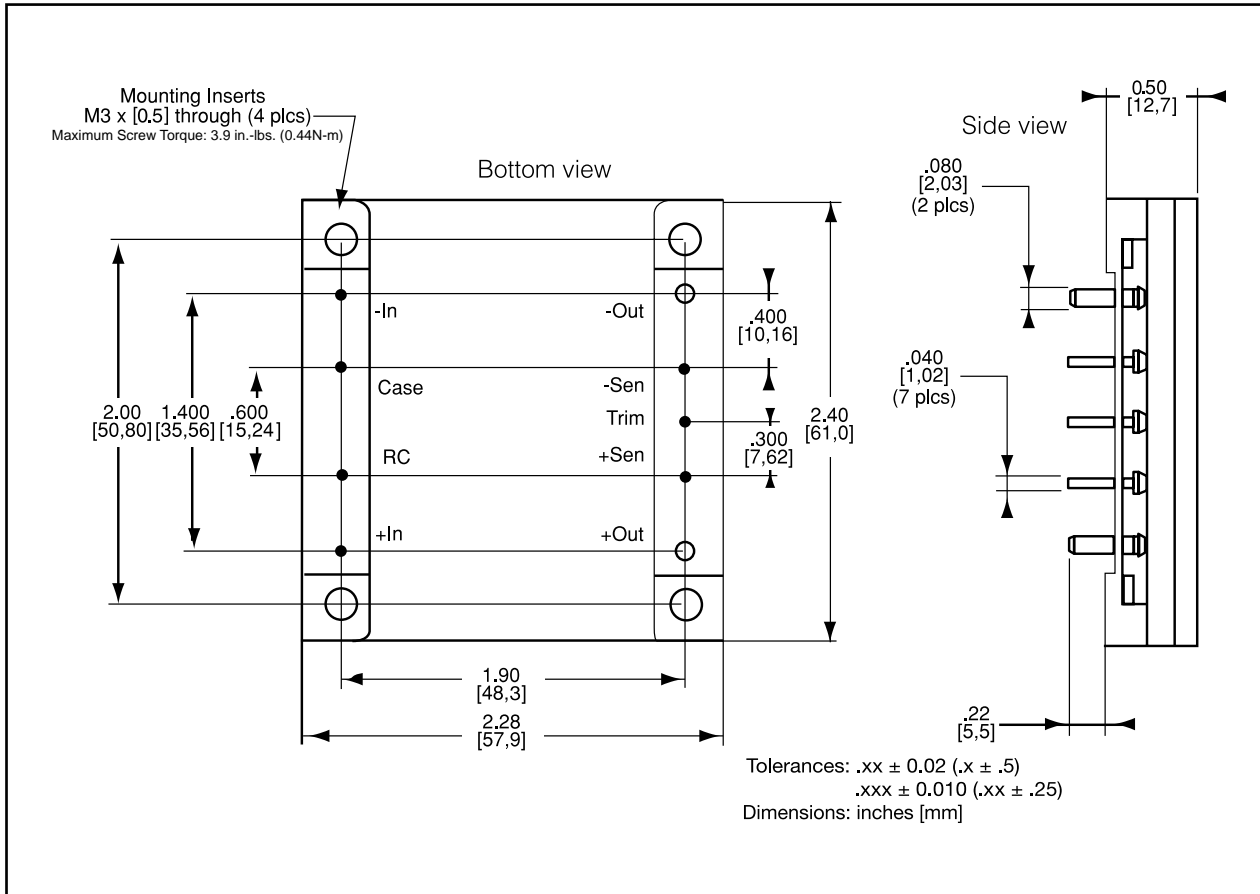

Connections

Designation	Function	Pin # (for Ref.)
-IN	Negative input	1
CASE	Connected to base plate	2
RC	Remote control (primary). To turn-on and turn-off the output	3
+IN	Positive input	4
-OUT	Negative output	5
-SEN	Negative remote sense	6
TRIM	Output voltage adjust	7
+SEN	Positive remote sense	8
+OUT	Positive output	9

Weight

80 grams

Case

Aluminum baseplate with metal standoffs

Pins

Pin material: Brass

Pin plating: Tin/Lead over Nickel

Thermal Data

The PKJ 4000B series DC/DC power modules have a robust thermal design that allows operation at case (baseplate) temperatures (T_c) up to $+100^\circ\text{C}$. The Output Derating Curves are based on an Input Voltage of 53V.

The graphs below show the allowable maximum output current to maintain a maximum $+100^\circ\text{C}$ case temperature. Note that the ambient temperature is the air temperature adjacent to the power module which is typically elevated above the room environmental temperature.

Airflow Conversion Table	
m/s	lfm
0.5	100
1.0	200
1.5	300
2.0	400
2.5	500
3.0	600

Note: Natural Convection average airflow speed can vary from 0.05 m/s to 0.2 m/s.

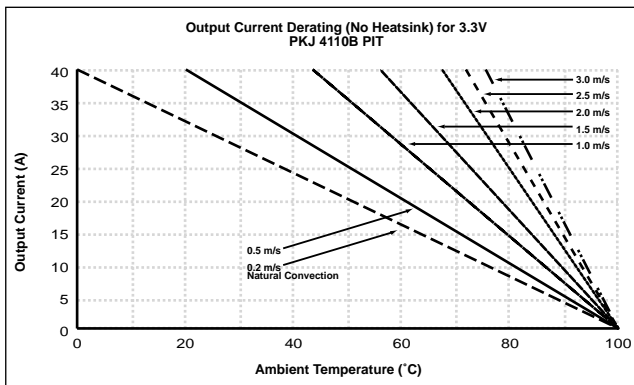
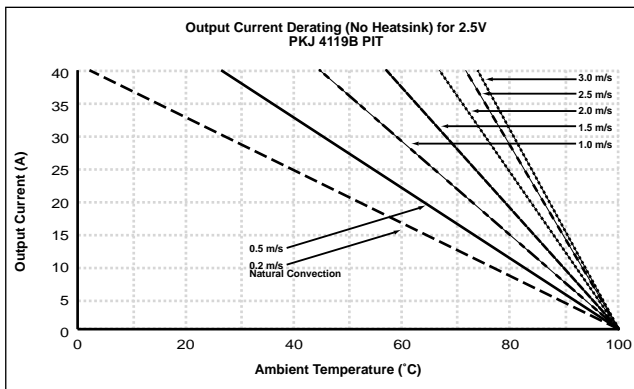
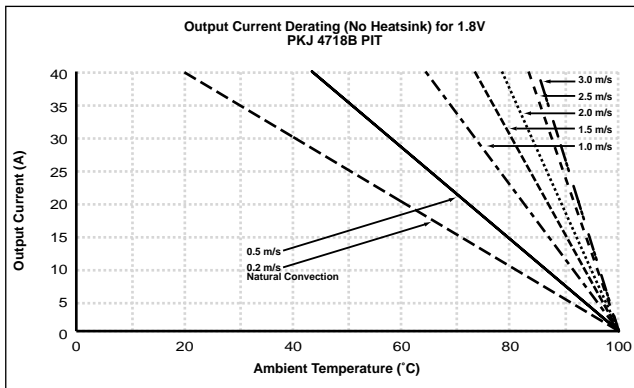

The graphs below can be used to estimate case temperatures for given system operating conditions (see Thermal Design). For further information on optional heatsinks, please contact your local Ericsson sales office.

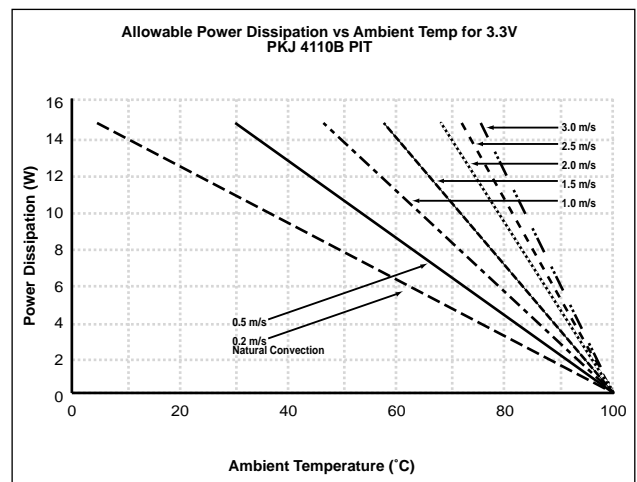
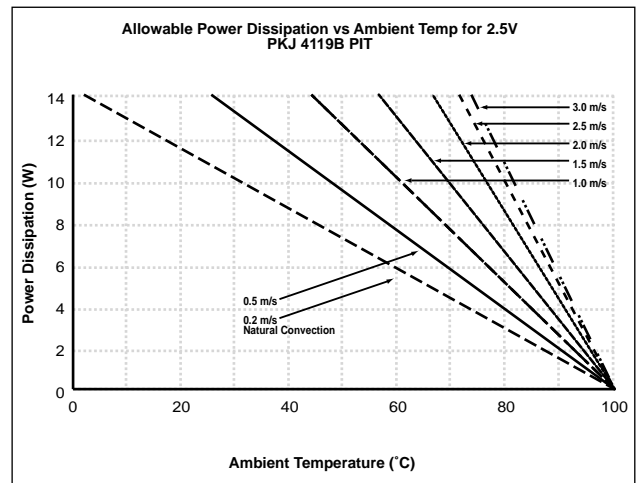
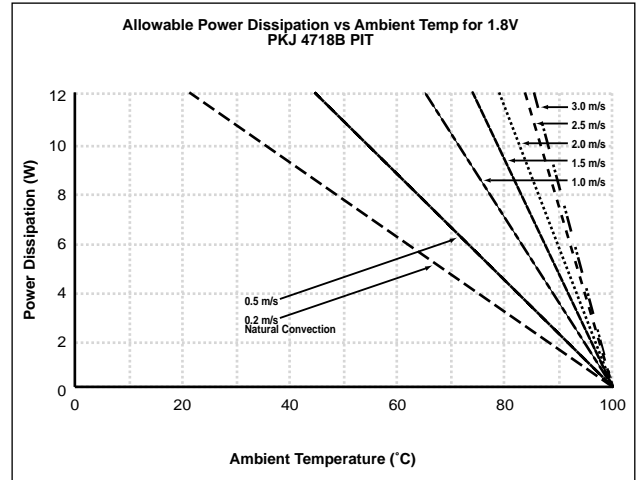

Thermal Design

The thermal data can be used to determine thermal performance without a heatsink.

Case temperature is calculated by the following formula:

$$T_C = T_A + P_d \times R_{thC-A} \text{ where } P_d = P_O(1/\eta - 1)$$

Where:

T_C : Case Temperature

T_A : Local Ambient Temperature

P_d : Dissipated Power

R_{thC-A} : Thermal Resistance from T_C to T_A

The efficiency η can be found in the tables on the following pages.

For design margin and to enhance system reliability, it is recommended that the PKJ 4000B series DC/DC power modules be operated at case temperatures below 90°C.

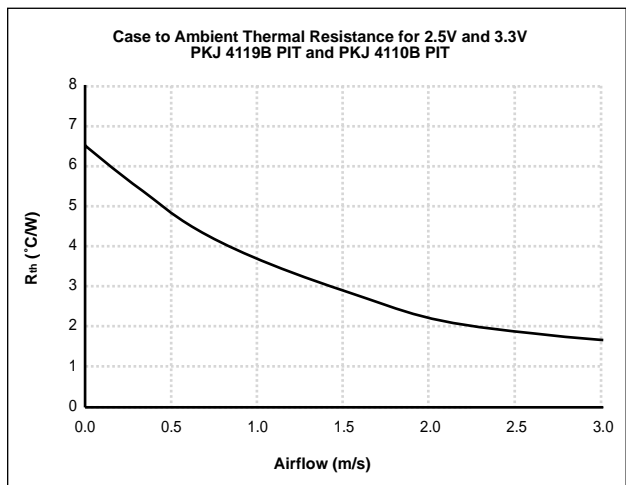
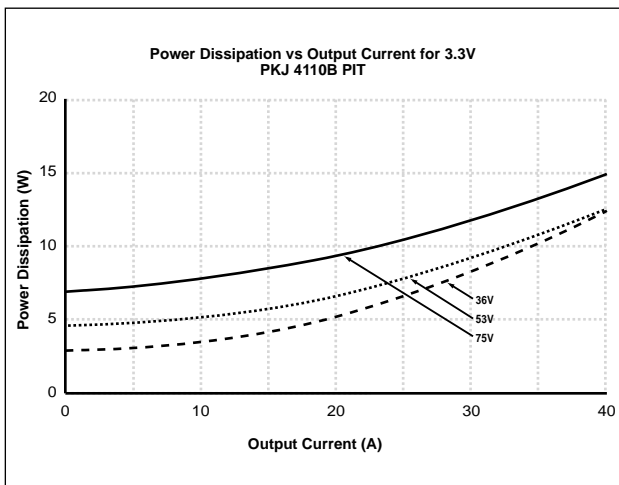
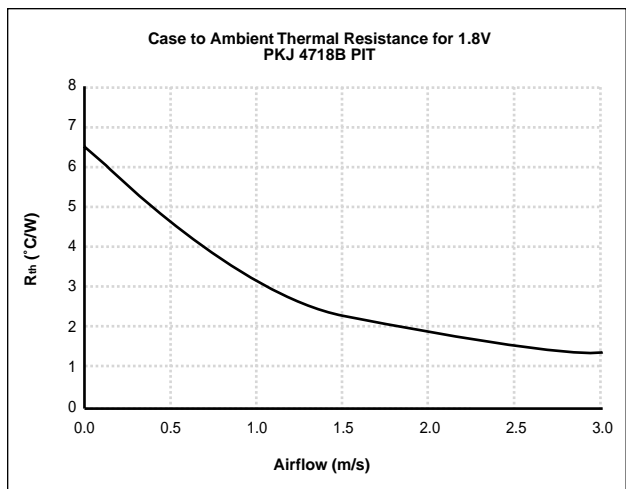
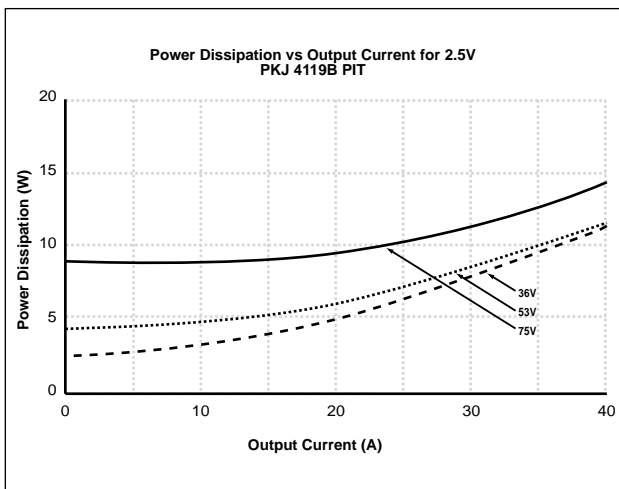
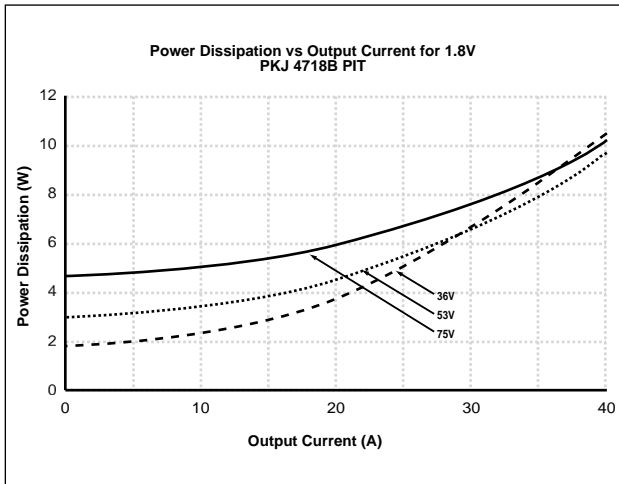

PKJ 4718B PIT (72W)

$T_C = -40...+100^{\circ}\text{C}$, $V_I = 36...75\text{ V dc}$ unless otherwise specified.

Output

Characteristics		Conditions		Output			Unit
				min	typ	max	
V_{O_i}	Output voltage initial setting and accuracy	$T_C = +25^{\circ}\text{C}$, $V_I = 53\text{V}$, $I_O = I_{Omax}$		1.77	1.8	1.83	V
	Output adjust range	$I_O = 0$ to I_{Omax}		1.44		2.0	V
V_O	Output voltage tolerance band	$I_O = 0$ to I_{Omax}		1.71		1.89	V
	Line regulation	$I_O = I_{Omax}$			5	15	mV
	Load regulation	$V_I = 53\text{V}$, $I_O = 0$ to I_{Omax}			5	15	mV
V_{tr}	Load transient voltage deviation	Load step = $0.25 \times I_{Omax}$ $di/dt = 1\text{A}/\mu\text{s}$		± 200			mVpeak
t_{tr}	Load transient recovery time			200			μs
t_s	Start-up time	From V_I connection to $V_O = 0.9 \times V_{Onom}$			20	30	ms
I_O	Output current			0		40	A
P_{Omax}	Max output power	At $V_O = V_{Onom}$				72	W
I_{lim}	Current limit threshold	$V_O = 0.90 \times V_{Onom}$ @ $T_C < 100^{\circ}\text{C}$		41	46	51	A
I_{SC}	Short circuit current				50	55	A
V_{Oac}	Output ripple and noise	$I_O = I_{Omax}$	$f < 20\text{ MHz}$		80	150	mVp-p
SVR	Supply voltage rejection (ac)	$f < 1\text{ kHz}$		-50			dB
OVP	Over voltage protection	$V_I = 53\text{V}$		2.2	2.5	2.9	V

Miscellaneous

Characteristics		Conditions		min	typ	max	Unit
η	Efficiency	$T_A = +25^{\circ}\text{C}$, $V_I = 53\text{V}$, $I_O = I_{Omax}$			89		%
P_d	Power dissipation	$T_A = +25^{\circ}\text{C}$, $V_I = 53\text{V}$, $I_O = I_{Omax}$			8.9		W
f_O	Switching frequency	$I_O = 0.1...1.0 \times I_{Omax}$			150		kHz

PKJ 4119B PIT (100W)

$T_C = -40...+100^{\circ}\text{C}$, $V_I = 36...75\text{ V}$ dc unless otherwise specified.

Output

Characteristics		Conditions		Output			Unit
				min	typ	max	
V_{O_i}	Output voltage initial setting and accuracy	$T_C = +25^{\circ}\text{C}$, $V_I = 53\text{V}$, $I_O = I_{Omax}$		2.45	2.5	2.55	V
	Output adjust range	$I_O = 0$ to I_{Omax}		2.0		2.75	V
V_O	Output voltage tolerance band	$I_O = 0$ to I_{Omax}		2.38		2.63	V
	Line regulation	$I_O = 0$ to I_{Omax}			5	15	mV
	Load regulation	$V_I = 53\text{V}$, $I_O = 0$ to I_{Omax}			5	15	mV
V_{tr}	Load transient voltage deviation	Load step = $0.25 \times I_{Omax}$ $di/dt = 1\text{A}/\mu\text{s}$		± 200			mVpeak
t_{tr}	Load transient recovery time			200			μs
t_s	Start-up time	From V_I connection to $V_O = 0.9 \times V_{Onom}$		20	30		ms
I_O	Output current			0		40	A
P_{Omax}	Max output power	At $V_O = V_{Onom}$		100			W
I_{lim}	Current limit threshold	$V_O = 0.90 \times V_{Onom}$ @ $T_C < 100^{\circ}\text{C}$		41	46	51	A
I_{SC}	Short circuit current				50	55	A
V_{Oac}	Output ripple and noise	$I_O = I_{Omax}$	$f < 20\text{ MHz}$		80	150	mVp-p
SVR	Supply voltage rejection	$f < 1\text{ kHz}$		-50			dB
OVP	Overvoltage protection			3.0	3.3	3.9	V

Miscellaneous

Characteristics		Conditions		min	typ	max	Unit
η	Efficiency	$T_A = +25^{\circ}\text{C}$, $V_I = 53\text{V}$, $I_O = I_{Omax}$			90		%
P_d	Power dissipation	$T_A = +25^{\circ}\text{C}$, $V_I = 53\text{V}$, $I_O = I_{Omax}$			11.1		W
f_O	Switching frequency	$I_O = 0.1...1.0 \times I_{Omax}$			150		kHz

PKJ 4110B PIT (132W)

$T_C = -40...+100^{\circ}\text{C}$, $V_I = 36...75\text{ V}$ dc unless otherwise specified.

Output

Characteristics		Conditions		Output			Unit
				min	typ	max	
V_{oi}	Output voltage initial setting and accuracy	$T_C = +25^{\circ}\text{C}$, $V_I = 53\text{V}$, $I_O = I_{Omax}$		3.25	3.3	3.35	V
	Output adjust range	$I_O = 0$ to I_{Omax}		2.64		3.63	V
V_O	Output voltage tolerance band	$I_O = 0$ to I_{Omax}		3.2		3.4	V
	Line regulation	$I_O = I_{Omax}$			5	15	mV
	Load regulation	$V_I = 53\text{V}$, $I_O = 0$ to I_{Omax}			5	15	mV
V_{tr}	Load transient voltage deviation	Load step = $0.25 \times I_{Omax}$ $di/dt = 1\text{A}/\mu\text{s}$			± 200		mVpeak
t_{tr}	Load transient recovery time				200		μs
t_s	Start-up time	From V_I connection to $V_O = 0.9 \times V_{Onom}$			20	30	ms
I_O	Output current			0		40	A
P_{Omax}	Max output power	At $V_O = V_{Onom}$				132	W
I_{lim}	Current limit threshold	$V_O = 0.90 \times V_{Onom}$ @ $T_C < 100^{\circ}\text{C}$		41	46	51	A
I_{sc}	Short circuit current				50	55	A
V_{Oac}	Output ripple and noise	$I_O = I_{Omax}$	$f < 20\text{ MHz}$		80	150	mVp-p
SVR	Supply voltage rejection	$f < 1\text{ kHz}$		-50			dB
OVP	Overvoltage protection			3.9	4.4	5.0	V

Miscellaneous

Characteristics		Conditions		min	typ	max	Unit
η	Efficiency	$T_A = +25^{\circ}\text{C}$, $V_I = 53\text{V}$, $I_O = I_{Omax}$			92		%
P_d	Power dissipation	$T_A = +25^{\circ}\text{C}$, $V_I = 53\text{V}$, $I_O = I_{Omax}$			11.5		W
f_o	Switching frequency	$I_O = 0.1...1.0 \times I_{Omax}$			150		kHz

Typical Characteristics

PKJ 4718B PIT (72W)

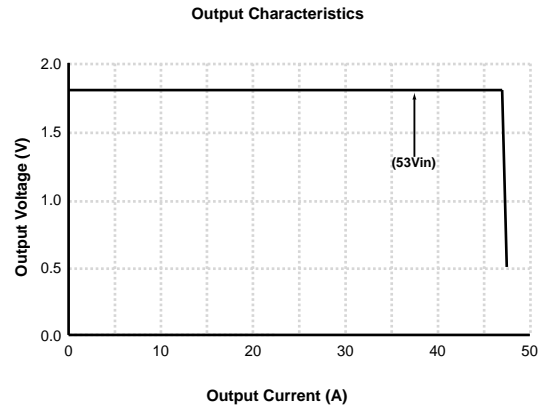
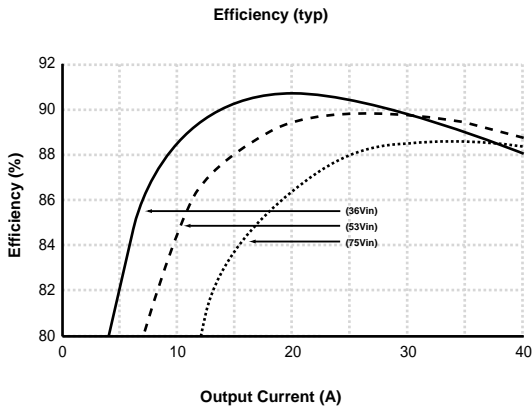

PKJ 4119B PIT (100W)

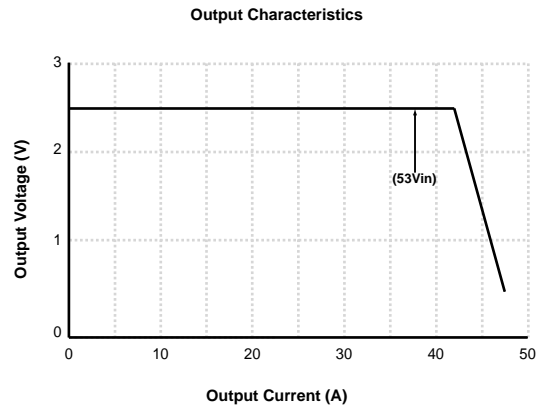
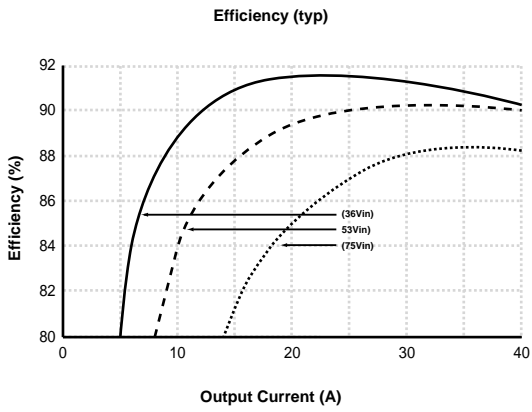

PKJ 4110B PIT (132W)

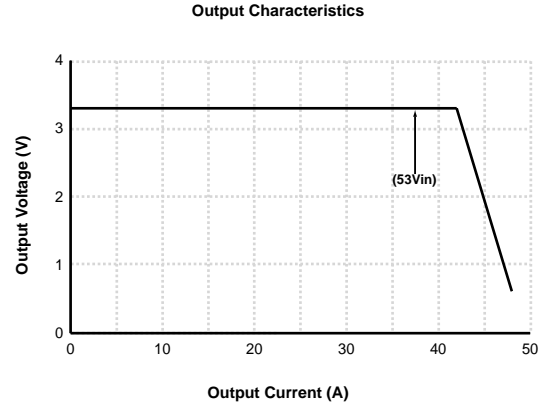
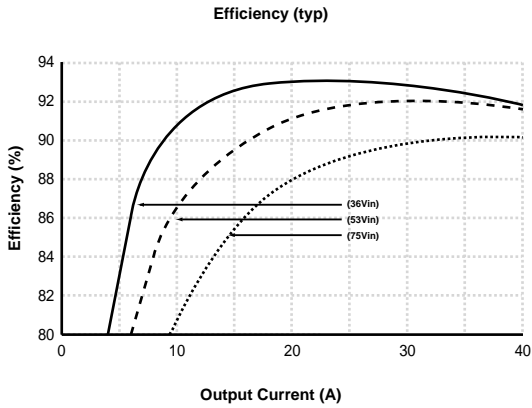

EMC Specifications

The PKJ 4000B power module is mounted on a double-sided printed circuit board PCB with groundplane during EMC measurements.

The fundamental switching frequency is 150 kHz @ $I_O = I_{Omax}$.

Conducted EMI

Input terminal value with 100µF capacitor (typ) and additional PI filter.

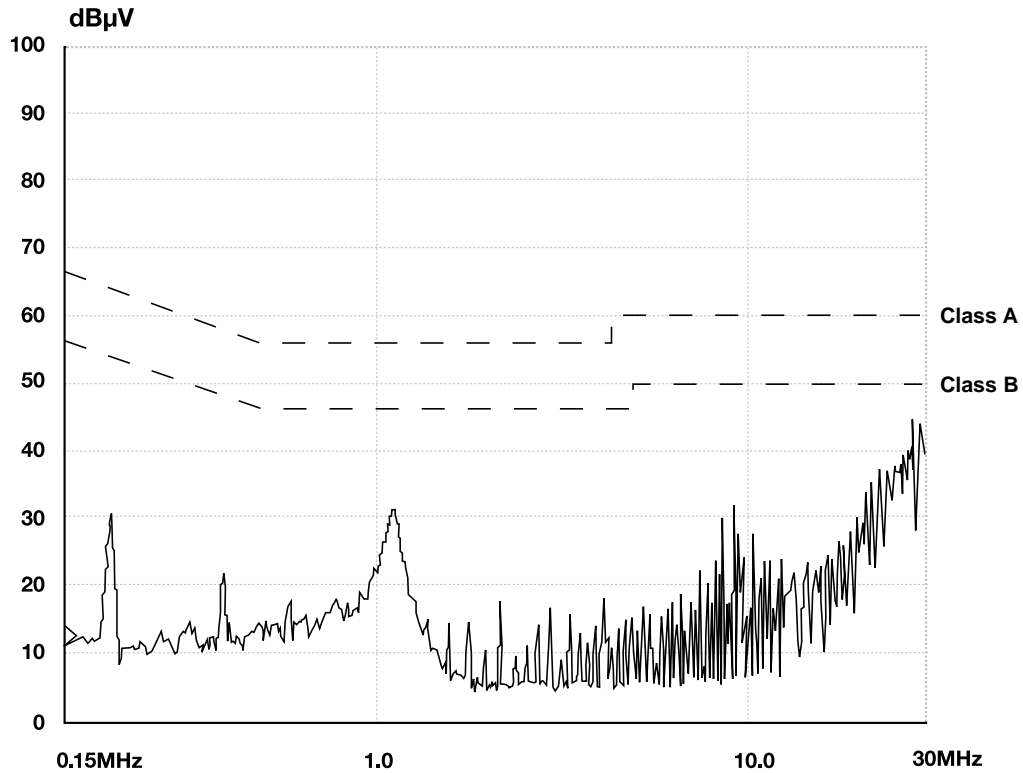

External Filter (class B)

Required external input filter in order to meet class B in EN55022, CISPR 22 and FCC part 15J.

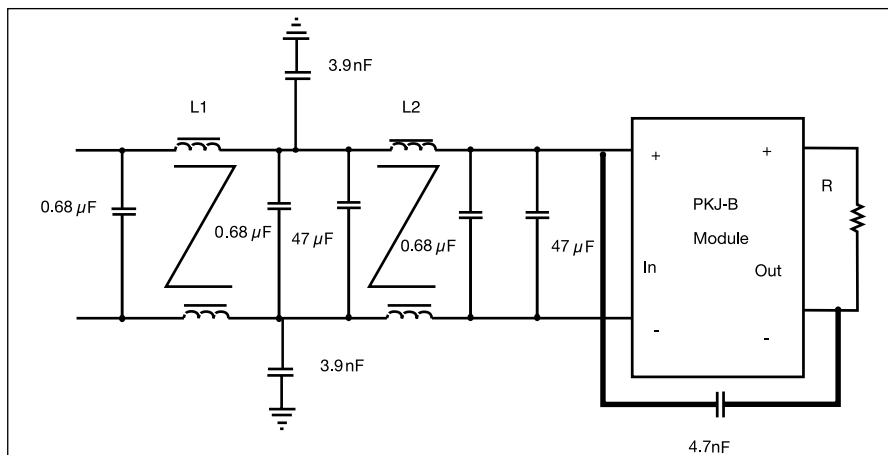

L1=L2=574µH

Operating Information

Input Voltage

The input voltage range 36...75V meets the requirements in the European Telecom Standard ETS 300 132-2 for normal input voltage range in -48V and -60V DC power systems, -40.5...-57.0V and -50.0...-72.0V respectively. At input voltages exceeding 75V, the power loss will be higher than at normal input voltage and T_C must be limited to absolute max +90° C. The absolute max continuous input voltage is 80V DC.

Remote Control (RC)

The PKJ 4000B series DC/DC power modules have two remote on/off options available. Negative logic remote on/off is the standard option orderable without a suffix added to the part number. Negative logic remote on/off turns the module off during a logic high voltage on the on/off pin, and on during a logic low state. Positive logic remote on/off is orderable by adding the suffix "P" to the end of the part number. Positive logic remote on/off turns the module on during a logic high and off during a logic low state.

The RC pin can be wired directly to -In, to allow the module to power up automatically without the need for control signals.

A mechanical switch or an open collector transistor or FET can be used to drive the RC inputs. The device must be capable of sinking up to 1mA at a low level voltage of 1.0V, maximum of 15V dc, for the primary RC.

Standard Remote Control		Optional Remote Control P	
RC (primary)	Power module	RC (primary)	Power module
Low	ON	Low	OFF
Open/High	OFF	Open/High	ON

Remote Sense

All PKJ 4000B series DC/DC power modules have remote sense that can be used to compensate for moderate amounts of resistance in the distribution system and allow for voltage regulation at the load or other selected point. The remote sense lines will carry very little current and do not need a large cross sectional area. However, the sense lines on a PCB should be located close to a ground trace or ground plane. In a discrete wiring situation, the usage of twisted pair wires or other technique for reducing noise susceptibility is recommended.

The power module will compensate for up to 0.5V voltage drop between the sense voltage and the voltage at the power module output pins. The output voltage and the remote sense voltage offset must be less than the minimum overvoltage trip point.

Current Limiting

General Characteristics

All PKJ 4000B series DC/DC power modules include current limiting circuitry that makes them able to withstand continuous overloads or short circuit conditions on the output. The output voltage will decrease toward zero for heavy overloads.

The power module will resume normal operation after removal of the overload. The load distribution system should be designed to carry the maximum short circuit output current specified.

Over Voltage Protection (OVP)

All PKJ 4000B DC/DC power modules have latching output overvoltage protection. In the event of an overvoltage condition, the power module will shut down. The power module can be restarted by cycling the input voltage.

Turn (on/off) Input Voltage (V_{Ion}/V_{Ioff})

The power module monitors the input voltage and will turn on and turn off at predetermined levels.

Output Voltage Adjust (Trim) Voltage Trimming

All PKJ 4000B series DC/DC power modules have an Output Voltage Adjust pin. This pin can be used to adjust the output voltage above or below V_{O_i} . When increasing the output voltage, the voltage at the output pins (including any remote sensing offset) must be kept below the overvoltage trip point. Also note that at elevated output voltages the maximum power rating of the module remains the same, and the output current capability will decrease correspondingly. These modules incorporate the same trim equation as used by some other major DC/DC converter suppliers.

These modules incorporate the same trim equation as used by some other major DC/DC converter suppliers.

To decrease V_O connect R_{adj} from - SEN to Trim

To increase V_O connect R_{adj} from + SEN to Trim

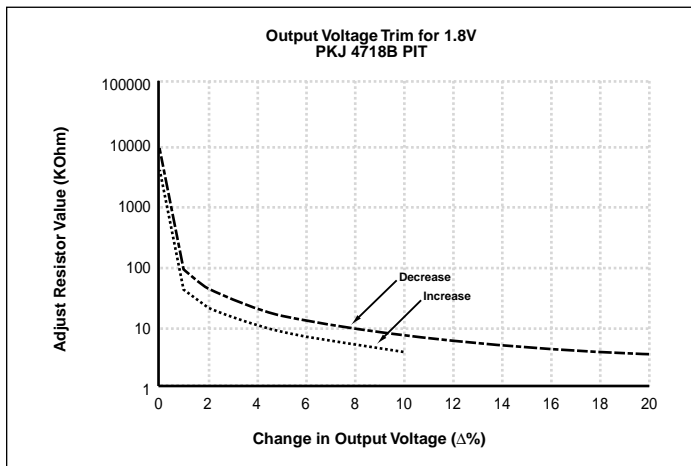

$$\text{Decrease: } R_{adj} = \left(\frac{100}{\Delta\%} - 2 \right) K\Omega$$

$$\text{Increase: } R_{adj} = \left[\frac{1.8(100+\Delta\%)}{1.225\Delta\%} - \frac{(100+2\Delta\%)}{\Delta\%} \right] K\Omega$$

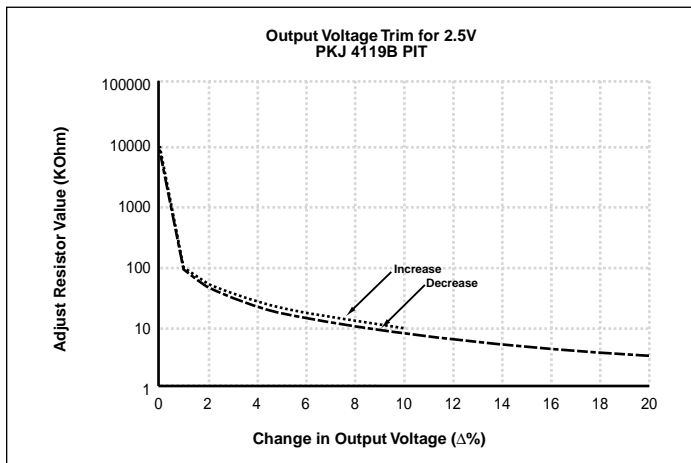

$$\text{Decrease: } R_{adj} = \left(\frac{100}{\Delta\%} - 2 \right) K\Omega$$

$$\text{Increase: } R_{adj} = \left[\frac{2.5(100+\Delta\%)}{1.225\Delta\%} - \frac{(100+2\Delta\%)}{\Delta\%} \right] K\Omega$$

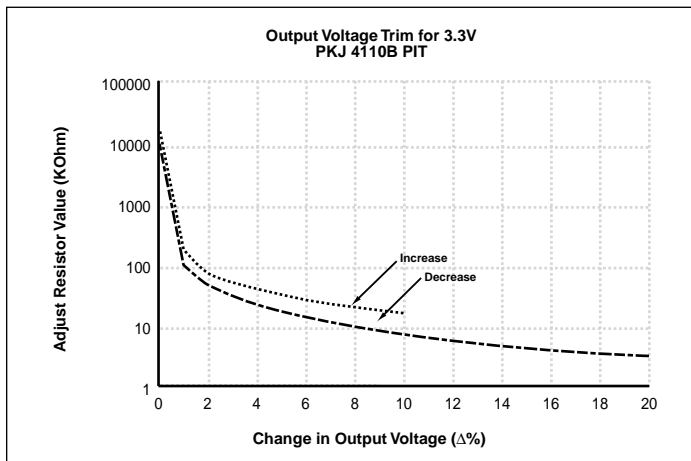

$$\text{Decrease: } R_{adj} = \left(\frac{100}{\Delta\%} - 2 \right) K\Omega$$

$$\text{Increase: } R_{adj} = \left[\frac{3.3(100+\Delta\%)}{1.225\Delta\%} - \frac{(100+2\Delta\%)}{\Delta\%} \right] K\Omega$$

Paralleling for Increased Power

The PKJ 4000B family of modules can be connected directly in parallel without any additional components. This is a new feature for a synchronous rectified type module. The PKJ 4000B family of converters utilizes a proprietary synchronous rectifier drive technique that prevents the modules from sinking current when connected in a parallel configuration. Furthermore, this unique drive allows a module to turn on into an established voltage (system voltage) without allowing its output inductor current to build in the negative direction. Finally, a timing circuit has been added to disable the synchronous rectifiers when a module is turned off through its on/off control.

Paralleling for Redundancy

Even though the PKJ 4000B family of modules is fully parallelable, the modules were not designed with a current share function. Therefore, if current sharing is required, an IC like the UC 3902 can be added externally to the module.

The figure below shows how a redundant $n+1$ system with current sharing can be implemented. Diodes D1 and D2 are added at the output of the dc-dc modules to allow for a failed module to remove itself from the system without causing a failure of the system voltage. This configuration can be extended to additional numbers of power modules. The DC-DC modules in this configuration can be controlled individually or in groups by means of the on/off control.

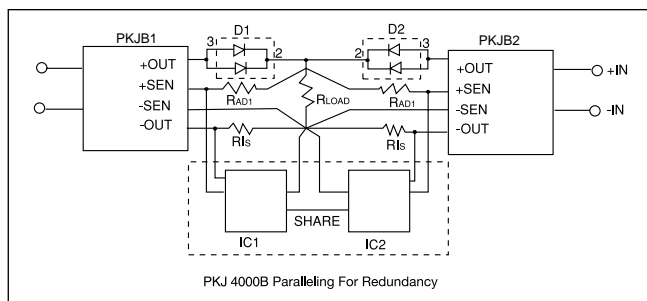

Output Ripple & Noise (V_{Oac})

Output ripple is measured as the peak to peak voltage from 0 to 20MHz which includes the noise voltage and fundamental ripple.

Over Temperature Protection

The PKJ 4000B DC/DC power modules are protected from thermal overload by an internal over temperature shutdown circuit. When the case temperature exceeds $+110^{\circ}\text{C}$ ($+10^{\circ}\text{C}$, -5°C), the power module will automatically shut down (latching). To restart the module the input voltage must be cycled.

Input and Output Impedance

The impedance of both the power source and the load will interact with the impedance of the DC/DC power module. It is most important to have the ratio between L and C as low as possible, i.e. a low characteristic impedance, both at the input and output, as the power modules have a low energy storage capability. The PKJ 4000B series of DC/DC power modules has been designed to be completely stable without the need for external capacitors on the input or output when configured with low inductance input and output circuits. The performance in some applications can be enhanced by the addition of external capacitance as described below. If the distribution of the input voltage source to the power module contains significant inductance, the addition of a 100-470 μF capacitor across the input of the power module will help insure stability. This capacitor is not required when powering the module from a low impedance source with short, low inductance, input power leads.

Output Capacitance

When powering loads with significant dynamic current requirements, the voltage regulation at the load can be improved by the addition of decoupling capacitance at the load. The most effective technique is to locate low ESR ceramic capacitors as close to the load as possible, using several capacitors to lower the effective ESR. These ceramic capacitors will handle the short duration high frequency components of the dynamic current requirement. In addition, higher values of electrolytic capacitors should be used to handle the mid-frequency components. It is equally important to use good design practices when configuring the DC distribution system.

Low resistance and low inductance PCB (printed circuit board) layouts and cabling should be used. Remember that when using remote sensing, all the resistance, inductance and capacitance of the distribution system is within the feedback loop of the power module. This can have an effect on the modules compensation and the resulting stability and dynamic response performance.

As a rule of thumb, 100 $\mu\text{F}/\text{A}$ of output current can be used without any additional analysis. For example, with a 40A (max P_o 132W) power module, values of decoupling capacitance up to 4000 μF can be used without regard to stability. With larger values of capacitance, the load transient recovery time can exceed the specified value. As much of the capacitance as possible should be outside of the remote sensing loop and close to the load. The absolute maximum value of output capacitance is 10,000 μF . For values larger than this contact your local Ericsson representative.

Quality

Reliability

The calculated MTBF of the PKJ 4000B module family is greater than 2.2 million hours using Bellcore TR-332 methodology. The calculation is valid for a 90°C baseplate temperature.

Quality Statement

The power modules are designed and manufactured in an industrial environment where quality systems and methods like ISO 9000, 6 σ , and SPC, are intensively in use to boost the continuous improvements strategy. Infant mortality or early failures in the products are screened out and they are subjected to an ATE-based final test.

Conservative design rules, design reviews and product qualifications, plus the high competence of an engaged work force, contribute to the high quality of our products.

Warranty

Ericsson Inc., Microelectronics warrants to the original purchaser or end user that the products conform to this Data Sheet and are free from material and workmanship defects for a period of five (5) years from the date of manufacture, if the product is used within specified conditions and not opened.

In case the product is discontinued, claims will be accepted up to three (3) years from the date of the discontinuation. For additional details on this limited warranty we refer to Ericsson Inc., Microelectronics "General Terms and Conditions of Sales," EKA 950701, or individual contract documents.

Limitation of Liability

Ericsson Inc., Microelectronics does not make any other warranties, expressed or implied including any warranty of merchantability or fitness for a particular purpose (including, but not limited to use in life support applications, where malfunctions of product can cause injury to a person's health or life).

Product Program

V_I	V_O/I_O	P_{Omax}	Ordering Number
48/60 V	1.8V/40A	72W	PKJ 4718B PIT
48/60 V	2.5V/40A	100W	PKJ 4119B PIT
48/60 V	3.3V/40A	132W	PKJ 4110B PIT

The PKJ 4000B DC/DC power modules will be available with the different options listed in the Product Options table.

Please check with the factory for availability.

Product Options

Option	Suffix	Example
Negative remote on/off logic Industry Standard Trim, (i.e. V_{out} Adjust)	-	<i>PKJ 4110B PIT</i>
Positive remote on/off logic	P	<i>PKJ 4110B PIPT</i>
Lead length of 0.145" \pm 0.010"	LA	<i>PKJ 4110B PITLA</i>

Information given in this data sheet is believed to be accurate and reliable. No responsibility is assumed for the consequences of its use for any infringement of patents or other rights of third parties that may result from its use. No license is granted by implication or otherwise under any patent or patent rights of Ericsson Inc., Microelectronics. These products are sold only according to Ericsson Inc., Microelectronics' general conditions of sale, unless otherwise confirmed in writing. Specifications subject to change without notice.

Ericsson Inc.
Microelectronics
1700 International Pkwy., Suite 200
Richardson, Texas 75081
Phone: 877-ERICMIC
www.ericsson.com/microelectronics

For sales contacts, please refer to our website
or call: 877-374-2642 or fax: 972-583-8355

**The latest and most complete
information can be found on our website!**

Preliminary Data Sheet

AE/LZT 108 4761 R1
© Ericsson Inc., Microelectronics, May 2001