

6–12 W DC/DC Power Modules 24 V Input Series

- SMD and through-hole versions with ultra low component height 8 mm (0.315 in)
- 84% efficiency (typ at 5 V)
- 1,500 V dc isolation voltage
- Output current up to 2 A
- Switching frequency synchronization
- MTBF > 4.9 million hours at +50 °C pin temperature (+40 °C ambient)
- Low EMI measured according to CISPR 22 and FCC part 15J



Patents

US: D357901 DE: M94022763

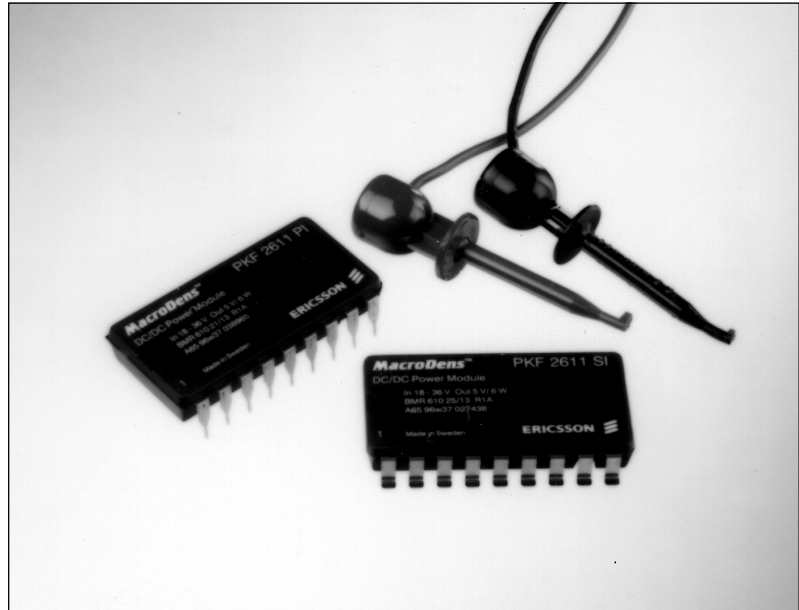

The MacroDens™ PKF 2000 I series true component level on-board DC/DC power modules are intended as distributed power sources in decentralized +24V DC power system.

Utilization of thick film technology and a high degree of silicon integration has made it possible to achieve a MTBF of more than 4.9 million hours. The highly reliable and rugged over-moulded design and the ultra low height makes them particularly suited for cellular radio and other demanding industrial applications, with board spacing down to 15 mm or 0.6 in.

These DC/DC power modules are optimized for free convection cooling and have an operational ambient

temperature range in compliance with present and future application needs, including non temperature controlled environments.

The mechanical design offers the choice of surface mount or through-hole versions, delivered in ready-to-use tubes, trays or tape & reel package, and compatibility with semi and fully aqueous cleaning processes.

The PKF series is manufactured using highly automated manufacturing lines with a world-class quality commitment and a five-year warranty. Ericsson Microelectronics AB has been an ISO 9001 certified supplier since 1991. *For a complete product program please reference the back cover.*



General

Absolute Maximum Ratings

Characteristics		min	max	Unit
T _C	Case temperature at full output power	-45	+100	°C
T _S	Storage temperature	-55	+125	°C
V _I	Continuous input voltage	-0.5	+40	V dc
V _{ISO}	Isolation voltage (input to output test voltage)	1,500		V dc
V _{tr}	Transient input energy		0.01	Ws
V _{RC}	Remote control voltage pin 10, 11 ref. to pin 18	-5	V _I	V dc
V _{adj}	Output adjust voltage pin 8, 9 ref. to pin 18	-5	+40	V dc

Stress in excess of Absolute Maximum Ratings may cause permanent damage. Absolute Maximum Ratings, sometimes referred to as no destruction limits, are normally tested with one parameter at a time exceeding the limits of Output data or Electrical Characteristics. If exposed to stress above these limits, function and performance may degrade in an unspecified manner.

Input T_C < T_{Cmax} unless otherwise specified

Characteristics		Conditions	min	typ	max	Unit
V _I	Input voltage range ¹⁾		18		36	V
V _{Ioff}	Turn-off input voltage	See typical characteristics	16	16.8	18	V
V _{Ion}	Turn-on input voltage	See typical characteristics		18.3	19	V
C _I	Input capacitance			2.4		μF
P _{II}	Input idling power	I _O =0, T _C =-30...+85 °C	(V _I =24V) (V _I =27V)		360 300	mW
P _{RC}	Input stand-by power	T _C =-30...+85 °C, RC connected to pin 18	(V _I =24V) (V _I =27V)		25 40	mW

NOTES:

¹⁾ The power modules will operate down to V_I ≤ 18 V, when V_I decreases, but will turn on at V_I ≤ 19 V, when V_I increases (see also Operating Information).

²⁾ The test is applicable for through-hole versions.

Environmental Characteristics

Characteristics	Test procedure & conditions		
Vibration (Sinusoidal)	JESD 22-B103 (IEC 68-2-6 F _d)	Frequency Amplitude Acceleration Number of cycles	10...500 Hz 0.75 mm 10 g 10 in each axis
Random vibration	MIL-STD-883 Method 2026 (IEC 68-2-34 E _d)	Frequency Acceleration density spectrum Duration Reproducibility	10...500 Hz 0.5 g ² /Hz 10 min in 3 directions medium (IEC 62-2-36)
Shock (Half sinus)	JESD 22-B104 (IEC 68-2-27 E _a)	Peak acceleration Shock duration	200 g 3 ms
Temperature change	JESD 22-A104 (IEC 68-2-14 N _a)	Temperature Number of cycles	-40°C...+125°C 500
Accelerated damp heat	JESD 22-A101 (IEC 68-2-3 C _a with bias)	Temperature Humidity Duration	85°C 85% RH 1000 hours
Solder resistability ²⁾	JESD 22-B106 (IEC 68-2-20 T _b 1A)	Temperature, solder Duration	260°C 10...13 s
Aggressive environment	IEC 68-2-11 K _a	Duration Temperature Concentration	96 h 35°C 5 %

Mechanical Data

Through-hole version

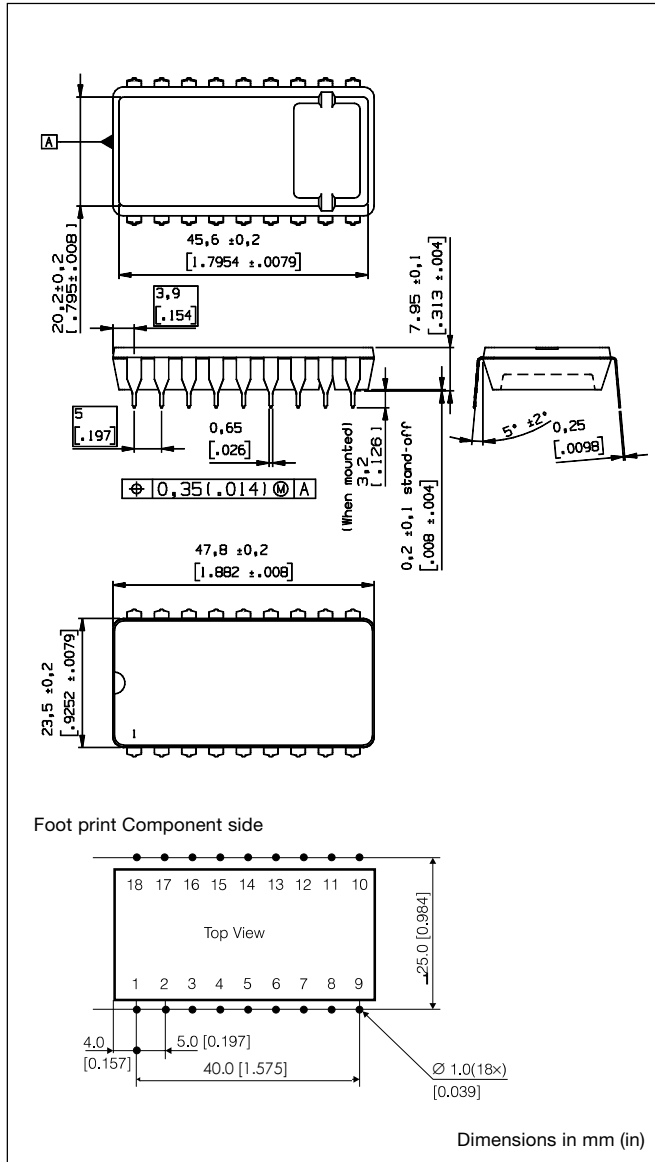

Surface-mount version

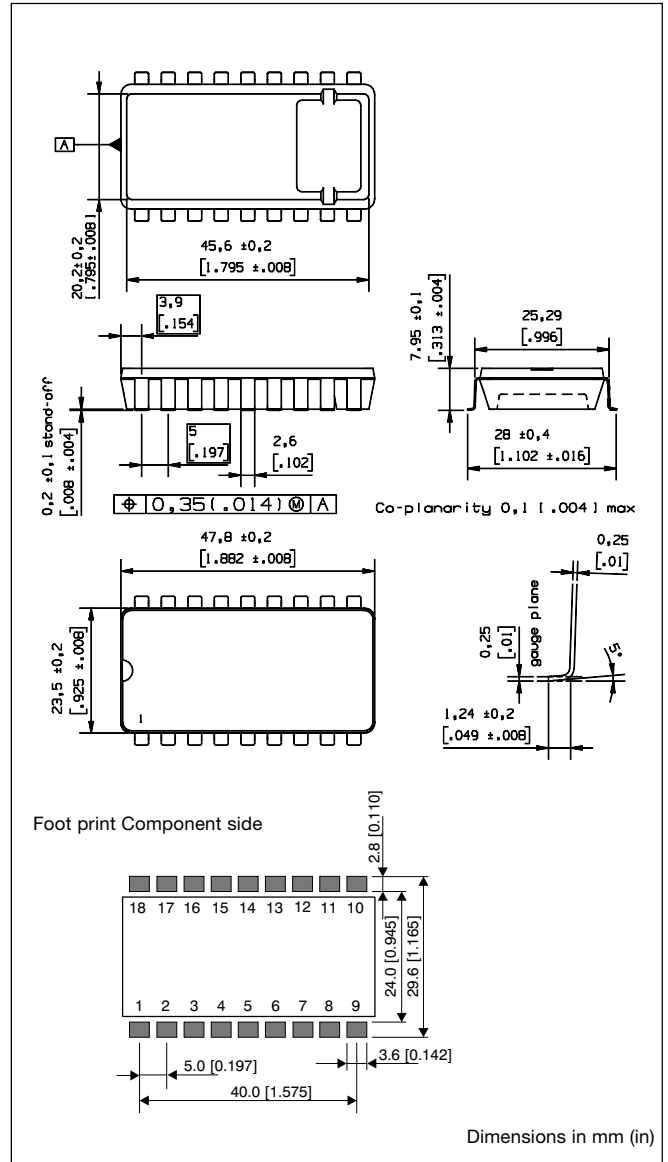

Connections

Pin	Designation	Function
1	Out 1	Output 1. Positive voltage ref. to Rtn.
2	Rtn	Output return.
3-6	NC	Not connected.
7	Sync	Synchronization input.
8	V _{adj}	Output voltage adjust. To set typical output voltage (V _O) connect pin 8 to pin 9.
9	NOR	Connection of Nominal Output voltage Resistor. (See Operating Information, Output Voltage Adjust).
10	TOA	Turn-on/off input voltage adjust (V _{Ion} /V _{Ioff}). Used to decrease the turn-on/off input voltage threshold.
11	RC	Remote control and turn-on/off input voltage adjust. Used to turn-on and turn-off output and to set the turn-on/off input voltage threshold.
12-16	NC	Not connected.
17	+In	Positive input.
18	-In	Negative input.

Weight

Maximum 20 g (0.71 oz).

Case

The case consists of semiconductor grade epoxy with embedded pins. Coefficient of thermal expansion (CTE) is typ. 15 ppm/°C.

Connection Pins

Base material is copper (Cu), first plating is nickel (Ni) and second (outer) plating is palladium (Pd).

Thermal Data

Two-parameter model

This model provides a more precise description of the thermal characteristics to be used for thermal calculations. Thermally the power module can be considered as a component and the case temperature can be used to characterize the properties. The thermal data for a power module with the substrate in contact with the case can be described with two thermal resistances. One from the case to ambient air and one from case to PB (Printed Board).

The thermal characteristics can be calculated from the following formula:

$$T_{PB} = (T_C - T_A) \times (R_{th\ C-PB} + R_{th\ C-A}) / R_{th\ C-A} - P_d \times R_{th\ C-PB} + T_A$$

Where:

- P_d : dissipated power, calculated as $P_O \times (I/h - 1)$
 - T_C : max average case temperature
 - T_A : ambient air temperature at the lower side of the power module
 - T_{PB} : temperature in the PB between the PKF connection pins
 - $R_{th\ C-PB}$: thermal resistance from case to PB under the power module
 - $R_{th\ C-A}$: thermal resistance from case to ambient air
 - v : velocity of ambient air.
 - $R_{th\ C-PB}$ is constant and $R_{th\ C-A}$ is dependent on the air velocity.
- Free convection is equal to an air velocity of approx. 0.2 – 0.3 m/s. See figure below.

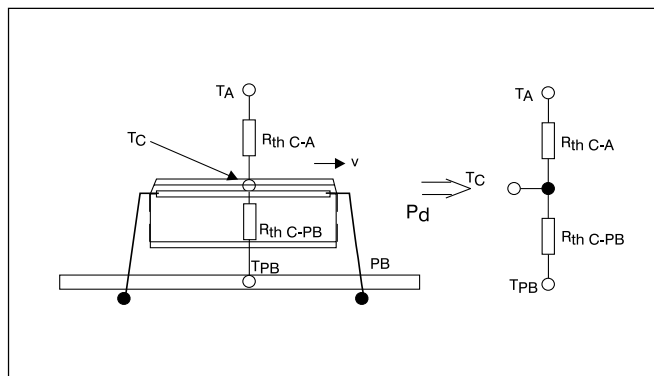
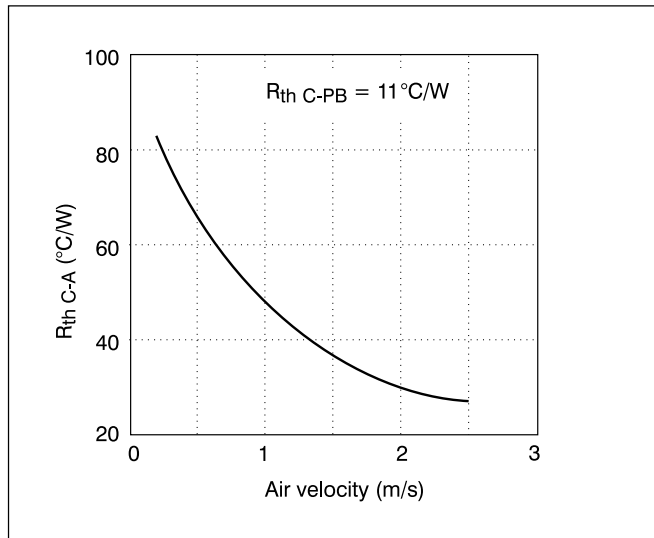

Reflow Soldering Information

The PKF series of DC/DC power modules are manufactured in surface mount technology. Extra precautions must therefore be taken when reflow soldering the surface mount version. Neglecting the soldering information given below may result in permanent damage or significant degradation of power module performance.

The PKF series can be reflow soldered using IR, Natural Convection, Forced Convection or Combined IR/Convection Technologies. The high thermal mass of the component and its effect on ΔT ($^{\circ}C$) requires that particular attention be paid to other temperature sensitive components.

IR Reflow technology may require the overall profile time to be extended to approximately 8–10 minutes to ensure an acceptable ΔT . Higher activity flux may be more suitable to overcome the increase in oxidation and to avoid flux burn-up.

The general profile parameters detailed in the diagram, with this extended time to reach peak temperatures, would then be suitable.

Note! These are maximum parameters. Depending on process variations, an appropriate margin must be added.

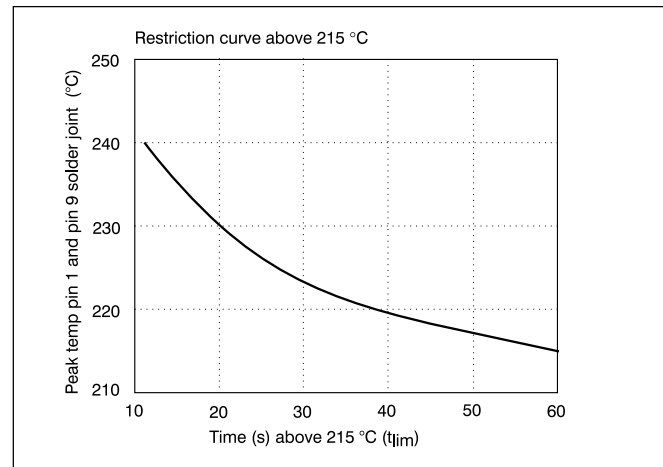
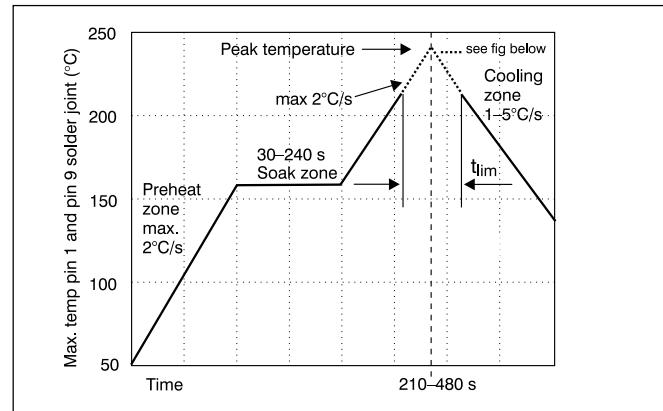

Palladium plating is used on the terminal pins. A pin temperature (T_p) in excess of the solder fusing temperature ($+183^{\circ}C$ for Sn/Pb 63/37) for more than 25 seconds and a peak temperature above $195^{\circ}C$, is required to guarantee a reliable solder joint.

Both pin 1 and pin 9 must be monitored.

No responsibility is assumed if these recommendations are not strictly followed.

Safety

The PKF 2000 I series DC/DC power modules are designed in accordance with EN 60 950, *Safety of information technology equipment including electrical business equipment*. SEMKO certificate no. 9738248.

The PKF power modules are recognized by UL and meet the applicable requirements in UL 1950 *Safety of information technology equipment*, the applicable Canadian safety requirements and UL 1012 *Standard for power supplies*.

The DC/DC power module shall be installed in an end-use equipment and considerations should be given to measuring the case temperature to comply with T_{Cmax} when in operation. Abnormal component tests are conducted with the input protected by an external 3 A fuse. The need for repeating these tests in the end-use appliance shall be considered if installed in a circuit having higher rated devices.

The isolation is an operational insulation in accordance with EN 60 950.

The DC/DC power module is intended to be supplied by isolated secondary circuitry and shall be installed in compliance with the requirements of the ultimate application. One pole of the input and one pole of the output is to be grounded or both are to be kept floating.

The terminal pins are only intended for connection to mating connectors of internal wiring inside the end-use equipment.

These DC/DC power modules may be used in telephone equipment in accordance with paragraph 34 A.1 of UL 1459 (Standard for Telephone Equipment, second edition).

The galvanic isolation is verified in an electric strength test. Test voltage (V_{ISO}) between input and output is 1,500 Vdc for 60 s. In production the test duration is decreased to 1 s.

The capacitor between input and output has a value of 1 nF and the leakage current is less than $1\mu A @ 26 Vdc$.

The case is designed in non-conductive epoxy. Its flammability rating meets UL 94V-0. The oxygen index is 34%.

Electrical Data

Fundamental circuit diagram, Single output

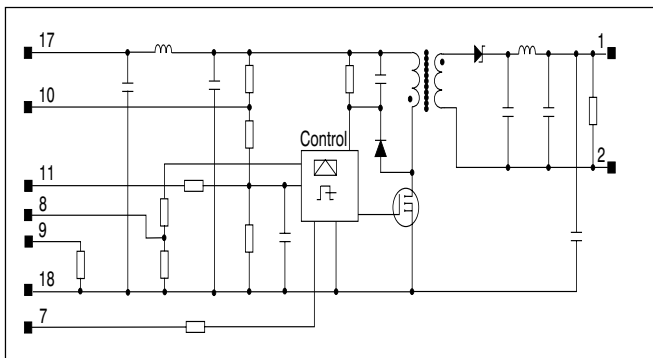

PKF 2111A PI, SI

$T_C = -30...+95^{\circ}\text{C}$, $V_I = 18...36\text{V}$ and pin 8 connected to pin 9 unless otherwise specified.

Output

Characteristics		Conditions		Output 1			Unit	
				min	typ	max		
V_{O_i}	Output voltage initial setting and accuracy	$T_C = +25^{\circ}\text{C}$, $I_O = 1.5\text{A}$, $V_I = 27\text{V}$		5.02	5.05	5.08	V	
	Output adjust range ¹⁾			2.76		6.27	V	
V_O	Output voltage tolerance band	Long term drift included, $T_C > -10^{\circ}\text{C}$ ²⁾	$I_O = 0.2...2.0\text{A}$	4.85		5.25	V	
	Idling voltage	$I_O = 0\text{A}$			5.7	6.5	V	
	Line regulation	$I_O = 2\text{A}$	$V_I = 18...36\text{V}$	22			mV	
			$V_I = 24...36\text{V}$	15				
	Load regulation	$I_O = 0.2...2.0\text{A}$, $V_I = 27\text{V}$		104	119	213	mV	
t_{tr}	Load transient recovery time	$I_O = 0.2...2.0\text{A}$, $V_I = 27\text{V}$ load step = 1 A		400			μs	
V_{tr}	Load transient voltage			+200			mV	
				-200			mV	
T_{coeff}	Temperature coefficient ²⁾	$I_O = 2\text{A}$, $T_C = 40...90^{\circ}\text{C}$		-0.34			mV/ $^{\circ}\text{C}$	
t_r	Ramp-up time	$I_O = 2\text{A}$, $0.1...0.9 \times V_{O_i}$		2			ms	
t_s	Start-up time	$I_O = 0.2...2.0\text{A}$, $V_I = 27\text{V}$ From V_I connection to $V_O = 0.9 \times V_{O_i}$		3			ms	
I_O	Output current			0		2	A	
P_{Omax}	Max output power ²⁾	Calculated value		10			W	
I_{lim}	Current limiting threshold	$T_C < T_{Cmax}$, $V_O = 4\text{V}$		2.24	2.38	2.47	A	
I_{sc}	Short circuit current	$V_O = 0.2...0.5\text{V}$, $T_A = +25^{\circ}\text{C}$		2.4			3.6	A
V_{Oac}	Output ripple & noise	$I_O = 2\text{A}$	20 Hz... 5 MHz	13			50	mV _{p-p}
			0.6...50 MHz				80	dB μV
SVR	Supply voltage rejection (ac)	f = 100 Hz sine wave, 1 V _{p-p} , $V_I = 27\text{V}$ (SVR = 20 log (1 V _{p-p} /V _{O p-p}))		50			dB	

¹⁾ See also Operating Information.

²⁾ See also Typical Characteristics.

Miscellaneous

Characteristics		Conditions		min	typ	max	Unit
η	Efficiency	$I_O = 2\text{A}$	$V_I = 24\text{V}$	81	83		%
			$V_I = 27\text{V}$	78	82		
P_d	Power dissipation		$V_I = 24\text{V}$		2.1	2.4	W
			$V_I = 27\text{V}$		2.2	2.9	

PKF 2113 PI, SI

$T_C = -30...+95^\circ\text{C}$, $V_I = 18...36\text{V}$ and pin 8 connected to pin 9 unless otherwise specified.

Output

Characteristics		Conditions		Output 1			Unit
				min	typ	max	
V_{O_i}	Output voltage initial setting and accuracy	$T_C = +25^\circ\text{C}$, $I_O = 0.8\text{A}$, $V_I = 27\text{V}$		11.94	12.00	12.06	V
	Output adjust range ¹⁾			6.5		15.0	V
V_O	Output voltage tolerance band	Long term drift included	$I_O = 0.1...1.0\text{A}$	11.6		12.6	V
	Idling voltage	$I_O = 0\text{A}$			13.4	16.3	V
	Line regulation	$I_O = 1\text{A}$	$V_I = 18...36\text{V}$		33		mV
	Load regulation	$I_O = 0.1...1.0\text{A}$, $V_I = 27\text{V}$			224		mV
t_{tr}	Load transient recovery time	$I_O = 0.1...1.0\text{A}$, $V_I = 27\text{V}$ load step = 0.5 A			760		μs
V_{tr}	Load transient voltage				+120		mV
					-120		mV
T_{coeff}	Temperature coefficient ²⁾	$I_O = 1\text{A}$, $T_C = 40...90^\circ\text{C}$			0		mV/ $^\circ\text{C}$
t_r	Ramp-up time	$I_O = 1\text{A}$, $0.1...0.9 \times V_{O_i}$			2.3		ms
t_s	Start-up time	$I_O = 0.1...1.0\text{A}$, $V_I = 27\text{V}$ From V_I connection to $V_O = 0.9 \times V_{O_i}$			3.1		ms
I_O	Output current			0		1	A
P_{Omax}	Max output power ²⁾	Calculated value		12			W
I_{lim}	Current limiting threshold	$T_C < T_{Cmax}$, $V_O = 9.6\text{V}$			1.4		A
I_{sc}	Short circuit current	$V_O = 0.2...0.5\text{V}$, $T_A = +25^\circ\text{C}$			2.1		A
V_{Oac}	Output ripple & noise	$I_O = 1\text{A}$	20 Hz... 5 MHz		15	50	mV _{p-p}
			0.6...50 MHz			80	dB μV
SVR	Supply voltage rejection (ac)	f = 100 Hz sine wave, 1 V _{p-p} , $V_I = 27\text{V}$ (SVR = 20 log (1 V _{p-p} /V _{O p-p}))			50		dB

¹⁾ See also Operating Information.

²⁾ See also Typical Characteristics.

Miscellaneous

Characteristics		Conditions		min	typ	max	Unit
η	Efficiency	$I_O = 1\text{A}$	$V_I = 24\text{V}$	83	86		%
			$V_I = 27\text{V}$	83	86		
P_d	Power dissipation		$V_I = 24\text{V}$		2	2.5	W
			$V_I = 27\text{V}$		2	2.5	

PKF 2610A PI, SI

$T_C = -30...+95^\circ\text{C}$, $V_I = 18...36\text{V}$ and pin 8 connected to pin 9 unless otherwise specified.

Output

Characteristics		Conditions		Output 1			Unit
				min	typ	max	
V_{O_i}	Output voltage initial setting and accuracy	$T_C = +25^\circ\text{C}$, $I_O = 1.0\text{A}$, $V_I = 27\text{V}$		3.27	3.30	3.33	V
	Output adjust range ¹⁾			1.80		3.80	V
V_O	Output voltage tolerance band	Long term drift included	$I_O = 0.2...2.0\text{A}$	3.17		3.43	V
	Idling voltage	$I_O = 0\text{A}$			3.8	4.0	V
	Line regulation	$I_O = 2\text{A}$	$V_I = 18...36\text{V}$		50		mV
			$V_I = 27...36\text{V}$		35		
	Load regulation	$I_O = 0.2...2.0\text{A}$, $V_I = 27\text{V}$			120		mV
t_{tr}	Load transient recovery time	$I_O = 0.2...2.0\text{A}$, $V_I = 27\text{V}$ load step = 1 A			100		μs
V_{tr}	Load transient voltage				+180		mV
					-180		mV
T_{coeff}	Temperature coefficient ²⁾	$I_O = 2\text{A}$, $T_C = 40...90^\circ\text{C}$			-0.55		mV/ $^\circ\text{C}$
t_r	Ramp-up time	$I_O = 2\text{A}$, $0.1...0.9 \times V_{O_i}$			2.3		ms
t_s	Start-up time	$I_O = 0.2...2.0\text{A}$, $V_I = 27\text{V}$ From V_I connection to $V_O = 0.9 \times V_{O_i}$			4.4		ms
I_O	Output current			0		2	A
P_{Omax}	Max output power ²⁾	Calculated value		6.6			W
I_{lim}	Current limiting threshold	$T_C < T_{Cmax}$		2.2		2.6	A
I_{sc}	Short circuit current	$V_O = 0.2...0.5\text{V}$, $T_A = +25^\circ\text{C}$			2.9		A
V_{Oac}	Output ripple & noise	$I_O = 2\text{A}$	20 Hz... 5 MHz		15	50	mV _{p-p}
			20 Hz...50 MHz			80	dB μV
SVR	Supply voltage rejection (ac)	f = 100 Hz sine wave, 1 V _{p-p} , $V_I = 27\text{V}$ (SVR = 20 log (1 V _{p-p} /V _{O p-p}))			63		dB

¹⁾ See also Operating Information.

²⁾ See also Typical Characteristics.

Miscellaneous

Characteristics		Conditions	min	typ	max	Unit
η	Efficiency	$I_O = 2\text{A}$, $V_I = 27\text{V}$	76	81		%
P_d	Power dissipation	$I_O = 2\text{A}$, $V_I = 27\text{V}$		1.6	2.1	W

PKF 2611 PI, SI

$T_C = -30...+95^{\circ}\text{C}$, $V_I = 18...36\text{V}$ and pin 8 connected to pin 9 unless otherwise specified.

Output

Characteristics		Conditions		Output 1			Unit
				min	typ	max	
V_{O_i}	Output voltage initial setting and accuracy	$T_C = +25^{\circ}\text{C}$, $I_O = 0.5\text{ A}$, $V_I = 27\text{ V}$		5.02	5.05	5.08	V
	Output adjust range ¹⁾			4.30		5.80	V
V_O	Output voltage tolerance band	Long term drift included	$I_O = 0.12...1.2\text{ A}$	4.85		5.25	V
	Idling voltage	$I_O = 0\text{ A}$			5.8		V
	Line regulation	$I_O = 1.2\text{ A}$	$V_I = 18...36\text{ V}$		30		mV
			$V_I = 27...36\text{ V}$		10		
	Load regulation	$I_O = 0.12...1.2\text{ A}$, $V_I = 27\text{ V}$			125		mV
t_{tr}	Load transient recovery time	$I_O = 0.12...1.2\text{ A}$, $V_I = 27\text{ V}$ load step = 0.6 A			50		μs
V_{tr}	Load transient voltage				+100		mV
					-100		mV
T_{coeff}	Temperature coefficient ²⁾	$I_O = 1.2\text{ A}$, $T_C = 40...90^{\circ}\text{C}$			-0.8		mV/ $^{\circ}\text{C}$
t_r	Ramp-up time	$I_O = 1.2\text{ A}$, $0.1...0.9 \times V_{O_i}$			2.3		ms
t_s	Start-up time	$I_O = 0.12...1.2\text{ A}$, $V_I = 27\text{ V}$ From V_I connection to $V_O = 0.9 \times V_{O_i}$			4.6		ms
I_O	Output current			0		1.2	A
P_{Omax}	Max output power ²⁾	Calculated value		6			W
I_{lim}	Current limiting threshold	$T_C < T_{Cmax}$		1.3	1.6	2.4	A
I_{sc}	Short circuit current	$V_O = 0.2...0.5\text{ V}$, $T_A = +25^{\circ}\text{C}$			2.0		A
V_{Oac}	Output ripple & noise	$I_O = 1.2\text{ A}$	20 Hz... 5 MHz		20	70	mVp-p
			20 Hz...50 MHz			80	dB μV
SVR	Supply voltage rejection (ac)	f = 100 Hz sine wave, 1 Vp-p, $V_I = 27\text{ V}$ (SVR = 20 log (1 Vp-p/ $V_{O p-p}$))			60		dB

¹⁾ See also Operating Information.

²⁾ See also Typical Characteristics.

Miscellaneous

Characteristics		Conditions	min	typ	max	Unit
η	Efficiency	$I_O = 1.2\text{ A}$, $V_I = 27\text{ V}$	79	83		%
P_d	Power dissipation	$I_O = 1.2\text{ A}$, $V_I = 27\text{ V}$		1.2	1.6	W

Typical Characteristics

PKF 2111A PI, SI

Output characteristic (typ)

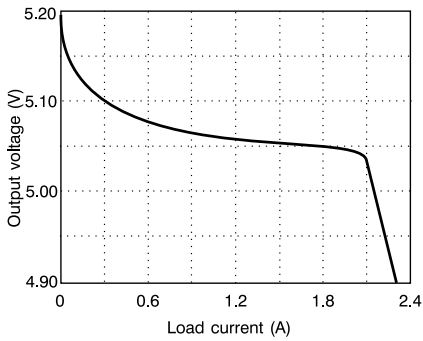

Power derating

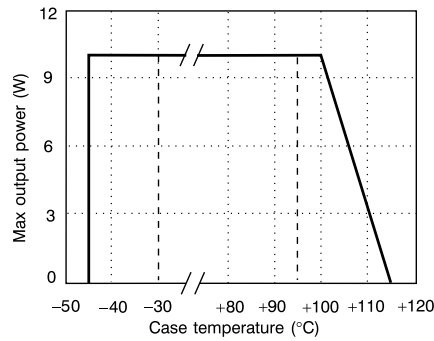

Efficiency (typ) @ T_A = 25°C

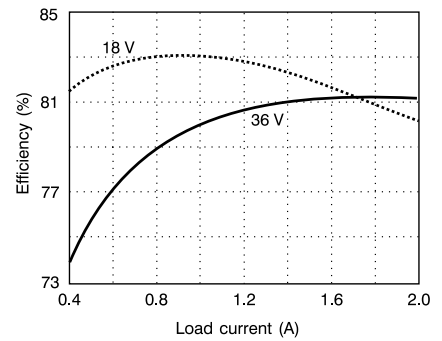

Temperature coefficient

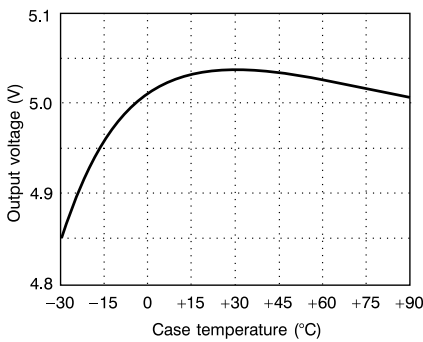

Turn-on/turn-off input voltage

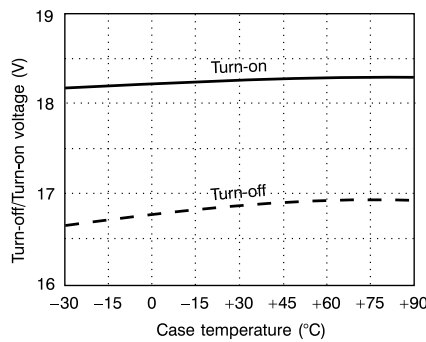

Dynamic load response (typ) @ +25°C

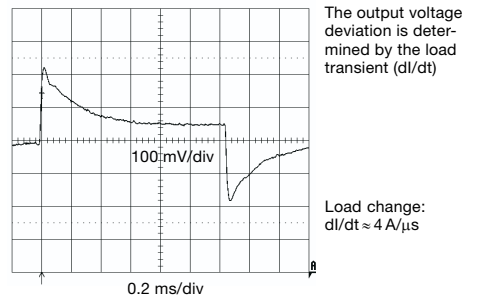

PKF 2113A PI, SI

Output characteristic (typ)

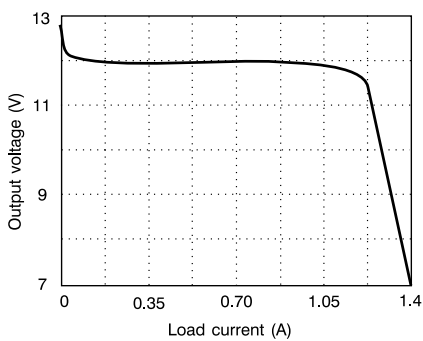

Power derating

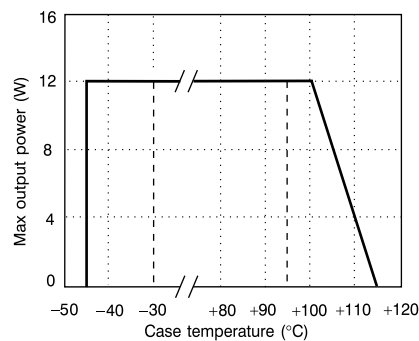

Efficiency (typ) @ T_A = 25°C

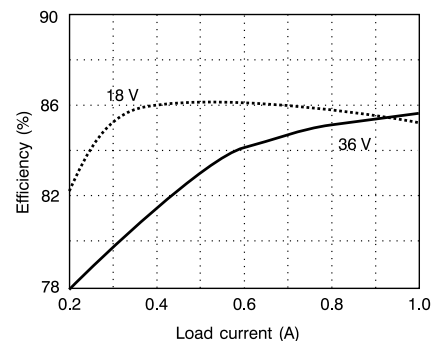

Temperature coefficient

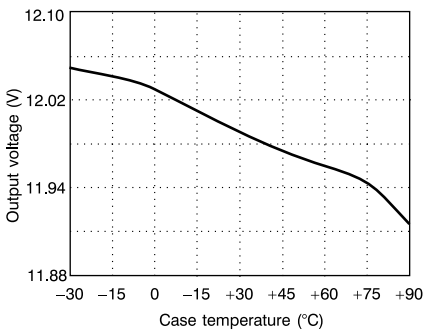

Turn-on/turn-off input voltage

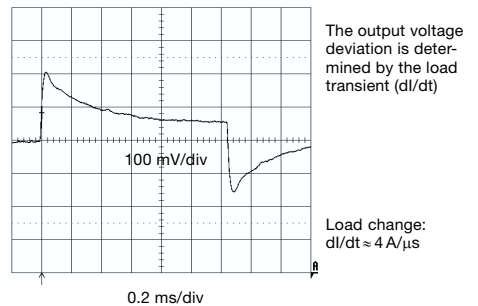
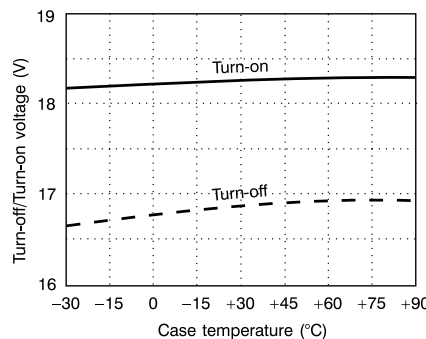

Typical Characteristics

PKF 2610A PI, SI

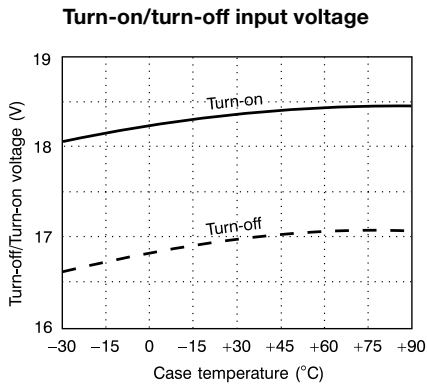
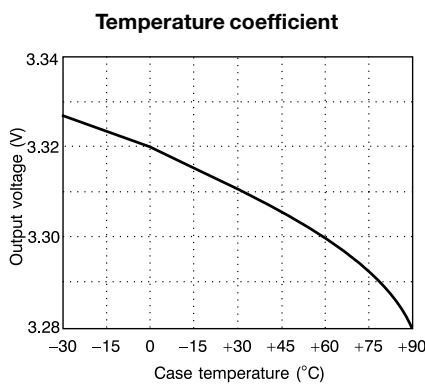
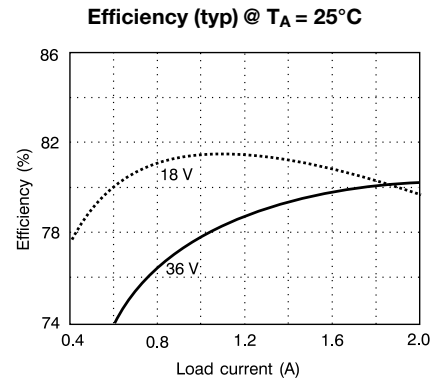
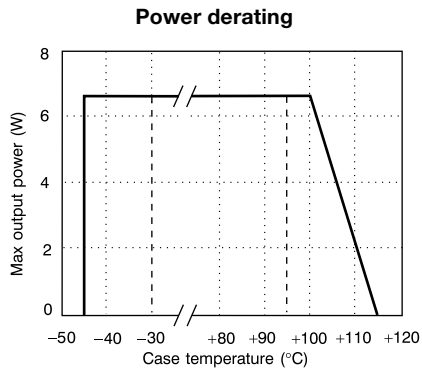
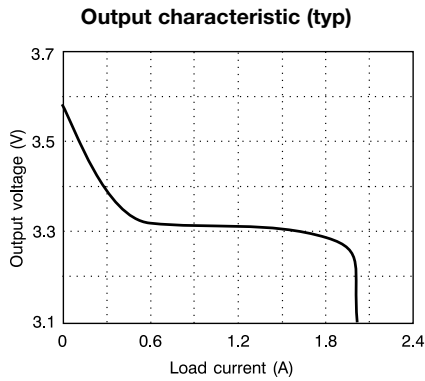

PKF 2611 PI, SI

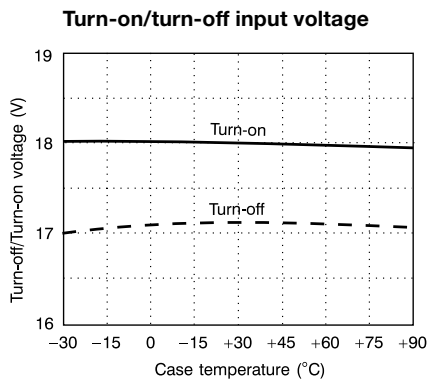
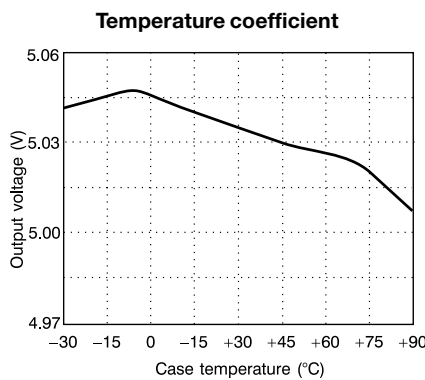
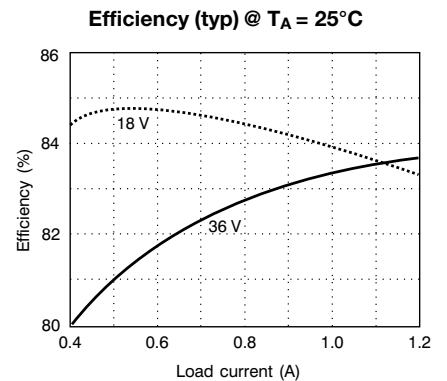
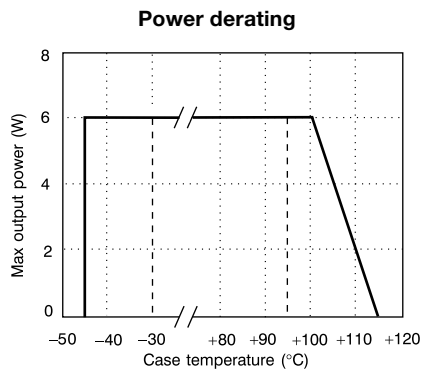
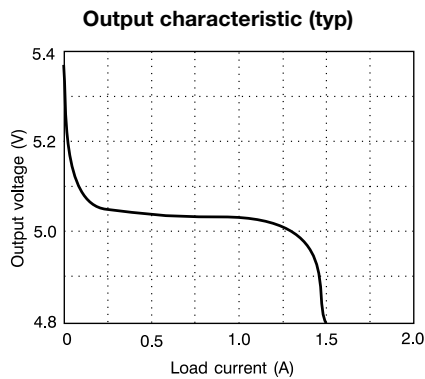

EMC Specifications

The fundamental switching frequency is 510 kHz \pm 10 kHz.

Conducted EMI (input terminals)

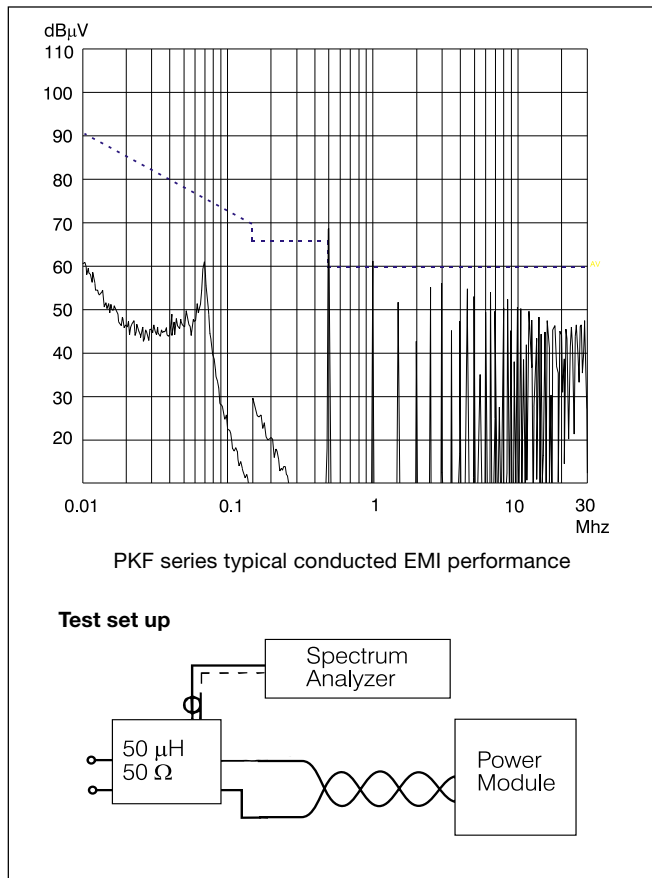

The PKF meets class A in VDE 0871/0878, FCC Part 15J, and CISPR 22 (EN 55022), except for the fundamental switching frequency.

Radiated EMI

Radiated emission of electromagnetic fields is measured at 10 m distance.

30...100 MHz	60 dB μ V/m
100...200 MHz	40 dB μ V/m
200...230 MHz	30 dB μ V/m
230...1,000 MHz	35 dB μ V/m
1...10 GHz	46 dB μ V/m

Conducted EMS

Electro Magnetic Susceptibility is measured by injection of electrical disturbances on the input terminals. No deviation outside the V_O tolerance band will occur under the following conditions:

Frequency range	Voltage level
0.15...300 MHz	1.0 V_{rms}

The signal is amplitude modulated with 1 kHz/80% and applied in differential and common mode.

Radiated EMS (Electro-Magnetic Fields)

Radiated EMS is measured according to test methods in IEC Standard publ. 801-3. No deviation outside the V_O tolerance band will occur under the following conditions:

Frequency range	Voltage level
0.01...200 MHz	3 V_{rms}/m
200...1,000 MHz	3 V_{rms}/m
1...12 GHz	10 V_{rms}/m

ESD

Electro Static Discharge is tested according to IEC publ. 801-2. No destruction will occur if the following voltage levels are applied to any of the terminal pins:

Test	Voltage level
Air discharge	\pm 4 kV
Contact discharge	\pm 2 kV

EFT

Electrical Fast Transients on the input terminals could affect the output voltage regulation causing functional errors on the Printed Board Assembly (PBA). The PKF power module withstand EFT levels of 0.5 kV keeping V_O within the tolerance band and 2.0 kV without destruction. Tested according to IEC publ. 801-4.

Output Ripple & Noise (V_{oac})

Output ripple is measured as the peak to peak voltage of the fundamental switching frequency.

Operating Information

Fuse Considerations

To prevent excessive current from flowing through the input supply line, in the case of a short-circuit across the inverter input, an external fuse should be installed in the non-earthed input supply line. We recommend using a fuse rated at approximately 2 to 4 times the value calculated in the formula below:

$$I_{inmax} = \frac{P_{Omax}}{(\eta_{min} \times V_{Imin})}$$

Refer to the fuse manufacturer for further information.

Remote Control (RC)

Turn-on or turn-off can be realized by using the RC-pin. Normal operation is achieved if pin 11 is open (NC). If pin 11 is connected to pin 18 the power module turns off. To ensure safe turn-off the voltage difference between pin 11 and 18 shall be less than 1.0V. RC is an TTL open collector compatible output with a sink capacity >300 mA (see fig. 1).

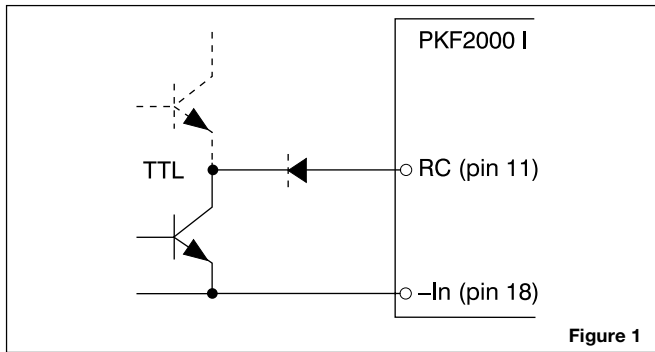

Figure 1

Over Voltage Protection (OVP)

The remote control can be utilized also for OVP by using the external circuitry in figure 2. Resistor values are for 5V output applications, but can easily be adjusted for other output voltages and the desired OVP level.

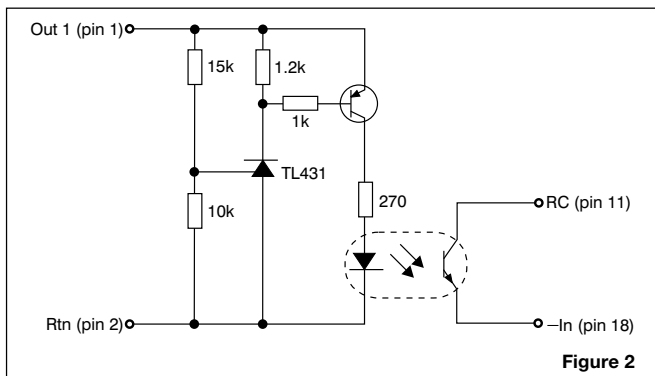

Figure 2

Turn-on/off Input Voltage

The power module monitors the input voltage and will turn on and off at predetermined levels. The typical turn-on level (without any external resistor) is 18.4 V and the typical turn-off level is 17.0 V, a slight deviation can occur due to tolerances in the manufacturing process. These levels can be adjusted by means of external resistors.

To increase V_{Ion} a resistor should be connected between pin 11 and 18 (see fig. 3).

The resistance is given by the following equation (For $V_{Ion} > 18.4V$):

$$R_{Ion} = (k_1 - V_{Ion}) / (V_{Ion} - k_2) \text{ kW}$$

where k_2 is the typical unadjusted turn-on input voltage (V).

To decrease V_{Ion} a resistor should be connected between pin 10 and 11 (see fig. 3). The resistance is given by the following equation (for $17.0V < V_{Ion} > 18.3V$):

$$R_{Ion} = k_3 \times (V_{Ion} - k_4) / (k_2 - V_{Ion}) \text{ kW}$$

k_1	k_2	k_3	k_4	
1020	18.3	22	16.9	PKF 2111A, PKF 2113A
1020	18.4	27	17.0	PKF 2610A
1020	18.4	25	17.0	PKF 2611

Turn-off level. V_{Ioff} is the adjusted turn-off level and is determined by the following equation: $V_{Ioff} = V_{Ion} - 1.5V$ (typical value).

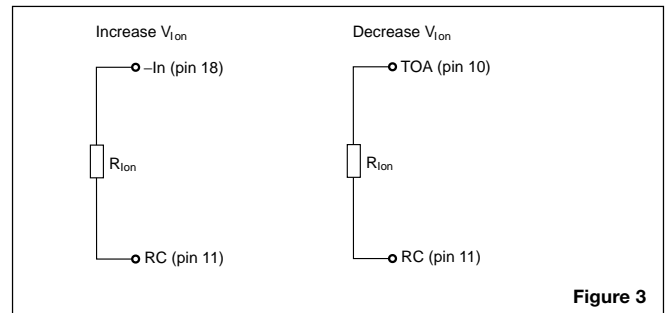

Figure 3

Output Voltage Adjust (V_{adj})

Output voltage, V_O , can be adjusted by using an external resistor. Typical adjust range is $\pm 15\%$. If pin 8 and 9 is not connected together the output will decrease to a low value. To increase V_O a resistor should be connected between pin 8/9 and 18, and to decrease V_O a resistor should be connected between pin 8 and 9 (see fig. 4).

Typical required resistor value to increase V_O is given by:

$$R_{adj} = k_5 \times (k_6 - V_O) / (V_O - V_{O_i}) \text{ kW}$$

where V_O is the desired output voltage,

V_{O_i} is the typical output voltage initial setting

and	$k_5 = 4.2$	$k_6 = 6.27 \text{ V}$	PKF 2111A
	$k_5 = 4.2$	$k_6 = 15.0 \text{ V}$	PKF 2113A
	$k_5 = 3.18$	$k_6 = 3.90 \text{ V}$	PKF 2610A
	$k_5 = 3.18$	$k_6 = 5.85 \text{ V}$	PKF 2611

Typical required resistor value to decrease V_O is given by:

$$R_{adj} = k_7 \times (V_{O_i} - V_O) / (V_O - k_8) \text{ kW}$$

where	$k_7 = 18.0$	$k_8 = 2.76 \text{ V}$	PKF 2111A
	$k_7 = 18.6$	$k_8 = 6.50 \text{ V}$	PKF 2113A
	$k_7 = 17.2$	$k_8 = 1.70 \text{ V}$	PKF 2610A
	$k_7 = 12.5$	$k_8 = 4.28 \text{ V}$	PKF 2611

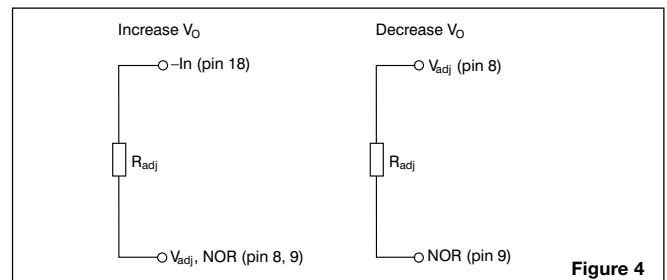

Figure 4

Capacitive Load

The PKF series has no maximum limit for capacitive load on the output. The power module may operate in current limiting mode during start-up, affecting the ramp-up and the start-up time. For optimum start performance we recommend maximum 100 $\mu\text{F}/\text{A}$ of I_{O} . Connect capacitors at the point of load for best performance.

Parallel Operation

Paralleling of several converters is easily accomplished by direct connection of the output voltage terminal pins. The load regulation characteristic is specifically designed for optimal paralleling performance. Load sharing between converters will be within $\pm 10\%$. It is recommended not to exceed $P_{\text{O}} = n \times 0.9 \times P_{\text{Omax}}$, where P_{Omax} is the maximum converter output power and n the number of paralleled converters, to prevent overloading any of the converters and thereby decreasing the reliability performance.

Current Limiting Protection (I_{lim})

The output power is limited at loads above the output current limiting threshold (I_{lim}), specified as a minimum value.

Synchronization (Sync)

It is possible to synchronize the switching frequency to an external symmetrical clock signal. The input is TTL-compatible and referenced to the input pin 18.

Characteristics	min	typ	max	unit
High level	2.2		6.5	V
Threshold level ¹⁾	1.2	1.7	2.2	V
Low level	0		0.4	V
Sink current			1.5	mA
Sync. frequency	520		688	kHz

¹⁾ Rise time <10ns

Input and Output Impedance

Both the source impedance of the power feeding and the load impedance will interact with the impedance of the DC/DC power module.

It is most important to have the ratio between L and C as low as possible, i.e. a low characteristic impedance, both at the input and output, as the power modules have a low energy storage capability.

Use an electrolytic capacitor across the input if the source inductance is larger than 10 μH . Their equivalent series resistance together with the capacitance acts as a lossless damping filter. Suitable capacitor values are in the range 10–100 μF .

Delivery Package Information

Tubes

The PKF-series is delivered in tubes (designated by /A) with a length of 500 mm (19.69 in), see fig. 5.

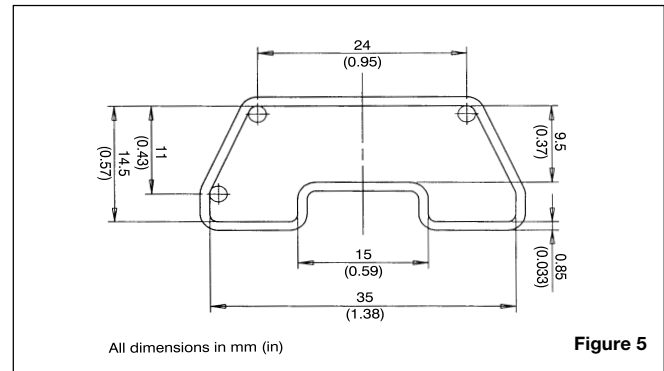

Figure 5

Specification

Material:	Antistatic coated PVC
Max surface resistance:	$10^{11}\Omega/\square$
Color:	Transparent
Capacity:	10 power modules/tube
Weight:	Typ. 60 g
End stops:	Pins

Trays

SMD versions, SI, can be delivered in standard JEDEC trays (designated by /B) on request, see fig. 6. For more information, please contact your local Ericsson sales office.

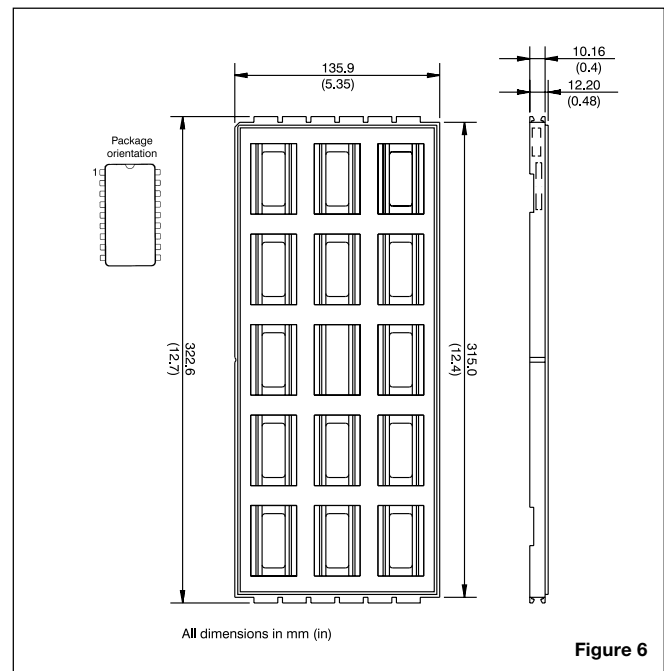

Figure 6

Specification

Material:	Polypropylene (PP)
Max temperature:	125°C
Max surface resistance:	$10^5\text{W}/\square$
Color:	Black

Capacity: 15 power modules/tray
 Stacking pitch: 10.16 mm
 Weight: Typ. 130 g
 Min. order quantity: 150 pcs (one box contains 10 full trays)

Tape & Reel

SMD versions, SI, can be delivered in standard tape & reel package (designated by /C) on request, see fig. 7. For more information, please contact your local Ericsson sales office.

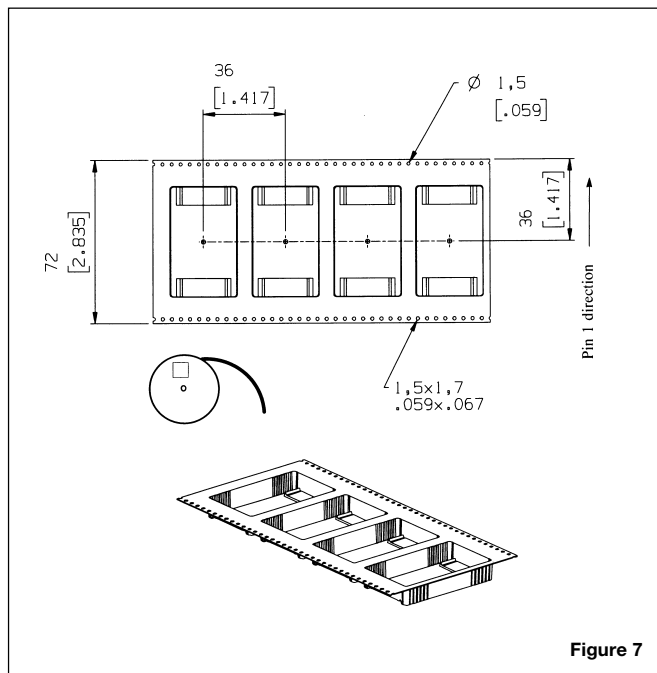

Figure 7

Specification

Tape material: Conductive polystyrene (PS)
 Tape width: 72 mm
 Tape pitch: 36 mm
 Max surface resistance: $10^5 \text{W}/\square$
 Tape color: Black
 Cover tape color: Transparent
 Reel diameter: 13"
 Reel hub diameter: 7"
 Reel capacity: 150 power modules/reel
 Full reel weight: Typ. 3.7 kg
 Min. order quantity: 300 pcs (one box contains two reels)

Quality

Reliability

Mean time between failure (MTBF) is calculated to >4.9 million hours at full output power and a pin temperature of +50°C ($T_A = +40^\circ\text{C}$), using the Ericsson failure rate data system. The Ericsson failure rate data system is based on field failure rates and is continuously updated. The data corresponds to actual failure rates of components used in Information Technology and Telecom equipment in temperature controlled environments ($T_A = -5 \dots +65^\circ\text{C}$). The data is considered to have a confidence level of 90%. For more information see Design Note 002.

Quality Statement

The products are designed and manufactured in an industrial environment where quality systems and methods like ISO 9000, 6s and SPC, are intensively in use to boost the continuous improvements strategy. Infant mortality or early failures in the products are screened out by a burn-in procedure and an ATE-based final test.

Conservative design rules, design reviews and product qualifications, plus the high competence of an engaged work force, contribute to the high quality of our products.

Warranty

Ericsson Microelectronics warrants to the original purchaser or end user that the products conform to this Data Sheet and are free from material and workmanship defects for a period of five (5) years from the date of manufacture, if the product is used within specified conditions and not opened. In case the product is discontinued, claims will be accepted up to three (3) years from the date of the discontinuation.

For additional details on this limited warranty please refer to Ericsson Microelectronics AB's "General Terms and Conditions of Sales", or individual contract documents.

Limitation of liability

Ericsson Microelectronics does not make any other warranties, expressed or implied including any warranty of merchantability or fitness for a particular purpose (including, but not limited to, use in life support applications, where malfunctions of product can cause injury to a person's health or life).

Information given in this data sheet is believed to be accurate and reliable. No responsibility is assumed for the consequences of its use nor for any infringement of patents or other rights of third parties which may result from its use. No license is granted by implication or otherwise under any patent or patent rights of Ericsson Microelectronics. These products are sold only according to Ericsson Microelectronics' general conditions of sale, unless otherwise confirmed in writing. Specifications subject to change without notice.

Product Program

V _I	V _O /I _O max	P _O max	Ordering No. ¹⁾	
	Output 1		Through-hole	SMD
24 V	5 V/2.0 A	10 W	PKF 2111A PI	PKF 2111A SI
	12 V/1.0 A	12 W	PKF 2113A PI	PKF 2113A SI
	3.3 V/2.0 A	6.6 W	PKF 2610A PI	PKF 2610A SI
	5 V/1.2 A	6.0 W	PKF 2611 PI	PKF 2611 SI

¹⁾ See also Delivery Package Information

Ericsson Microelectronics AB
SE-164 81 KISTA, Sweden
Phone: +46 8 757 5000
www.ericsson.com/microelectronics

For local sales contacts, please refer to our website
or call: Int. +46 8 757 4700, Fax: +46 8 757 4776

The latest and most complete information can be found on our website!

Data Sheet

EN/LZT 146 31 R1A (Replaces EN/LZT 137 21 R6)
© Ericsson Microelectronics AB, June 2000