

15–18 W DC/DC Power Modules 24 V Input Series

- Regulated single, dual and triple outputs
- Low profile 10.7 mm (0.42 in.), allows 0.8" board pitch – 0.6 in. if recessed in the printed board
- Proven MTBF >2,000,000 hours at +75 °C case temperature and a rugged mechanical construction
- Efficiency 85% typ, at full load. No extra heatsink up to +85°C ambient. Max. +115°C case
- Low EMI in conformance with class A in EN 55022 and FCC part 15J

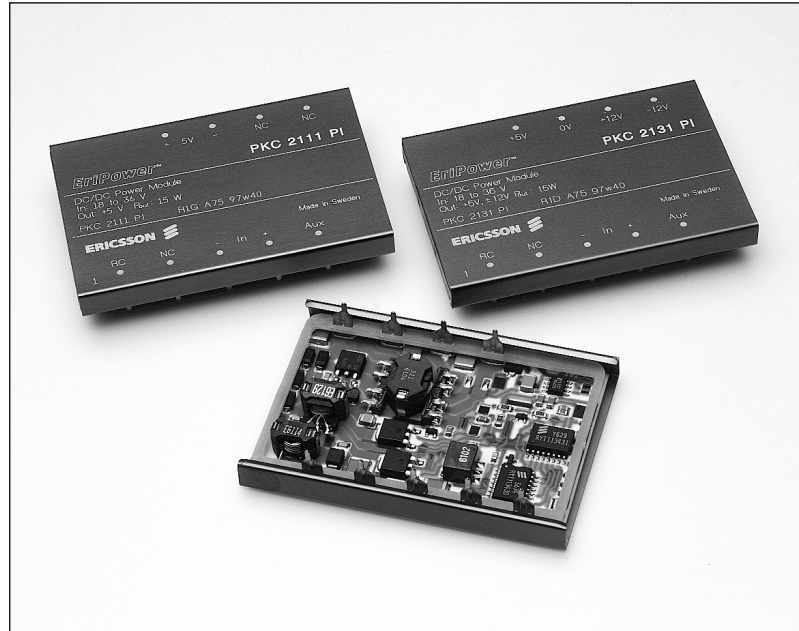

The 15–18 watts PKC series DC/DC power modules are especially designed for decentralized 24 and 28 Vdc systems with distributed on-board DC/DC converters. Their low profile allows very narrow board pitches and slim designs. By using thickfilm technology, which provides a high degree of integration as well as efficient thermal management, and by utilizing a 300 kHz switching frequency based on proprietary drive & control circuits, these highly reliable products can be used in demanding applications within e.g. cellular radio, medical, industrial and aircraft industry.

By using magnetic integration of the output voltages in the feedback loop, all outputs are kept within a $\pm 3\%$ total tolerance band. Input to output isolation is

500 Vdc and mechanical ruggedness – specified in conformance with IEC 68-2 – is close to requirements for discrete components. Extreme temperature conditions can be met since the PKC power modules can operate with full output power in ambient temperatures from -45 to $+85^\circ\text{C}$, or up to $+115^\circ\text{C}$ case temperature also making the products ideal for applications within not temperature controlled environments.

The PKC series are manufactured using highly automated manufacturing lines with a world-class quality commitment and a five-year warranty. Ericsson Microelectronics AB has been an ISO 9001 certified supplier since 1991. For a complete product program please refer to the back cover.



General

Absolute Maximum Ratings

Characteristics		min	max	Unit
T _C	Case temperature ¹⁾	-45	+115	°C
T _S	Storage temperature	-55	+125	°C
V _I	Input voltage	-0.5	36	Vdc
V _{ISO}	Input to output isolation	500		Vdc
W _{tr}	Transient input energy ²⁾		0.6	Ws
V _{RC}	Remote control voltage pin 1	0	5	Vdc

Stress in excess of Absolute Maximum Ratings may cause permanent damage. Absolute Maximum Ratings, sometimes referred to as no destruction limits, are normally tested with one parameter at a time exceeding the limits of Output data or Electrical Characteristics. If exposed to stress above these limits, function and performance may degrade in an unspecified manner.

Safety

The PKC 2000 I DC/DC power modules are designed in accordance with EN 60 950. *Safety of information technology equipment including electrical business equipment.* and certified by SEMKO.

The isolation is an operational insulation in accordance with EN 60950. The PKC power modules are recognized by UL and meet the applicable requirements in UL 1950 *Safety of information technology equipment*, the applicable *canadian safety requirements* and UL 1012 standard for power supplies. The DC/DC power module shall be installed in an end-use equipment.

The isolation voltage between input and output and between case and input/output is 500 Vdc and the capacitor between the input and output has a value of 10 nF. The leakage current is less than 1uA @ 26 Vdc.

The case is partly designed in non-conductive plastic. Flammability ratings meets UL 94V-0.

Input T_C < T_{Cmax} unless otherwise specified

Characteristics		Conditions	min	typ	max	Unit
V _I	Input voltage range ³⁾		18		36	V
V _{Ioff}	Turn-off input voltage	(See Operating Information)	13		17	V
V _{Ion}	Turn-on input voltage	(See Operating Information)	14		18	V
r _{trush}	Equivalent inrush current resistance			600		mΩ
C _I	Input capacitance			1.4		μF
P _{li}	Input idling power	I _O = 0, T _C = 0...+95 °C		2		W
P _{RC}	Input stand-by power	V _I = 26V, I _O = 0, T _C = 0...+95 °C, RC connected to pin 3		0.6		W

Environmental Characteristics

Characteristics	Test procedure & conditions		
Vibration (Sinusoidal)	IEC 68-2-6 F _C	Frequency Amplitude Acceleration Number of cycles	10...500 Hz 0.75 mm 10 g 10 in each axis
Shock (Half sinus)	IEC 68-2-27 E _a	Peak acceleration Shock duration	200 g 3 ms
Bump (Half sinus)	IEC 68-2-29 E _b	Peak acceleration Bump duration Number of bumps	40 g 6 ms 1000 in 6 directions
Temperature change	IEC 68-2-14 N _a	Temperature Number of cycles	-40°C...+125°C 10
Damp heat	IEC 68-2-3 C _a	Temperature Duration	40°C 56 days
Accelerated damp heat	IEC 68-2-3 C _a with bias	Temperature Humidity Duration	85°C 85% RH 500 hours
Solder resistability	IEC 68-2-20 T _b 1A	Temperature, solder Duration	260°C 10...13 s

Notes:

- 1) Corresponding ambient temp. range (T_A) at full output power is -45 to +85°C.
- 2) P < 1 kW, t_r/t_d = 10/1000 ms, I_I < 8 A. Transient suppressor threshold voltage is 39 V typ.
- 3) The converters will operate down to V_I ≤ 17 V, when V_I decreases, but will turn on at V_I ≤ 18 V, when V_I increases (see also Operating information).

Mechanical Data

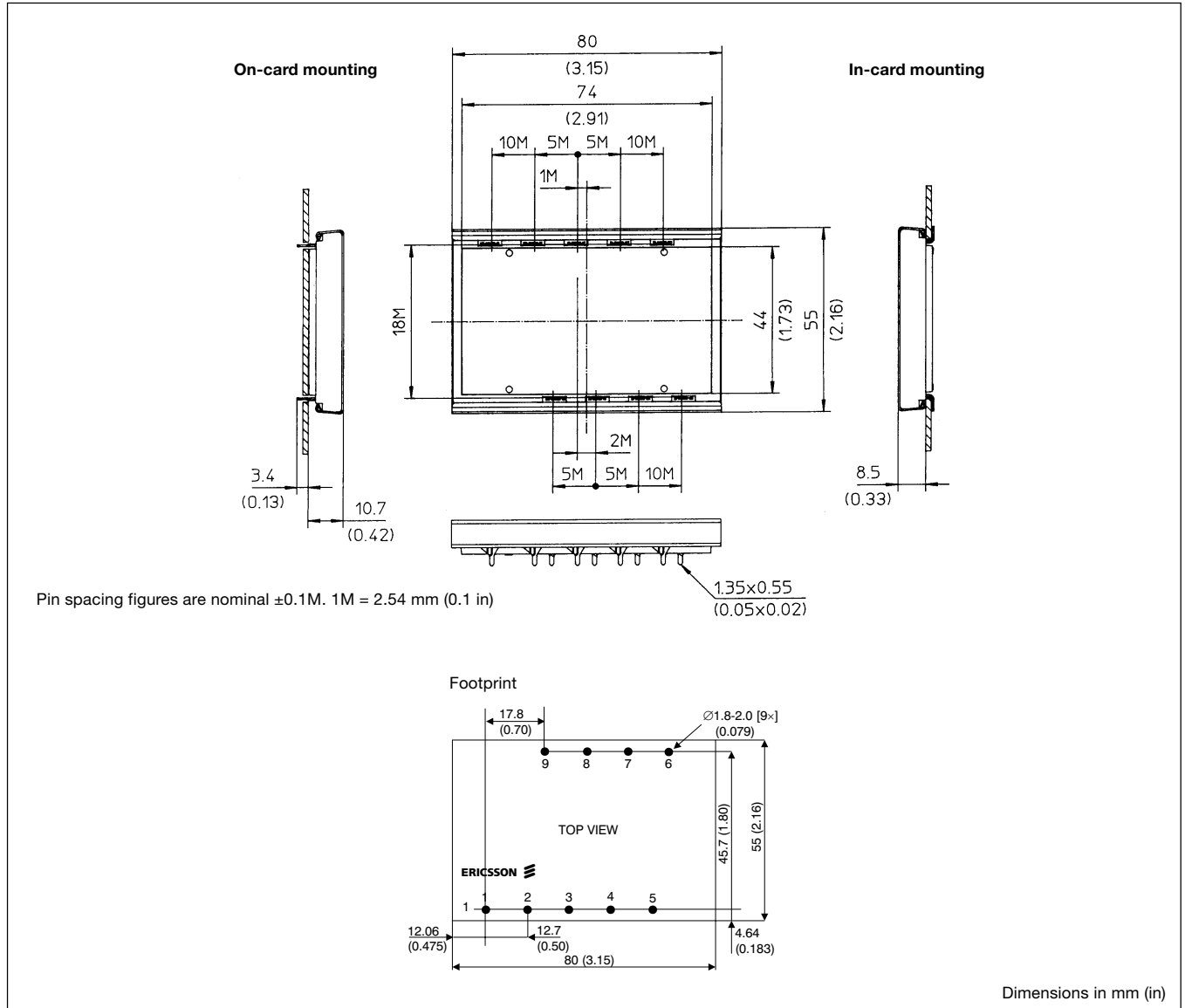

Connections

Pin	Designation	Function
1	RC	Remote Control to turn-on and turn-off the output. It is also used to adjust the turn-off input voltage threshold (see V_{loff} p.15)
2	NC	The pin is Not Connected
3	-In	Negative Input terminal
4	+In	Positive Input terminal
5	Aux	Auxiliary terminal (see V_{loff} p. 15)
6	Out	Negative Output terminal. Output 2 in dual and Output 3 in triple output models
7	Out	Positive Output terminal. Output 2 in triple output models. Additional return in dual versions
8	Rtn	Return terminal for all outputs
9	Out	Positive Output terminal. Output 1 in all models

Weight

50 gr (1.76 oz).

Case

Blue anodized aluminum case with a plastic bottom cover and with tin plated brass pins.

Thermal Data

Two-parameter model

Power dissipation is generated in the components mounted on the ceramic substrate. The thermal properties of the PKC power module is determined by thermal conduction in the connected pins and thermal convection from the substrate via the case.

The two-parameter model characterize the thermal properties of the PKC power module and the equation below can be used for thermal design purposes if detailed information is needed. The values are given for a module mounted on a printed board assembly (PBA).

Note that the thermal resistance between the substrate and the air, $R_{th\ sub-A}$ is strongly dependent on the air velocity.

$$T_{sub} = P_d \times R_{th\ sub-P} \times R_{th\ sub-A} / (R_{th\ sub-P} + R_{th\ sub-A}) + (T_P - T_A) \times R_{th\ sub-A} / (R_{th\ sub-P} + R_{th\ sub-A}) + T_A$$

Where:

P_d : dissipated power, calculated as $P_O \times (1/\eta - 1)$.

T_{sub} : max average substrate temperature, $\approx T_{Cmax}$.

T_A : ambient air temperature at the lower side of the power module.

T_P : average pin temperature or solder joint temperature.

$R_{th\ sub-P}$: thermal resistance from T_{sub} to the pins.

$R_{th\ sub-A}$: thermal resistance from T_{sub} to T_A .

v : velocity of ambient air.

Air velocity in free convection is 0.2–0.3 m/s (40-60 lfm).

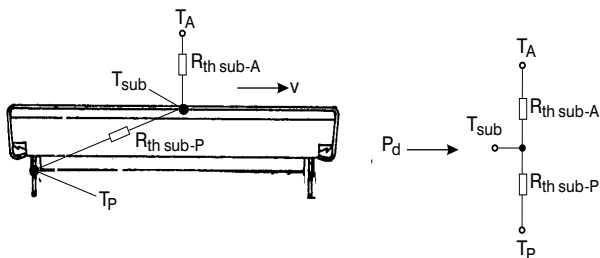
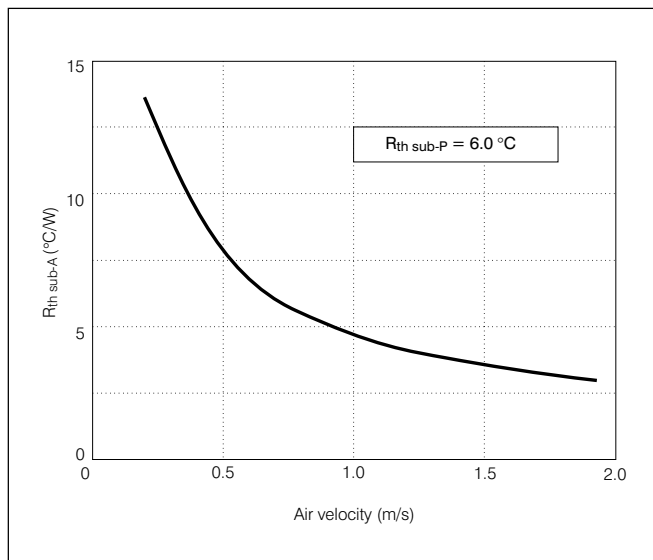

Electrical Data

Fundamental circuit diagrams

Single output

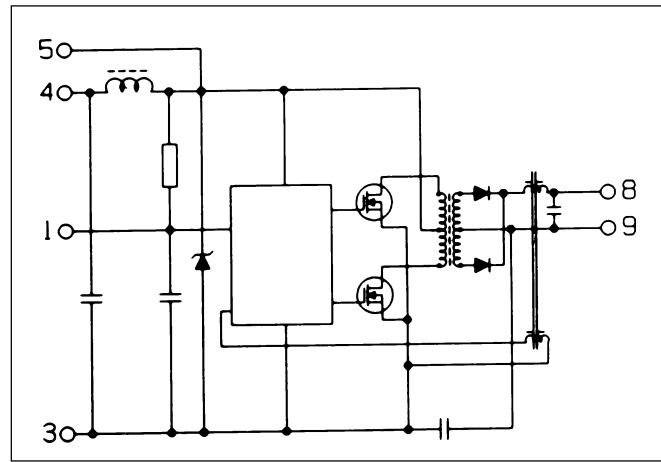

Dual output

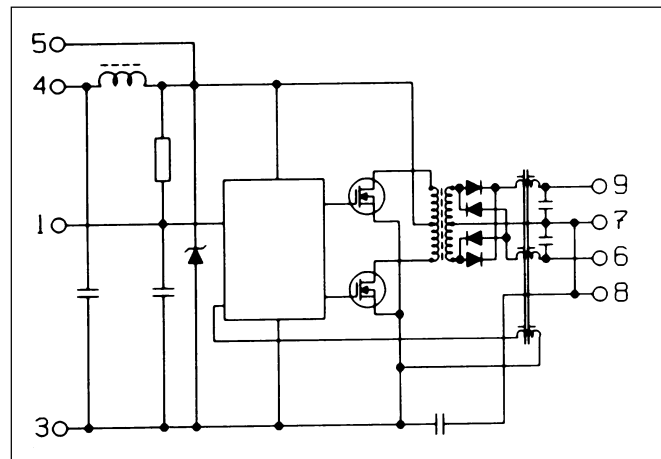

Triple output

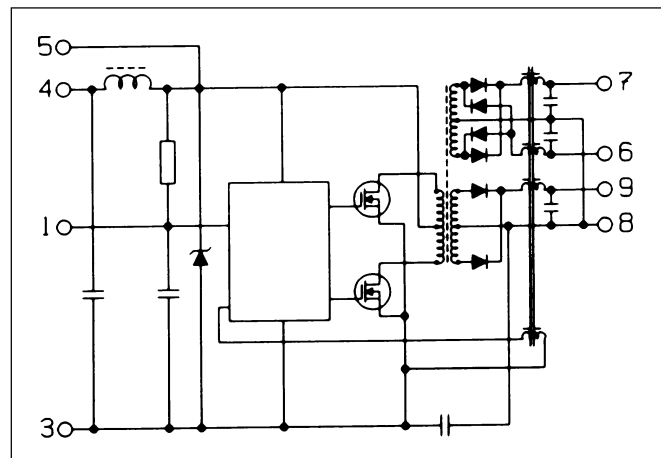

PKC 2111 PI

$T_C = 0 \dots +95^\circ\text{C}$, $V_I = 18 \dots 36 \text{ V}$ unless otherwise specified.

Output

Characteristics		Conditions	Output 1			Unit
			min	typ	max	
V_{O_i}	Output voltage initial setting and accuracy	$T_C = +25^\circ\text{C}$, $I_O = 3 \text{ A}$, $V_I = 26 \text{ V}$	5.02	5.06	5.11	V
V_O	Output voltage tolerance band	$I_O = 0.1 \dots 1.0 \times I_{O_{\text{max}}}$ and long term drift	4.90		5.25	V
	Idling circuit voltage	$I_O = 0 \text{ A}$			5.25	V
	Line regulation	$I_O = I_{O_{\text{max}}}$			90	mV
	Load regulation	$I_O = 0.1 \dots 1.0 \times I_{O_{\text{max}}}$, $V_I = 26 \text{ V}$			150	mV
t_{tr}	Load transient recovery time	$I_O = 0.1 \dots 1.0 \times I_{O_{\text{max}}}$, $V_I = 26 \text{ V}$ load step = 2.4 A $\frac{di}{dt} < 1 \text{ A}/\mu\text{s}$		100		μs
V_{tr}	Load transient voltage		+250			mV
			-250			mV
	Short term drift	$t = 0 \dots 10 \text{ minutes}$		-15		mV
T_{coeff}	Temperature coefficient	$I_O = I_{O_{\text{max}}}$, $T_C < T_{C_{\text{max}}}$		-0.5		$\text{mV}/^\circ\text{C}$
t_r	Ramp-up time	$I_O = 0.1 \dots 1.0 \times I_{O_{\text{max}}}$, $V_I = 26 \text{ V}$	$0.1 \dots 0.9 \times V_O$		20	ms
t_s	Start-up time		From V_I connection to $V_O = 0.9 \times V_{O_i}$		30	ms
I_O	Output current		0		3.0	A
$P_{O_{\text{max}}}$	Max output power	*	15			W
I_{lim}	Current limiting threshold	$T_C < T_{C_{\text{max}}}$	3.1			A
I_{sc}	Short circuit current	$V_O = 0.2 \dots 0.5 \text{ V}$, $T_A = 25^\circ\text{C}$ Hick-up		<0.5		A
$V_{O_{\text{ac}}}$	Output ripple & noise	$I_O = I_{O_{\text{max}}}$	20 Hz ... 5 MHz		100	$\text{mV}_{\text{p-p}}$
			DC ... 50 MHz		120	$\text{mV}_{\text{p-p}}$
			1 MHz bandwidth		35	mV_{rms}
SVR	Supply voltage rejection (ac)	$f = 100 \text{ Hz}$ sine wave, $1 \text{ V}_{\text{p-p}}$, $V_I = 26 \text{ V}$ ($\text{SVR} = 20 \log(1 \text{ V}_{\text{p-p}}/V_{O_{\text{p-p}}})$)	50			dB

* See also Power derating p. 12

Miscellaneous

Characteristics		Conditions	min	typ	max	Unit
η	Efficiency	$I_O = I_{O_{\text{max}}}$, $V_I = 26 \text{ V}$	80.5	81.5		%
P_d	Power dissipation	$I_O = I_{O_{\text{max}}}$		3.4		W

PKC 2113 PI

$T_C = 0...+95^{\circ}\text{C}$, $V_I = 18...36\text{V}$ unless otherwise specified.

Output

Characteristics		Conditions	Output 1			Unit
			min	typ	max	
V_{O_i}	Output voltage initial setting and accuracy	$T_C = +25^{\circ}\text{C}$, $I_O = 1.5\text{A}$, $V_I = 26\text{V}$	11.94	12.00	12.06	V
V_O	Output voltage tolerance band	$I_O = 0.1 \dots 1.0 \times I_{O\text{max}}$ and long term drift	11.80		12.35	V
	Idling circuit voltage	$I_O = 0\text{A}$			12.40	V
	Line regulation	$I_O = I_{O\text{max}}$			168	mV
	Load regulation	$I_O = 0.1 \dots 1.0 \times I_{O\text{max}}$, $V_I = 26\text{V}$			360	mV
t_{tr}	Load transient recovery time	$I_O = 0.1 \dots 1.0 \times I_{O\text{max}}$, $V_I = 26\text{V}$ load step = 1.2 A $\frac{di}{dt} < 1\text{A}/\mu\text{s}$		200		μs
V_{tr}	Load transient voltage		+600			mV
			-600			mV
	Short term drift	$t = 0 \dots 10\text{minutes}$		-45		mV
T_{coeff}	Temperature coefficient	$I_O = I_{O\text{max}}$, $T_C < T_{C\text{max}}$		-1.5		mV/ $^{\circ}\text{C}$
t_r	Ramp-up time	$I_O = 0.1 \dots 1.0 \times I_{O\text{max}}$, $V_I = 26\text{V}$	$0.1 \dots 0.9 \times V_O$	20		ms
t_s	Start-up time		From V_I connection to $V_O = 0.9 \times V_{O_i}$		30	
I_O	Output current		0		1.5	A
$P_{O\text{max}}$	Max output power	*	18			W
I_{lim}	Current limiting threshold	$T_C < T_{C\text{max}}$	1.6			A
I_{sc}	Short circuit current	$V_O = 0.2 \dots 0.5\text{V}$, $T_A = 25^{\circ}\text{C}$ Hick-up		<0.5		A
$V_{O\text{ac}}$	Output ripple & noise	$I_O = I_{O\text{max}}$	20 Hz... 5 MHz		80	mV _{p-p}
			DC... 50 MHz		100	mV _{p-p}
			1 MHz bandwidth		25	mV _{rms}
SVR	Supply voltage rejection (ac)	$f = 100\text{Hz}$ sine wave, 1V_{p-p} , $V_I = 26\text{V}$ (SVR = $20 \log(1 \text{V}_{p-p}/\text{V}_{O\text{p-p}})$)	43			dB

* See also Power derating p. 12

Miscellaneous

Characteristics		Conditions	min	typ	max	Unit
η	Efficiency	$I_O = I_{O\text{max}}$, $V_I = 26\text{V}$	84	85		%
P_d	Power dissipation	$I_O = I_{O\text{max}}$		3.2		W

PKC 2121 PI

$T_C = 0...+95^{\circ}\text{C}$, $V_I = 18...36\text{V}$ unless otherwise specified. $I_{O1nom} = 0.75\text{A}$, $I_{O2nom} = 0.75\text{A}$

Output

Characteristics		Conditions	Output 1			Output 2			Unit
			min	typ	max	min	typ	max	
V_{O1}	Output voltage initial setting and accuracy	$T_C = +25^{\circ}\text{C}$, $I_O = I_{Onom}$, $V_I = 26\text{V}$	11.91	12.00	12.09	-11.84	-12.00	-12.16	V
V_O	Output voltage tolerance band	$I_{O1} = 0.1... 1.0 \times I_{Onom}$, $I_{O2} = I_{Onom}$ and long term drift	11.75		12.35	11.64		12.36	V
	Idling circuit voltage	$I_O = 0\text{A}$			12.40	15 20		V	
	Line regulation	$I_O = I_{Onom}$			120	144		mV	
	Load regulation	$I_{O1} = 0.1... 1.0 \times I_{Onom}$, $I_{O2} = I_{Onom}$, $V_I = 26\text{V}$			360			mV	
t_{tr}	Load transient recovery time	$I_O = 0.1... 1.0 \times I_{Onom}$, $V_I = 26\text{V}$ load step = 0.6 A symmetrical load, $I_{O1} = I_{O2}$	200		200		μs		
V_{tr}	Load transient voltage	$\frac{di}{dt} < 1\text{A}/\mu\text{s}$	+600		+600		mV		
			-600		-600		mV		
	Short term drift	$t = 0...10\text{ minutes}$	-30		-30		mV		
T_{coeff}	Temperature coefficient	$I_O = I_{Onom}$, $T_C < T_{Cmax}$	-1.0		-1.0		mV/ $^{\circ}\text{C}$		
t_r	Ramp-up time	$I_O = 0.1... 1.0 \times I_{Onom}$, $V_I = 26\text{V}$	0.1... 0.9 $\times V_O$		20		20		ms
t_s	Start-up time		From V_I connection to $V_O = 0.9 \times V_{O1}$		30		30		ms
I_O	Output current		0	1.2		0	1.2		A
P_{Omax}	Max total output power	*	min 18					W	
I_{lim}	Current limiting threshold	$T_C < T_{Cmax}$	min $1.02 \times P_{Omax}$ **						
I_{sc}	Short circuit current	$V_O = 0.2... 0.5\text{V}$, $T_A = 25^{\circ}\text{C}$ Hick-up	<0.5		<0.5		A		
V_{Oac}	Output ripple & noise	$I_O = I_{Onom}$	20 Hz... 5 MHz		90		90		mV $_{p-p}$
			DC... 50 MHz		110		110		mV $_{p-p}$
			1 MHz bandwidth		25		30		mV $_{rms}$
SVR	Supply voltage rejection (ac)	$f = 100\text{ Hz sine wave}$, $1 V_{p-p}$, $V_I = 26\text{V}$ (SVR = $20 \log(1 V_{p-p}/V_{O p-p})$)	43		43		dB		

* See also Power derating p. 12

** I_{lim} on each output is set by the total load

Miscellaneous

Characteristics		Conditions	min	typ	max	Unit
η	Efficiency	$I_O = I_{Onom}$, $V_I = 26\text{V}$	84	86		%
P_d	Power dissipation	$I_O = I_{Onom}$		2.9		W

PKC 2126 PI

$T_C = 0...+95^{\circ}\text{C}$, $V_I = 18...36\text{V}$ unless otherwise specified. $I_{O1nom} = 0.6\text{A}$, $I_{O2nom} = 0.6\text{A}$

Output

Characteristics		Conditions	Output 1			Output 2			Unit
			min	typ	max	min	typ	max	
V_{O_i}	Output voltage initial setting and accuracy	$T_C = +25^{\circ}\text{C}$, $I_O = I_{Onom}$, $V_I = 26\text{V}$	14.89	15.0	15.11	-14.82	-15.0	-15.18	V
V_O	Output voltage tolerance band	$I_{O1} = 0.1... 1.0 \times I_{O1nom}$, $I_{O2} = I_{O2nom}$ and long term drift	14.70		15.40	14.55		15.45	V
	Idling voltage	$I_O = 0\text{A}$			15.45	18 23		V	
	Line regulation	$I_O = I_{Onom}$			240	270		mV	
	Load regulation	$I_{O1} = 0.1... 1.0 \times I_{O1nom}$, $I_{O2} = I_{O2nom}$, $V_I = 26\text{V}$			450			mV	
t_{tr}	Load transient recovery time	$I_O = 0.1... 1.0 \times I_{Onom}$, $V_I = 26\text{V}$ load step = 0.48 A symmetrical load, $I_{O1} = I_{O2}$	250			250		μs	
V_{tr}	Load transient voltage	$\frac{di}{dt} < 1\text{A}/\mu\text{s}$	+750			+750		mV	
			-750			-750		mV	
	Short term drift	$t = 0...10\text{minutes}$	-30			-30		mV	
T_{coeff}	Temperature coefficient	$I_O = I_{Onom}$, $T_C < T_{Cmax}$	-1.0			-1.0		$\text{mV}/^{\circ}\text{C}$	
t_r	Ramp-up time	$I_O = 0.1... 1.0 \times I_{Onom}$, $V_I = 26\text{V}$	0.1 ... 0.9 $\times V_O$		20		20	ms	
t_s	Start-up time		From V_I connection to $V_O = 0.9 \times V_{O_i}$		30		30	ms	
I_O	Output current		0	1.0		0	1.0		A
P_{Omax}	Max total output power	*	min 18					W	
I_{lim}	Current limiting threshold	$T_C < T_{Cmax}$	min $1.02 \times P_{Omax}$ **						
I_{sc}	Short circuit current	$V_O = 0.2... 0.5\text{V}$, $T_A = 25^{\circ}\text{C}$ Hick-up	<0.5		<0.5		A		
V_{Oac}	Output ripple & noise	$I_O = I_{Onom}$	20 Hz... 5 MHz		90		90		mV_{p-p}
			DC... 50 MHz		110		110		mV_{p-p}
			1 MHz bandwidth		25		30		mV_{rms}
SVR	Supply voltage rejection (ac)	$f = 100\text{Hz}$ sine wave, 1V_{p-p} , $V_I = 26\text{V}$ ($\text{SVR} = 20 \log(1\text{V}_{p-p}/V_{O(p-p)})$)	40		40		dB		

* See also Power derating p. 12

** I_{lim} on each output is set by the total load

Miscellaneous

Characteristics		Conditions	min	typ	max	Unit
η	Efficiency	$I_O = I_{Onom}$, $V_I = 26\text{V}$	84	86.5		%
P_d	Power dissipation	$I_O = I_{Onom}$	2.8			W

PKC 2131 PI

$T_C = 0...+95^{\circ}\text{C}$, $V_I = 18...36\text{V}$ unless otherwise specified. $I_{O1\text{nom}} = 2.0\text{A}$, $I_{O2,3\text{nom}} = 0.2\text{A}$

Output

Characteristics		Conditions	Output 1			Output 2			Output 3			Unit				
			min	typ	max	min	typ	max	min	typ	max					
V_{O1}	Output voltage initial setting and accuracy	$T_C = +25^{\circ}\text{C}$, $I_O = I_{O\text{nom}}$, $V_I = 26\text{V}$		5.02	5.06	5.11	11.94	12.10	12.26	-11.94	-12.10	-12.26	V			
V_O	Output voltage tolerance band	$I_O = 0.1 \dots 1.0 \times I_{O\text{nom}}$, $I_{O2,3} = I_{O\text{nom}}$ and long term drift		4.90		5.25	11.64		12.36	11.64		12.36	V			
	Idling voltage	$I_O = 0\text{A}$				5.25	15.00		16.80	15.00		16.80	V			
	Line regulation	$I_O = I_{O\text{nom}}$				81			288			288	mV			
	Load regulation	$I_{O1} = 0.1 \dots 1.0 \times I_{O\text{nom}}$, $I_{O2,3} = I_{O\text{nom}}$, $V_I = 26\text{V}$				162							mV			
t_{tr}	Load transient recovery time	$I_O = 0.1 \dots 1.0 \times I_{O\text{nom}}$, $V_I = 26\text{V}$ load step = 80% of $I_{O\text{nom}}$				100			200			200	μs			
V_{tr}	Load transient voltage	$\frac{di}{dt} < 1\text{A}/\mu\text{s}$				+250			+600			+600	mV			
						-250			-600			-600	mV			
	Short term drift	$t = 0...10\text{minutes}$				-15			-36			-36	mV			
T_{coeff}	Temperature coefficient	$I_O = I_{O\text{nom}}$, $T_C < T_{C\text{max}}$				-0.5			-1.2			-1.2	$\text{mV}/^{\circ}\text{C}$			
t_r	Ramp-up time	$I_O = 0.1 \dots 1.0 \times I_{O\text{nom}}$, $V_I = 26\text{V}$	$0.1 \dots 0.9 \times V_O$			20			20			20	ms			
t_s	Start-up time	$V_I = 26\text{V}$	From V_I connection to $V_O = 0.9 \times V_{O1}$			30			30			30	ms			
I_O	Output current			0		3.0	0		0.6	0		0.6	A			
$P_{O\text{max}}$	Max total output power	*		min 15								W				
I_{lim}	Current limiting threshold	$T_C < T_{C\text{max}}$		min $1.02 \times P_{O\text{max}}$ **												
I_{sc}	Short circuit current	$V_O = 0.2 \dots 0.5\text{V}$, $T_A = 25^{\circ}\text{C}$ Hick-up		<0.5			<0.5			<0.5			A			
$V_{O\text{ac}}$	Output ripple & noise	$I_O = I_{O\text{nom}}$		20 Hz... 5 MHz			100			110			100			$\text{mV}_{\text{p-p}}$
				DC... 50 MHz			130			150			150			$\text{mV}_{\text{p-p}}$
				1 MHz bandwidth			40			40			40			mV_{rms}
SVR	Supply voltage rejection (ac)	$f = 100\text{Hz}$ sine wave, $1 V_{\text{p-p}}$, $V_I = 26\text{V}$ ($\text{SVR} = 20 \log(1 V_{\text{p-p}}/V_{O\text{p-p}})$)		50			43			43			dB			

* See also Power derating p. 13. Max output power on output 2 and 3 jointly is min 10 W

** I_{lim} on each output is set by the total load

Miscellaneous

Characteristics		Conditions	min	typ	max	Unit
η	Efficiency	$I_O = I_{O\text{nom}}$, $V_I = 26\text{V}$	79.5	81		%
P_d	Power dissipation	$I_O = I_{O\text{nom}}$		3.5		W

PKC 2132 PI

$T_C = 0...+95^{\circ}\text{C}$, $V_I = 18...36\text{V}$ unless otherwise specified. $I_{O1\text{nom}} = 2.0\text{A}$, $I_{O2,3\text{nom}} = 0.17\text{A}$

Output

Characteristics		Conditions	Output 1			Output 2			Output 3			Unit			
			min	typ	max	min	typ	max	min	typ	max				
V_{O1}	Output voltage initial setting and accuracy	$T_C = +25^{\circ}\text{C}$, $I_O = I_{O\text{nom}}$, $V_I = 26\text{V}$	5.03	5.06	5.10	14.80	15.00	15.20	-14.80	-15.00	-15.20	V			
V_O	Output voltage tolerance band	$I_O = 0.1... 1.0 \times I_{O\text{nom}}$, $I_{O2,3} = I_{O\text{nom}}$ and long term drift	4.90		5.25	14.40		15.60	14.40		15.60	V			
	Idling voltage	$I_O = 0\text{A}$			5.25	18.00		19.80	18.00		19.80	V			
	Line regulation	$I_O = I_{O\text{nom}}$			81			330			330	mV			
	Load regulation	$I_{O1} = 0.1... 1.0 \times I_{O\text{nom}}$, $I_{O2,3} = I_{O\text{nom}}$, $V_I = 26\text{V}$			182							mV			
t_{tr}	Load transient recovery time	$I_O = 0.1... 1.0 \times I_{O\text{nom}}$, $V_I = 26\text{V}$ load step = 80% of $I_{O\text{nom}}$		100			250			250		μs			
V_{tr}	Load transient voltage	$\frac{di}{dt} < 1\text{A}/\mu\text{s}$		+250			+750			+750		mV			
				-250			-750			-750		mV			
	Short term drift	$t = 0...10\text{minutes}$		-15			-45			-45		mV			
T_{coeff}	Temperature coefficient	$I_O = I_{O\text{nom}}$, $T_C < T_{C\text{max}}$		-0.5			-1.5			-1.5		$\text{mV}/^{\circ}\text{C}$			
t_r	Ramp-up time	$I_O = 0.1... 1.0 \times I_{O\text{nom}}$, $V_I = 26\text{V}$		20			20			20		ms			
t_s	Start-up time	From V_I connection to $V_O = 0.9 \times V_{O1}$		30			30			30		ms			
I_O	Output current		0		3.0	0		0.5	0		0.5	A			
$P_{O\text{max}}$	Max total output power	*	min 15									W			
I_{lim}	Current limiting threshold	$T_C < T_{C\text{max}}$	min $1.02 \times P_{O\text{max}}$ **												
I_{sc}	Short circuit current	$V_O = 0.2... 0.5\text{V}$, $T_A = 25^{\circ}\text{C}$ Hick-up	<0.5			<0.5			<0.5			A			
$V_{O\text{ac}}$	Output ripple & noise	$I_O = I_{O\text{nom}}$	20 Hz ... 5 MHz			100			110			100			$\text{mV}_{\text{p-p}}$
			DC ... 50 MHz			130			150			150			$\text{mV}_{\text{p-p}}$
			1 MHz bandwidth			40			40			40			mV_{rms}
SVR	Supply voltage rejection (ac)	$f = 100\text{Hz}$ sine wave, $1\text{V}_{\text{p-p}}$, $V_I = 26\text{V}$ ($\text{SVR} = 20 \log(1 \text{V}_{\text{p-p}}/V_{O\text{p-p}})$)	50			40			40			dB			

* See also Power derating p. 13. Max output power on output 2 and 3 jointly is min 10W

** I_{lim} on each output is set by the total load

Miscellaneous

Characteristics		Conditions	min	typ	max	Unit
η	Efficiency	$I_O = I_{O\text{nom}}$, $V_I = 26\text{V}$	80	82		%
P_d	Power dissipation	$I_O = I_{O\text{nom}}$		3.3		W

PKC 2135 PI

$T_C = 0...+95^{\circ}\text{C}$, $V_I = 18...36\text{V}$ unless otherwise specified. $I_{O1nom} = 2.0\text{A}$, $I_{O2nom} = 0.2\text{A}$, $I_{O3nom} = 0.5\text{A}$

Output

Characteristics		Conditions	Output 1			Output 2			Output 3			Unit
			min	typ	max	min	typ	max	min	typ	max	
V_{O_i}	Output voltage initial setting and accuracy	$T_C = +25^{\circ}\text{C}$, $I_O = I_{Onom}$, $V_I = 26\text{V}$	5.03	5.06	5.10	11.90	12.10	12.30	-4.99	-5.06	-5.14	V
V_O	Output voltage tolerance band	$I_O = 0.1 \dots 1.0 \times I_{Onom}$, $I_{O2,3} = I_{Onom}$ and long term drift	4.90		5.25	11.52		12.36	4.75		5.25	V
	Idling voltage	$I_O = 0\text{A}$			5.25	15.00		16.00	6.00		6.50	V
	Line regulation	$I_O = I_{Onom}$			90			336			110	mV
	Load regulation	$I_{O1} = 0.1 \dots 1.0 \times I_{Onom}$, $I_{O2,3} = I_{Onom}$, $V_I = 26\text{V}$			190							mV
t_{tr}	Load transient recovery time	$I_O = 0.1 \dots 1.0 \times I_{Onom}$, $V_I = 26\text{V}$ load step = 80% of I_{Onom}		100			200			100		μs
V_{tr}	Load transient voltage	$\frac{di}{dt} < 1\text{A}/\mu\text{s}$		+250			+600			+250		mV
				-250			-600			-250		mV
	Short term drift	$t = 0...10\text{minutes}$		-15								mV
T_{coeff}	Temperature coefficient	$I_O = I_{Onom}$, $T_C < T_{Cmax}$		-0.5			-1.0			-0.5		$\text{mV}/^{\circ}\text{C}$
t_r	Ramp-up time	$I_O = 0.1 \dots 1.0 \times I_{Onom}$, $V_I = 26\text{V}$		20			20			20		ms
t_s	Start-up time	From V_I connection to $V_O = 0.9 \times V_{O_i}$		30			30			30		ms
I_O	Output current		0	3.0		0	0.6		0	1.0		A
P_{Omax}	Max total output power	*	min 15									W
I_{lim}	Current limiting threshold	$T_C < T_{Cmax}$	min $1.02 \times P_{Omax}$ **									
I_{sc}	Short circuit current	$V_O = 0.2 \dots 0.5\text{V}$, $T_A = 25^{\circ}\text{C}$ Hick-up	<0.5			<0.5			<0.5			A
V_{Oac}	Output ripple & noise	$I_O = I_{Onom}$	20 Hz... 5 MHz		100		110		100		mV_{p-p}	
			DC... 50 MHz		130		150		120		mV_{p-p}	
			1 MHz bandwidth		40		40		35		mV_{rms}	
SVR	Supply voltage rejection (ac)	$f = 100\text{Hz}$ sine wave, 1V_{p-p} , $V_I = 26\text{V}$ ($\text{SVR} = 20 \log(1\text{V}_{p-p}/V_{O(p-p)})$)	50			43			50			dB

* See also Power derating p. 13. Max output power on output 2 and 3 jointly is min 10 W

** I_{lim} on each output is set by the total load

Miscellaneous

Characteristics		Conditions	min	typ	max	Unit
η	Efficiency	$I_O = I_{Onom}$, $V_I = 26\text{V}$	79.5	81		%
P_d	Power dissipation	$I_O = I_{Onom}$		3.5		W

PKC 2111 PI

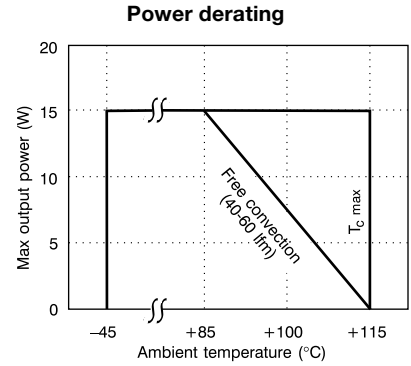
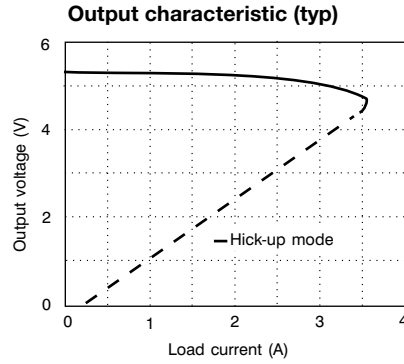
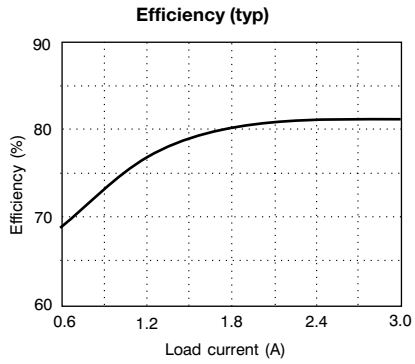

PKC 2113 PI

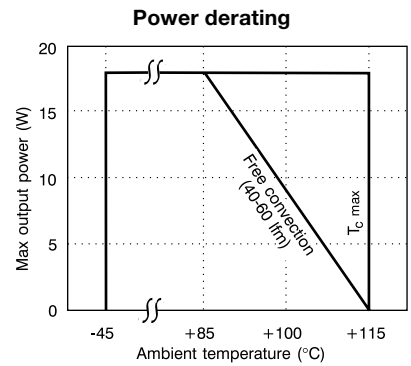
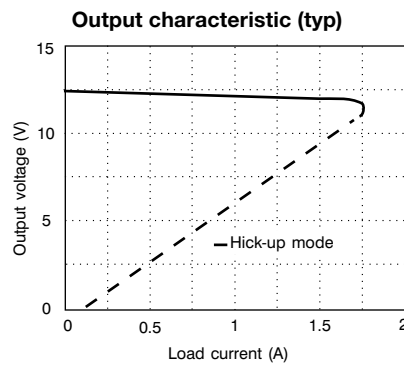
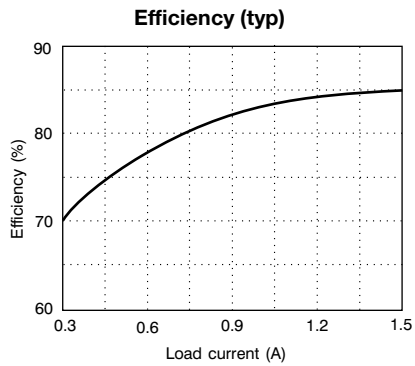

PKC 2121 PI

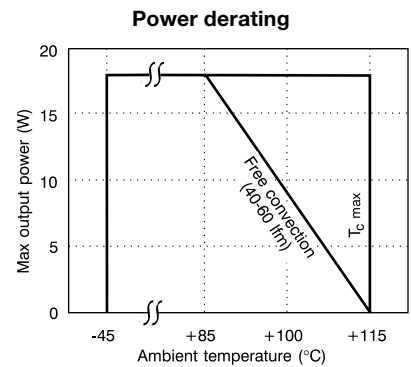
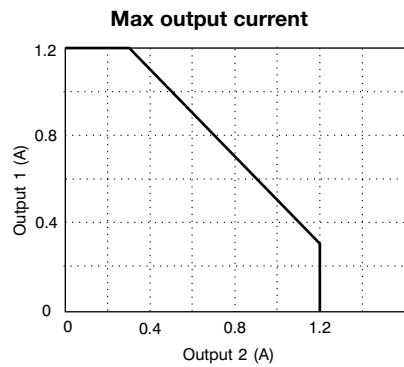
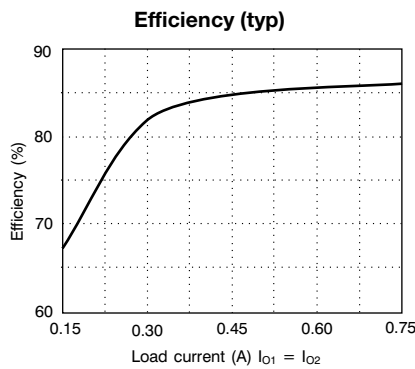

PKC 2126 PI

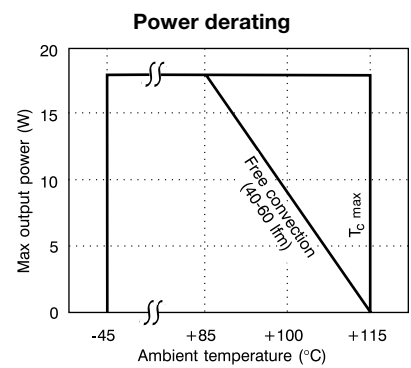
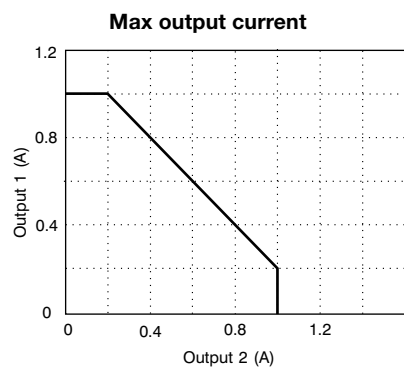
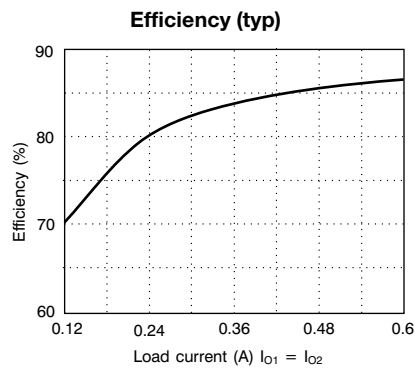

PKC 2131 PI

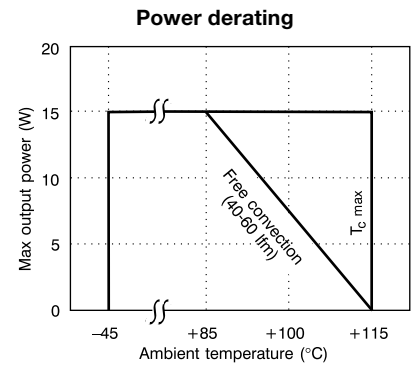
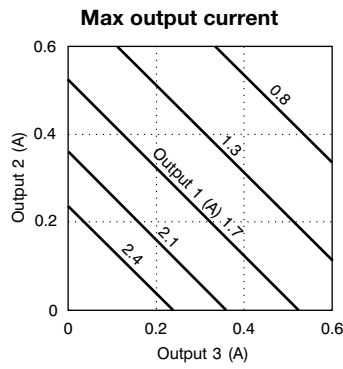
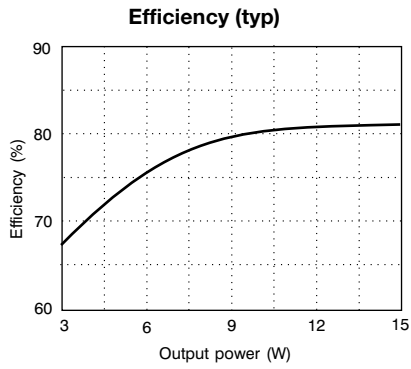

PKC 2132 PI

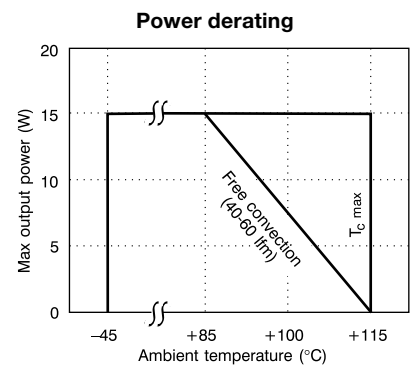
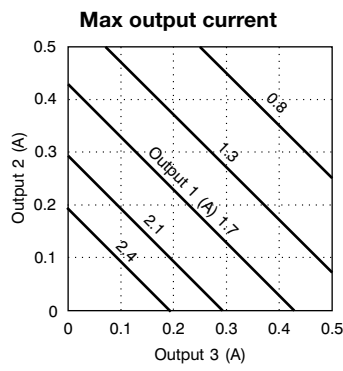
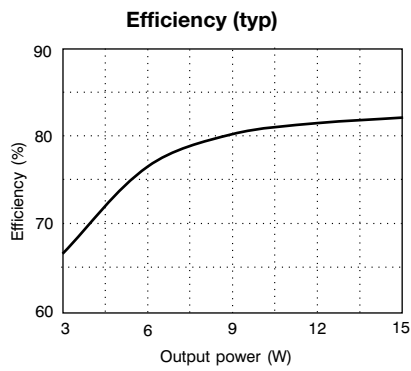

PKC 2135 PI

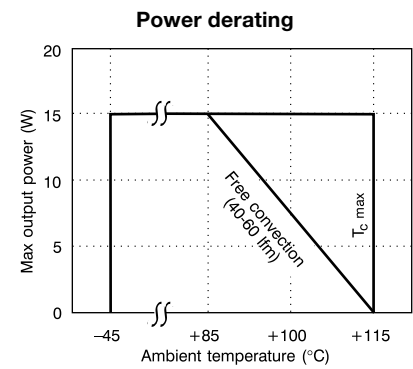
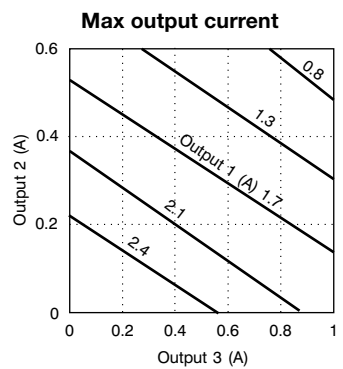
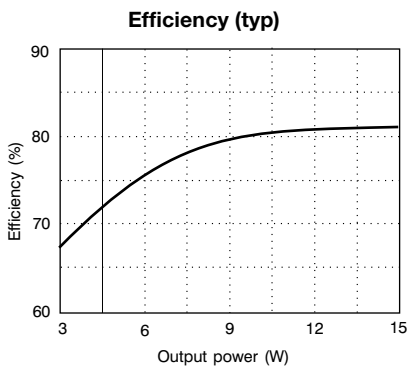

EMC Specifications

The PKC power module is mounted on a double sided printed circuit board (PB) with groundplane during EMC measurements. The fundamental switching frequency is $300 \text{ kHz} \pm 15\%$
 @ $I_O = I_{O \text{ max}}$ or $I_{O \text{ nom}}$

Conducted EMI (input terminals)

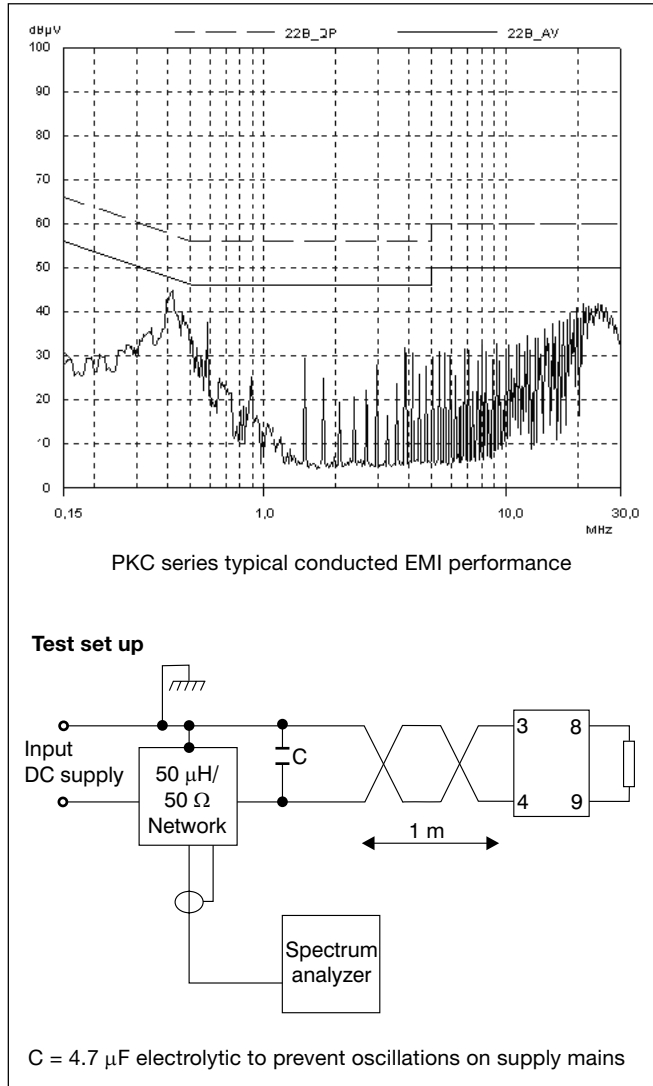

The PKC meets class A in VDE 0871/0878, FCC Part 15J, and CISPR 22 (EN 55022).

Radiated EMI

To minimize radiation it is recommended to have a ground or earth plane in the printed board (PB).

Output Ripple & Noise (V_{Oac})

Output ripple & noise is measured at the output terminals with a 50 MHz oscilloscope and a true rms DVM (crest factor >4.5). The oscilloscope's input impedance should be adapted to the impedance of the coax cable and the output terminal connection should have a minimum ground wire loop.

Operating information

Remote Control (RC)

Turn-on or turn-off can be realized by using the RC-pin. Normal operation is achieved if pin 1 is open (NC). If pin 1 is connected to pin 3 the PKC DC/DC power module turns off. To ensure safe turn-off the voltage difference between pin 1 and 3 shall be less than 1.8 V. RC is TTL open collector compatible (see fig. 1). Pin 1 is an output and no current should be driven into pin 1. Use a diode if necessary e.g. totem pole TTL logic. The internal pull-up resistance is 15 kΩ.

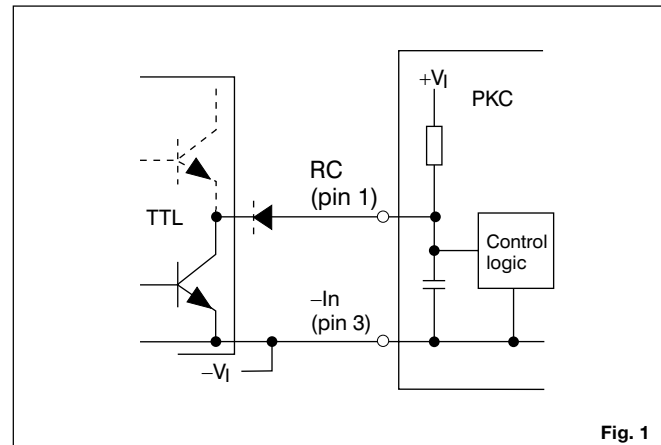

Fig. 1

Input and Output Impedance

Both the source impedance of the power feeding and the load impedance will interact with the impedance of the DC/DC power module.

It is most important to have the ratio between L and C as low as possible, i.e. a low characteristic impedance, both at the input and output, as the power modules have a low energy storage capability.

A capacitive compensation is necessary if the source or load inductance is larger than 10 µH. Use wet electrolytic capacitors. Their equivalent series resistance together with the capacitance acts as a lossless damping filter. Suitable capacitor values are in the range 10–100 µF.

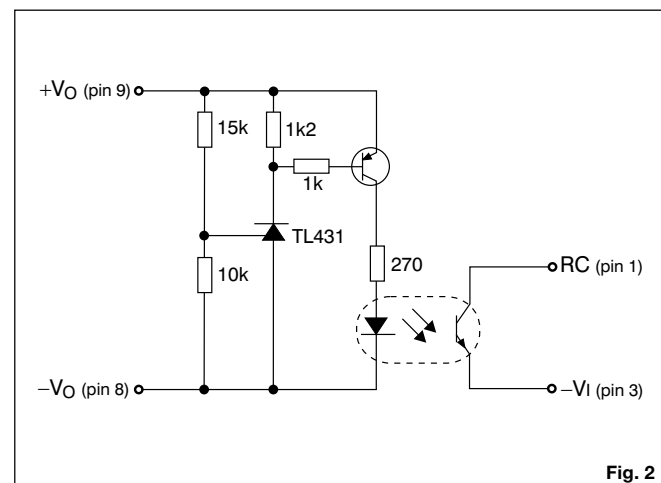

Fig. 2

Turn-off Input Voltage (V_{Ioff})

The input voltage is monitored and the PKC DC/DC power module will turn on and turn off at predetermined levels. The levels can be decreased by means of an external resistor connected between pin 1 and pin 5.

A 80 k Ω resistor will decrease the shutdown voltage below 17 V. To maintain the nominal output voltage at input voltages below V_{Imin} it may be necessary to decrease the load.

Maximum Capacitive Load

The maximum recommended capacitance connected directly to the PKC DC/DC power modules output without resistance or inductance in series is 100 μ F/A (output current rating). Connect capacitors across the load for maximum effectiveness and maximum stability margins.

Over Voltage Protection (OVP)

The remote control can be utilized also for OVP by using the external circuitry in fig. 2. Resistor values are for 5 V output applications, but can easily be adjusted for other output voltages and the desired OVP level.

Current Limiting Protection

The output power is limited at loads above the output current limiting threshold (I_{lim}), specified as a minimum value. As the PKC multiple output models are power limited, current limiting threshold for an individual output is set by the loads on the other outputs. The power module can withstand continuous short circuit without destruction. A hick-up mode is used on all models to minimize the internal power dissipation. The hick-up time constant is set by the slow start.

Quality

Reliability

Meantime between failure (MTBF) is calculated and verified by field data statistics to >2 million hours at full output power and a case temperature of 75°C, using the Ericsson failure rate data system. For more information see Design Note 002.

Quality Statement

The products are designed and manufactured in an industrial environment where quality systems and methods like ISO 9000, 6 σ and SPC, are intensively in use to boost the continuous improvements strategy. Infant mortality or early failures in the products are screened out by a burn-in procedure and an ATE-based final test.

Conservative design rules, design reviews and product qualifications, plus the high competence of an engaged work force, contribute to the high quality of our products.

Warranty

Ericsson Microelectronics warrants to the original purchaser or end user that the products conform to this Data Sheet and are free from material and workmanship defects for a period of five (5) years from the date of manufacture, if the product is used within specified conditions and not opened. In case the product is discontinued, claims will be accepted up to three (3) years from the date of the discontinuation.

For additional details on this limited warranty we refer to Ericsson Microelectronics AB's "General Terms and Conditions of Sales", or individual contract documents.

Limitation of liability

Ericsson Microelectronics does not make any other warranties, expressed or implied including any warranty of merchantability or fitness for a particular purpose (including, but not limited to, use in life support applications, where malfunctions of product can cause injury to a person's health or life).

Information given in this data sheet is believed to be accurate and reliable. No responsibility is assumed for the consequences of its use nor for any infringement of patents or other rights of third parties which may result from its use. No license is granted by implication or otherwise under any patent or patent rights of Ericsson Microelectronics. These products are sold only according to Ericsson Microelectronics' general conditions of sale, unless otherwise confirmed in writing. Specifications subject to change without notice.

Product Program

V _I	V _O /I _O max			P _O max	Ordering No.
	Output 1	Output 2	Output 3		
24 V	5 V/3 A 12 V/1.5 A			15 W 18 W	PKC 2111 PI PKC 2113 PI
	+12 V/1.2 A +15 V/1 A	-12 V/1.2 A -15 V/1 A		18 W 18 W	PKC 2121 PI PKC 2126 PI
	+5 V/3 A +5 V/3 A +5 V/3 A	+12 V/0.6 A +15 V/0.5 A +12 V/0.6 A	-12 V/0.6 A -15 V/0.5 A -5 V/1 A	15 W 15 W 15 W	PKC 2131 PI PKC 2132 PI PKC 2135 PI

Ericsson Microelectronics AB

SE-164 81 KISTA, Sweden

Phone: +46 8 757 5000

www.ericsson.com/microelectronics

For local sales contacts, please refer to our website
or call: Int. +46 8 757 4700, Fax: +46 8 757 4776

The latest and most complete information can be found on our website!

Data Sheet

EN/LZT 146 24 R1A (Replaces EN/LZT 137 01 R1)

© Ericsson Microelectronics AB, June 2000