

V_{RSM}	V_{RRM}	(dv/dt) _{cr}	I_{TRMS} (maximum value for continuous operation)			
	V_{DRM}		180 A			
V	V	V/μs	I_{TAV} (sin. 180; T _{case} = 80 °C)			
			115 A			
500	400	500	–	–	SKKH 105/04 D	–
700	600	500	SKKT 105/06 D	SKKT 106/06 D	–	SKKH 106/06 D
900	800	500	SKKT 105/08 D	SKKT 106/08 D ¹⁾	SKKH 105/08 D	SKKH 106/08 D
1300	1200	1000	SKKT 105/12 E	SKKT 106/12 E ¹⁾	SKKH 105/12 E	SKKH 106/12 E
1500	1400	1000	SKKT 105/14 E	SKKT 106/14 E ¹⁾	SKKH 105/14 E	SKKH 106/14 E
1700	1600	1000	SKKT 105/16 E	SKKT 106/16 E ¹⁾	SKKH 105/16 E	SKKH 106/16 E
1900	1800	1000	SKKT 105/18 E	SKKT 106/18 E ¹⁾	SKKH 105/18 E	SKKH 106/18 E

SEMPACK® 1 Thyristor / Diode Modules

SKKT 105 SKKH 105
SKKT 106 SKKH 106
SKKT 106B

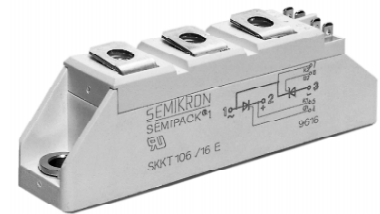

Symbol	Conditions	SKKT 105 SKKH 105	SKKT 106 SKKT 106B SKKH 106	Units
I_{TAV}	sin. 180; T _{case} = 85 °C		106	A
I_D	B2/B6 T _{amb} = 35 °C; P 3/180 F		145 / 180	A
	P 16/200 F		190 / 260	A
I_{RMS}	W1/W3 T _{amb} = 35 °C; P 3/180 F		200 / 3 x 140	A
I_{TSM}	T _{vj} = 25 °C; 10 ms		2 250	A
	T _{vj} = 130 °C; 10 ms		1 900	A
i^2t	T _{vj} = 25 °C; 8,3 ... 10 ms		25 000	A ² s
	T _{vj} = 130 °C; 8,3 ... 10 ms		18 000	A ² s
t_{gd}	T _{vj} = 25 °C; I _G = 1 A			
	di _G /dt = 1 A/μs		1	μs
t_{gr}	V _D = 0,67 · V _{DRM}		2	μs
(di/dt) _{cr}	T _{vj} = 130 °C		150	A/μs
t_q	T _{vj} = 130 °C		typ. 100	μs
I_H	T _{vj} = 25 °C; typ./max.		150 / 250	mA
I_L	T _{vj} = 25 °C; R _G = 33 Ω; typ./max.		300 / 600	mA
V_T	T _{vj} = 25 °C; I _T = 300 A		max. 1,65	V
$V_{T(TO)}$	T _{vj} = 130 °C		0,9	V
r_T	T _{vj} = 130 °C		2	mΩ
$I_{DD}; I_{RD}$	T _{vj} = 130 °C; V _{RD} = V _{RRM} V _{DD} = V _{DRM}		max. 20	mA
V_{GT}	T _{vj} = 25 °C; d.c.		3	V
I_{GT}	T _{vj} = 25 °C; d.c.		150	mA
V_{GD}	T _{vj} = 130 °C; d.c.		0,25	V
I_{GD}	T _{vj} = 130 °C; d.c.		6	mA
R_{thjc}	cont. } per thyristor / sin. 180 } per module rec. 120 }		0,28 / 0,14	°C/W
			0,30 / 0,15	°C/W
			0,32 / 0,16	°C/W
R_{thch}			0,2 / 0,1	°C/W
T_{vj}			- 40 ... + 130	°C
T_{stg}			- 40 ... + 125	°C
V_{isol}	a. c. 50 Hz; r.m.s.; 1 s/1 min		3600 / 3000	V~
M_1	to heatsink } SI (US) units		5 (44 lb. in.) ± 15 % ²⁾	Nm
M_2	to terminals }		3 (26 lb. in.) ± 15 % ²⁾	Nm
a			5 · 9,81	m/s ²
w	approx.		95	g
Case	→ page B 1 – 95	SKKT 105: A 5 SKKH 105: A 6	SKKT 106: A 46 SKKT 106B: A 48 SKKH 106: A 47	

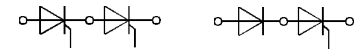

SKKT 105

SKKH 105



**SKKT 106
SKKT 106B**

SKKH 106

Features

- Heat transfer through aluminium oxide ceramic isolated metal baseplate
- Hard soldered joints for high reliability
- UL recognized, file no. E 63 532

Typical Applications

- DC motor control (e.g. for machine tools)
- AC motor soft starters
- Temperature control (e.g. for ovens, chemical processes)
- Professional light dimming (studios, theaters)

¹⁾ Also available in SKKT 106 B configuration (case A 48)

²⁾ See the assembly instructions

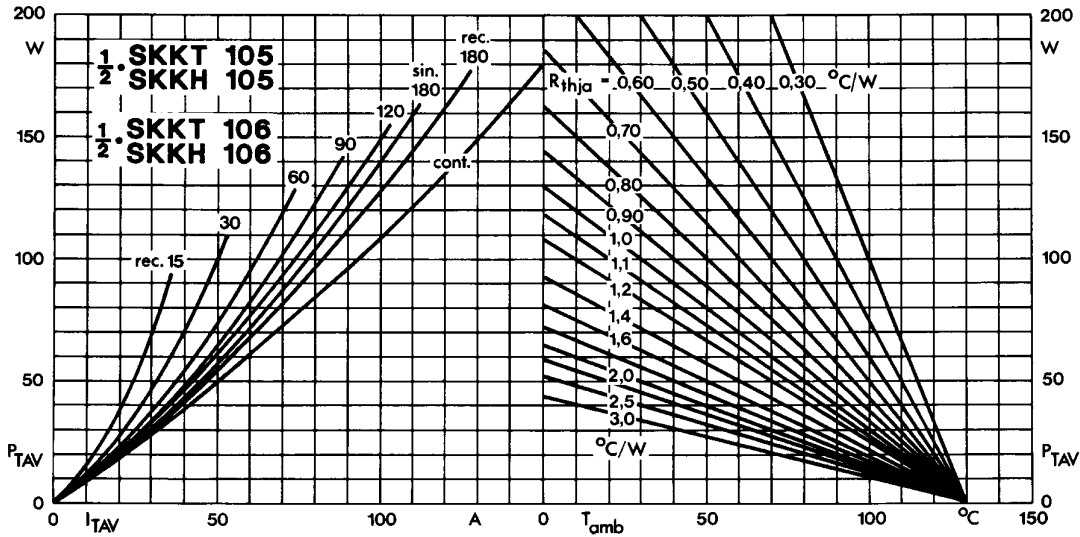

Fig. 1 Power dissipation per thyristor vs. on-state current and ambient temperature

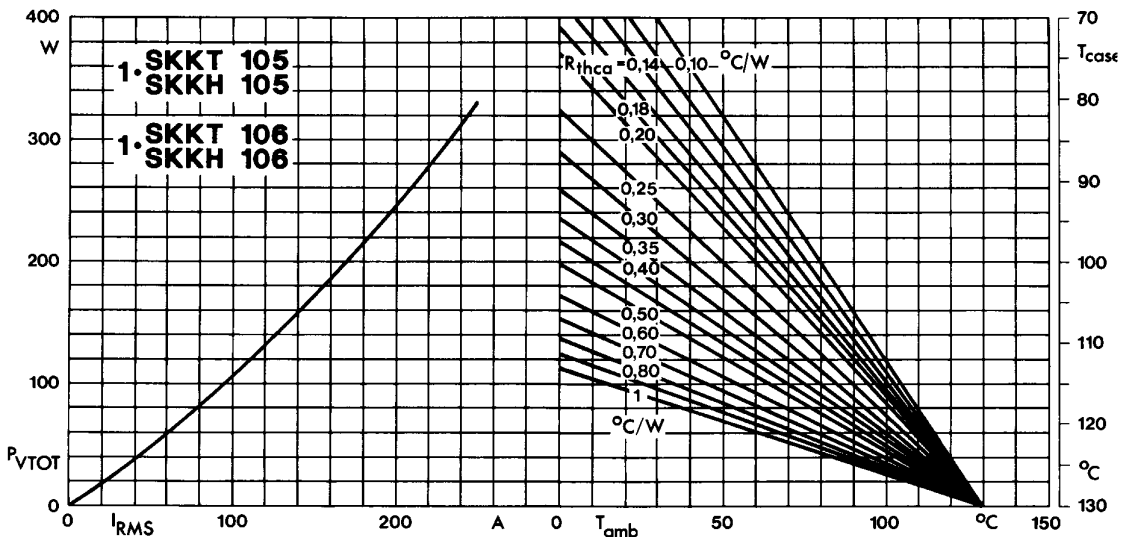

Fig. 2 Power dissipation per module vs. rms current and case temperature

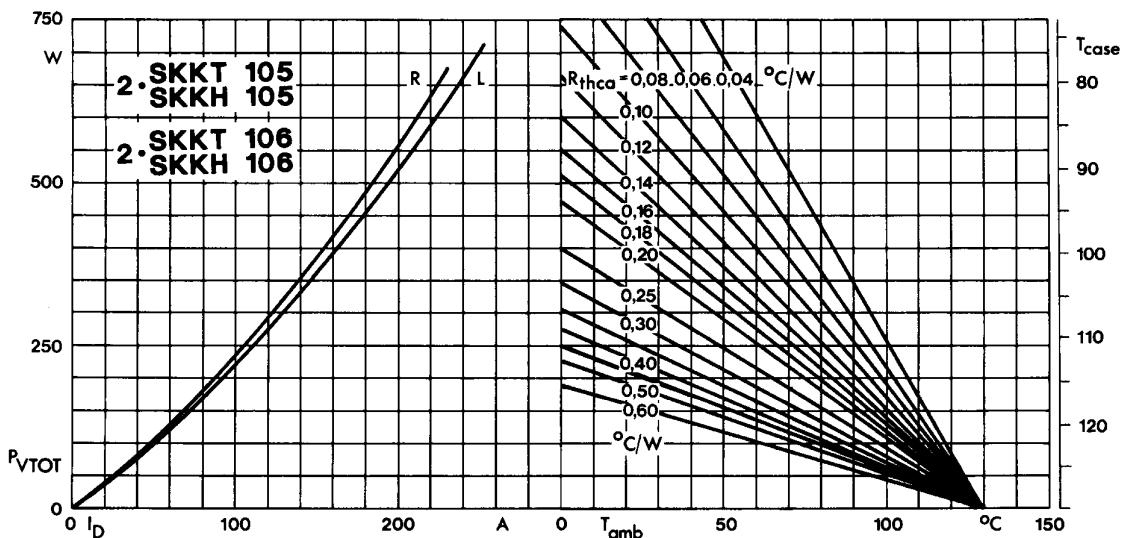

Fig. 3 Power dissipation of two modules vs. direct current and case temperature

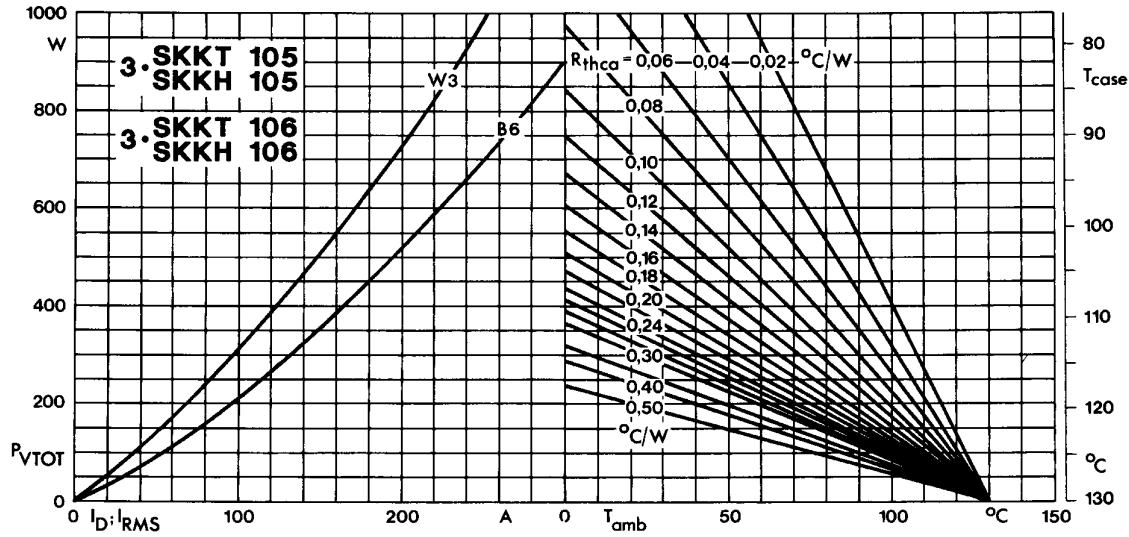

Fig. 4 Power dissipation of three modules vs. direct and rms current and case temperature

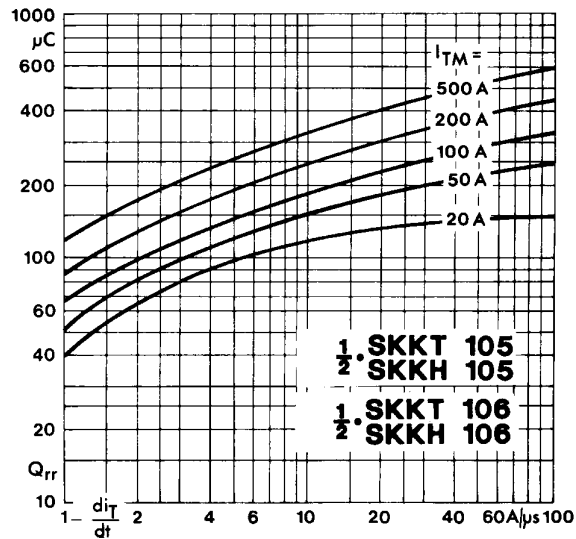

Fig. 5 Recovered charge vs. current decrease

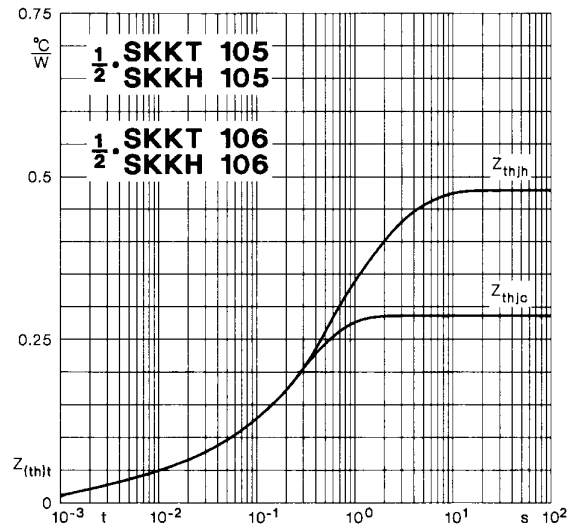

Fig. 6 Transient thermal impedance vs. time

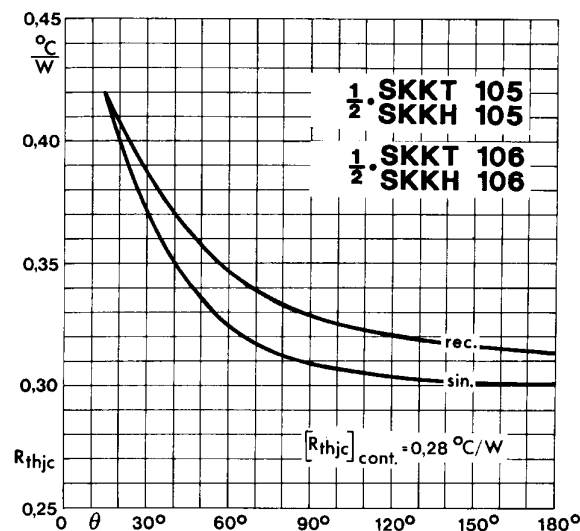

Fig. 7 Thermal resistance vs. conduction angle

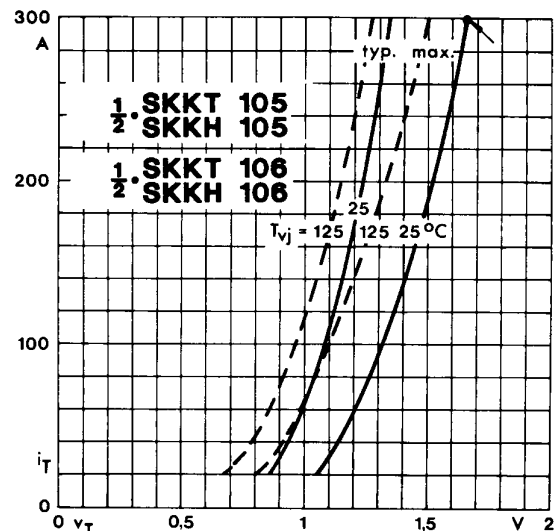

Fig. 8 On-state characteristics

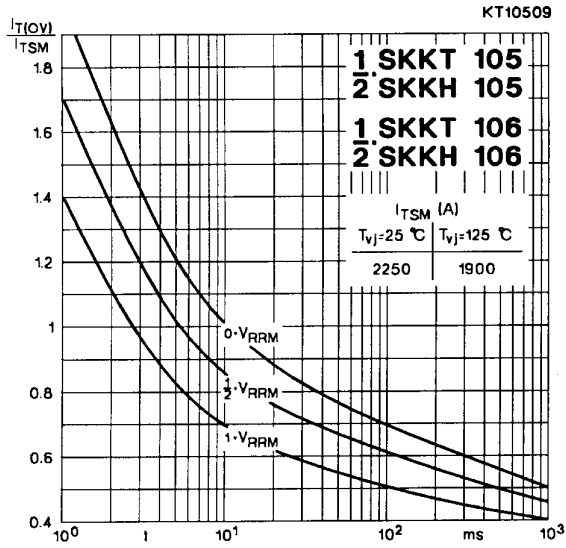

Fig. 9 Surge overload current vs. time

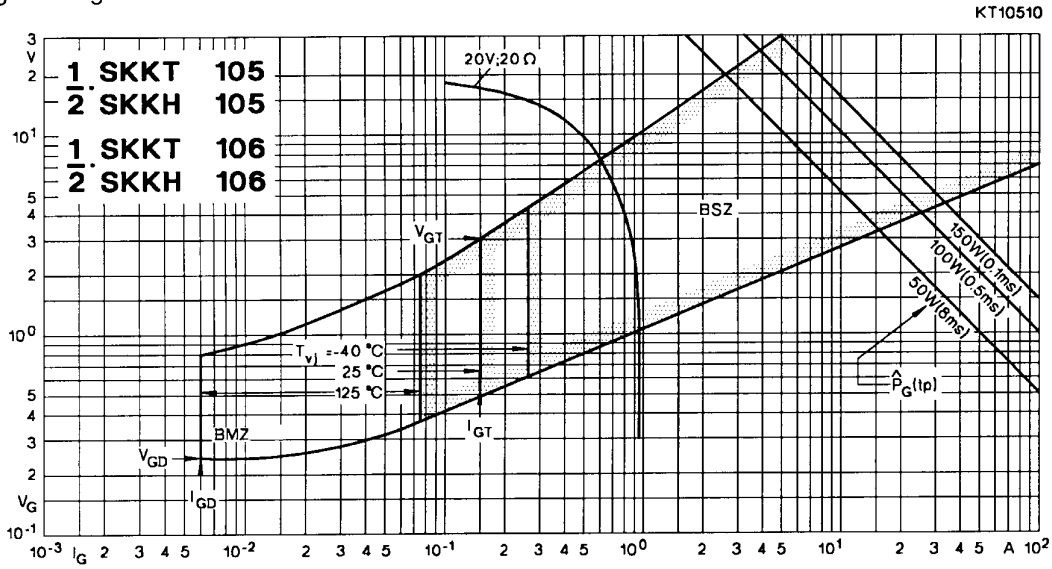

Fig. 10 Gate trigger characteristics

SKKT 19 ... 105

Case A 5

IEC 192-2: A 77 A

JEDEC: TO-240 AA

SEMIPACK® 1

UL recognized, file no. E 63 532



Dimensions in mm

SKKT 20/ ... 106/

Case A 46

IEC 192-2: A 77 A

JEDEC: TO-240 AA

SEMIPACK® 1

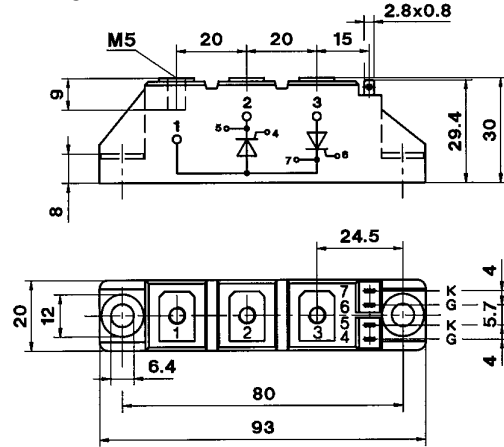

Dimensions in mm

SKKH 26 ... 105

Case A 6



SKKD 26 ... 100

Case A 10

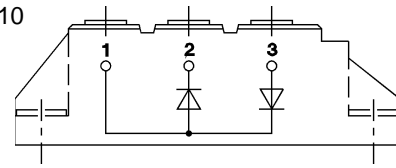

SKNH 56 ... 91

Case A 7



SKKE 81

Case A 12

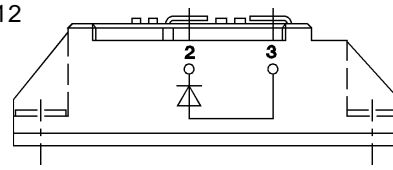

SKKL 56 ... 105

Case A 9

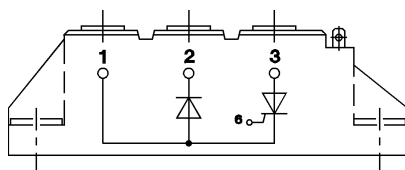

SKKH 27 ... 106

Case A 47

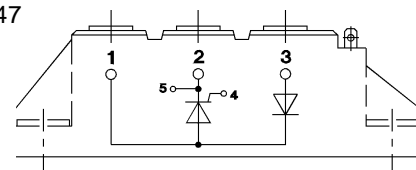

SKND 46 ... 81

Case A 19



SKKT 20 B ... 106 B

Case A 48

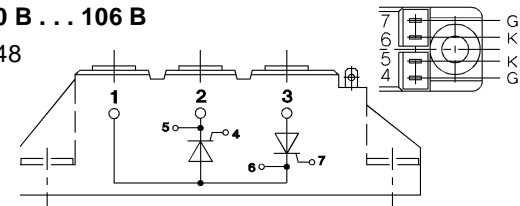

SKMT 92

Case A 72

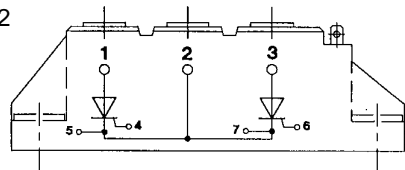

SKKL 42 ... 106

Case A 59

