

V_{RSM}	V_{RRM}	$(dv/dt)_{cr}$	I_{TRMS} (maximum value for continuous operation)		
	V_{DRM}		40 A		
V	V	V/ μ s	I_{TAV} (sin. 180; $T_{case} = 60\text{ }^\circ\text{C}$)		
			25 A		
700	600	500	SKKT 19/06 D	SKKT 20/06 D	–
900	800	500	SKKT 19/08 D	SKKT 20/08 D	SKKT 20B08 D
1300	1200	1000	SKKT 19/12 E	SKKT 20/12 E	SKKT 20B12 E
1500	1400	1000	SKKT 19/14 E	SKKT 20/14 E	SKKT 20B14 E
1700	1600	1000	SKKT 19/16 E	SKKT 20/16 E	SKKT 20B16 E

SEMIPACK® 1 Thyristor Modules

SKKT 19
SKKT 20
SKKT 20B

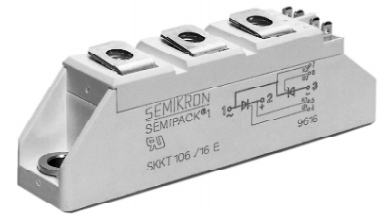

Symbol	Conditions	SKKT 19	SKKT 20 SKKT 20B	Units
I_{TAV}	sin. 180; $T_{case} = 60\text{ }^\circ\text{C}$ $T_{case} = 85\text{ }^\circ\text{C}$	25	18	A
I_D	B2/B6 $T_{amb} = 45\text{ }^\circ\text{C}$; P 3/180 $T_{amb} = 35\text{ }^\circ\text{C}$; P 3/180 F	31 / 38	46 / 60	A
I_{RMS}	W1/W3 $T_{amb} = 45\text{ }^\circ\text{C}$; P 3/180	42 / 3 x 30		A
I_{TSM}	$T_{vj} = 25\text{ }^\circ\text{C}$; 10 ms $T_{vj} = 125\text{ }^\circ\text{C}$; 10 ms	320	280	A
i^2t	$T_{vj} = 25\text{ }^\circ\text{C}$; 8,3 ... 10 ms $T_{vj} = 125\text{ }^\circ\text{C}$; 8,3 ... 10 ms	510	390	A ² s
t_{gd}	$T_{vj} = 25\text{ }^\circ\text{C}$; $I_G = 1\text{ A}$ $di_G/dt = 1\text{ A}/\mu\text{s}$	1		μs
t_{gr}	$V_D = 0,67 \cdot V_{DRM}$	1		μs
$(di/dt)_{cr}$	$T_{vj} = 125\text{ }^\circ\text{C}$	150		A/ μs
t_q	$T_{vj} = 125\text{ }^\circ\text{C}$	typ. 80		μs
I_H	$T_{vj} = 25\text{ }^\circ\text{C}$; typ./max.	100 / 200		mA
I_L	$T_{vj} = 25\text{ }^\circ\text{C}$; $R_G = 33\ \Omega$; typ./max.	250 / 400		mA
V_T	$T_{vj} = 25\text{ }^\circ\text{C}$; $I_T = 75\text{ A}$	max. 2,3		V
$V_{T(TO)}$	$T_{vj} = 125\text{ }^\circ\text{C}$	1,0		V
r_T	$T_{vj} = 125\text{ }^\circ\text{C}$	16		m Ω
I_{DD} ; I_{RD}	$T_{vj} = 125\text{ }^\circ\text{C}$; $V_{RD} = V_{RRM}$ $V_{DD} = V_{DRM}$	max. 10		mA
V_{GT}	$T_{vj} = 25\text{ }^\circ\text{C}$; d.c.	3		V
I_{GT}	$T_{vj} = 25\text{ }^\circ\text{C}$; d.c.	150		mA
V_{GD}	$T_{vj} = 125\text{ }^\circ\text{C}$; d.c.	0,25		V
I_{GD}	$T_{vj} = 125\text{ }^\circ\text{C}$; d.c.	5		mA
R_{thjc}	cont. } per thyristor / sin. 180 } per module rec. 120 }	1,2 / 0,6 1,3 / 0,65 1,35 / 0,68		$^\circ\text{C}/\text{W}$
R_{thch}		0,2 / 0,1		$^\circ\text{C}/\text{W}$
T_{vj}		- 40 ... + 125		$^\circ\text{C}$
T_{stg}		- 40 ... + 125		$^\circ\text{C}$
V_{isol}	a. c. 50 Hz; r.m.s.; 1 s/1 min	3600 / 3000		V~
M_1	to heatsink } SI (US) units to terminals }	5 (44 lb. in.) $\pm 15\%$ ¹⁾		Nm
M_2		3 (26 lb. in.) $\pm 15\%$		Nm
a		5 · 9,81		m/s ²
w	approx.	95		g
Case	→ page B 1 – 95	SKKT 19: A 5 SKKT 20: A 46 SKKT 20B: A 48		

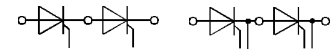

SKKT 19

SKKT 20
SKKT 20B

Features

- Heat transfer through aluminium oxide ceramic isolated metal baseplate
- Hard soldered joints for high reliability
- UL recognized, file no. E 63 532

Typical Applications

- DC motor control (e.g. for machine tools)
- AC motor soft starters
- Temperature control (e.g. for ovens, chemical processes)
- Professional light dimming (studios, theaters)

¹⁾ See the assembly instructions

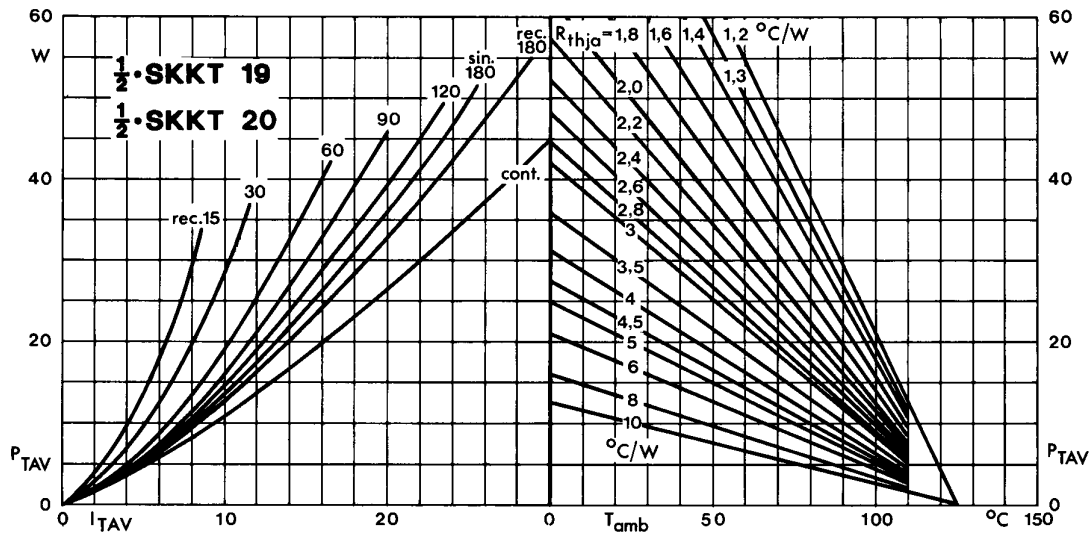

Fig. 1 Power dissipation per thyristor vs. on-state current and ambient temperature

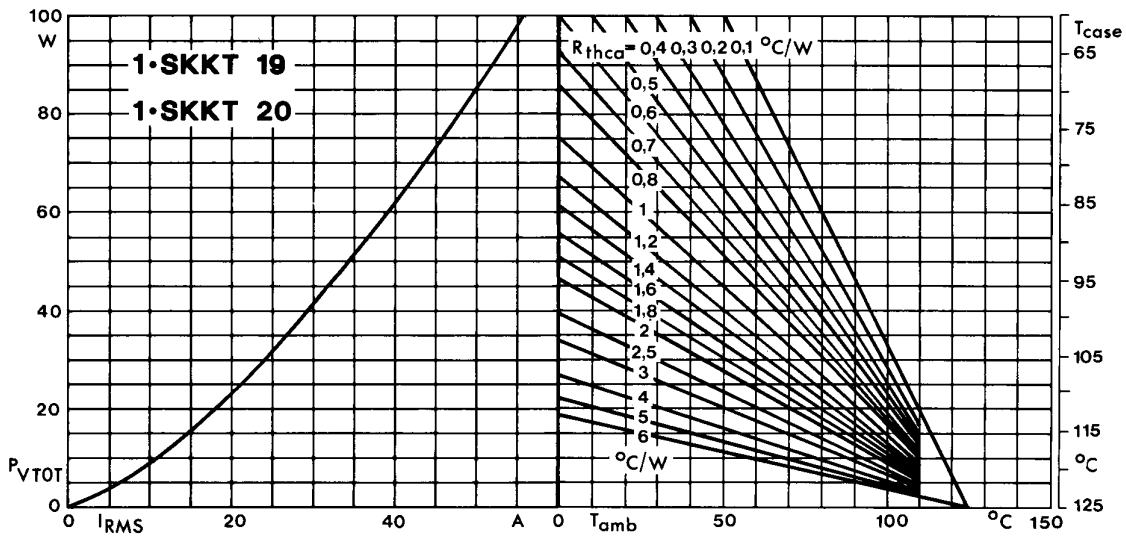

Fig. 2 Power dissipation per module vs. rms current and case temperature

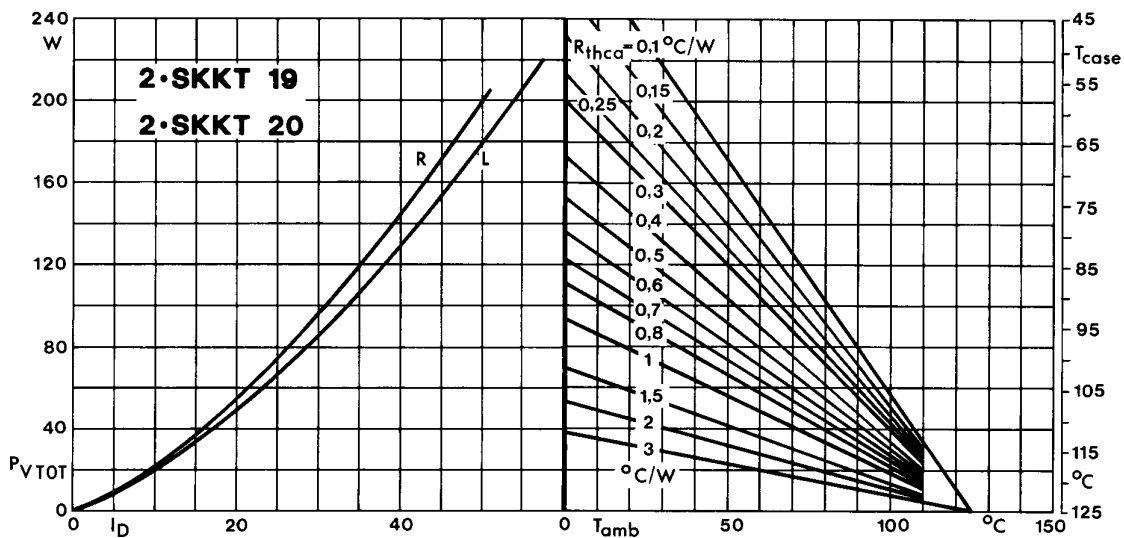

Fig. 3 Power dissipation of two modules vs. direct current and case temperature

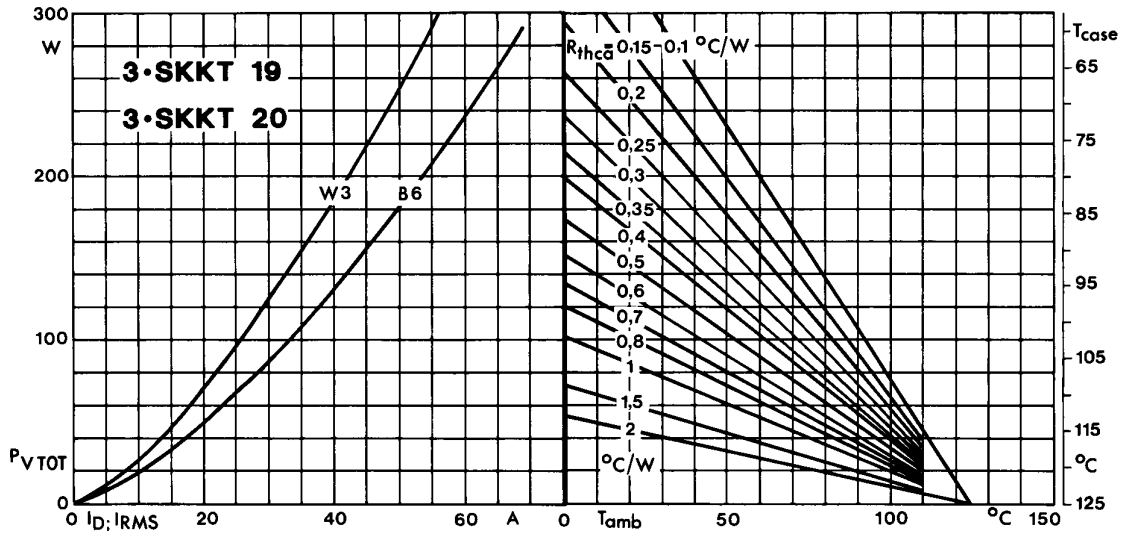

Fig. 4 Power dissipation of three modules vs. direct and rms current and case temperature

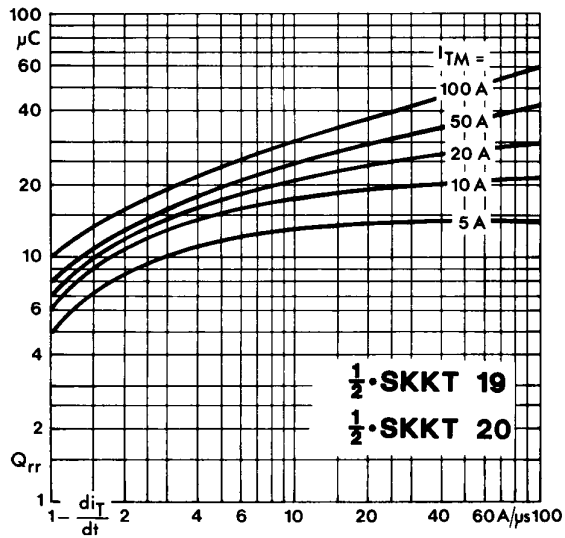

Fig. 5 Recovered charge vs. current decrease

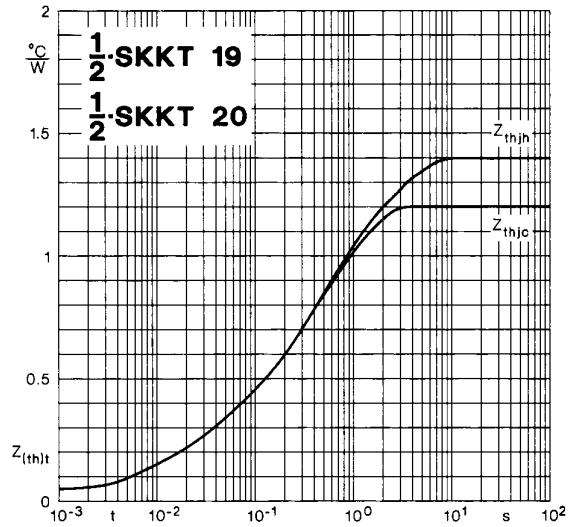

Fig. 6 Transient thermal impedance vs. time

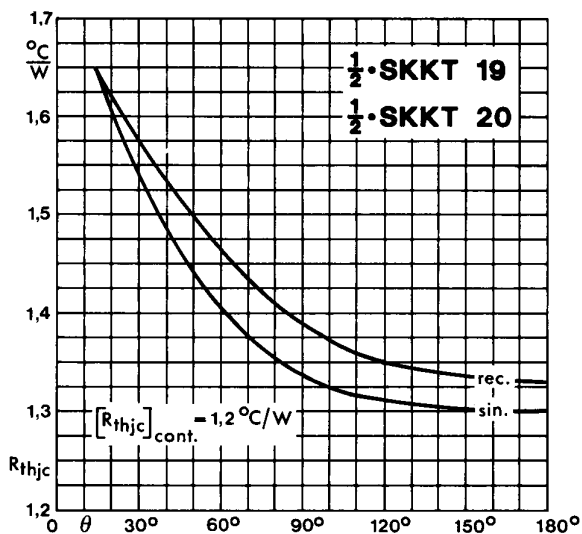

Fig. 7 Thermal resistance vs. conduction angle

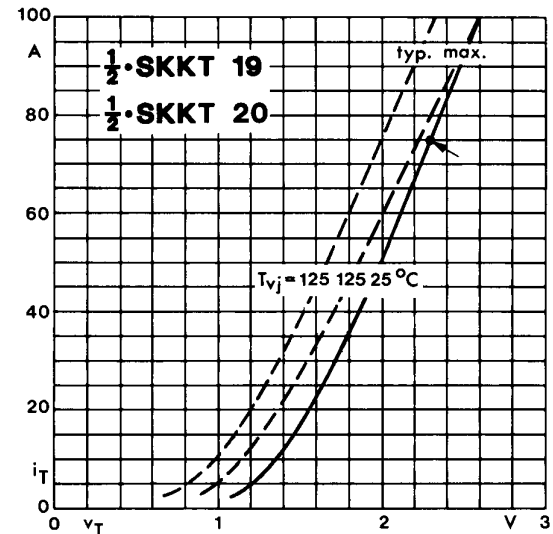

Fig. 8 On-state characteristics

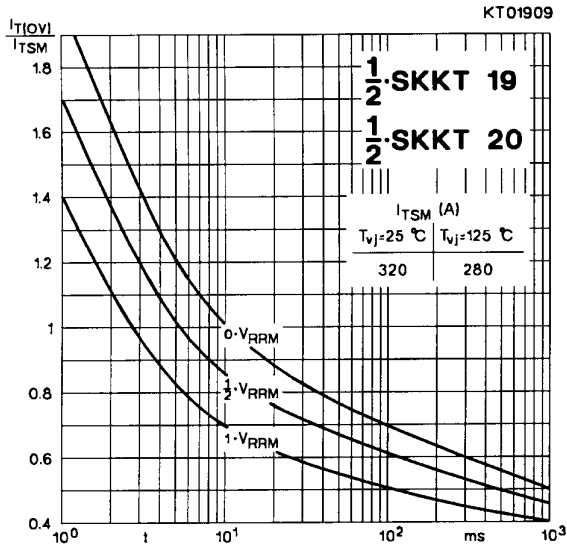

Fig. 9 Surge overload current vs. time

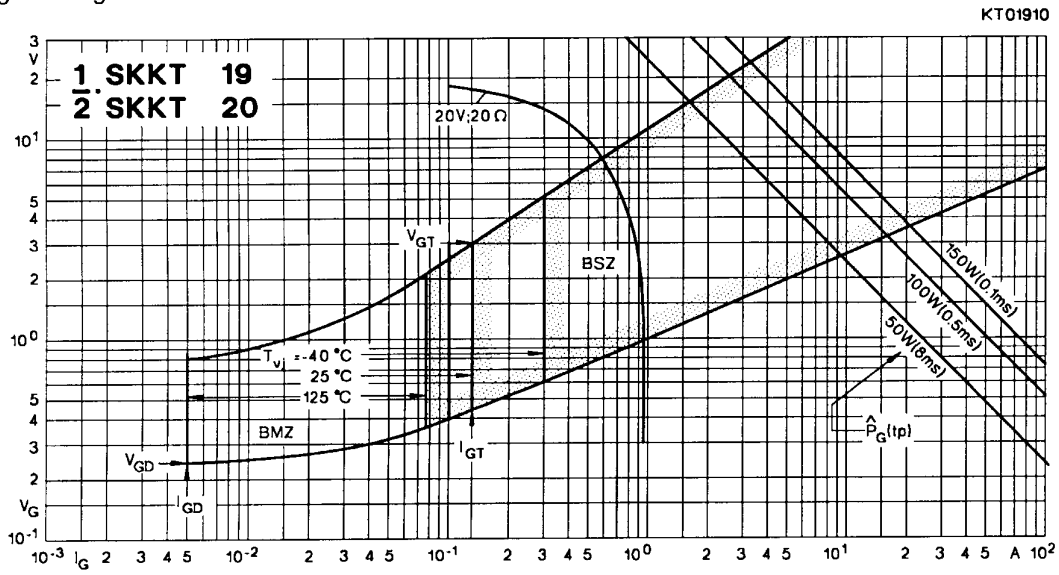

Fig. 10 Gate trigger characteristics

SKKT 19 ... 105

Case A 5

IEC 192-2: A 77 A

JEDEC: TO-240 AA

SEMIPACK® 1

UL recognized, file no. E 63 532



Dimensions in mm

SKKT 20/ ... 106/

Case A 46

IEC 192-2: A 77 A

JEDEC: TO-240 AA

SEMIPACK® 1

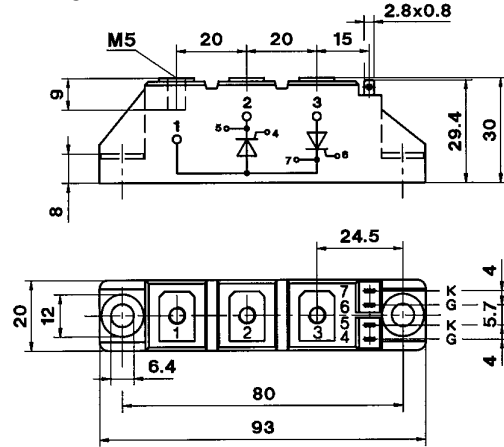

Dimensions in mm

SKKH 26 ... 105

Case A 6



SKKD 26 ... 100

Case A 10

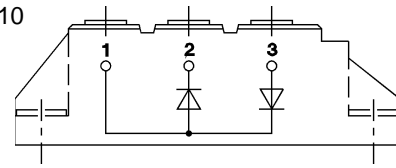

SKNH 56 ... 91

Case A 7



SKKE 81

Case A 12

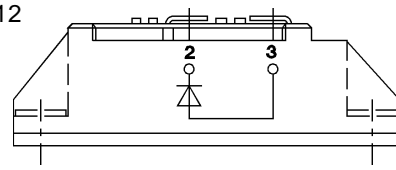

SKKL 56 ... 105

Case A 9

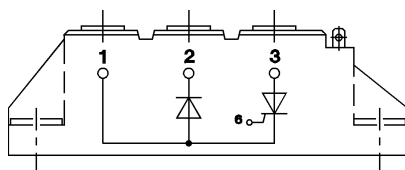

SKKH 27 ... 106

Case A 47

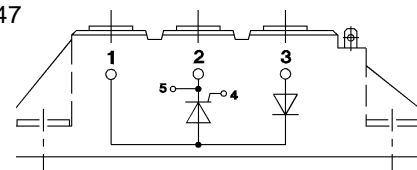

SKND 46 ... 81

Case A 19



SKKT 20 B ... 106 B

Case A 48

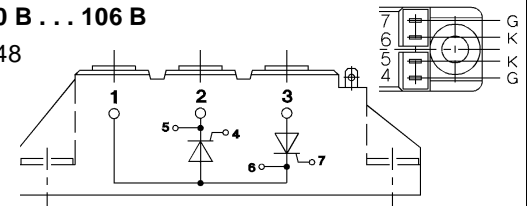

SKMT 92

Case A 72

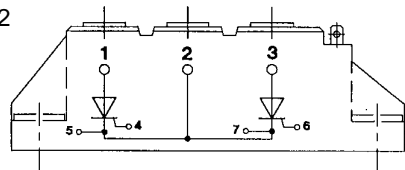

SKKL 42 ... 106

Case A 59

