

# SKCH 28

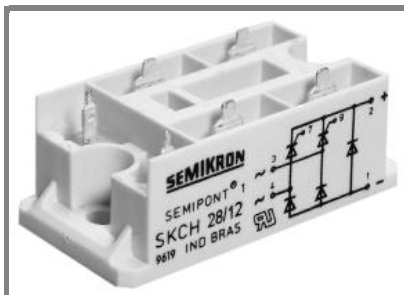

SEMIPONT® 1

## Controllable Bridge Rectifiers

### SKCH 28

#### Features

- Sturdy isolated metal baseplate
- Fast-on terminals with solder tips
- Suitable for wave soldering
- High surge current rating
- UL recognized, file no. E 63 532

#### Typical Applications

- Controllable single phase rectifier
- DC power supplies
- DC motor controllers
- DC motor field controllers

1) Painted metal shield of minimum 250 x 250 x 1 mm:  $R_{th(c-a)} = 1,85 \text{ K/W}$

2) Freely suspended or mounted on insulator

$V_{RSM}$ V	$V_{RRM}, V_{DRM}$ V	$I_D = 28 \text{ A}$ (full conduction) ( $T_c = 89 \text{ }^\circ\text{C}$ )
400	400	SKCH 28/04
600	600	SKCH 28/06
800	800	SKCH 28/08
1200	1200	SKCH 28/12
1400	1400	SKCH 28/14

Symbol	Conditions	Values	Units
$I_D$	$T_c = 85 \text{ }^\circ\text{C}$	30	A
	$T_a = 45 \text{ }^\circ\text{C}$ ; chassis 1)	13	A
	$T_a = 45 \text{ }^\circ\text{C}$ ; P5A/100	15	A
	$T_a = 45 \text{ }^\circ\text{C}$ ; P13A/125	16	A
	$T_a = 45 \text{ }^\circ\text{C}$ ; P1A/120	23	A
$I_{TSM}, I_{FSM}$	$T_{vj} = 25 \text{ }^\circ\text{C}$ ; 10 ms	320	A
	$T_{vj} = 125 \text{ }^\circ\text{C}$ ; 10 ms	280	A
$i^2t$	$T_{vj} = 25 \text{ }^\circ\text{C}$ ; 8,3 ... 10 ms	510	A <sup>2</sup> s
	$T_{vj} = 125 \text{ }^\circ\text{C}$ ; 8,3 ... 10 ms	390	A <sup>2</sup> s
$V_T$	$T_{vj} = 25 \text{ }^\circ\text{C}$ ; $I_T = 75 \text{ A}$	max. 2,25	V
$V_{T(TO)}$	$T_{vj} = 125 \text{ }^\circ\text{C}$ ;	max. 1	V
$r_T$	$T_{vj} = 125 \text{ }^\circ\text{C}$	max. 16	m $\Omega$
$I_{DD}, I_{RD}$	$T_{vj} = 125 \text{ }^\circ\text{C}$ ; $V_{DD} = V_{DRM}$ ; $V_{RD} = V_{RRM}$	max. 8	mA
$t_{gd}$	$T_{vj} = 25 \text{ }^\circ\text{C}$ ; $I_G = 1 \text{ A}$ ; $di_G/dt = 1 \text{ A}/\mu\text{s}$	1	$\mu\text{s}$
$t_{gr}$	$V_D = 0,67 \cdot V_{DRM}$	1	$\mu\text{s}$
$(dv/dt)_{cr}$	$T_{vj} = 125 \text{ }^\circ\text{C}$	max. 500	V/ $\mu\text{s}$
$(di/dt)_{cr}$	$T_{vj} = 125 \text{ }^\circ\text{C}$ ; $f = 50 \text{ Hz}$	max. 50	A/ $\mu\text{s}$
$t_q$	$T_{vj} = 125 \text{ }^\circ\text{C}$ ; typ.	80	$\mu\text{s}$
$I_H$	$T_{vj} = 25 \text{ }^\circ\text{C}$ ; typ. / max.	50 / 150	mA
$I_L$	$T_{vj} = 25 \text{ }^\circ\text{C}$ ; $R_G = 33 \text{ } \Omega$	100 / 300	mA
$V_{GT}$	$T_{vj} = 25 \text{ }^\circ\text{C}$ ; d.c.	min. 2	V
$I_{GT}$	$T_{vj} = 25 \text{ }^\circ\text{C}$ ; d.c.	min. 100	mA
$V_{GD}$	$T_{vj} = 125 \text{ }^\circ\text{C}$ ; d.c.	max. 0,25	V
$I_{GD}$	$T_{vj} = 125 \text{ }^\circ\text{C}$ ; d.c.	max. 3	mA
$R_{th(j-c)}$	per thyristor / diode	1,8	K/W
	total	0,45	K/W
$R_{th(c-s)}$	total	0,1	K/W
$R_{th(j-a)}$	total 2)	15	K/W
$T_{vj}$		- 40 ... + 125	$^\circ\text{C}$
$T_{stg}$		- 40 ... + 125	$^\circ\text{C}$
$V_{isol}$	a. c. 50 Hz; r.m.s.; 1 s / 1 min.	3600 ( 3000 )	V
$M_s$	case to heatsink	2	Nm
$M_t$		n.a.	Nm
$m$		66	g
Case	SKCH	G 25	

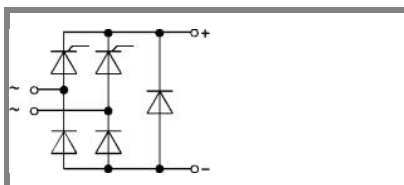

SKCH

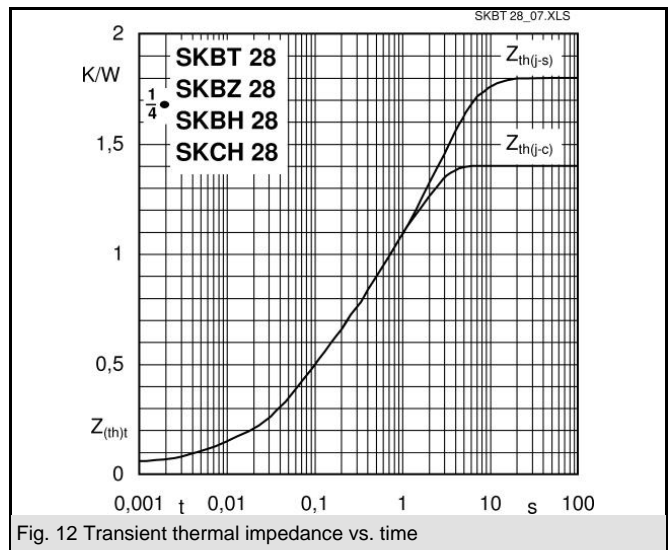
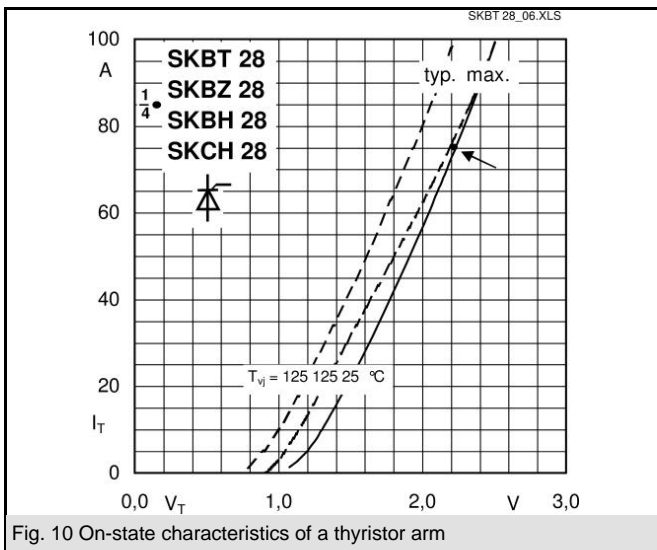
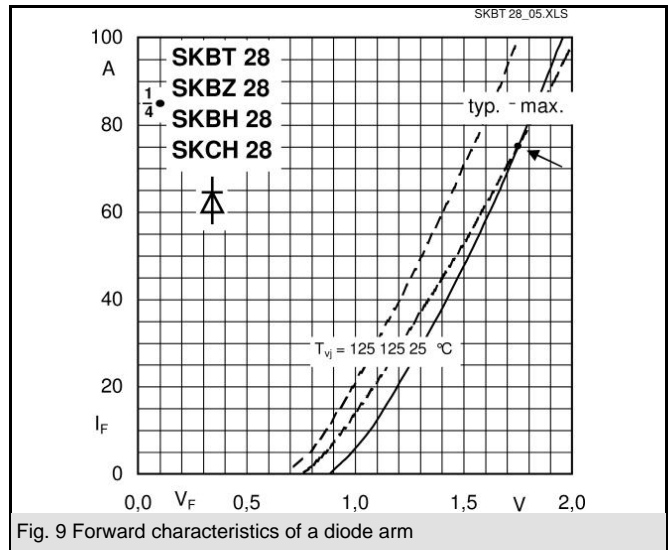
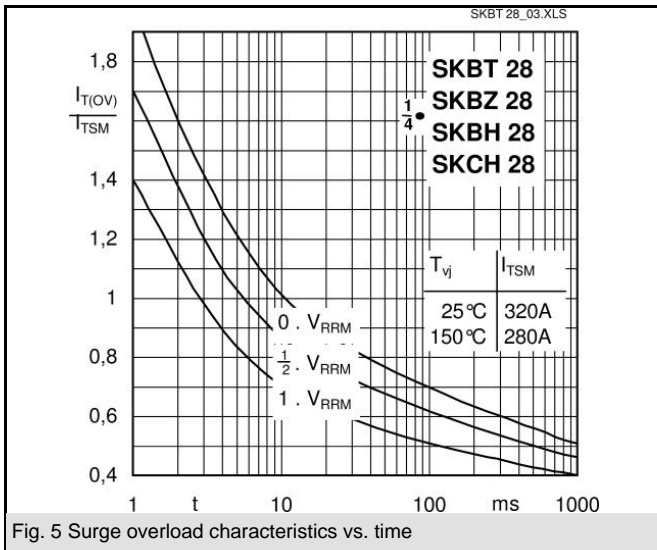
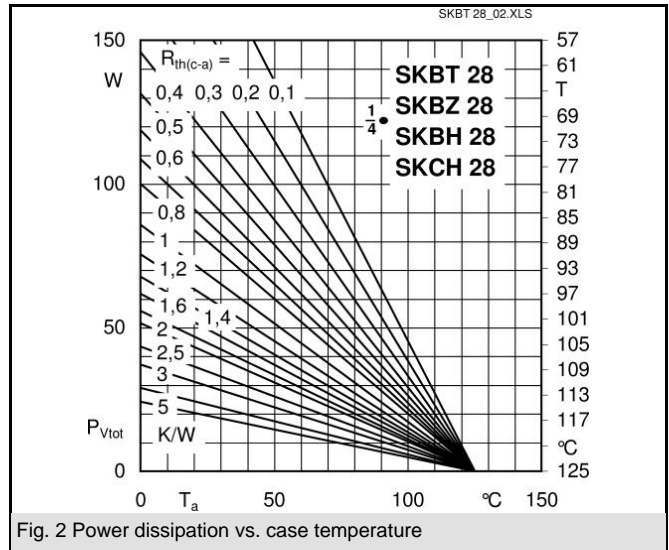
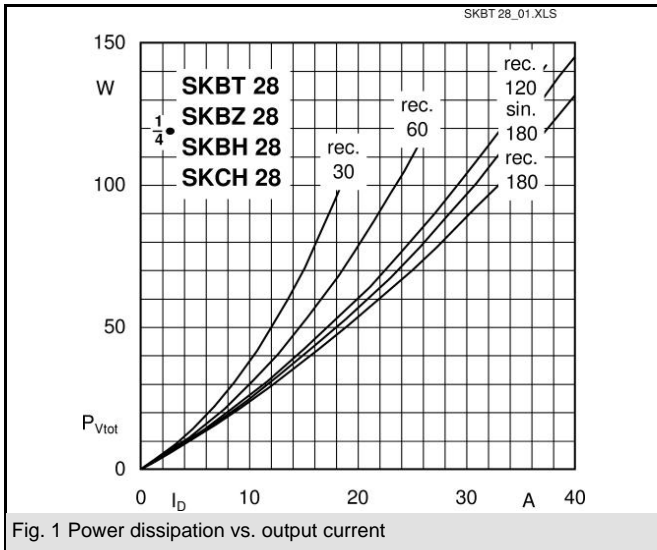

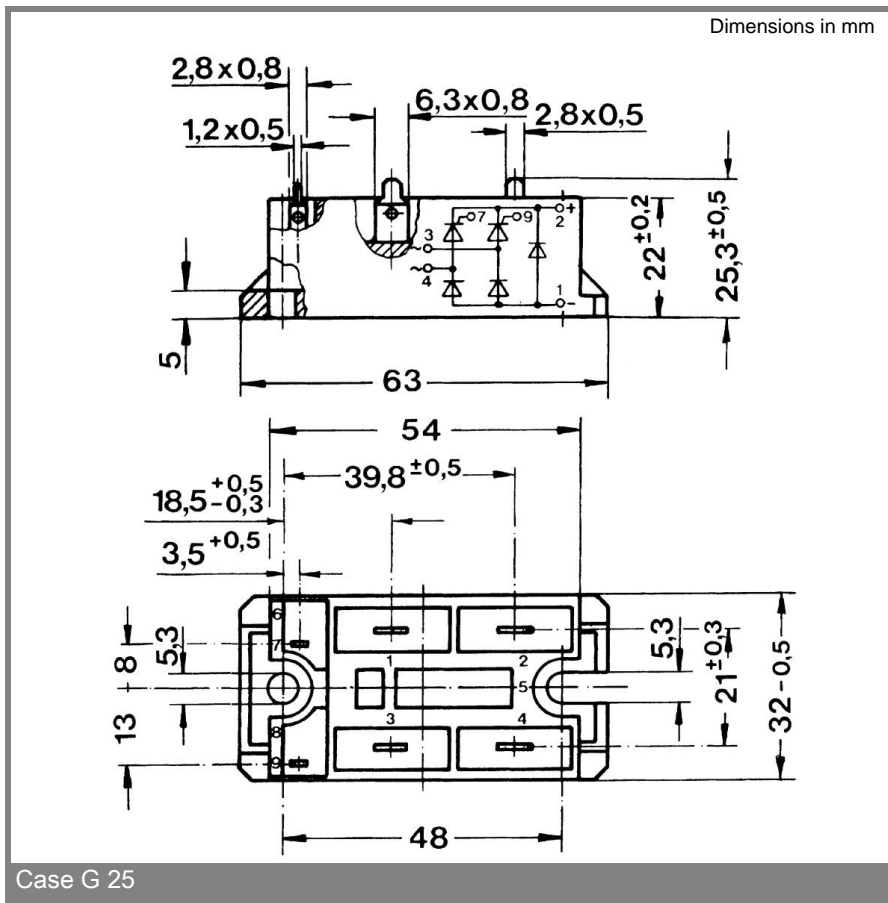
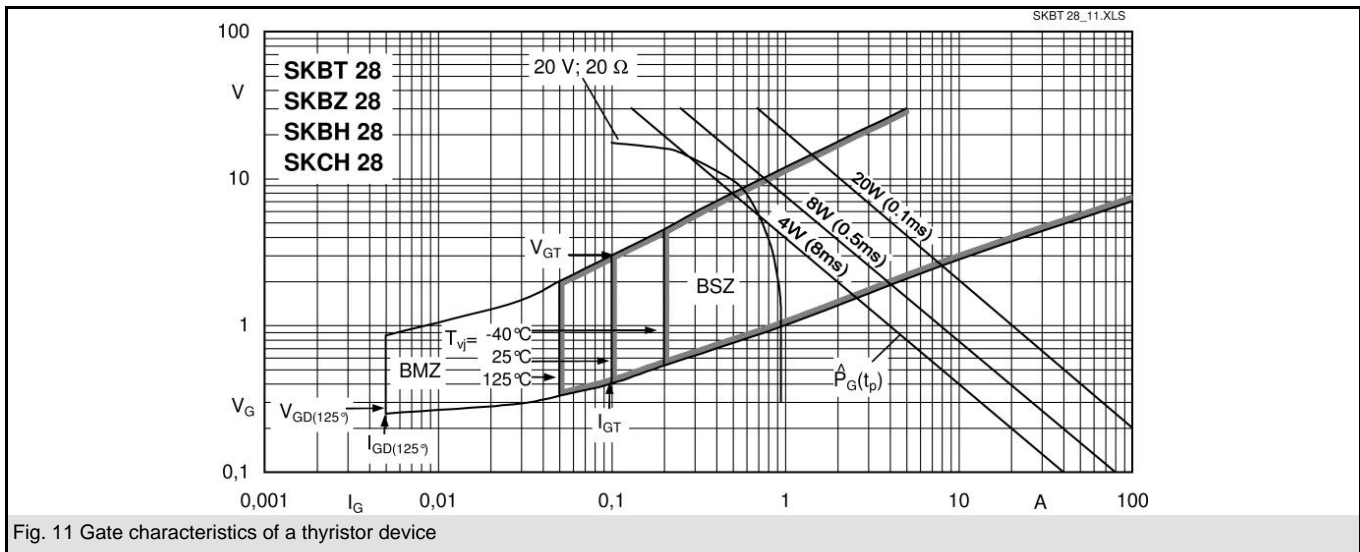

This technical information specifies semiconductor devices but promises no characteristics. No warranty or guarantee expressed or implied is made regarding delivery, performance or suitability.