

## NFC40 SERIES

Single and triple output



US Patent No. 4621311

[ 2 YEAR WARRANTY ]



- 40 Watts in a 2.2 x 2.2 x 0.5 inch case
- Base plate cooled patented topology
- Remote ON/OFF control
- Short circuit protection
- Industry standard pin-out
- UL, CSA and VDE safety approvals
- Extended operating temperature range option
- Fixed frequency operation

Providing 40W of power in a 2.2 x 2.2 x 0.5 inch package, the highly specified NFC40 Series of DC/DC converters were designed with today's demanding applications in mind. Inherent design specifications of the NFC40 include tight line and load regulation and high power density. Standard features provided by all members of the NFC40 Series are remote on/off, synchronization function, short circuit protection, overvoltage protection and an output voltage trim function. To maximize the board area available to system designers, the NFC40 footprint has been minimised without compromising on features or profile. A comprehensive package of heatsink and operating temperature options are included to further increase the flexibility offered. Artesyn Technologies has utilised its latest patented topology implemented in SMT and hybrid technologies to achieve this performance level. Typical applications for the NFC40 Series include telecommunications, remote exchanges, automation equipment, back plane power architectures and distributed power.

## SPECIFICATION All specifications are typical at nominal input, full load at 25°C unless otherwise stated

OUTPUT SPECIFICATIONS		
Voltage adjustability	All outputs (See Note 8)	±10%
Total error band (See Note 1)	Single outputs Auxiliary outputs	±2% typ., ±3% max. ±3% typ., ±5% max.
Ripple and noise	5Hz to 20MHz All outputs	100mV pk-pk, max. 20mV rms
Transient response	0.25% FL to 0.5% FL	±2% max. dev., 100µs recovery
Temperature coefficient	Single outputs Auxiliary outputs	±0.02%/°C max. ±0.03%/°C max.
Overvoltage protection	Single output Triple output	Clamp type See table
Short circuit protection		Continuous automatic recovery
Minimum main output current	Singles Triples, to maintain auxiliary output regulation	0A 0.5A
INPUT SPECIFICATIONS		
Input voltage range	24V 48V	18 to 36VDC 36 to 72VDC
Input filter	(See Note 9)	External capacitor
Remote ON/OFF Logic compatibility	ON OFF	CMOS and TTL >1.5V or open collector <0.4V
Synchronization function	Frequency control range Sync signal	Operating frequency control ±10% Negative-going pulse, maximum 25% of duty cycle
Logic compatibility		CMOS/TTL

GENERAL SPECIFICATIONS		
Efficiency	See table	80%, min.
Isolation voltage	Input/output	500VAC, 710VDC, min.
Switching frequency	Fixed	300kHz ±5.0%
Approvals and standards		VDE0805, EN60950 IEC950, UL1950 CSA C22.2 No. 950
Case material		Black coated metal with Non-conductive base
Material flammability		UL94V-0
Weight		80g (2.8oz)
ENVIRONMENTAL SPECIFICATIONS		
Thermal performance (See Note 11)	Operating ambient Operating Case Non-operating Extended temp., option, case (Note 10) Heatsink option (Note 5) Derating	See curves -25°C to +105°C -55°C to +125°C -40°C to +105°C See curves See curves for baseplate cooling details
Relative humidity	Non-condensing	5% to 95% RH
Altitude	Operating Non operating	10,000 feet max. 40,000 feet max.

### International Safety Standard Approvals

VDE0805/EN60950/IEC950 File No. 10401-3336-1082

UL1950 File No. E136005

CSA C22.2 No. 950 File No. LR41062C

Data Sheet © Artesyn Technologies® 2000

The information and specifications contained in this data sheet are believed to be correct at time of publication. However, Artesyn Technologies accepts no responsibility for consequences arising from printing errors or inaccuracies. Specifications are subject to change without notice. No rights under any patent accompany the sale of any such product(s) or information contained herein.

# 40 Watt Wide input DC/DC converters

INPUT VOLTAGE (2)	OUTPUT VOLTAGE	OVP (3)	MAX. OUTPUT CURRENT	INPUT CURRENT (4)	TYPICAL EFFICIENCY	MODEL NUMBER (5, 10)	
						METRIC INSERTS	IMPERIAL INSERTS
18-36VDC	5VDC	6.2VDC	8A	2.15A	80%	NFC40-24S05-M	NFC40-24S05
18-36VDC	12VDC	15VDC	3.5A	2.1A	82%	NFC40-24S12-M	NFC40-24S12
18-36VDC	15VDC	18VDC	2.8A	2.1A	82%	NFC40-24S15-M	NFC40-24S15
18-36VDC	5/±12VDC	6.2VDC/None	7.5/±0.75A	2.15A	80%	NFC40-24T05-12-M	NFC40-24T05-12 (6)
18-36VDC	5/±15VDC	6.2VDC/None	7.5/±0.75A	2.15A	80%	NFC40-24T05-15-M	NFC40-24T05-15 (6)
36-72VDC	5VDC	6.2VDC	8A	1.1A	81%	NFC40-48S05-M	NFC40-48S05
36-72VDC	12VDC	15VDC	3.5A	1.05A	83%	NFC40-48S12-M	NFC40-48S12
36-72VDC	15VDC	18VDC	2.8A	1.05A	83%	NFC40-48S15-M	NFC40-48S15
36-72VDC	5/±12VDC	6.2VDC/None	7.5/±0.75A	1.1A	81%	NFC40-48T05-12-M	NFC40-48T05-12 (6)
36-72VDC	5/±15VDC	6.2VDC/None	7.5/±0.75A	1.1A	81%	NFC40-48T05-15-M	NFC40-48T05-15 (6)

## Notes

- Total error band is defined at the static output regulation at 25°C, including initial setting accuracy, line voltage within stated limits and load current within stated limits.
- Nominal input voltages are 24VDC and 48VDC.
- Overvoltage protection threshold. Any main output overvoltage clamps the output to a very low output voltage. A prolonged overvoltage condition will cause the converter to fail.
- Maximum value at full load, nominal input voltage.
- For top-mounted heatsink option with Metric screws, add '-MX' or '-MY' to these model numbers. For side-mounted heatsink option, add '-ME' or '-MS' to the model number e.g. **NFC40-48S05-MX**. For top-mounted heatsink option with Imperial screws, add '-1X' or '-1Y' to these model numbers. For side-mounted heatsink option, add '-1E' or '-1S' to the model number e.g. **NFC40-48S05-1X**.
- For triple output units, common pins (5 and 8) should be connected externally.
- Output V1 must return to common 1 and outputs V2 and V3 to common 2 and 3 respectively in order to meet noise and regulation specifications.
- The external trim function enables the tailoring of the output voltage to the applications exact requirements. Adjustments within ±10% are possible. On the triple output models the auxiliary output voltages (output 2 and 3) will vary proportionally to the main output.
- An external filter capacitor is required for normal operation. The capacitor should be capable of handling 1A/2A ripple current for 48V/24V models. Artesyn suggests: Nippon Chemi-Con SXE series, 220µF/100V for the NFC40-48xxx-M and the Nippon Chemi-Con LXF Series, 1500µF/50V for the NFC40-24xxx-M.
- Extended operating temperature range. To specify an NFC40 that operates down to -40°C, add the suffix '4' or '-4' to the model number e.g. **NFC40-48S05-M4** or **NFC40-48S05-4** for Metric and Imperial screw measurements respectively.
- Case temperature must not exceed +105°C. Curve may be extended or restricted depending on available cooling.

PIN CONNECTIONS (6,7)		
PIN NUMBER	SINGLE OUTPUT	TRIPLE OUTPUT
1	+ Input	+ Input
2	- Input	- Input
3	Control	Control
4	No Connection	+ Vout 2
5	No Connection	Common 2, 3
6	No Connection	- Vout 3
7	+ Output	+ Vout 1
8	Common	Common 1
9	Trim	Trim

## Mechanical notes

- A All pins are actual to within 0.010 inch (0.25mm) diameter.  
 B Tolerances:  
 Imperial 0.XX ± 0.02 inch  
 0.XXX ± 0.005 inch  
 Metric 0.X ± 0.5mm  
 0.XX ± 0.13mm  
 Unless otherwise specified.  
 C Metric dimensions in brackets, e.g. 1.250" (31.75mm).  
 D Copper tracks must not be routed under the four converter stand-offs.

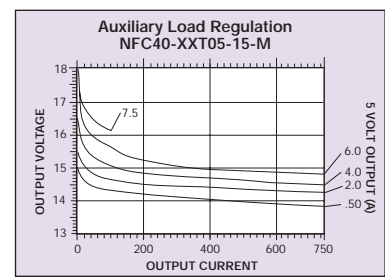
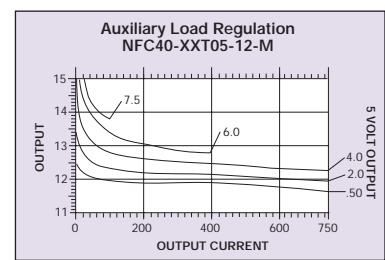
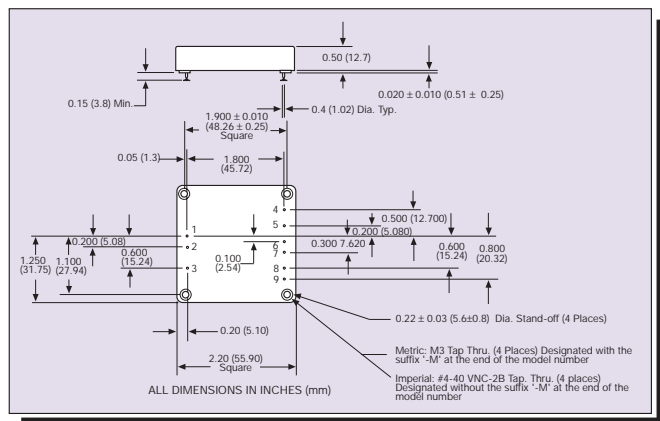

# 40 Watt Wide input DC/DC converters

## Derating Curves

The derating curves shown are based on measurements of actual power supplies and reflect Artesyn Technologies conservative design guidelines. Adherence to these guidelines contributes to the high reliability of our products by restricting the maximum operating semiconductor junction temperatures to 125°C which is well below the component manufacturers' maximum limits.

### Key to power derating curves:

- A Natural convection.
- B 150 linear feet per minute forced air flow.
- C 300 linear feet per minute forced air flow.
- D Maximum case temperature

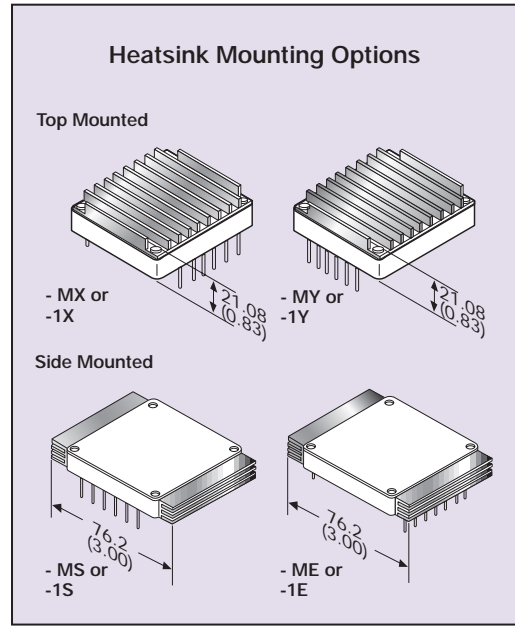
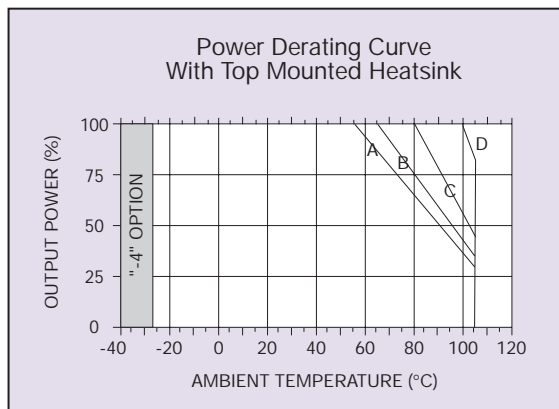
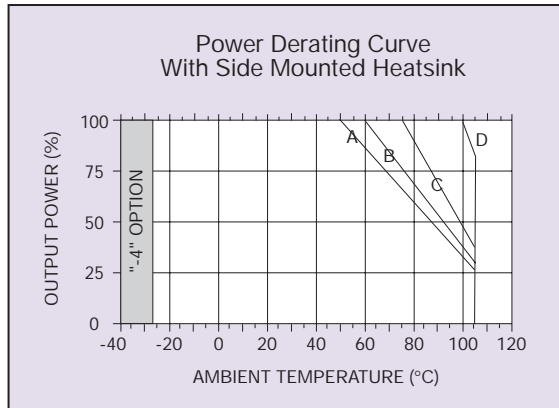
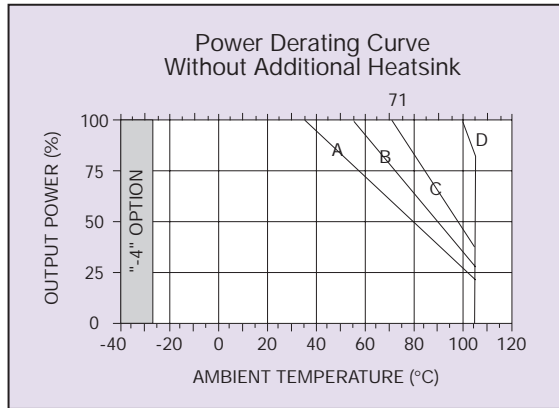

### Heatsink options:

Two heatsink kits are available for the NFC40: top mounted and side mounted. Each heatsink may be oriented parallel to or perpendicular to the direction of the pins, thus providing optimum flexibility for cooling requirements.

#### Top mounted heatsink

If board area is at a premium in your application then the top mounted heatsink should be used. This heatsink kit comes complete with screws and is mounted as shown in the diagram over. To fit the heatsink, place it in the required orientation, and tighten the four screws. The order number for the top mounted heatsink kit with Metric screws is: **NFC40-HTSK-T**. The order number for the top mounted heatsink kit with Imperial screws is: **NFC40-HTSK-T-I**.

#### Side mounted heatsink

With many applications, e.g. rack systems, the profile must be kept to a minimum. The side mounted heatsink is intended to meet the requirements of low profile applications. The NFC40 with this heatsink option is 12.7mm (0.5 inch) high. The kit contains two side mounted heatsinks, which must be fitted opposite to one another on the NFC40. The order number for the side mounted heatsink is: **NFC40-HTSK-S**

#### Factory fitted heatsinks

As a further option, Artesyn Technologies offers factory fitted heatsinks. Simply add the suffix as described by the diagrams above to the part number: e.g. **NFC40-48S12-MY** or **NFC40-48S12-1Y** for Metric and Imperial screws respectively.

