

25–40 W DC/DC Power Modules 24 V Input Series

- *Single, dual and triple output*
- *500 V dc isolation voltage*
- *MTBF >2 million hours @ 75 °C case temperature*
- *Complete, no extra filters or heatsinks required*



The 25-40 watts PKA 2000 series hybrid DC/DC power modules are especially designed for decentralized 24/28 Vdc system distributed onboard DC/DC converters. By using a thickfilm technology, which provides a high degree of integration as well as efficient thermal management, and by utilizing a 300 kHz switching frequency, these highly reliable products comply to demanding applications within e.g. cellular radio, medical, industrial and airborne industry. Input to output isolation is 500 Vdc. Mechanical ruggedness – in conformance with IEC 68-2 - is close to requirements for discrete

components. Extreme temperature conditions can be met since the converters can operate with full output power in ambient temperatures ranging from -45 to +85 °C or up to +115 °C case temperature, making the products ideal also for applications within various non-controlled environments.

The PKA series is manufactured using highly automated manufacturing lines with a world-class quality commitment and a five-year warranty. Ericsson Microelectronics AB has been an ISO 9001 certified supplier since 1991. *For a complete product program please reference the back cover.*

General

Absolute Maximum Ratings

Characteristics		min	max	Unit
T _C	Case temperature ¹⁾	-45	+115	°C
T _S	Storage temperature	-55	+125	°C
V _I	Input voltage	-0.5	36	V dc
V _{ISO}	Isolation voltage (input to output test voltage)	500		V dc
	Transient input energy @ T _A = +25 °C	1.3		Ws
V _{RC}	Remote control voltage (pin 9)	0	5	V
V _{adj}	Output adjust voltage (pin 10)	0	V _O	V

¹⁾ Corresponding ambient temp. range (T_A) at full output power is -45 to +85 °C.

Input T_C < T_C max

Characteristics		Conditions	min	typ	max	Unit
V _I	Input voltage range	T _C < T _C max	19		32	V
		T _C < + 95 °C	19		35	V
V _{off}	Turn-off input voltage	(See Operating Information)	13		18	V
I _{Irush}	Inrush current ²⁾	I _O = I _O nom		15		A
I _{I2t}				5×10 ⁻⁴		A ² s
P _{li}	Input idling power	I _O =0, T _C = 0...+95°C		0.8		W
	Input transient peak current (transient immunity)	P < 1 kW, V _C < 50 V, t _r /t _d = 10/1000 μs		20		A

²⁾ PKA 2411 PIL = 30 A, 2×10⁻³ A²s
 PKA 2432 PIL = 30 A, 5×10⁻³ A²s

Environmental Characteristics

Characteristics	Test procedure & conditions		
Vibration (Sinusoidal)	IEC 68-2-6 F _C	Frequency Amplitude Acceleration Number of cycles	10–500 Hz 0.75 mm 10 g 10 in each axis
Shock (Half sinus)	IEC 68-2-27 E _a	Peak acceleration Shock duration	200 g 3 ms
Bump (Half sinus)	IEC 68-2-29 E _b	Peak acceleration Bump duration Number of bumps	40 g 6 ms 1000 in 6 directions
Temperature change	IEC 68-2-14 N _a	Temperature Number of cycles	-40°C to +125°C 10
Damp heat	IEC 68-2-3 C _a	Temperature Duration	40°C 56 days
Accelerated damp heat	IEC 68-2-3 C _a with bias	Temperature Humidity Duration	85°C 85% RH 500 hours

Stress in excess of Absolute Maximum Ratings may cause permanent damage. Absolute Maximum Ratings, sometimes referred to as no destruction limits, are normally tested with one parameter at a time exceeding the limits of Output data or Electrical Characteristics. If exposed to stress above these limits, function and performance may degrade in an unspecified manner.

Safety

The PKA 2000 I Series DC/DC power modules are designed in accordance with EN 60 950, *Safety of information technology equipment including electrical business equipment* and certified by SEMKO.

The PKA power modules are recognized by UL and meet the applicable requirements in UL 1950 *Safety of information technology equipment*, the applicable Canadian safety requirements and UL 1012 *Standard for power supplies*.

The DC/DC power module shall be installed in an end-use equipment and considerations should be given to measuring the case temperature to comply with T_Cmax when in operation. They are intended to be supplied by isolated secondary circuitry and shall be installed in compliance with the requirements of the ultimate application. If connected to a 24 V DC power system reinforced insulation must be provided in the power supply that isolates the input from the ac mains. The isolation in the DC/DC power module is an operational insulation in accordance with EN 60 950. One pole of the input and one pole of the output is to be grounded or both are to be kept floating.

The terminal pins are only intended for connection to mating connectors of internal wiring inside the end-use equipment.

The isolation voltage is a galvanic isolation and is verified in an electric strength test. Test voltage (V_{ISO}) between input and output is 500 V dc.

The capacitor between input and output has a value of 10 nF and the leakage current is less than 1 μA @ 26 V dc.

Flammability ratings of the terminal support and internal plastic construction details meets UL 94V-0.

Mechanical Data

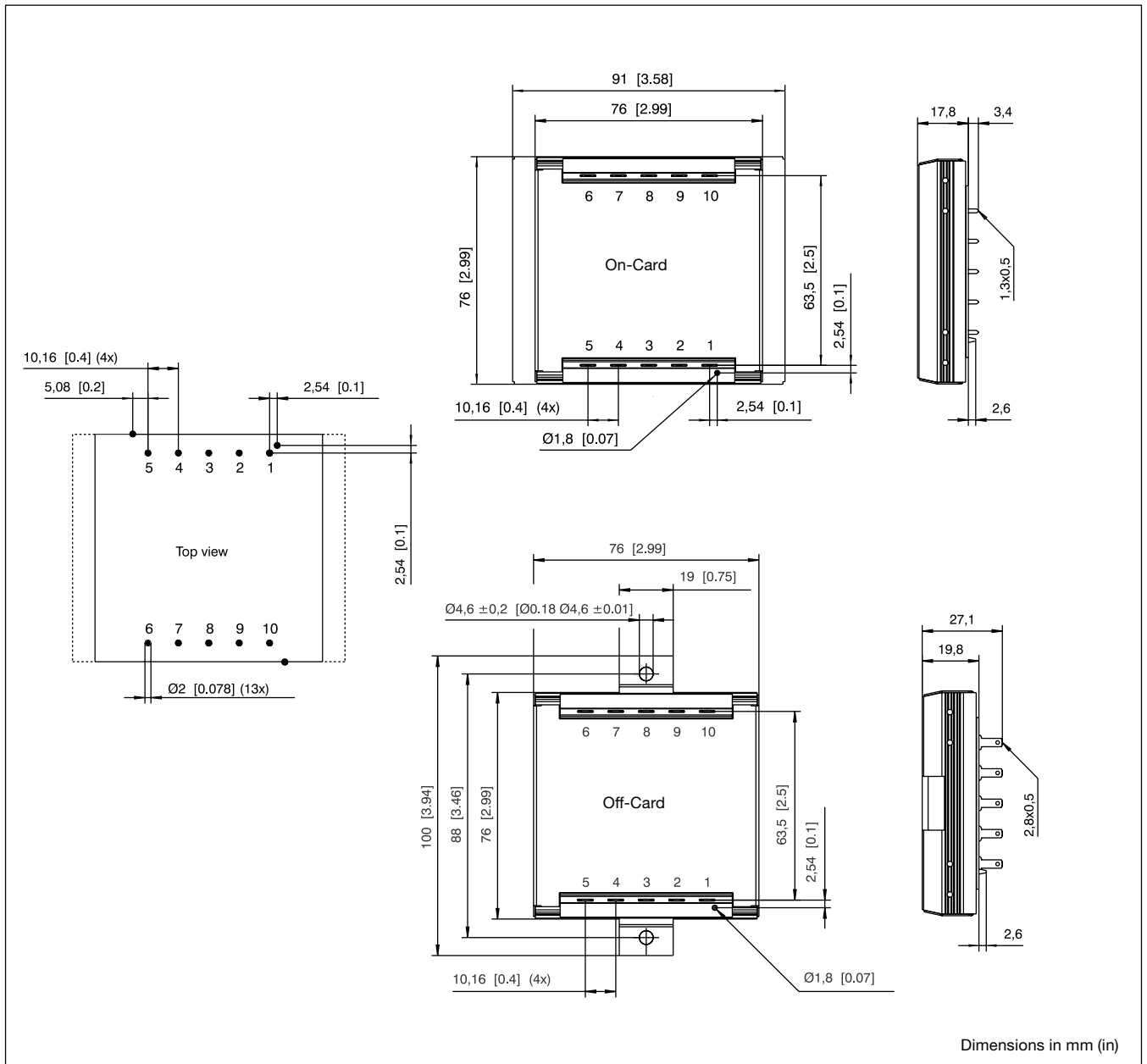

Connections

Pin	Designation	Function
1	RC	Remote control. To turn-on and turn-off the output. It is also used to adjust the turn-off input voltage threshold.
2	NC	Not connected.
3	-In	Negative input.
4	+In	Positive input.
5	Aux	Auxiliary.
6	NC -Out 2 -Out 3	Not connected in singles. Negative output 2 in duals. Negative output 3 in triples.
7	NC +Out 2	Not connected in singles. Positive output 2 in duals and triples.
8	-Out 1/Rtn	Negative output 1 in singles and duals. Output return in triples.
9	+Out 1	Positive output 1 in all models.
10	V _{adj}	Output voltage adjust.

Weight

95 gr (3.35 oz)
PKA 2432 PIL 112 gr (3.95 oz)

Case

Blue anodized self-cooled aluminium chassis with snap-on cover and with tin plated brass pins.

Thermal data

Thermal resistance case to ambient
PI-version $R_{th\ case-amb.} = 5.0\ ^\circ C/W$
PIL-version $R_{th\ case-amb.} = 4.6\ ^\circ C/W$

For Off-Card versions (CI) the specification is valid if mounting surface has $R_{th} < 7\ ^\circ C/W$ to ambient.

Electrical Data

Fundamental circuit diagrams

Single output

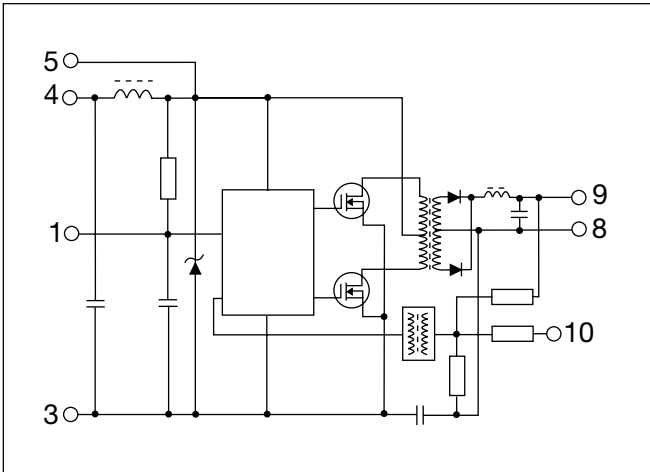

Dual output

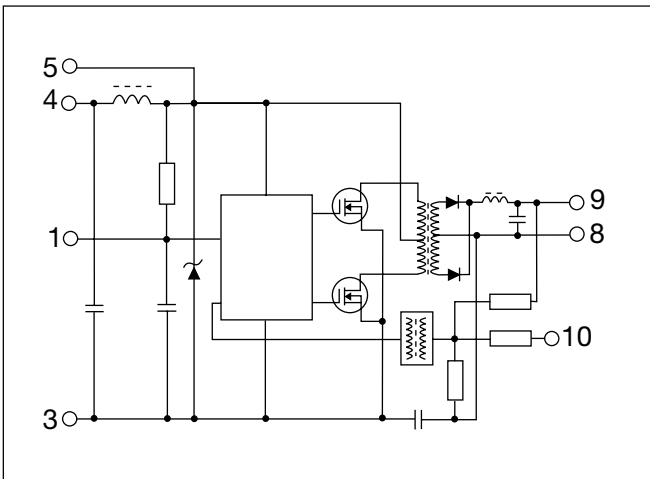

Triple output

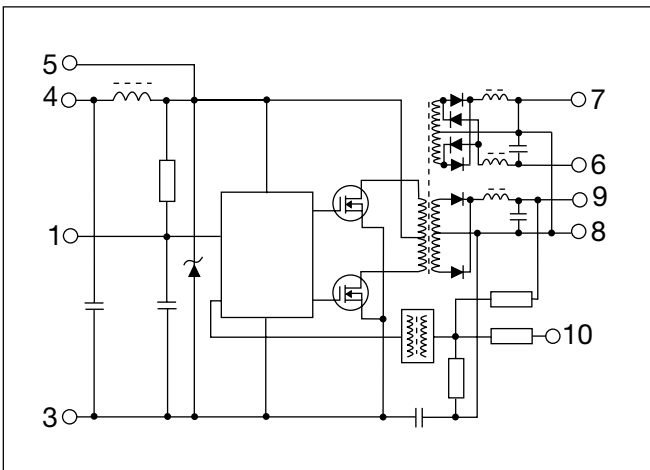

PKA 2211 PI, CI

$T_C = 0...+95^\circ\text{C}$, $V_I = 19...35\text{V}$ unless otherwise specified.

Output

Characteristics		Conditions		Output 1			Unit
				min	typ	max	
V_{O_i}	Output voltage initial setting and accuracy	$T_C = +25^\circ\text{C}$, $I_O = I_{O\text{max}}$, $V_I = 26\text{V}$		5.10	5.13	5.17	V
	Output adjust range ¹⁾			±10			%
V_O	Output voltage tolerance band	Long term drift included	$I_O = 0.1 \dots 1.0 \times I_{O\text{max}}$	5.00		5.36	V
	Idling voltage	$I_O = 25\text{mA}$				5.40	V
	Line regulation	$I_O = I_{O\text{max}}$				72	mV
	Load regulation	$I_O = 0.1 \dots 1.0 \times I_{O\text{max}}$, $V_I = 26\text{V}$				62	mV
t_{tr}	Load transient recovery time	$I_O = 0.1 \dots 1.0 \times I_{O\text{max}}$, $V_I = 26\text{V}$ load step = $0.8 \times I_{O\text{max}}$		100			µs
V_{tr}	Load transient voltage	$\frac{di}{dt} < 0.1\text{A}/\mu\text{s}$		+250			mV
				-250			mV
T_{coeff}	Temperature coefficient ²⁾	$I_O = I_{O\text{max}}$, $T_C < T_{C\text{max}}$		±0.5			mV/°C
t_r	Ramp-up time	$I_O = 0.1 \dots 1.0 \times I_{O\text{max}}$	$0.1 \dots 0.9 \times V_O$	10			ms
t_s	Start-up time		From V_I connection to $V_O = 0.9 \times V_{O_i}$	30			ms
I_O	Output current			0	5.0		A
$P_{O\text{max}}$	Max output power ³⁾			25			W
I_{lim}	Current limiting threshold	$T_C < T_{C\text{max}}$		5.1			A
I_{sc}	Short circuit current ¹⁾						A
$V_{O\text{ac}}$	Output ripple & noise	$I_O = I_{O\text{max}}$	20 Hz ... 5 MHz			90	mV _{p-p}
SVR	Supply voltage rejection (ac)	$f = 100\text{Hz}$ sine wave, $1 V_{p-p}$, $V_I = 26\text{V}$ (SVR = $20 \log(1 V_{p-p}/V_{O\text{p-p}})$)		50			dB

1) See Operating Information.

2) Temperature coefficient is positive at low temperatures.

3) See Typical Characteristics, Power derating.

Miscellaneous

Characteristics		Conditions	min	typ	max	Unit
η	Efficiency	$I_O = I_{O\text{max}}$, $V_I = 26\text{V}$	78	80		%
P_d	Power dissipation	$I_O = I_{O\text{max}}$, $V_I = 26\text{V}$		6.25		W

PKA 2411 PIL

$T_C = 0...+95^{\circ}\text{C}$, $V_I = 19...35\text{ V}$ unless otherwise specified.

Output

Characteristics		Conditions		Output 1			Unit
				min	typ	max	
V_{OI}	Output voltage initial setting and accuracy	$T_C = +25^{\circ}\text{C}$, $I_O = I_{Omax}$, $V_I = 26\text{ V}$		5.10	5.13	5.17	V
	Output adjust range ¹⁾			±10			%
V_O	Output voltage tolerance band	Long term drift included	$I_O = 0.1...1.0 \times I_{Omax}$	5.00		5.36	V
	Idling voltage	$I_O = 25\text{ mA}$				5.40	V
	Line regulation	$I_O = I_{Omax}$				62	mV
	Load regulation	$I_O = 0.1...1.0 \times I_{Omax}$, $V_I = 26\text{ V}$				72	mV
t_{tr}	Load transient recovery time	$I_O = 0.1...1.0 \times I_{Omax}$, $V_I = 26\text{ V}$ load step = $0.8 \times I_{Omax}$			200		µs
V_{tr}	Load transient voltage	$\frac{di}{dt} < 0.1\text{ A}/\mu\text{s}$			+250		mV
					-250		mV
T_{coeff}	Temperature coefficient ²⁾	$I_O = I_{Omax}$, $T_C < T_{Cmax}$			±0.5		mV/°C
t_r	Ramp-up time	$I_O = 0.1...1.0 \times I_{Omax}$	$0.1...0.9 \times V_O$		10		ms
t_s	Start-up time		From V_I connection to $V_O = 0.9 \times V_{OI}$		30		ms
I_O	Output current			0		8.0	A
P_{Omax}	Max output power ³⁾			40			W
I_{lim}	Current limiting threshold	$T_C < T_{Cmax}$		8.15			A
I_{sc}	Short circuit current ¹⁾						A
V_{Oac}	Output ripple & noise	$I_O = I_{Omax}$	20 Hz...5 MHz			90	mV _{p-p}
SVR	Supply voltage rejection (ac)	$f = 100\text{ Hz}$ sine wave, 1 V_{p-p} , $V_I = 26\text{ V}$ ($SVR = 20 \log(1\text{ V}_{p-p}/\text{V}_{O p-p})$)		50			dB

¹⁾ See Operating Information.

²⁾ Temperature coefficient is positive at low temperatures.

³⁾ See Typical Characteristics, Power derating.

Miscellaneous

Characteristics		Conditions	min	typ	max	Unit
η	Efficiency	$I_O = I_{Omax}$, $V_I = 26\text{ V}$	79	81		%
P_d	Power dissipation	$I_O = I_{Omax}$, $V_I = 26\text{ V}$		9.4		W

PKA 2323 PI, CI

$T_C = 0...+95^{\circ}\text{C}$, $V_I = 19...35\text{ V}$ unless otherwise specified. $I_{O1\text{ nom}} = 1.25\text{ A}$, $I_{O2\text{ nom}} = 1.25\text{ A}$.

Output

Characteristics		Conditions		Output 1			Output 2			Unit
				min	typ	max	min	typ	max	
V_{O1}	Output voltage initial setting and accuracy	$T_C = +25^{\circ}\text{C}$, $I_O = I_{O\text{ nom}}$, $V_I = 26\text{ V}$		11.74	11.97	12.20	11.77	12.00	12.23	V
	Output adjust range ¹⁾			±10						%
V_O	Output voltage tolerance band	Long term drift included	$I_{O1} = 0.1...1.0 \times I_{O1\text{ nom}}$ $I_{O2} = I_{O2\text{ nom}}$	11.48		12.57				V
	Idling voltage	$I_O = 25\text{ mA}$				12.50		15.90		V
	Line regulation	$I_O = I_{O\text{ nom}}$				168		192		mV
	Load regulation	$I_{O1} = 0.1...1.0 \times I_{O1\text{ nom}}$, $I_{O2} = I_{O2\text{ nom}}$, $V_I = 26\text{ V}$				144				mV
t_{tr}	Load transient recovery time	$I_O = 0.1...1.0 \times I_{O\text{ nom}}$, $V_I = 26\text{ V}$ load step = $0.8 \times I_{O\text{ nom}}$, $I_{O1} = I_{O2}$				200		200		µs
V_{tr}	Load transient voltage	$\frac{di}{dt} < 0.1\text{ A}/\mu\text{s}$				+600		+600		mV
						-600		-600		mV
T_{coeff}	Temperature coefficient ²⁾	$I_O = I_{O\text{ nom}}$, $T_C < T_{C\text{ max}}$				±1.2		±1.2		mV/°C
t_r	Ramp-up time	$I_O = 0.1...1.0 \times I_{O\text{ nom}}$	$0.1...0.9 \times V_O$			10		10		ms
t_s	Start-up time		From V_I connection to $V_O = 0.9 \times V_{O1}$			30		30		ms
I_O	Output current			0		2.0	0	2.0		A
$P_{O\text{ max}}$	Max total output power ³⁾	Calculated value		min 30, max 15 on Out 2						W
I_{lim}	Current limiting threshold	$T_C < T_{C\text{ max}}$		min $1.02 \times P_{O\text{ max}}^4)$						
I_{sc}	Short circuit current ¹⁾									A
$V_{O\text{ ac}}$	Output ripple & noise	$I_O = I_{O\text{ nom}}$	20 Hz...5MHz			140		140		mV _{p-p}
SVR	Supply voltage rejection (ac)	$f = 100\text{ Hz}$ sine wave, $1 V_{p-p}$, $V_I = 26\text{ V}$ ($\text{SVR} = 20 \log(1 V_{p-p}/V_{O\text{ p-p}})$)		43			43			dB

1) See Operating Information.

2) Temperature coefficient is neutral at low temperatures.

3) See Typical Characteristics, Power derating.

4) I_{lim} on each output is set by the total load.

Miscellaneous

Characteristics		Conditions		min	typ	max	Unit
η	Efficiency	$I_O = I_{O\text{ nom}}$, $V_I = 26\text{ V}$		84	86		%
P_d	Power dissipation	$I_O = I_{O\text{ nom}}$, $V_I = 26\text{ V}$			4.9		W

PKA 2325 PI, CI

$T_C = 0 \dots +95^\circ\text{C}$, $V_I = 19 \dots 35 \text{ V}$ unless otherwise specified. $I_{O1 \text{ nom}} = 1.0 \text{ A}$, $I_{O2 \text{ nom}} = 1.0 \text{ A}$.

Output

Characteristics		Conditions		Output 1			Output 2			Unit
				min	typ	max	min	typ	max	
V_{O1}	Output voltage initial setting and accuracy	$T_C = +25^\circ\text{C}$, $I_O = I_{O \text{ nom}}$, $V_I = 26 \text{ V}$		14.66	14.96	15.26	14.68	14.98	15.28	V
	Output adjust range ¹⁾			±10						%
V_O	Output voltage tolerance band	Long term drift included	$I_{O1} = 0.1 \dots 1.0 \times I_{O \text{ nom}}$ $I_{O2} = I_{O2 \text{ nom}}$	14.35		15.64				V
	Idling voltage	$I_O = 25 \text{ mA}$				15.50		20.00		V
	Line regulation	$I_O = I_{O \text{ nom}}$				210		240		mV
	Load regulation	$I_{O1} = 0.1 \dots 1.0 \times I_{O1 \text{ nom}}$, $I_{O2} = I_{O \text{ nom}}$, $V_I = 26 \text{ V}$				180				mV
t_{tr}	Load transient recovery time	$I_O = 0.1 \dots 1.0 \times I_{O \text{ nom}}$, $V_I = 26 \text{ V}$ load step = $0.8 \times I_{O \text{ nom}}$, $I_{O1} = I_{O2}$		200		200				µs
V_{tr}	Load transient voltage	$\frac{di}{dt} < 0.1 \text{ A}/\mu\text{s}$		+750		+750				mV
				-750		-750				mV
T_{coeff}	Temperature coefficient ²⁾	$I_O = I_{O \text{ nom}}$, $T_C < T_{C \text{ max}}$		±1.5		±1.5				mV/°C
t_r	Ramp-up time	$I_O = 0.1 \dots 1.0 \times I_{O \text{ nom}}$	$0.1 \dots 0.9 \times V_O$	10		10				ms
t_s	Start-up time		From V_I connection to $V_O = 0.9 \times V_{O1}$		30		30			
I_O	Output current			0	1.6		0	1.6		A
$P_{O \text{ max}}$	Max total output power ³⁾			min 30, max 15 on Out 2						W
I_{lim}	Current limiting threshold	$T_C < T_{C \text{ max}}$		min $1.02 \times P_{O \text{ max}}^4)$						
I_{sc}	Short circuit current ¹⁾									A
$V_{O \text{ ac}}$	Output ripple & noise	$I_O = I_{O \text{ nom}}$	20 Hz ... 5 MHz	140		140				mV _{p-p}
SVR	Supply voltage rejection (ac)	f = 100 Hz sine wave, 1 V _{p-p} , $V_I = 26 \text{ V}$ (SVR = $20 \log(1 \text{ V}_{p-p}/V_{O \text{ p-p}})$)		43		43				dB

1) See Operating Information.

2) Temperature coefficient is neutral at low temperatures.

3) See Typical Characteristics, Power derating.

4) I_{lim} on each output is set by the total load.

Miscellaneous

Characteristics		Conditions	min	typ	max	Unit
η	Efficiency	$I_O = I_{O \text{ nom}}$, $V_I = 26 \text{ V}$	82	85		%
P_d	Power dissipation	$I_O = I_{O \text{ nom}}$, $V_I = 26 \text{ V}$		5.3		W

PKA 2231 PI, CI

$T_C = 0 \dots +95^\circ\text{C}$, $V_I = 19 \dots 35 \text{ V}$ unless otherwise specified. $I_{O1\text{nom}} = 3.8 \text{ A}$, $I_{O2, 3\text{nom}} = 0.25 \text{ A}$.

Output

Characteristics		Conditions		Output 1			Output 2			Output 3			Unit
				min	typ	max	min	typ	max	min	typ	max	
V_{OI}	Output voltage initial setting and accuracy	$T_C = +25^\circ\text{C}$, $I_O = I_{O\text{nom}}$, $V_I = 26 \text{ V}$		5.10	5.13	5.17	11.85 ±4%			11.85 ±4%			V
	Output adjust range ¹⁾			±10									
V_O	Output voltage tolerance band	Long term drift included	$I_O = 0.1 \dots 1.0 \times I_{O\text{nom}}$, $I_{O2, 3} = I_{O\text{nom}}$		5.00		5.34					V	
	Idling voltage	$I_O = 25 \text{ mA}$		5.50		15.90		15.90			V		
	Line regulation	$I_O = I_{O\text{nom}}$		62		168		168			mV		
	Load regulation	$I_{O1} = 0.1 \dots 1.0 \times I_{O\text{nom}}$, $I_{O2, 3} = I_{O\text{nom}}$, $V_I = 26 \text{ V}$		52								mV	
t_{tr}	Load transient recovery time	$I_O = 0.1 \dots 1.0 \times I_{O\text{nom}}$, $V_I = 26 \text{ V}$ load step = 80% of $I_{O\text{nom}}$ symmetrical load, $I_{O2, 3} = I_{O\text{nom}}$		100		100		100			µs		
V_{tr}	Load transient voltage	$\frac{di}{dt} < 0.1 \text{ A}/\mu\text{s}$		+250		+650		+650			mV		
				-250		-650		-650			mV		
T_{coeff}	Temperature coefficient ²⁾	$I_O = I_{O\text{nom}}$, $T_C < T_{C\text{max}}$		±0.5		±1.2		±1.2			mV/°C		
t_r	Ramp-up time	$I_O = 0.1 \dots 1.0 \times I_{O\text{nom}}$, $V_I = 26 \text{ V}$	$0.1 \dots 0.9 \times V_O$		10		10		10			ms	
t_s	Start-up time	$V_I = 26 \text{ V}$		From V_I connection to $V_O = 0.9 \times V_{OI}$		30		30		30			ms
I_O	Output current			0		5		0		1		A	
$P_{O\text{max}}$	Max total output power ³⁾			min 25, max 15 on Out 2 + Out 3								W	
I_{lim}	Current limiting threshold	$T_C < T_{C\text{max}}$		min $1.02 \times P_{O\text{max}}^4)$									
I_{sc}	Short circuit current ¹⁾											A	
$V_{O\text{ac}}$	Output ripple & noise	$I_O = I_{O\text{nom}}$	20 Hz...5 MHz		90		150		150			mV _{p-p}	
SVR	Supply voltage rejection (ac)	f = 100 Hz sine wave, 1 V _{p-p} , $V_I = 26 \text{ V}$ (SVR = $20 \log(1 \text{ V}_{p-p}/V_{O\text{p-p}})$)		50		43		43			dB		

¹⁾ See Operating Information.

²⁾ Temperature coefficient is neutral at low temperatures.

³⁾ See Typical Characteristics, Power derating.

⁴⁾ I_{lim} on each output is set by the total load.

Miscellaneous

Characteristics		Conditions	min	typ	max	Unit
η	Efficiency	$I_O = I_{O\text{nom}}$, $V_I = 26 \text{ V}$	78	82		%
P_d	Power dissipation	$I_O = I_{O\text{nom}}$, $V_I = 26 \text{ V}$		5.5		W

PKA 2232 PI, CI

$T_C = 0 \dots +95^\circ\text{C}$, $V_I = 19 \dots 35 \text{ V}$ unless otherwise specified. $I_{O1\text{nom}} = 3.8 \text{ A}$, $I_{O2,3\text{nom}} = 0.2 \text{ A}$.

Output

Characteristics		Conditions		Output 1			Output 2			Output 3			Unit
				min	typ	max	min	typ	max	min	typ	max	
V_{O1}	Output voltage initial setting and accuracy	$T_C = +25^\circ\text{C}$, $I_O = I_{O\text{nom}}$, $V_I = 26 \text{ V}$		5.10	5.13	5.17	14.25	15.00	15.75	-14.75	-15.00	-15.75	V
	Output adjust range ¹⁾			±10									%
V_O	Output voltage tolerance band	Long term drift included	$I_O = 0.1 \dots 1.0 \times I_{O\text{nom}}$, $I_{O2,3} = I_{O\text{nom}}$	5.00			5.33						V
	Idling voltage	$I_O = 25 \text{ mA}$		5.5			21.8			21.8			V
	Line regulation	$I_O = I_{O\text{nom}}$		62			240			240			mV
	Load regulation	$I_{O1} = 0.1 \dots 1.0 \times I_{O\text{nom}}$, $I_{O2,3} = I_{O\text{nom}}$, $V_I = 26 \text{ V}$		52									mV
t_{tr}	Load transient recovery time	$I_O = 0.1 \dots 1.0 \times I_{O\text{nom}}$, $V_I = 26 \text{ V}$ load step = 80% of $I_{O\text{nom}}$ symmetrical load, $I_{O2,3} = I_{O\text{nom}}$		100			100			100			µs
V_{tr}	Load transient voltage	$\frac{di}{dt} < 0.1 \text{ A}/\mu\text{s}$		+250			+750			+750			mV
				-250			-750			-750			mV
T_{coeff}	Temperature coefficient ²⁾	$I_O = I_{O\text{nom}}$, $T_C < T_{C\text{max}}$		±0.5			±1.5			±1.5			mV/°C
t_r	Ramp-up time	$I_O = 0.1 \dots 1.0 \times I_{O\text{nom}}$, $V_I = 26 \text{ V}$	$0.1 \dots 0.9 \times V_O$	10			10			10			ms
t_s	Start-up time	From V_I connection to $V_O = 0.9 \times V_{O1}$		30			30			30			ms
I_O	Output current			0	5.0		0	0.8		0	0.8		A
$P_{O\text{max}}$	Max total output power ³⁾			min 25, max 15 on Out 2 + Out 3								W	
I_{lim}	Current limiting threshold	$T_C < T_{C\text{max}}$		min $1.02 \times P_{O\text{max}}^4)$									
I_{sc}	Short circuit current ¹⁾												A
$V_{O\text{ac}}$	Output ripple & noise	$I_O = I_{O\text{nom}}$	20 Hz...5 MHz	90			150			150			mV _{p-p}
SVR	Supply voltage rejection (ac)	f = 100 Hz sine wave, 1 V _{p-p} , $V_I = 26 \text{ V}$ (SVR = $20 \log(1 \text{ V}_{p-p}/V_{O\text{p-p}})$)		50			40			40			dB

1) See Operating Information.

2) Temperature coefficient is neutral at low temperatures.

3) See Typical Characteristics, Power derating.

4) I_{lim} on each output is set by the total load.

Miscellaneous

Characteristics		Conditions	min	typ	max	Unit
η	Efficiency	$I_O = I_{O\text{nom}}$, $V_I = 26 \text{ V}$	78	83		%
P_d	Power dissipation	$I_O = I_{O\text{nom}}$, $V_I = 26 \text{ V}$		5.1		W

PKA 2432 PIL

$T_C = 0 \dots +95^\circ\text{C}$, $V_I = 19 \dots 35 \text{ V}$ unless otherwise specified. $I_{O1 \text{ nom}} = 5.0 \text{ A}$, $I_{O2, 3 \text{ nom}} = 0.45 \text{ A}$.

Output

Characteristics		Conditions		Output 1			Output 2			Output 3			Unit
				min	typ	max	min	typ	max	min	typ	max	
V_{O_i}	Output voltage initial setting and accuracy	$T_C = +25^\circ\text{C}$, $I_O = I_{O \text{ nom}}$, $V_I = 26 \text{ V}$		5.03	5.13	5.24	15.84	16.50	17.16	-15.84	-16.50	-17.16	V
	Output adjust range ¹⁾			±10									%
V_O	Output voltage tolerance band	Long term drift included	$I_O = 0.1 \dots 1.0 \times I_{O \text{ nom}}$, $I_{O2, 3} = I_{O \text{ nom}}$	4.82	5.52								V
	Idling voltage	$I_O = 25 \text{ mA}$		5.4		23.0			23.0			V	
	Line regulation	$I_O = I_{O \text{ nom}}$		185		725			725			mV	
	Load regulation	$I_{O1} = 0.1 \dots 1.0 \times I_{O \text{ nom}}$, $I_{O2, 3} = I_{O \text{ nom}}$, $V_I = 26 \text{ V}$		54								mV	
t_{tr}	Load transient recovery time	$I_O = 0.1 \dots 1.0 \times I_{O \text{ nom}}$, $V_I = 26 \text{ V}$ load step = 80% of $I_{O \text{ nom}}$ symmetrical load, $I_{O2, 3} = I_{O \text{ nom}}$		100		100			100			µs	
V_{tr}	Load transient voltage	$\frac{di}{dt} < 0.1 \text{ A}/\mu\text{s}$		+250		+830			+830			mV	
				-250		-830			-830			mV	
T_{coeff}	Temperature coefficient ²⁾	$I_O = I_{O \text{ nom}}$, $T_C < T_{C \text{ max}}$		±0.5		±1.7			±1.7			mV/°C	
t_r	Ramp-up time	$I_O = 0.1 \dots 1.0 \times I_{O \text{ nom}}$, $V_I = 26 \text{ V}$	$0.1 \dots 0.9 \times V_O$	10		10			10			ms	
t_s	Start-up time			30		30			30			ms	
I_O	Output current			0	8.0		0	2.0		0	2.0		A
$P_{O \text{ max}}$	Max total output power ³⁾			min 40, max 25 on Out 2 + Out 3								W	
I_{lim}	Current limiting threshold	$T_C < T_{C \text{ max}}$		min $1.02 \times P_{O \text{ max}}^4)$									
I_{sc}	Short circuit current ¹⁾											A	
$V_{O \text{ ac}}$	Output ripple & noise	$I_O = I_{O \text{ nom}}$	20 Hz ... 5 MHz	90		150			150			mV _{p-p}	
SVR	Supply voltage rejection (ac)	f = 100 Hz sine wave, 1 V _{p-p} , $V_I = 26 \text{ V}$ (SVR = $20 \log(1 \text{ V}_{p-p}/V_{O \text{ p-p}})$)		40		30			30			dB	

¹⁾ See Operating Information.

²⁾ Temperature coefficient is neutral at low temperatures.

³⁾ See Typical Characteristics, Power derating.

⁴⁾ I_{lim} on each output is set by the total load.

Miscellaneous

Characteristics		Conditions	min	typ	max	Unit
η	Efficiency	$I_O = I_{O \text{ nom}}$, $V_I = 26 \text{ V}$	81	83		%
P_d	Power dissipation	$I_O = I_{O \text{ nom}}$, $V_I = 26 \text{ V}$		8.2		W

PKA2211 PI, CI

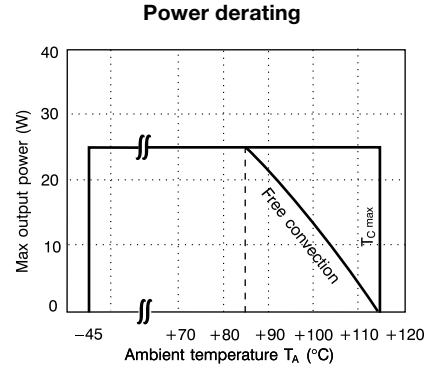
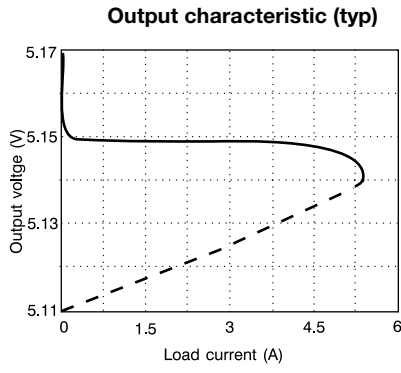
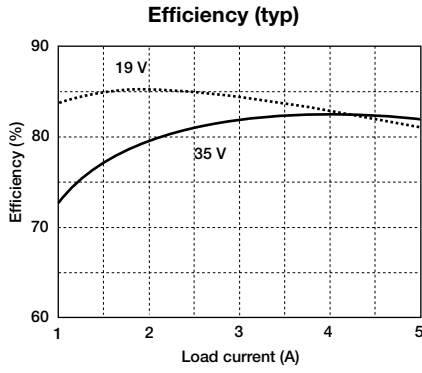

PKA 2411 PIL

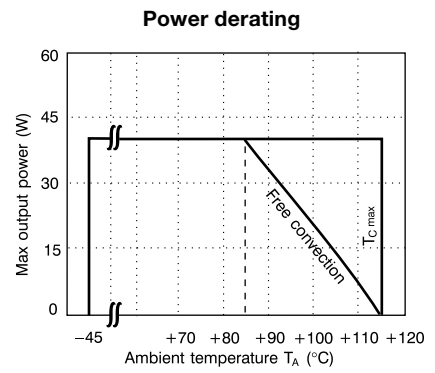
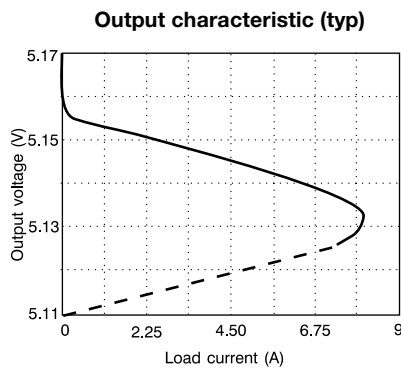
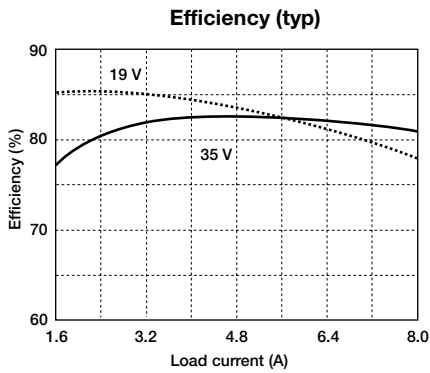

PKA 2323 PI, CI

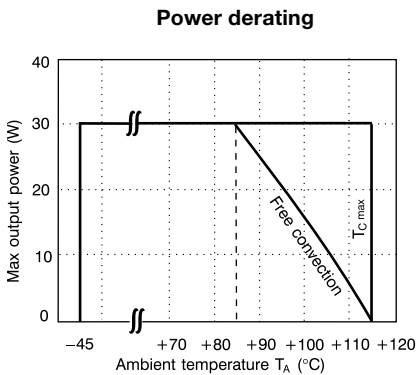
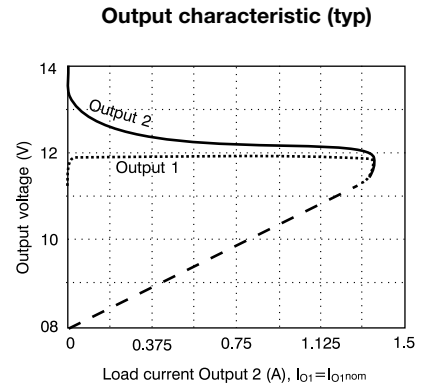
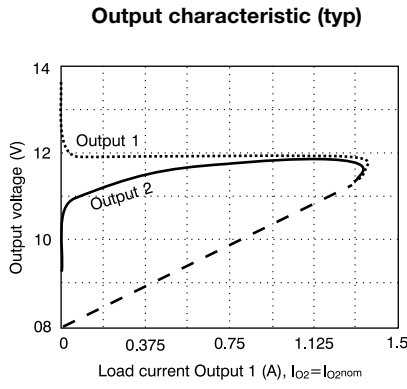
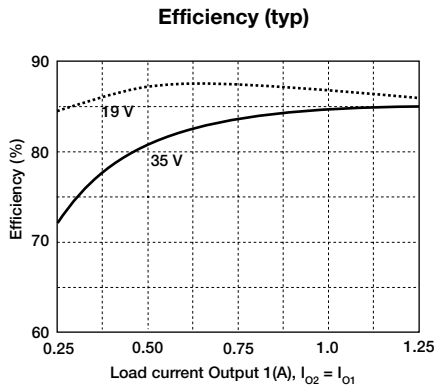

PKA 2325 PI, CI

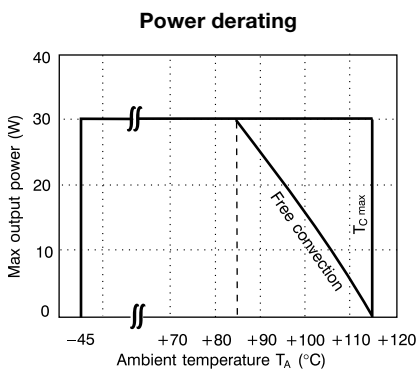
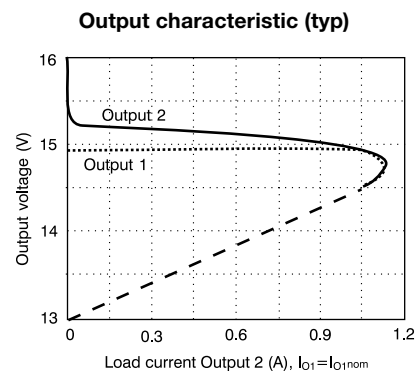
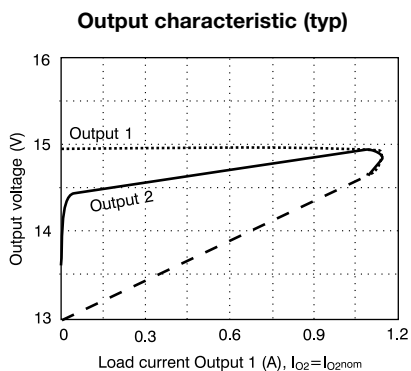
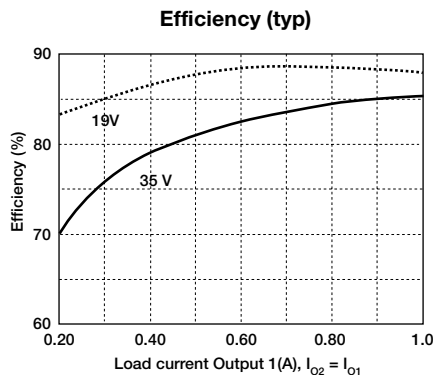

PKA 2231 PI, CI

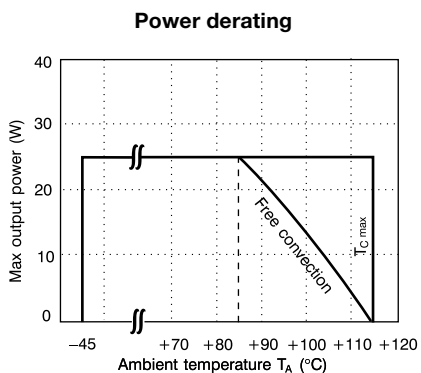
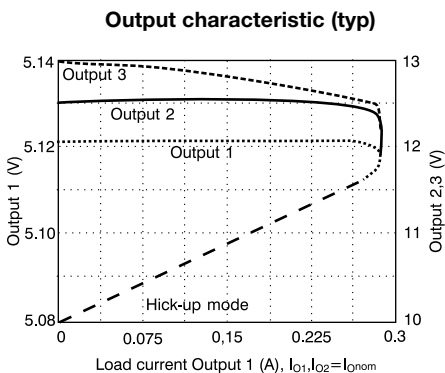
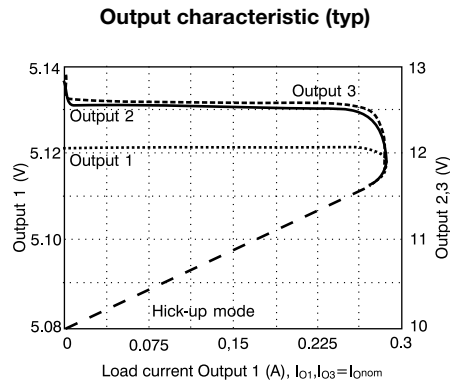
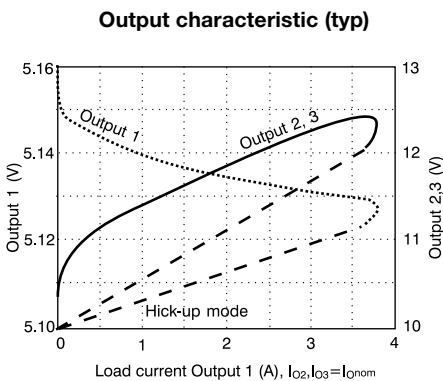
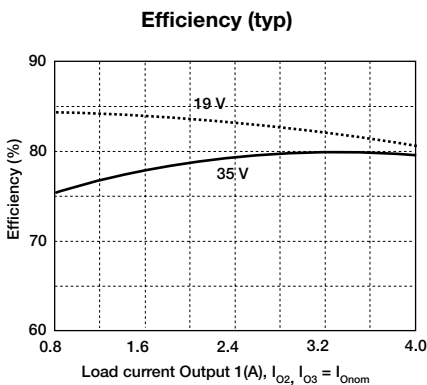

PKA 2232 PI, CI

Efficiency (typ)

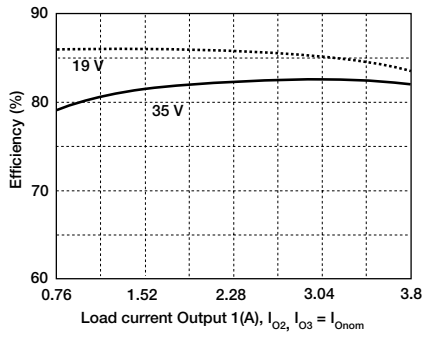

Output characteristic (typ)

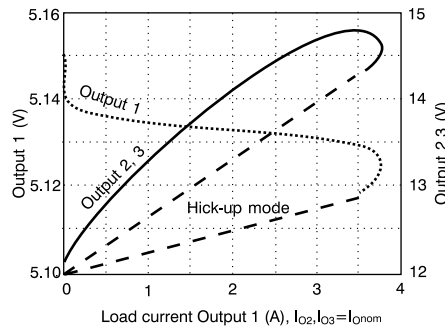

Output characteristic (typ)

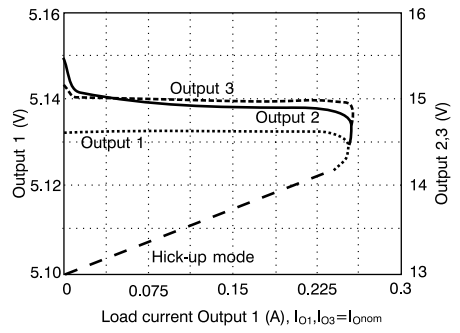

Output characteristic (typ)

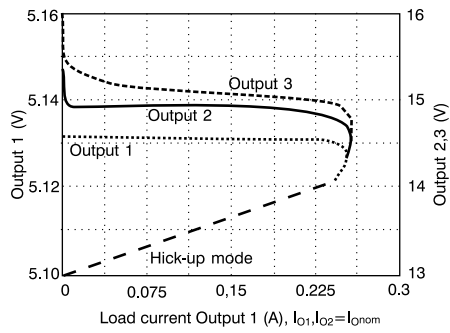

Power derating

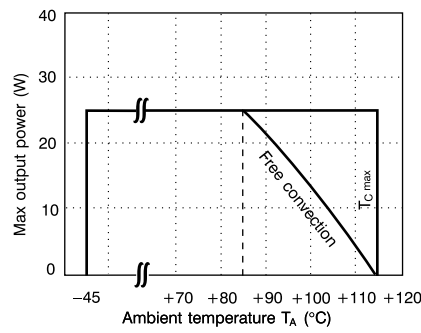

PKA 2432 PIL

Efficiency (typ)

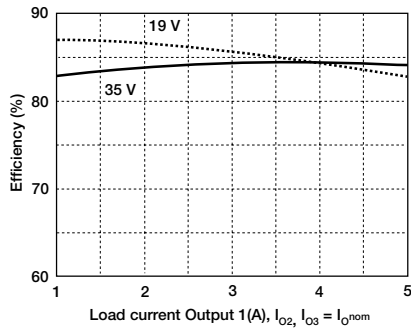

Output characteristic (typ)

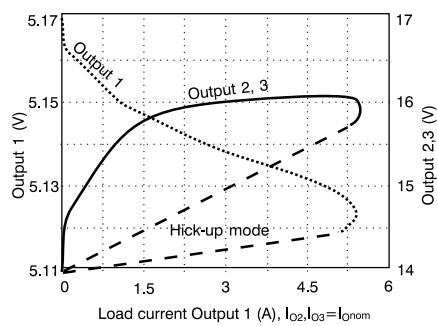

Output characteristic (typ)

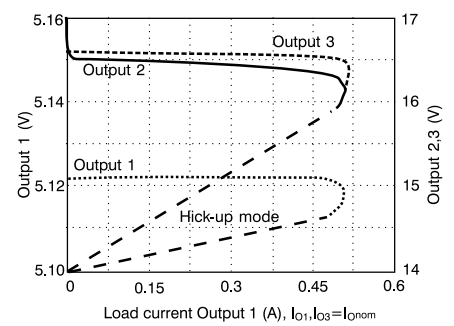

Output characteristic (typ)

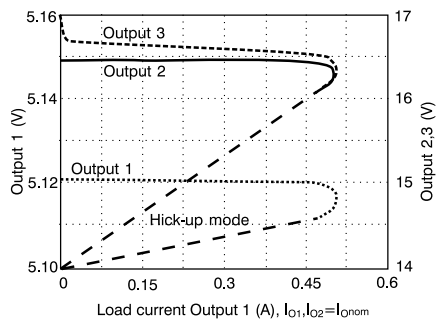

Power derating

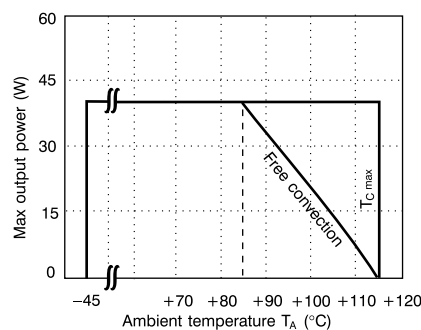

EMC Specifications

The conducted EMI measurement was performed using a module placed directly on the test bench.
The fundamental switching frequency is $300 \text{ kHz} \pm 15\%$ @ $V_I = 26\text{V}$,
 $I_O = (0.1 \dots 1.0) \times I_{Omax}$.

Conducted EMI Input terminal value (typ)

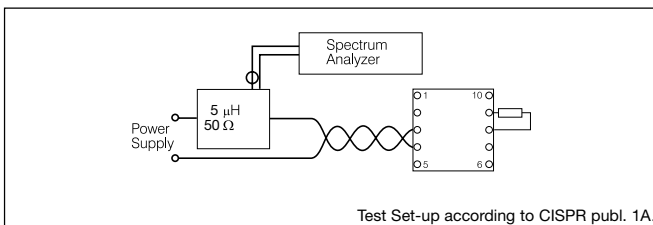
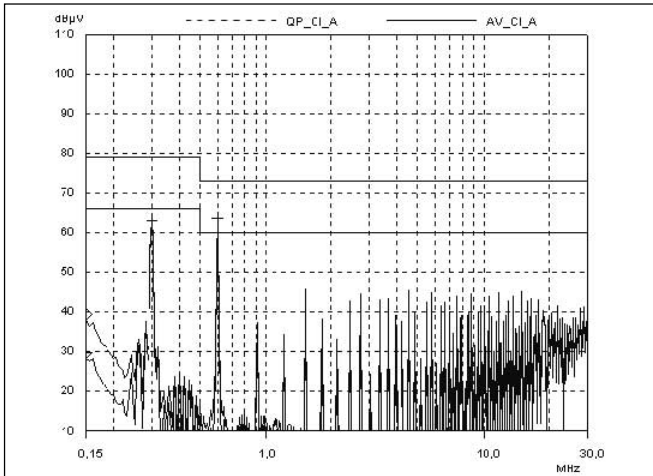

Output Ripple (V_{Oac})

Output ripple is measured as the peak to peak voltage of the fundamental switching frequency.

Operating information

Remote Control (RC)

Turn-on or turn-off can be realized by using the RC-pin. Normal operation is achieved if pin 1 is open (NC). If pin 1 is connected to pin 3 the PKA DC/DC power module turns off. To ensure safe turn-off the voltage difference between pin 1 and 3 shall be less than 1.8 V. RC is TTL open collector compatible (see fig. 1). Pin 1 is an output and no current should be driven into pin 1. Use a diode if necessary e.g. totem pole TTL logic. The internal pull-up resistance is 36 kΩ.

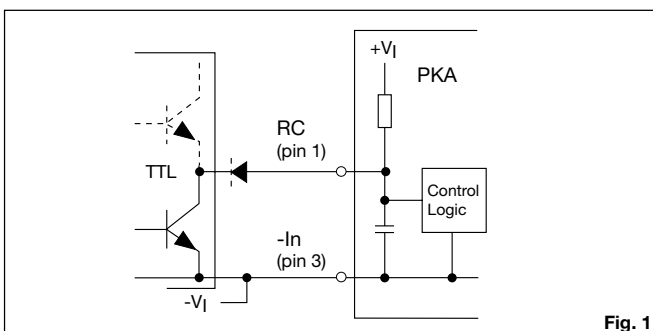

Fig. 1

Over Voltage Protection (OVP)

The remote control can also be utilized for OVP by using the external circuitry in fig. 2. Resistor values given are for 5 V output applications, but can easily be adjusted for other output voltages and the desired OVP level.

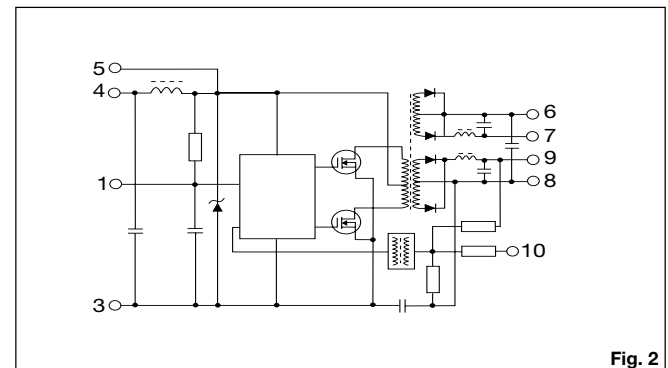

Fig. 2

Maximum Capacitive Load

The maximum recommended capacitance connected directly to the PKA DC/DC power modules' output, without resistance or inductance in series, is 100 µF/A (output current rating). Connect capacitors across the load for maximum effectiveness and maximum stability margins.

Turn-off Input Voltage (V_{Ioff})

The input voltage is monitored and the PKA DC/DC power module will turn on and turn off at predetermined levels. The levels can be decreased by means of an external resistor connected between pin 1 and pin 4.

A 200 kΩ resistor will decrease the shutdown voltage below 18 V. To maintain the nominal output voltage at input voltages below V_{Imin} it may be necessary to decrease the load.

Output Voltage Adjust (V_{adj})

The output voltage, V_O , can be adjusted by using an external resistor. The output voltage adjust function is not accurate and it is recommended to use a potentiometer. To decrease the output voltage the resistor should be connected between pin 10 and pin 9 (+ Out 1). To increase the output voltage the resistor should be connected between pin 10 and pin 8 (- Out 1).

Parallel Operation

Due to the current limiting protection (hick-up), temperature coefficient and output voltage characteristic for PKA paralleling of modules for increased power is not recommended. PKA can be paralleled for redundancy.

Current Limiting Protection

The output power is limited at loads above the output current limiting threshold (I_{lim}), specified as a minimum value.

As the PKA multiple output models are power limited, current limiting threshold for an individual output is set by the loads on the other outputs. The power module can withstand continuous short circuit without destruction. A hick-up mode is used on all models to minimize the internal power dissipation. The hick-up time constant is set by the slow start.

Input and Output Impedance

Both the source impedance of the power feeding and the load impedance will interact with the impedance of the DC/DC power module. It is most important to have the ratio between L and C as low as possible, i.e. a low characteristic impedance, both at the input and output, as the power modules have a low energy storage capability. Use an electrolytic capacitor across the input or output if the source or load inductance is larger than 10 μH . Their equivalent series resistance together with the capacitance acts as a lossless damping filter. Suitable capacitor values are in the range 10–100 μF .

Accessories

PKZ 0001 PI version of ground pin for case, in packages of 10 pcs incl. mounting screws.

PKZ 0004 Mounting bracket for Off-Card mounting in packages of 2 pcs.

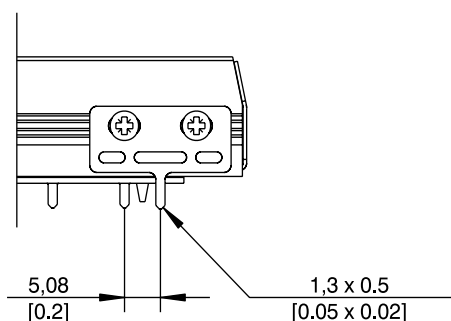

Mounting information for PKZ 0001

The two holes on the ground pin are ovals for positioning of the pin according to the PCB layout. The screws are delivered together with the pin.

Mounting information for PKZ 0004

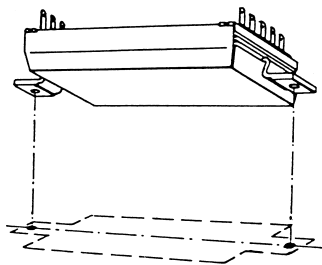

Mounting surface must be flat within 0.2 mm. All specifications are valid if the mounting surface has $R_{th} < 7^\circ\text{C}/\text{W}$.

Quality

Reliability

Meantime between failure (MTBF) is calculated to >2.0 million hours at full output power and a case temperature of +75°C ($T_A = +45^\circ\text{C}$), using the Ericsson failure rate data system. The Ericsson failure rate data system is based on field failure rates and is continuously updated. The data corresponds to actual failure rates of component used in Information Technology and Telecom equipment in temperature controlled environments ($T_A = -5 \dots +65^\circ\text{C}$). The data is considered to have a confidence level of 90%. For more information see Design Note 002.

Quality Statement

The products are designed and manufactured in an industrial environment where quality systems and methods like ISO 9000, 6s and SPC, are intensively in use to boost the continuous improvements strategy. Infant mortality or early failures in the products are screened out by a burn-in procedure and an ATE-based final test. Conservative design rules, design reviews and product qualifications, plus the high competence of an engaged work force, contribute to the high quality of our products.

Warranty

Ericsson Microelectronics warrants to the original purchaser or end user that the products conform to this Data Sheet and are free from material and workmanship defects for a period of five (5) years from the date of manufacture, if the product is used within specified conditions and not opened. In case the product is discontinued, claims will be accepted up to three (3) years from the date of the discontinuation. For additional details on this limited warranty we refer to Ericsson Microelectronics AB's "General Terms and Conditions of Sales", or individual contract documents.

Limitation of Liability

Ericsson Microelectronics does not make any other warranties, expressed or implied including any warranty of merchantability or fitness for a particular purpose (including, but not limited to, use in life support applications, where malfunctions of product can cause injury to a person's health or life).

Information given in this data sheet is believed to be accurate and reliable. No responsibility is assumed for the consequences of its use nor for any infringement of patents or other rights of third parties which may result from its use. No license is granted by implication or otherwise under any patent or patent rights of Ericsson Microelectronics. These products are sold only according to Ericsson Microelectronics' general conditions of sale, unless otherwise confirmed in writing. Specifications subject to change without notice.

Product Program

V _I	V _O /I _O max		P _O max	Ordering No.	
	Output 1	Output 2/3		On-Card	Off-Card
24 V	5 V/5 A		25 W	PKA 2211 PI	PKA 2211 CI
	5 V/8 A		40 W	PKA 2411 PIL	
	12 V/2 A	12 V/2 A	30 W	PKA 2323 PI	PKA 2323 CI
	15 V/1.6 A	15 V/1.6 A	30 W	PKA 2325 PI	PKA 2325 CI
	+5 V/5 A	±12 V/1 A	25 W	PKA 2231 PI	PKA 2231 CI
	+5 V/5 A	±15 V/0.8 A	25 W	PKA 2232 PI	PKA 2232 CI
	+5 V/8 A	±15 V/2 A	40 W	PKA 2432 PIL	

Ericsson Microelectronics AB
 SE-164 81 KISTA, Sweden
 Phone: +46 8 757 5000
www.ericsson.com/microelectronics

For local sales contacts, please refer to our website
 or call: Int. +46 8 757 4700, Fax: +46 8 757 4776

The latest and most complete information can be found on our website!

Data Sheet

EN/LZT 146 09 R1A

© Ericsson Microelectronics AB, June 2000