

## Surface Mount Automotive Transient Voltage Suppressors

High Temperature Stability and High Reliability Conditions

Patented\*



\*Patent #'s  
4,980,315  
5,166,769  
5,278,094

DO-214AC (SMA)

### FEATURES

- Patented PAR<sup>®</sup> construction
- Available in uni-directional polarity only
- 400 W peak pulse power capability with a 10/1000  $\mu$ s waveform, repetitive rate (duty cycle): 0.01 %
- Excellent clamping capability
- Very fast response time
- Low incremental surge resistance
- Meets MSL level 1, per J-STD-020C, LF max peak of 260 °C
- Solder dip 260 °C, 40 seconds
- Component in accordance to RoHS 2002/95/EC and WEEE 2002/96/EC



### TYPICAL APPLICATIONS

Use in sensitive electronics protection against voltage transients induced by inductive load switching and lighting on ICs, MOSFET, signal lines of sensor units for consumer, computer, industrial, automotive and telecommunication.

### MECHANICAL DATA

**Case:** DO-214AC (SMA)

Epoxy meets UL 94V-0 flammability rating

**Terminals:** Matte tin plated leads, solderable per J-STD-002B and JESD22-B102D

HE3 suffix for high reliability grade (AEC Q101 qualified)

**Polarity:** Color band denotes cathode end

PRIMARY CHARACTERISTICS	
$V_{BR}$	6.8 V to 43 V
$P_{PPM}$	400 W
$P_D$	1.0 W
$I_{FSM}$	40 A
$T_J$ max.	185 °C

MAXIMUM RATINGS ( $T_A = 25$ °C unless otherwise noted)			
PARAMETER	SYMBOL	VALUE	UNIT
Peak power dissipation with a 10/1000 $\mu$ s waveform <sup>(1)(2)</sup> (Fig. 3)	$P_{PPM}$	400	W
Peak power pulse current with a 10/1000 $\mu$ s waveform <sup>(1)</sup> (Fig. 1)	$I_{PPM}$	See next table	A
Power dissipation at $T_A = 25$ °C <sup>(4)</sup>	$P_D$	1.0	W
Peak forward surge current 8.3 ms single half sine-wave <sup>(3)</sup>	$I_{FSM}$	40	A
Maximum instantaneous forward voltage at 25 A <sup>(3)</sup>	$V_F$	3.5	V
Operating junction and storage temperature range	$T_J, T_{STG}$	- 65 to + 185	°C

#### Notes:

- (1) Non-repetitive current pulse, per Fig. 3 and derated above  $T_A = 25$  °C per Fig. 2
- (2) Mounted on P.C.B. with 0.2 x 0.2" (5.0 x 5.0 mm) copper pads attached to each terminal
- (3) Measured on 8.3 ms single half sine-wave or equivalent square wave, duty cycle = 4 pulses per minutes maximum
- (4) Mounted on minimum recommended pad layout



<b>ELECTRICAL CHARACTERISTICS</b> ( $T_A = 25\text{ }^\circ\text{C}$ unless otherwise noted)									
DEVICE	DEVICE MARKING CODE	BREAKDOWN VOLTAGE $V_{BR}^{(1)}$ AT $I_T$ (V)		TEST CURRENT $I_T$ (mA)	STAND-OFF VOLTAGE $V_{WM}$ (V)	MAXIMUM REVERSE LEAKAGE AT $V_{WM}$ $I_R$ ( $\mu\text{A}$ )	$T_J = 150\text{ }^\circ\text{C}$ MAXIMUM REVERSE LEAKAGE AT $V_{WM}$ $I_D$ ( $\mu\text{A}$ )	MAXIMUM PEAK PULSE SURGE CURRENT $I_{PPM}^{(2)}$ (A)	MAXIMUM CLAMPING VOLTAGE AT $I_{PPM}$ $V_C$ (V)
		MIN	MAX						
TPSMA6.8	ADP	6.12	7.48	10	5.50	300	1000	37.0	10.8
TPSMA6.8A	AEP	6.45	7.14	10	5.80	300	1000	38.1	10.5
TPSMA7.5	AFP	6.75	8.25	10	6.05	150	500	34.2	11.7
TPSMA7.5A	AGP	7.13	7.88	10	6.40	150	500	35.4	11.3
TPSMA8.2	AHP	7.38	9.02	10	6.63	50	200	32.0	12.5
TPSMA8.2A	AKP	7.79	8.61	10	7.02	50	200	33.1	12.1
TPSMA9.1	ALP	8.19	10.00	1.0	7.37	10	50	29.0	13.8
TPSMA9.1A	AMP	8.65	9.55	1.0	7.78	10	50	29.9	13.0
TPSMA10	ANP	9.00	11.00	1.0	8.10	5.0	20	26.7	15.0
TPSMA10A	APP	9.50	10.50	1.0	8.65	5.0	20	27.6	14.5
TPSMA11	AQP	9.90	12.10	1.0	8.92	1.0	5.0	24.7	16.2
TPSMA11A	ARP	10.50	11.60	1.0	9.40	1.0	5.0	25.6	15.6
TPSMA12	ASP	10.80	13.20	1.0	9.72	1.0	5.0	23.1	17.3
TPSMA12A	ATP	11.40	12.60	1.0	10.20	1.0	5.0	24.0	16.7
TPSMA13	AUP	11.70	14.30	1.0	10.50	1.0	5.0	21.1	19.0
TPSMA13A	AVP	12.40	13.70	1.0	11.10	1.0	5.0	22.0	18.2
TPSMA15	AWP	13.50	16.30	1.0	12.10	1.0	5.0	18.2	22.0
TPSMA15A	AXP	14.30	15.80	1.0	12.80	1.0	5.0	18.9	21.2
TPSMA16	AYP	14.40	17.60	1.0	12.90	1.0	5.0	17.0	23.5
TPSMA16A	AZP	15.20	16.80	1.0	13.60	1.0	5.0	17.8	22.0
TPSMA18	BDP	16.20	19.80	1.0	14.50	1.0	5.0	15.1	26.5
TPSMA18A	BEP	17.10	18.90	1.0	15.30	1.0	5.0	15.9	25.5
TPSMA20	BFP	18.00	22.00	1.0	16.20	1.0	5.0	13.7	29.1
TPSMA20A	BGP	19.00	21.00	1.0	17.10	1.0	5.0	14.4	27.7
TPSMA22	BHP	19.80	24.20	1.0	17.80	1.0	5.0	12.5	31.9
TPSMA22A	BKP	20.90	23.10	1.0	18.80	1.0	5.0	13.1	30.6
TPSMA24	BLP	21.60	26.40	1.0	19.40	1.0	5.0	11.5	34.7
TPSMA24A	BMP	22.80	25.20	1.0	20.50	1.0	5.0	12.0	33.2
TPSMA27	BNP	24.30	29.70	1.0	21.80	1.0	5.0	10.2	39.1
TPSMA27A	BPP	25.70	28.40	1.0	23.10	1.0	5.0	10.7	37.5
TPSMA30	BQP	27.00	33.00	1.0	24.30	1.0	5.0	9.2	43.5
TPSMA30A	BRP	28.50	31.50	1.0	25.60	1.0	5.0	9.7	41.4
TPSMA33	BSP	29.70	36.30	1.0	26.80	1.0	5.0	8.4	47.0
TPSMA33A	BTP	31.40	34.70	1.0	28.20	1.0	5.0	8.8	45.7
TPSMA36	BUP	32.40	39.60	1.0	29.10	1.0	5.0	7.7	52.0
TPSMA36A	BVP	34.20	37.80	1.0	30.80	1.0	5.0	8.0	49.9
TPSMA39	BWP	35.10	42.90	1.0	31.60	1.0	5.0	7.1	56.4
TPSMA39A	BXP	37.10	41.00	1.0	33.30	1.0	5.0	7.4	53.9
TPSMA43	BYP	38.70	47.30	1.0	34.80	1.0	5.0	6.5	61.9
TPSMA43A	BZP	40.90	45.20	1.0	36.80	1.0	5.0	6.7	59.3

**Note:**

- (1)  $V_{BR}$  measured after  $I_T$  applied for 300  $\mu\text{s}$ ,  $I_T$  = square wave pulse or equivalent
- (2) Surge current waveform per Fig. 3 and derated per Fig. 2
- (3) All terms and symbols are consistent with ANSI/IEEE C62.35

ORDERING INFORMATION (Example)				
PREFERRED P/N	UNIT WEIGHT (g)	PREFERRED PACKAGE CODE	BASE QUANTITY	DELIVERY MODE
TPSMA6.8AHE3/61T <sup>(1)</sup>	0.064	61T	1800	7" diameter plastic tape and reel
TPSMA6.8AHE3/5AT <sup>(1)</sup>	0.064	5AT	7500	13" diameter plastic tape and reel

**Note:**

(1) Automotive grade AEC Q101 qualified

## RATINGS AND CHARACTERISTICS CURVES

(T<sub>A</sub> = 25 °C unless otherwise noted)

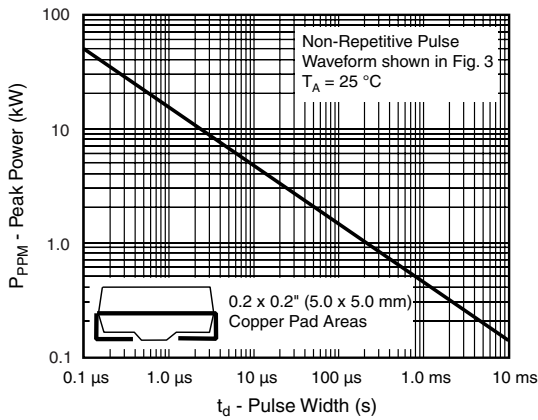

Figure 1. Peak Pulse Power Rating Curve

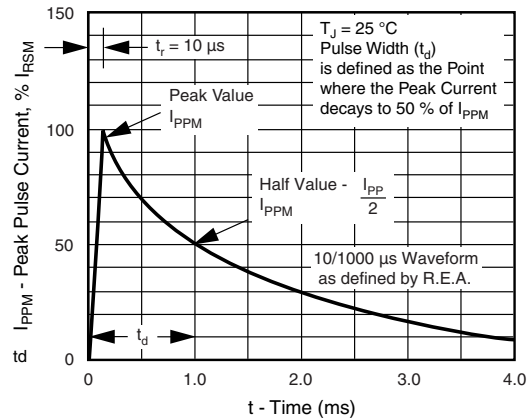

Figure 3. Pulse Waveform

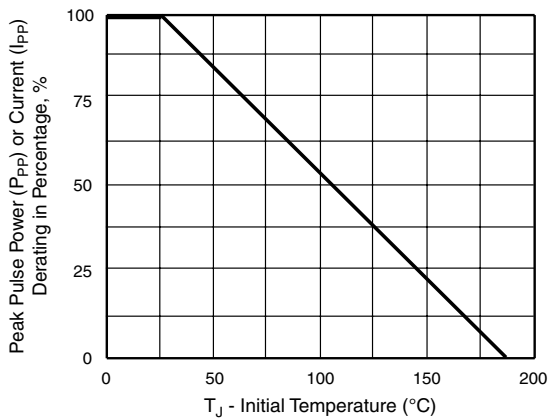

Figure 2. Pulse Power or Current vs. Initial Junction Temperature

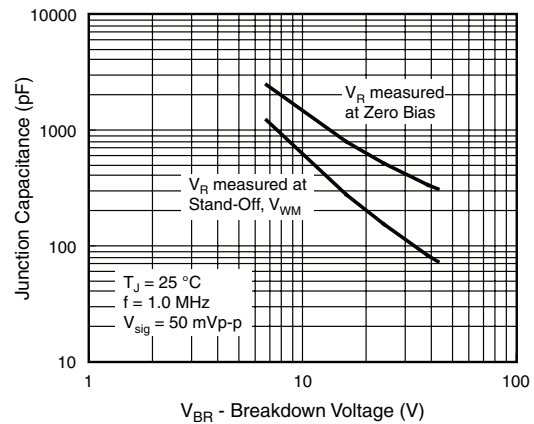

Figure 4. Typical Junction Capacitance

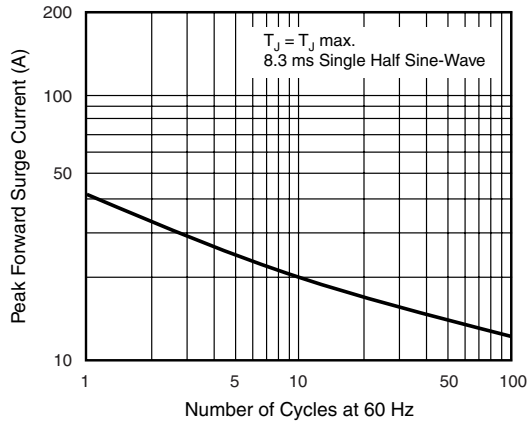
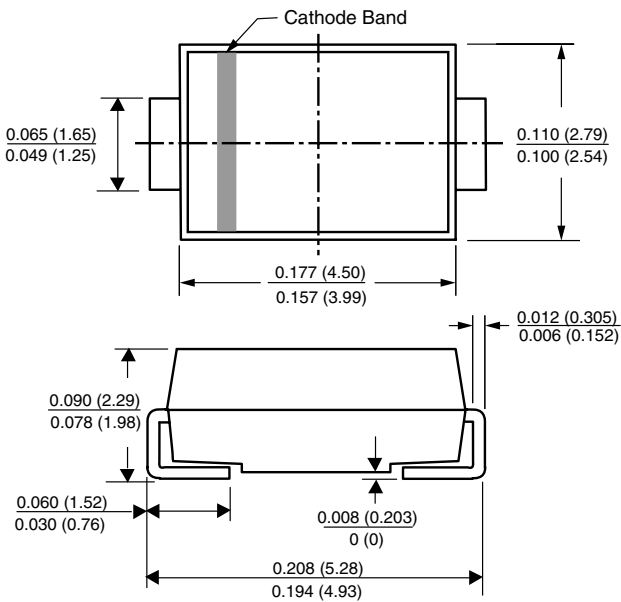

Figure 5. Maximum Non-Repetitive Peak Forward Surge Current

## PACKAGE OUTLINE DIMENSIONS in inches (millimeters)

### DO-214AC (SMA)



### Mounting Pad Layout

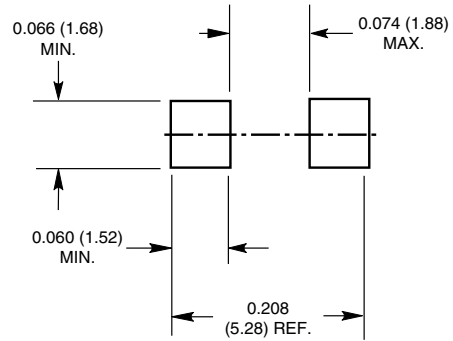



## Disclaimer

All product specifications and data are subject to change without notice.

Vishay Intertechnology, Inc., its affiliates, agents, and employees, and all persons acting on its or their behalf (collectively, "Vishay"), disclaim any and all liability for any errors, inaccuracies or incompleteness contained herein or in any other disclosure relating to any product.

Vishay disclaims any and all liability arising out of the use or application of any product described herein or of any information provided herein to the maximum extent permitted by law. The product specifications do not expand or otherwise modify Vishay's terms and conditions of purchase, including but not limited to the warranty expressed therein, which apply to these products.

No license, express or implied, by estoppel or otherwise, to any intellectual property rights is granted by this document or by any conduct of Vishay.

The products shown herein are not designed for use in medical, life-saving, or life-sustaining applications unless otherwise expressly indicated. Customers using or selling Vishay products not expressly indicated for use in such applications do so entirely at their own risk and agree to fully indemnify Vishay for any damages arising or resulting from such use or sale. Please contact authorized Vishay personnel to obtain written terms and conditions regarding products designed for such applications.

Product names and markings noted herein may be trademarks of their respective owners.