

SKKT 72, SKKH 72, SKKT 72B



SEMIPACK® 1

Thyristor / Diode Modules

SKKT 72
SKKH 72
SKKT 72B

Features

- Heat transfer through aluminium oxide ceramic isolated metal baseplate
- Hard soldered joints for high reliability
- UL recognized, file no. E 63 532

Typical Applications

- DC motor control (e. g. for machine tools)
- AC motor soft starters
- Temperature control (e. g. for ovens, chemical processes)
- Professional light dimming (studios, theaters)

1) See the assembly instructions

V_{RSM} V	V_{RRM}, V_{DRM} V	$I_{TRMS} = 125$ A (maximum value for continuous operation) $I_{TAV} = 70$ A (sin. 180; $T_c = 85$ °C)		
900	800	SKKT 72/08E	SKKT 72B08E	SKKH 72/08E
1300	1200	SKKT 72/12E	SKKT 72B12E	SKKH 72/12E
1500	1400	SKKT 72/14E	SKKT 72B14E	SKKH 72/14E
1700	1600	SKKT 72/16E	SKKT 72B16E	SKKH 72/16E
1900	1800	SKKT 72/18E	SKKT 72B18E	SKKH 72/18E
2100	2000	SKKT 72/20EH4		SKKH 72/20EH4
2300	2200	SKKT 72/22EH4		SKKH 72/22EH4

Symbol	Conditions	Values	Units
I_{TAV}	sin. 180; $T_c = 85$ (100) °C;	70 (50)	A
I_D	P3/180; $T_a = 45$ °C; B2 / B6	62 / 75	A
	P3/180F; $T_a = 35$ °C; B2 / B6	115 / 145	A
I_{RMS}	P3/180F; $T_a = 35$ °C; W1 / W3	155 / 3 * 115	A
I_{TSM}	$T_{vj} = 25$ °C; 10 ms	1600	A
	$T_{vj} = 125$ °C; 10 ms	1450	A
i^2t	$T_{vj} = 25$ °C; 8,3 ... 10 ms	13000	A ² s
	$T_{vj} = 125$ °C; 8,3 ... 10 ms	10500	A ² s
V_T	$T_{vj} = 25$ °C; $I_T = 300$ A	max. 1,9	V
$V_{T(TO)}$	$T_{vj} = 125$ °C	max. 0,9	V
r_T	$T_{vj} = 125$ °C	max. 3,5	mΩ
I_{DD}, I_{RD}	for SKK .../20E; SKK .../22E	30	mA
I_{DD}, I_{RD}	$T_{vj} = 125$ °C; $V_{RD} = V_{RRM}$; $V_{DD} = V_{DRM}$	max. 20	mA
t_{gd}	$T_{vj} = 25$ °C; $I_G = 1$ A; $di_G/dt = 1$ A/μs	1	μs
t_{gr}	$V_D = 0,67 * V_{DRM}$	1	μs
$(di/dt)_{cr}$	$T_{vj} = 125$ °C	max. 150	A/μs
$(dv/dt)_{cr}$	$T_{vj} = 125$ °C	max. 1000	V/μs
t_q	$T_{vj} = 125$ °C	80	μs
I_H	$T_{vj} = 25$ °C; typ. / max.	150 / 250	mA
I_L	$T_{vj} = 25$ °C; $R_G = 33$ Ω; typ. / max.	300 / 600	mA
V_{GT}	$T_{vj} = 25$ °C; d.c.	min. 3	V
I_{GT}	$T_{vj} = 25$ °C; d.c.	min. 150	mA
V_{GD}	$T_{vj} = 125$ °C; d.c.	max. 0,25	V
I_{GD}	$T_{vj} = 125$ °C; d.c.	max. 6	mA
$R_{th(j-c)}$	cont.; per thyristor / per module	0,35 / 0,18	K/W
$R_{th(j-c)}$	sin. 180; per thyristor / per module	0,37 / 0,19	K/W
$R_{th(j-c)}$	rec. 120; per thyristor / per module	0,39 / 0,2	K/W
$R_{th(c-s)}$	per thyristor / per module	0,2 / 0,1	K/W
T_{vj}		- 40 ... + 125	°C
T_{stg}		- 40 ... + 125	°C
V_{isol}	a. c. 50 Hz; r.m.s.; 1 s / 1 min.	3600 / 3000	V~
V_{isol}	a. c. 50 Hz; r.m.s.; 1 s / 1 min. for SKK...H4	4800 / 4000	V~
M_s	to heatsink	5 ± 15 % ¹⁾	Nm
M_t	to terminals	3 ± 15 %	Nm
a		5 * 9,81	m/s ²
m	approx.	95	g
Case	SKKT	A 46	
	SKKT ...B	A 48	
	SKKH	A 47	

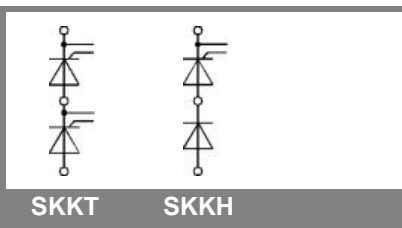

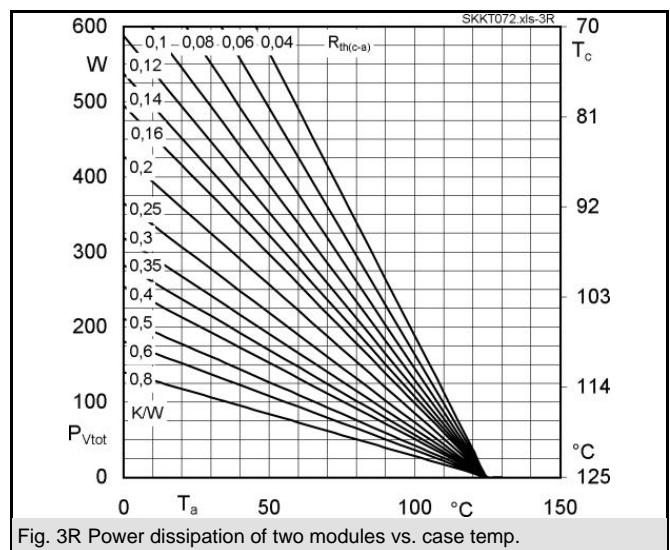
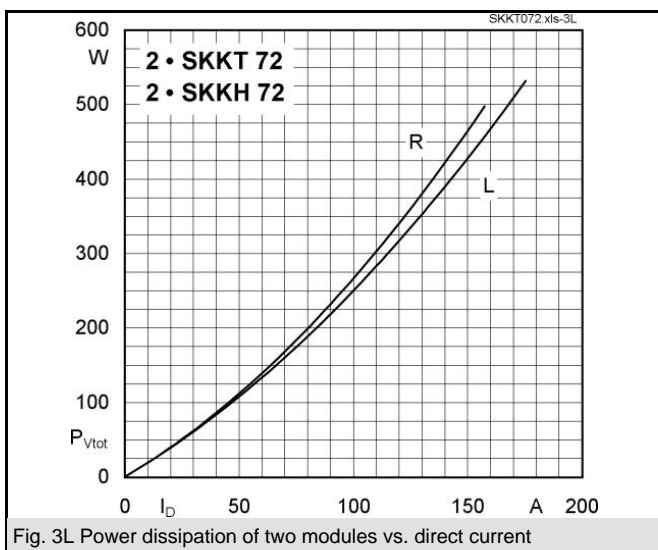
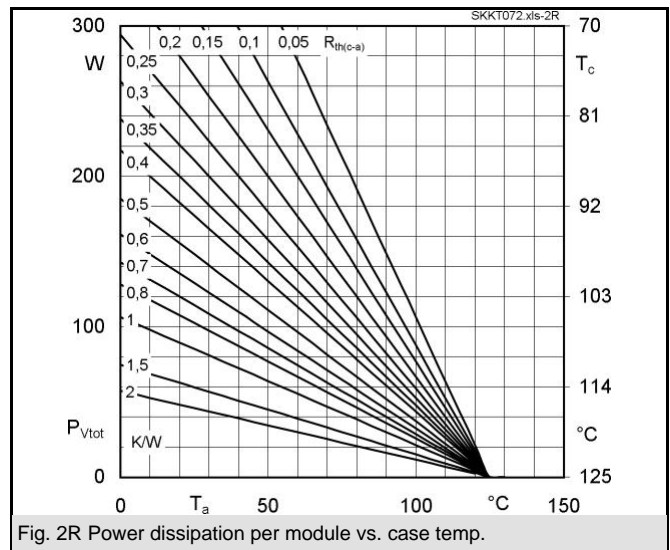
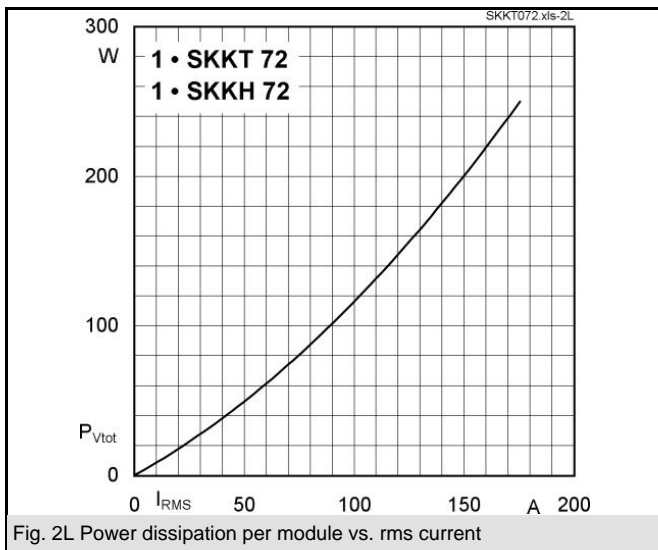
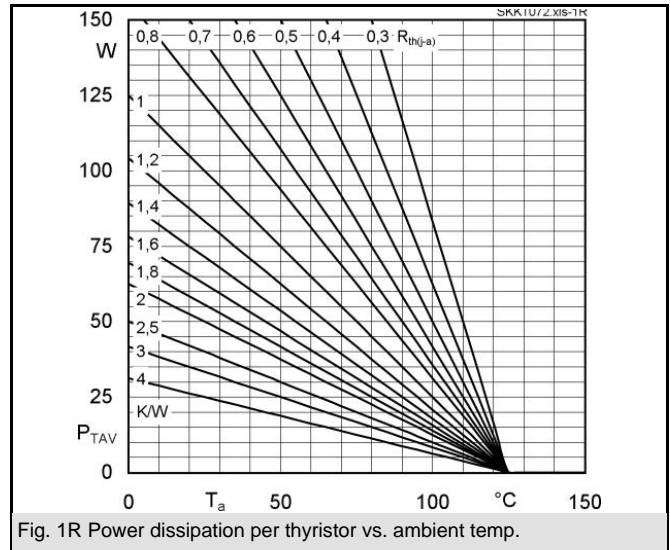
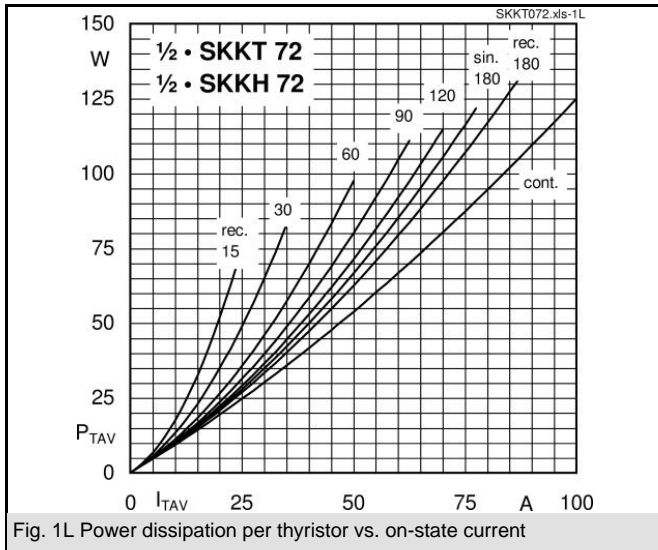

SKKT 72, SKKH 72, SKKT 72B

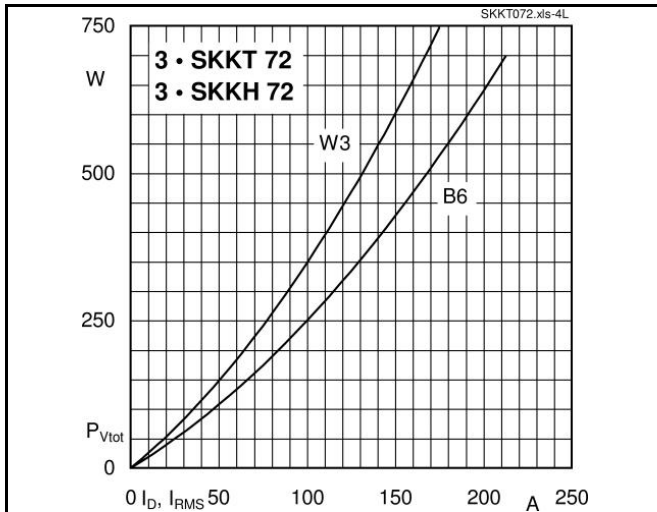

Fig. 4L Power dissipation of three modules vs. direct and rms current

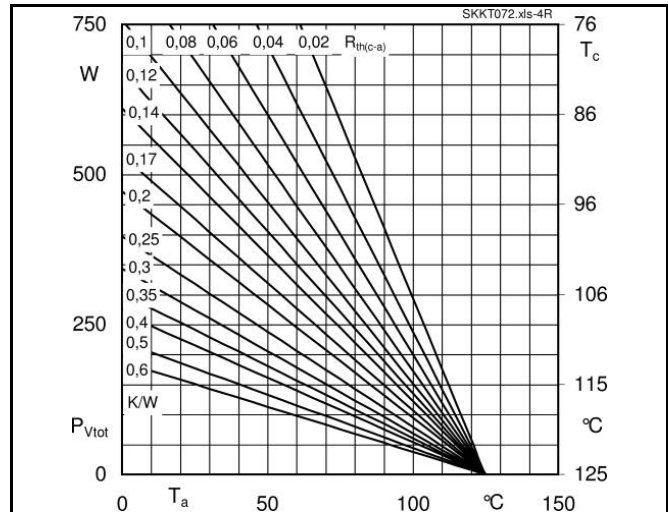

Fig. 4R Power dissipation of three modules vs. case temp.

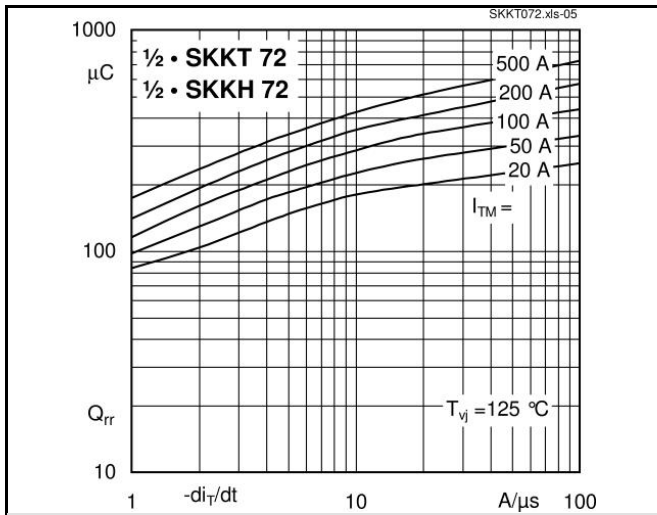

Fig. 5 Recovered charge vs. current decrease

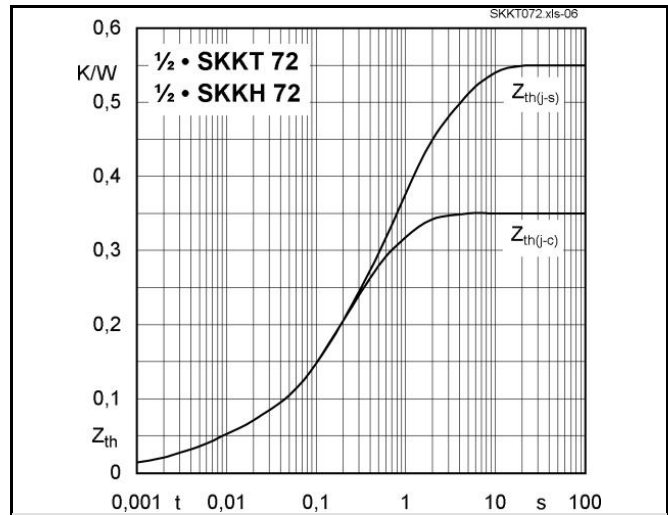

Fig. 6 Transient thermal impedance vs. time

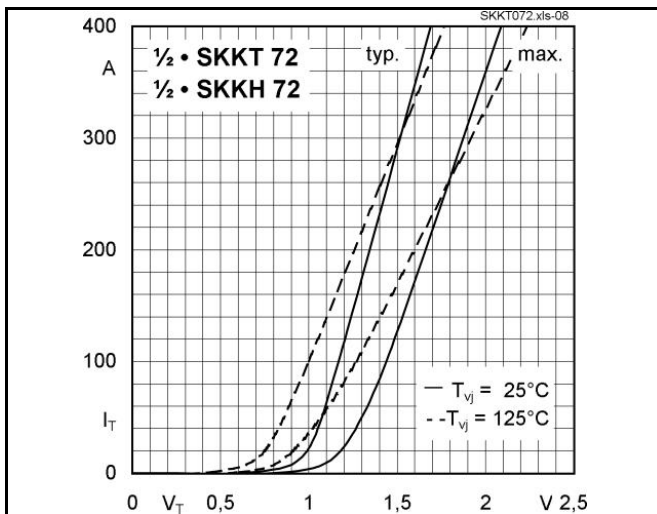

Fig. 7 On-state characteristics

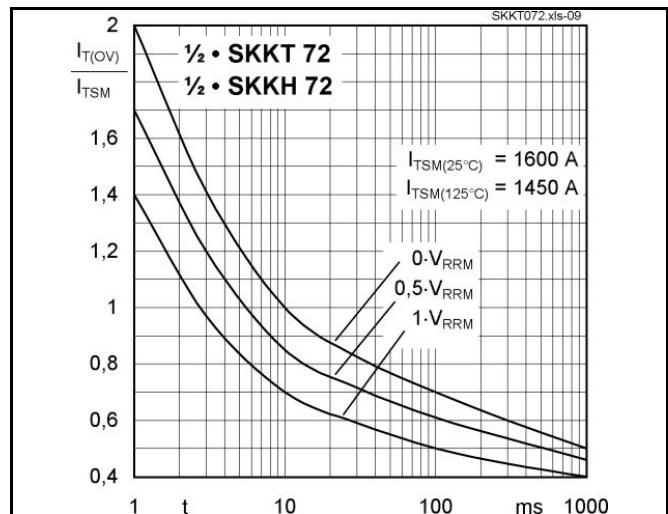
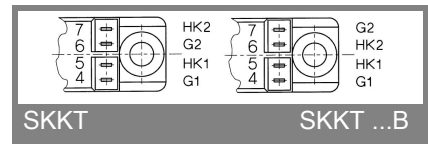
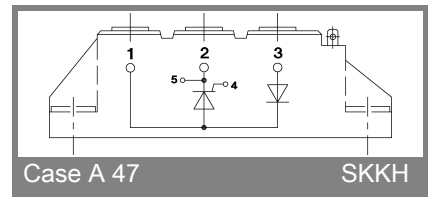
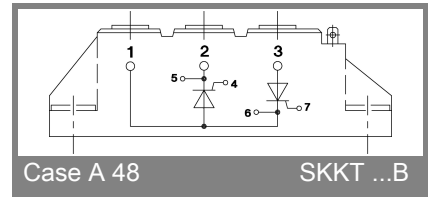
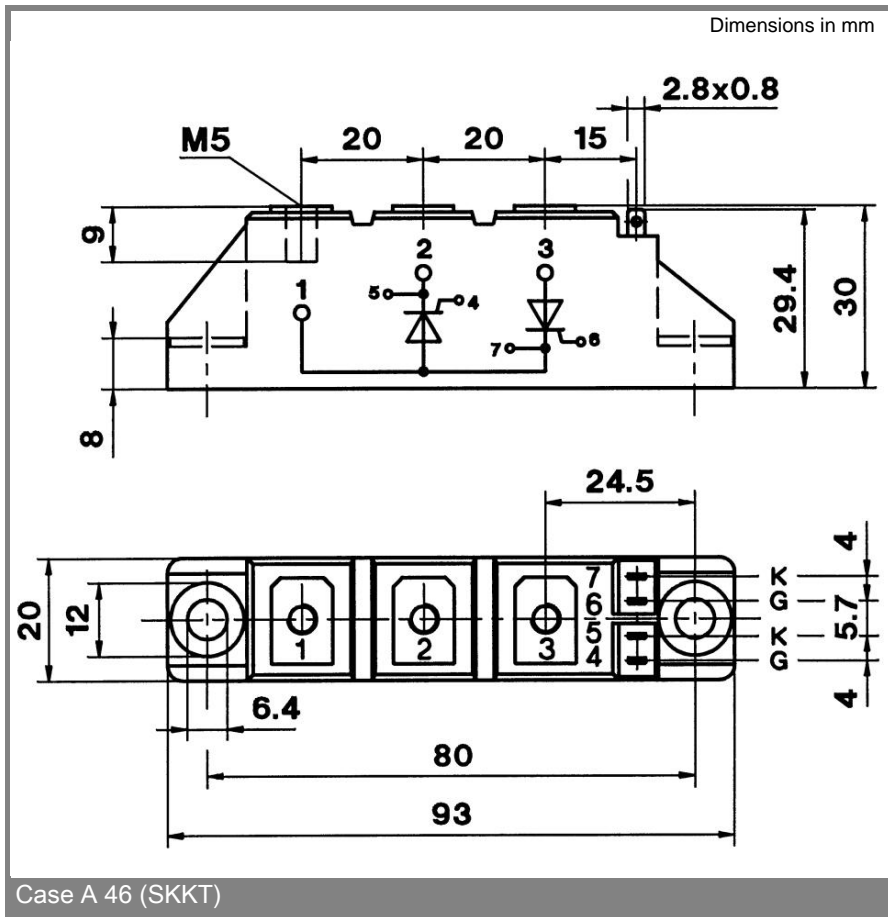
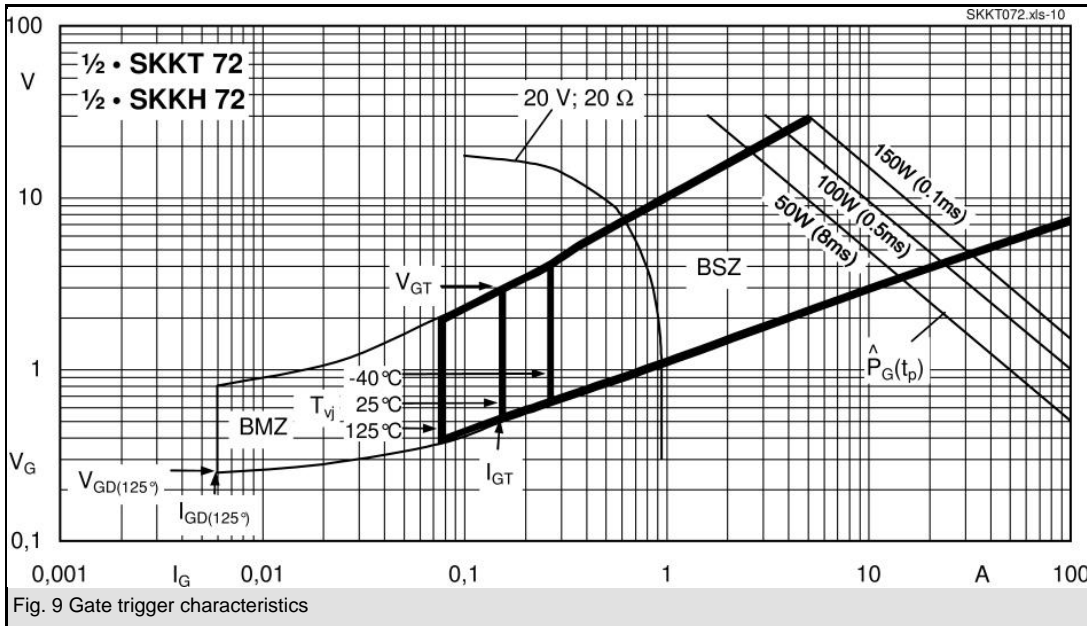

Fig. 8 Surge overload current vs. time



This technical information specifies semiconductor devices but promises no characteristics. No warranty or guarantee expressed or implied is made regarding delivery, performance or suitability.