

Application Note

DFG Directional Microphone

Background

DFG (Patent Pending) is a new directional microphone series based on the omni-directional FG series. The DFG front sound port is on the surface opposite the terminal pads – same as for the FG series. The rear sound port is composed of a plurality of slots along the diameter halfway along the side.

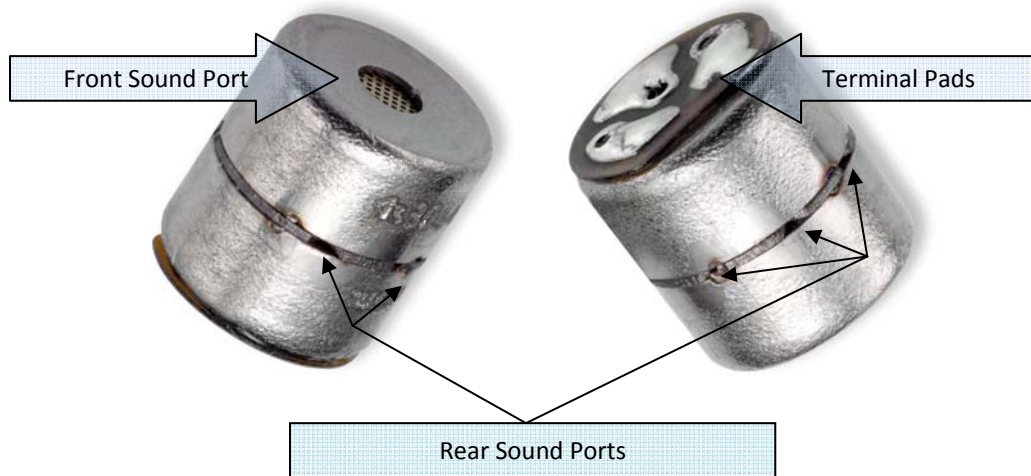

DFG is currently available in three models:

Model	Polar Pattern	Comment
DFG-30445-000	Cardioid	Internal delay \approx external delay
DFG-30852-000	Super-cardioid	Internal delay $<$ external delay
DFG-30851-000	Bi-directional	Internal delay \ll external delay

The directional performance listed above assumes the microphone is measured without a fixture or any additional housing or packaging. The external delay is the time for sound to travel from the front sound port to the rear sound ports. The internal delay depends on the construction of the microphone element. The three available models have differing internal delays.

Application Note

Construction

All three DFG models have the same external construction.

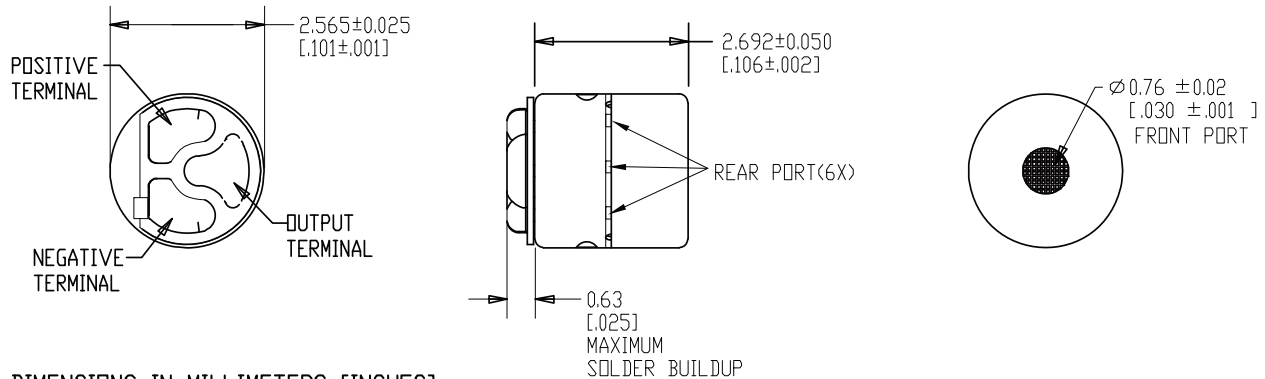

DIMENSIONS IN MILLIMETERS [INCHES]

The height of DFG is slightly greater than FG due to the added thickness of the center plate.

Performance

The directional performance of DFG is 100% tested in production. For practical reasons, the production test uses a holding fixture that makes contact with the microphone terminals. The fixture slightly increases the external delay for the measurement. The measurement is made in a semi-anechoic sound box to facilitate loading and unloading. The production test condition is described on Sheet 2.1 of the model specification. Sheet 2.2 of the model specification shows typical near field performance and directional performance in an anechoic chamber without a test fixture.

Typical near field response is measured with the microphone 6mm above the aperture of a B&K Type 4227 Mouth simulator. Typical far field and polar performance is measured 1m from the sound source in an anechoic chamber.

Typical Polar Performance is measured at 125Hz, 1kHz, 4kHz, and 10kHz.

Placing the microphone element in a housing will typically increase the distance between the front and rear port, which will make a cardioid pattern look more like a supercardioid pattern, and increase near field sensitivity.

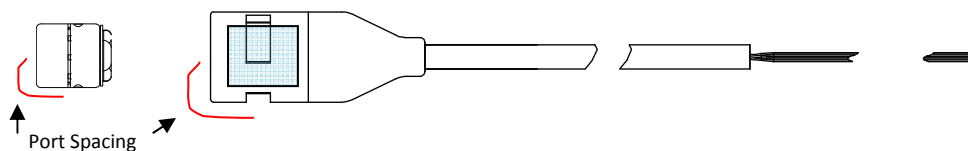

Application Note

DFG-30445-000 typical performance:

The 1kHz polar pattern for DFG-30445-000 measured at 1m in an anechoic chamber is approximately cardioid. The polar curves below represent actual data from a typical microphone (output amplitude in dB relative to 0 degrees).

TYPICAL FREE-FIELD POLAR PATTERN AT 125Hz:

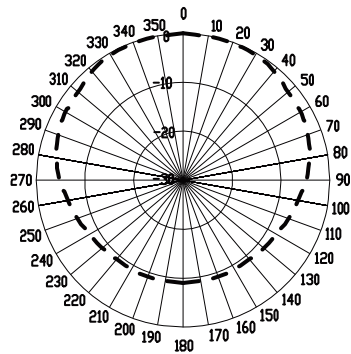

TYPICAL FREE-FIELD POLAR PATTERN AT 1KHz:

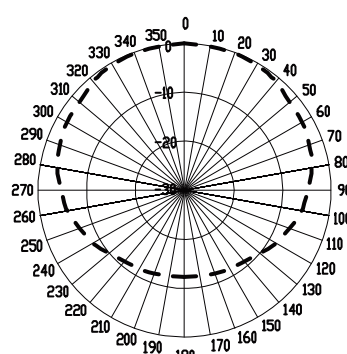

TYPICAL FREE-FIELD POLAR PATTERN AT 4KHz:

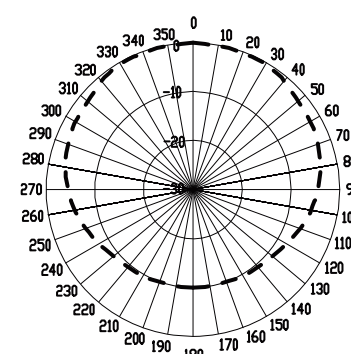

TYPICAL FREE-FIELD POLAR PATTERN AT 10KHz:

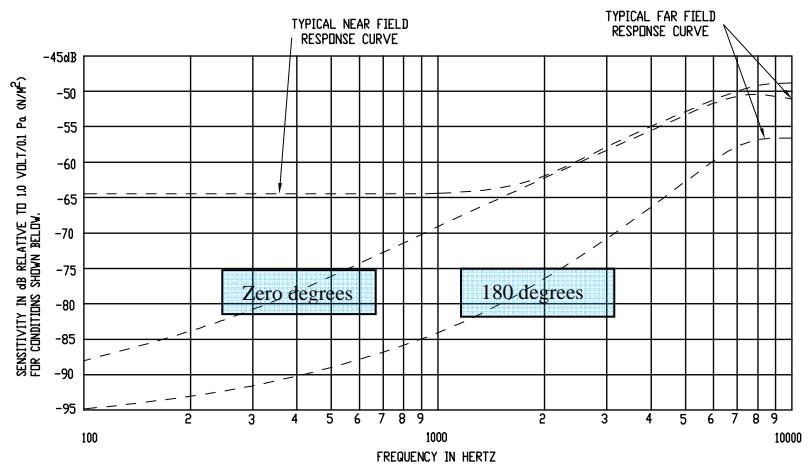
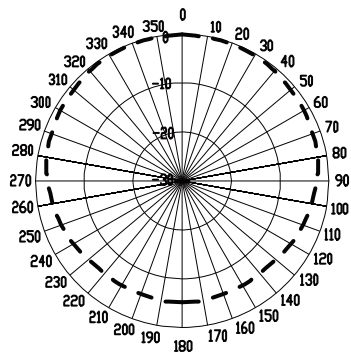

The typical frequency response curves are based on the average performance of several microphones. For a near field application such as a headset, the designer may wish to add a low-pass filter to the microphone output to flatten the rising response at high frequencies.

For measurement, the microphone was suspended on lead wires for the typical tests as shown.

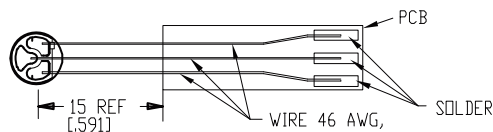

Application Note

DFG-30852-000 typical performance:

The 1kHz polar pattern for DFG-30852-000 measured at 1m in an anechoic chamber is approximately super-cardioid. The polar curves below represent actual data from a typical microphone (output amplitude in dB relative to 0 degrees).

TYPICAL FREE-FIELD POLAR PATTERN AT 125Hz:

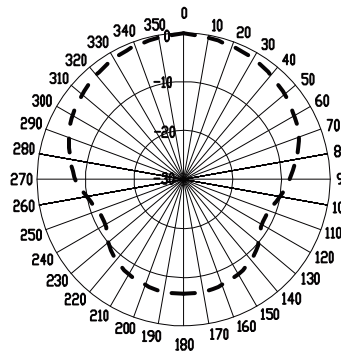

TYPICAL FREE-FIELD POLAR PATTERN AT 1KHz:

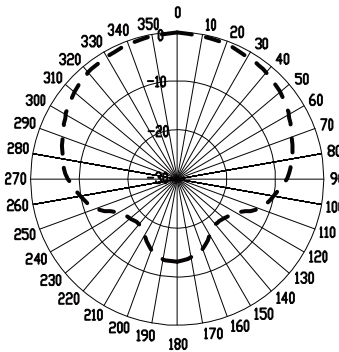

TYPICAL FREE-FIELD POLAR PATTERN AT 4KHz:

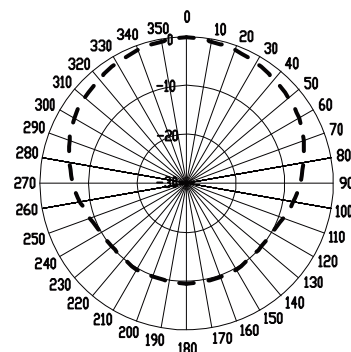

TYPICAL FREE-FIELD POLAR PATTERN AT 10KHz:

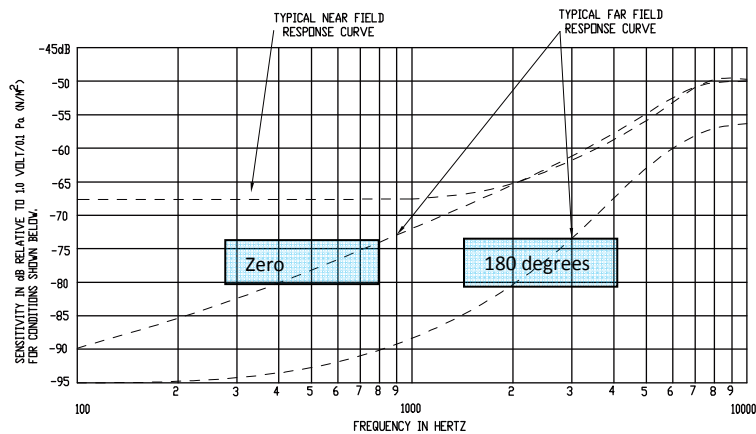
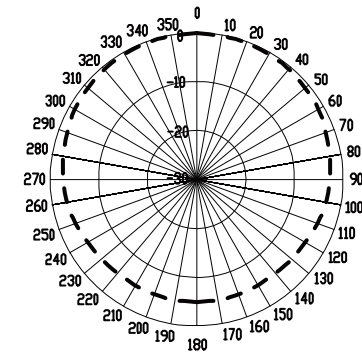

The typical frequency response curves are based on the average performance of several microphones. For a near field application such as a headset, the designer may wish to add a low-pass filter to the microphone output to flatten the rising response at high frequencies.

The microphone was suspended on lead wires for the typical tests as shown.

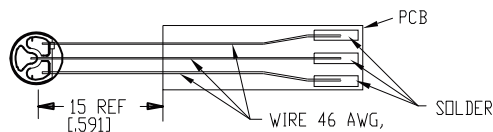

Application Note

DFG-30851-000 typical performance:

The 1kHz polar pattern for DFG-30851-000 measured at 1m in an anechoic chamber is approximately bi-directional. Bi-directional microphones are more sensitive to position relative to the mouth compared to uni-directional microphones, but noise-canceling performance is better. The polar curves below represent actual data from a typical microphone (output amplitude in dB relative to 0 degrees).

TYPICAL FREE-FIELD POLAR PATTERN AT 125Hz:

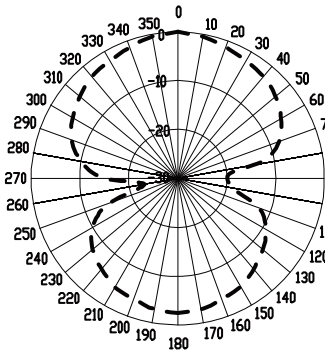

TYPICAL FREE-FIELD POLAR PATTERN AT 1KHz:

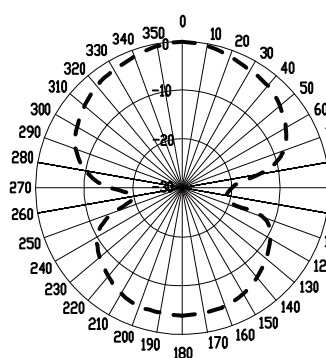

TYPICAL FREE-FIELD POLAR PATTERN AT 4KHz:

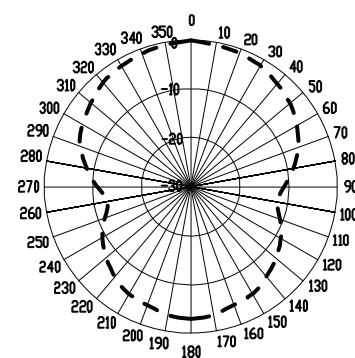

TYPICAL FREE-FIELD POLAR PATTERN AT 10KHz:

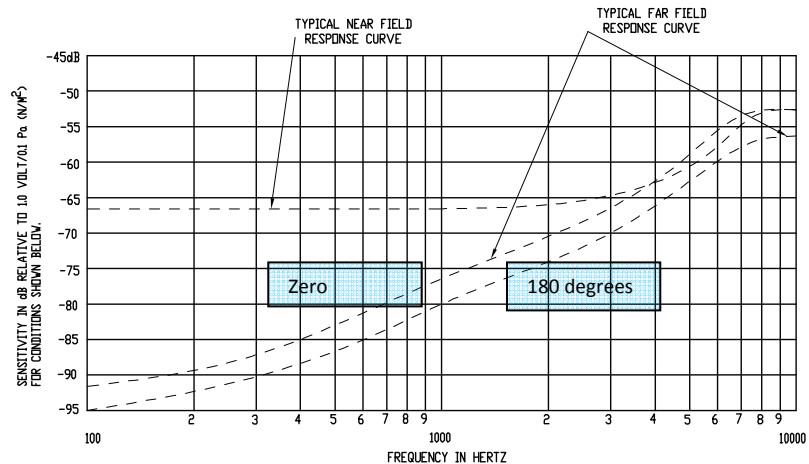
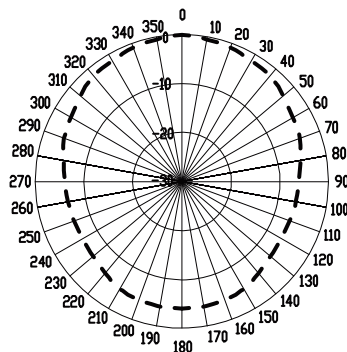

The typical frequency response curves are based on the average performance of several microphones. For a near field application such as a headset, the designer may wish to add a low-pass filter to the microphone output to flatten the rising response at high frequencies.

The microphone was suspended on lead wires for the typical tests as shown.

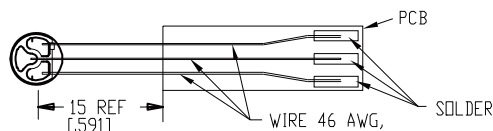

Application Note

Applications

DFG microphone elements were designed for use in low-profile headsets and head-worn microphones. When combined with a boom of very small diameter, the microphone becomes near invisible. To demonstrate the form factor and performance of DFG, KA offers reference designs for U Series micro-booms and TC Series headsets that include the U Series micro-booms.

DFG elements may also be used as a probe microphone to listen to close to sound sources in tight quarters, or as a low-profile general-purpose directional microphone that operates at a greater distance from the sound source.

U Series Micro-Booms

U Series Micro-Booms demonstrate the performance and size advantages of DFG.



U Series boom



U Series boom with windscreen

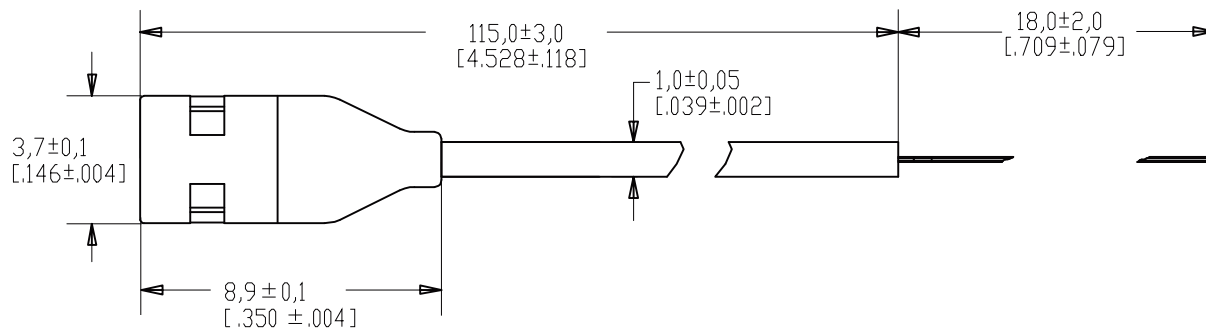

U Series boom dimensions in mm (inches)

Application Note

U Series Micro-Booms (available reference designs)

Model Number	Ingress Protection Rating	Microphone Element	Directivity	Termination
FB-MU-30749-000	IP54	DFG-30445-000	Super-cardioid	2-wire
FB-MU-31024-000	IP54	DFG-30851-000	Noise Canceling (Bi-directional)	3-wire
FB-MU-31025-000	IP67	VFG-30747-000	Omni-directional	3-wire

Termination Detail

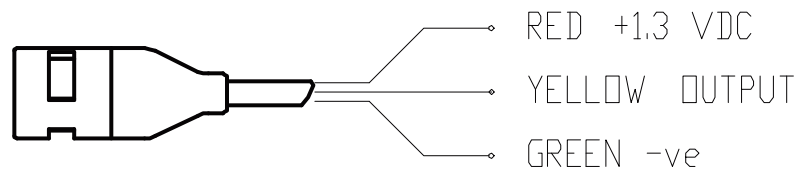
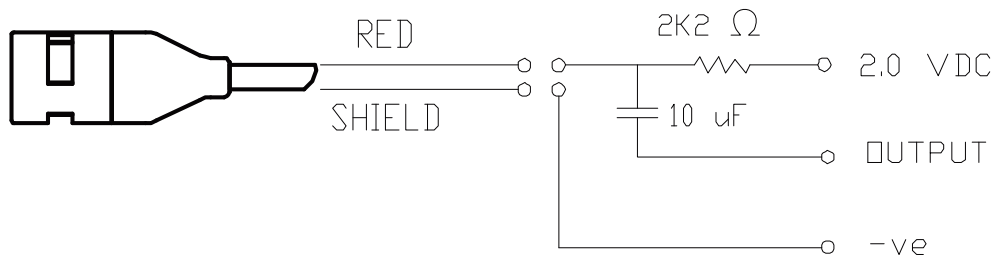

7 of 9

www.knowlesacoustics.com

AMERICAS:
Knowles Acoustics
1151 Maplewood Drive
Itasca, IL 60143
U.S.A.
Phone: 630-250-5930
Fax: 630-250-5932

EUROPE:
Knowles Acoustics
York Road, Burgess Hill
West Sussex, RH15 9TT
England
Phone: +44-1444-235432
Fax: +44-1444-872772

JAPAN:
Knowles Electronics Japan, KK
2-2-16, Sanganjaya,
Setagaya-ku, Tokyo
154-0024 JAPAN
Tel. +81-3-5779-8503
Fax: +81-3-5779-8523

ASIA:
Knowles Acoustics
5F, No. 129, Lane 235, Bauchiau Rd.
Shindian City, Taipei 231, Taiwan
Republic of China
Phone: 886-2-8919-1799
Fax: 886-2-8919-1798

Application Note

T Series Headsets with U Series Micro-Booms

T Series Headsets with U Series Micro-Booms demonstrate the performance and size advantages of DFG and Knowles balanced armature receivers.



Head-worn micro-boom

Models

TC-7144-000

TC-7148-000



Micro-boom headset (RIE type)

Models

TC-7154-000

TC-7154-B36



Micro-boom headset

Models

TC-7143-000

TC-7143-B36

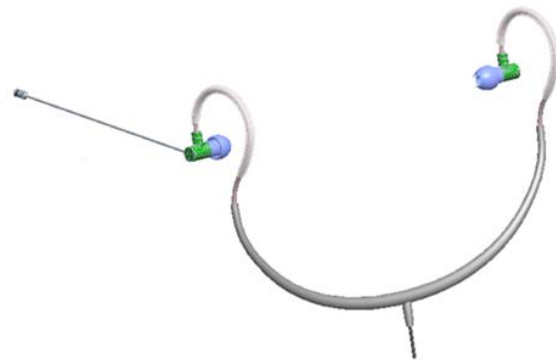

Micro-boom headset (stereo)

Model

TC-7146-000

Application Note

TC Series Microphones and Headsets with U Series Micro-Booms (available reference designs)

Model	Microphone Type	Boom Length	Microphone	Receiver	Stereo/Mono
TC-7143-000	Noise Canceling	115mm	DFG-30851-000	ED-23147-000	Mono
TC-7143-B36	Super Cardioid	90mm	DFG-30445-000	ED-23147-000	Mono
TC-7144-000	Noise Canceling	115mm	DFG-30851-000	N/A	N/A
TC-7146-000	Super Cardioid	115mm	DFG-30445-000	2 X ED-23147-000	Stereo
TC-7148-000	Super Cardioid	90mm	DFG-30445-000	N/A	N/A
TC-7154-000	Super Cardioid	115mm	DFG-30851-000	SR6438NWS-000	Mono
TC-7154-B36	Super Cardioid	90mm	DFG-30445-000	SR6438NWS-000	Mono

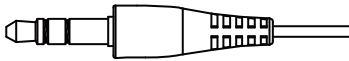

Termination Detail

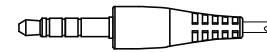

- Cable length: 1.4m
- Headworn microphone connector: 3.5mm stereo
- Headset connector: 2.5mm 4-position

Pin-outs	Headworn Microphone	Mono Headset	Stereo Headset
Tip	Mic+	Not used	Receiver – left
1 st ring	Mic+	Receiver	Receiver – right
2 nd ring	N/A	Mic	Mic
Sleeve	Mic-	Common	Common

9 of 9

www.knowlesacoustics.com

AMERICAS:
Knowles Acoustics
1151 Maplewood Drive
Itasca, IL 60143
U.S.A.
Phone: 630-250-5930
Fax: 630-250-5932

EUROPE:
Knowles Acoustics
York Road, Burgess Hill
West Sussex, RH15 9TT
England
Phone: +44-1444-235432
Fax: +44-1444-872772

JAPAN:
Knowles Electronics Japan, KK
2-2-16, Sanganjaya,
Setagaya-ku, Tokyo
154-0024 JAPAN
Tel. +81-3-5779-8503
Fax: +81-3-5779-8523

ASIA:
Knowles Acoustics
5F, No. 129, Lane 235, Bauchiau Rd.
Shindian City, Taipei 231, Taiwan
Republic of China
Phone: 886-2-8919-1799
Fax: 886-2-8919-1798