

HEAVY-DUTY SNAP ACTION

GP Series

Features

- Ultra-small travel differential
- Mechanical life tested to 1 million cycles
- Current switching to 20 amps
- Wide variety of actuators
- Screw or solder terminals standard
- Low operating forces available

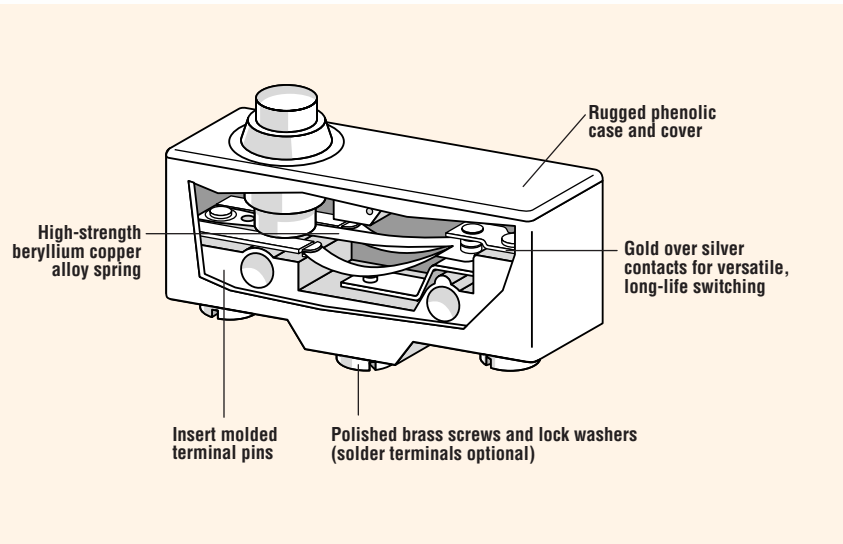

Electrical Ratings

Switch Series	UL1054 Rating
GP*B	20A, 1HP, 125VAC; 20A, 2HP, 250VAC; .5A, 125VDC; .25A, 250VDC
GP*C	15A, 1/8HP, 125VAC; 15A, 1/4HP, 250VAC; .5A, 125VDC; .25A, 250VDC

Specifications

Dielectric Strength:	1000VAC 50/60Hz for 1 minute
Insulation Resistance:	100M ohms min at 500VDC
Initial Contact Resistance:	15m ohms max
Temperature Range:	-20° to +85°C

Materials



Case:	Phenolic
Cover:	Phenolic
Spring:	Beryllium Copper Alloy
Contacts:	Silver Alloy
Terminals:	Brass Screw Terminals; Copper Alloy Solder Terminals
Lever Actuator:	Stainless Steel

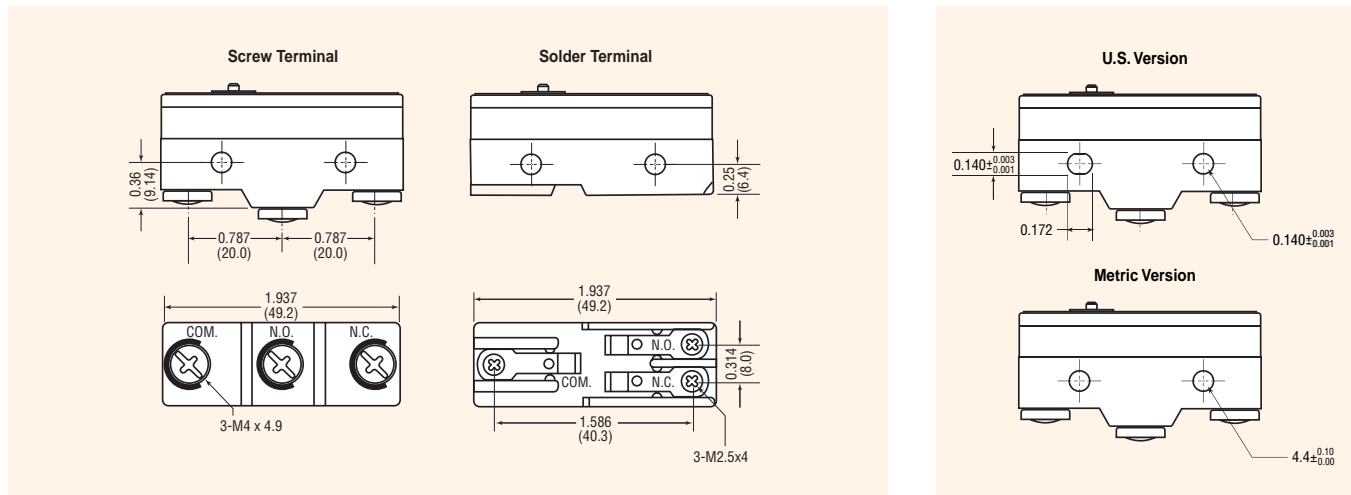

Terminal Types inches (mm)

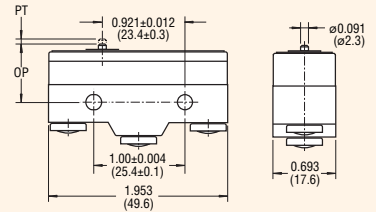
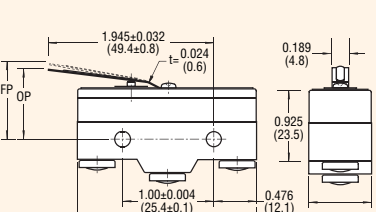
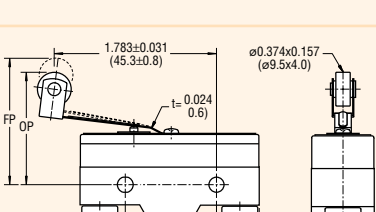
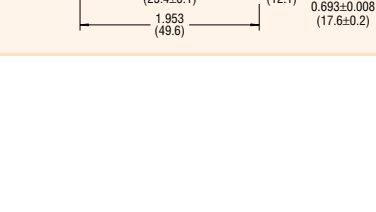

Standard Part Numbers and Descriptions

Dimensions inches (mm)	Part Number	Maximum Operating Force (oz.)	Minimum Release Force (oz.)	Maximum Pre-Travel inches (mm)	Operating Point Min./Max. inches (mm)	Minimum Over-Travel inches (mm)	Max. Movement Differential inches (mm)	Mounting Hole†	Terminal Type*
	GPTCNA11	12.3	4.0	0.016 (0.41)	0.610/0.642 (15.49/16.31)	0.005 (0.13)	0.002 (0.05)	U.S.	Screw
	GPTBNA11	22.2	7.1	0.051 (1.30)	0.625/0.657 (15.90/16.70)	0.009 (0.25)	0.008 (0.20)	U.S.	Screw
	GPTCLR11	10.5	1.7	0.157 (4.00)	0.654/0.717 (16.60/18.20)	0.062 (1.60)	0.051 (1.30)	U.S.	Screw
	GPTBLR11	9.0	0.98	0.157 (4.00)	0.654/0.717 (16.60/18.20)	0.062 (1.60)	0.067 (1.70)	U.S.	Screw
	GPTCRR11	10.6	1.8	0.157 (4.00)	1.094/1.157 (27.80/29.40)	0.062 (1.60)	0.051 (1.30)	U.S.	Screw
	GPTBRR11	9.0	0.98	0.157 (4.00)	1.094/1.157 (27.80/29.40)	0.062 (1.60)	0.067 (1.70)	U.S.	Screw

NOTE: GP Series switches are available with screw or solder terminals in U.S. or metric sizes.
 *For solder terminals, replace the "T" in the third position of the part number with an "S" (e.g., GPTCND11 becomes GPTSCND11).
 †For metric mounting, replace the "1" in the seventh position with a "0" (e.g., GPTCND11 becomes GPTCND01).

Standard Part Numbers and Descriptions

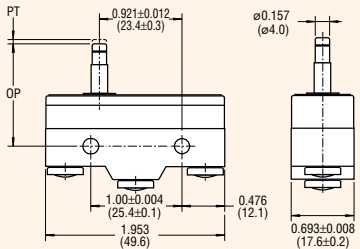
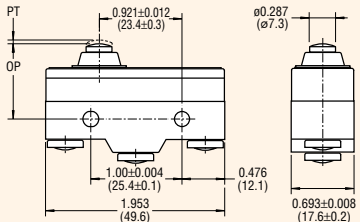
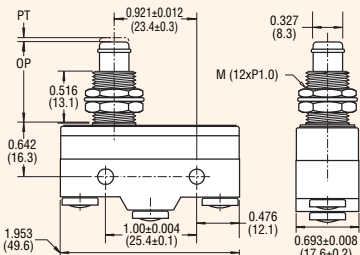
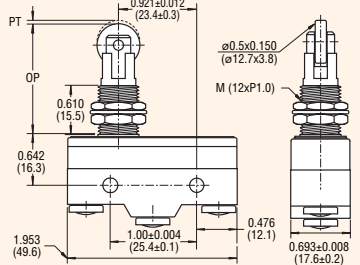
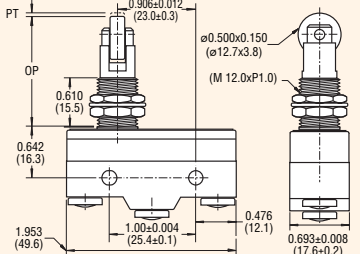
Dimensions inches (mm)	Part Number	Maximum Operating Force (oz.)	Minimum Release Force (oz.)	Maximum Pre-Travel inches (mm)	Operating Point Min./Max. inches (mm)	Minimum Over-Travel inches (mm)	Max. Movement Differential inches (mm)	Mounting Hole†	Terminal Type*
	GPTCND11	12.3	4.0	0.016 (0.41)	1.09/1.13 (27.70/28.70)	0.063 (1.60)	0.002 (0.05)	U.S.	Screw
	GPTBND11	22.9	7.1	0.028 (0.70)	1.091/1.130 (27.70/28.70)	0.062 (1.60)	0.008 (0.20)	U.S.	Screw
	GPTCNC11	12.3	4.0	0.106 (0.40)	0.826/0.866 (21.00/22.00)	0.062 (1.60)	0.002 (0.05)	U.S.	Screw
	GPTBNC11	22.9	7.1	0.028 (0.70)	0.826/0.866 (21.00/22.00)	0.062 (1.60)	0.008 (0.20)	U.S.	Screw
	GPTCNH11	12.3	4.0	0.016 (0.41)	0.826/0.890 (20.98/22.60)	0.217 (5.51)	0.002 (0.05)	U.S.	Screw
	GPTBNH11	22.9	7.1	0.028 (0.70)	0.826/0.890 (21.00/22.60)	0.217 (5.50)	0.008 (0.20)	U.S.	Screw
	GPTCRH11	12.3	4.0	0.016 (0.40)	1.268/1.362 (32.20/34.60)	0.140 (3.58)	0.002 (0.05)	U.S.	Screw
	GPTBRH11	22.9	7.1	0.028 (0.70)	1.268/1.362 (32.20/34.60)	0.140 (3.56)	0.008 (0.20)	U.S.	Screw
	GPTCRH12	12.3	4.0	0.160 (0.40)	1.268/1.362 (32.20/34.60)	0.140 (3.56)	0.002 (0.05)	U.S.	Screw
	GPTBRH12	22.9	7.1	0.028 (0.70)	1.268/1.362 (32.20/34.60)	0.140 (3.56)	0.008 (0.20)	U.S.	Screw

NOTE: GP Series switches are available with screw or solder terminals in U.S. or metric sizes.

*For solder terminals, replace the "T" in the third position of the part number with an "S" (e.g., GPTCND11 becomes GPTSCND11).

†For metric mounting, replace the "1" in the seventh position with a "0" (e.g., GPTCND11 becomes GPTCND01).

Standard Part Numbers and Descriptions

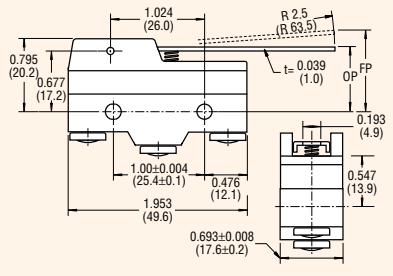
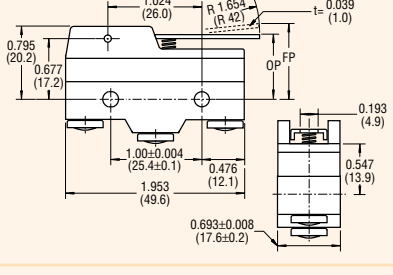
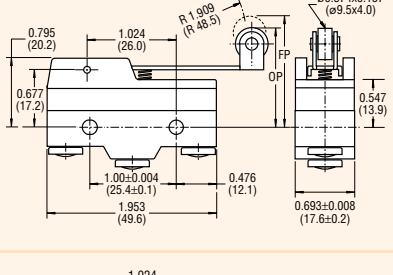
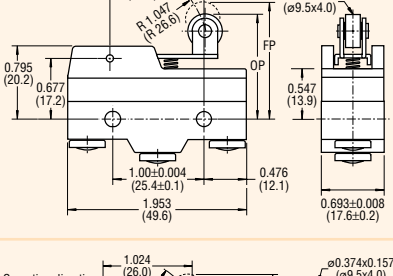
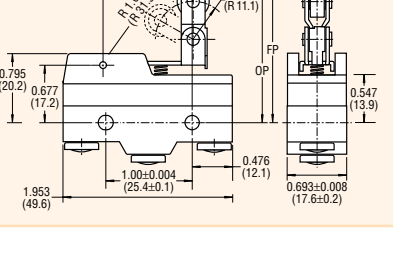
Dimensions inches (mm)	Part Number	Maximum Operating Force (oz.)	Minimum Release Force (oz.)	Maximum Pre-Travel inches (mm)	Operating Point Min./Max. inches (mm)	Minimum Over-Travel inches (mm)	Max. Movement Differential inches (mm)	Mounting Hole [†]	Terminal Type*
	GPTCLS11	2.4	0.50	0.394 (10.00)	0.716/0.780 (18.20/19.80)	0.220 (5.61)	0.050 (1.27)	U.S.	Screw
	GPTBLS11	2.8	0.50	0.394 (10.00)	0.716/0.780 (18.20/19.80)	0.220 (5.61)	0.007 (0.20)	U.S.	Screw
	GPTCLS12	3.1	0.70	0.315 (8.00)	0.716/0.780 (18.20/19.80)	0.125 (3.20)	0.040 (1.02)	U.S.	Screw
	GPTBLS12	4.2	1.4	0.315 (8.00)	0.716/0.780 (18.20/19.80)	0.125 (3.20)	0.040 (1.02)	U.S.	Screw
	GPTCRS11	3.5	0.80	0.280 (7.10)	1.157/1.220 (29.40/31.00)	0.158 (4.00)	0.040 (1.02)	U.S.	Screw
	GPTBRS11	4.2	0.80	0.280 (7.10)	1.157/1.220 (29.40/31.00)	0.158 (4.00)	0.040 (1.02)	U.S.	Screw
	GPTCRM11	5.6	1.4	0.106 (2.70)	1.173/1.205 (29.80/30.60)	0.094 (2.40)	0.020 (0.50)	U.S.	Screw
	GPTBRM11	6.4	1.5	0.106 (2.70)	1.173/1.205 (29.80/30.60)	0.094 (2.40)	0.020 (0.50)	U.S.	Screw
	GPTCRG11	5.6	1.4	0.106 (2.70)	1.594/1.658 (40.50/42.10)	0.094 (2.40)	0.020 (0.50)	U.S.	Screw
	GPTBRG11	6.3	1.4	0.106 (2.70)	1.594/1.658 (40.50/42.10)	0.094 (2.40)	0.020 (0.50)	U.S.	Screw

NOTE: GP Series switches are available with screw or solder terminals in U.S. or metric sizes.
 *For solder terminals, replace the "T" in the third position of the part number with an "S" (e.g., GPTCND11 becomes GPTSCND11).
 †For metric mounting, replace the "1" in the seventh position with a "0" (e.g., GPTCND11 becomes GPTCND01).