

# DS90LV012A/DS90LT012A

## 3V LVDS Single CMOS Differential Line Receiver

### General Description

The DS90LV012A and DS90LT012A are single CMOS differential line receivers designed for applications requiring ultra low power dissipation, low noise, and high data rates. The devices are designed to support data rates in excess of 400 Mbps (200 MHz) utilizing Low Voltage Differential Swing (LVDS) technology

The DS90LV012A and DS90LT012A accept low voltage (350 mV typical) differential input signals and translates them to 3V CMOS output levels. The receivers also support open, shorted, and terminated (100Ω) input fail-safe. The receiver output will be HIGH for all fail-safe conditions. The DS90LV012A has a pinout designed for easy PCB layout. The DS90LT012A includes an input line termination resistor for point-to-point applications.

The DS90LV012A and DS90LT012A, and companion LVDS line driver provide a new alternative to high power PECL/ECL devices for high speed interface applications.

### Features

- Compatible with ANSI TIA/EIA-644-A Standard
- >400 Mbps (200 MHz) switching rates
- 100 ps differential skew (typical)
- 3.5 ns maximum propagation delay
- Integrated line termination resistor (102Ω typical)
- Single 3.3V power supply design (2.7V to 3.6V range)
- Power down high impedance on LVDS inputs
- Accepts small swing (350 mV typical) differential signal levels
- LVDS receiver inputs accept LVDS/BLVDS/LVPECL inputs
- Supports open, short and terminated input fail-safe
- Pinout simplifies PCB layout
- Low Power Dissipation (10mW typical@ 3.3V static)
- SOT-23 5-lead package
- Leadless LLP-8 package (3x3 mm body size)
- Electrically similar to the DS90LV018A
- Fabricated with advanced CMOS process technology
- Industrial temperature operating range (-40°C to +85°C)

### Connection Diagrams

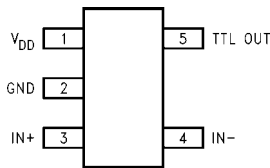

20015026

(Top View)

Order Number DS90LV012ATMF, DS90LT012ATMF  
See NS Package Number MF05A

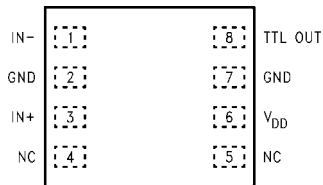

20015027

(Top View)

Order Number DS90LV012ATLD, DS90LT012ATLD  
See NS Package Number LDA08A

### Functional Diagram

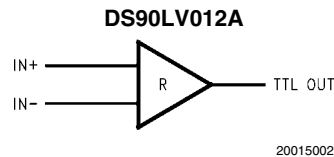

20015002

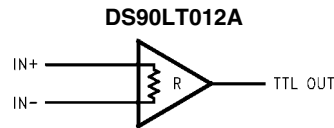

20015025

### Truth Table

INPUTS	OUTPUT
[IN+] - [IN-]	TTL OUT
$V_{ID} \geq 0V$	H
$V_{ID} \leq -0.1V$	L
Full Fail-safe OPEN/SHORT or Terminated	H

**Absolute Maximum Ratings** (Note 1)

If Military/Aerospace specified devices are required, please contact the National Semiconductor Sales Office/ Distributors for availability and specifications.

Supply Voltage ( $V_{DD}$ )	-0.3V to +4V
Input Voltage ( $IN+$ , $IN-$ )	-0.3V to +3.9V
Output Voltage (TTL OUT)	-0.3V to ( $V_{DD} + 0.3V$ )
Output Short Circuit Current	-100mA
Maximum Package Power Dissipation @ +25°C	
LDA Package	2.26 W
Derate LDA Package	18.1 mW/°C above +25°C
Thermal resistance ( $\theta_{JA}$ )	55.3°C/W
MF Package	902mW
Derate MF Package	7.22 mW/°C above +25°C

Thermal resistance ( $\theta_{JA}$ )	138.5°C/W
Storage Temperature Range	-65°C to +150°C
Lead Temperature Range Soldering (4 sec.)	+260°C
Maximum Junction Temperature	+150°C
ESD Ratings (Note 4)	

**Recommended Operating Conditions**

	Min	Typ	Max	Units
Supply Voltage ( $V_{DD}$ )	+2.7	+3.3	+3.6	V
Operating Free Air Temperature ( $T_A$ )	-40	25	+85	°C

**Electrical Characteristics**

Over Supply Voltage and Operating Temperature ranges, unless otherwise specified. (Notes 2, 3)

Symbol	Parameter	Conditions	Pin	Min	Typ	Max	Units
$V_{TH}$	Differential Input High Threshold	$V_{CM}$ dependant on $V_{DD}$ (Note 11)	$IN+$ , $IN-$		-30	0	mV
$V_{TL}$	Differential Input Low Threshold			-100	-30		mV
$V_{CM}$	Common-Mode Voltage	$V_{DD} = 2.7V$ , $V_{ID} = 100mV$		0.05		2.35	V
		$V_{DD} = 3.0V$ to $3.6V$ , $V_{ID} = 100mV$		0.05		$V_{DD} - 0.3V$	V
$I_{IN}$	Input Current (DS90LV012A)	$V_{IN} = +2.8V$	$V_{DD} = 3.6V$ or $0V$	-10	$\pm 1$	+10	$\mu A$
		$V_{IN} = 0V$		-10	$\pm 1$	+10	$\mu A$
		$V_{IN} = +3.6V$		$V_{DD} = 0V$	-20		+20
$\Delta I_{IN}$	Change in Magnitude of $I_{IN}$	$V_{IN} = +2.8V$	$V_{DD} = 3.6V$ or $0V$		4		$\mu A$
		$V_{IN} = 0V$			4		$\mu A$
		$V_{IN} = +3.6V$		$V_{DD} = 0V$		4	
$I_{IND}$	Differential Input Current (DS90LT012A)	$V_{IN+} = +0.4V$ , $V_{IN-} = +0V$		3	3.9	4.4	mA
		$V_{IN+} = +2.4V$ , $V_{IN-} = +2.0V$					
$R_T$	Integrated Termination Resistor (DS90LT012A)				102		$\Omega$
$C_{IN}$	Input Capacitance	$IN+ = IN- = GND$			3		pF
$V_{OH}$	Output High Voltage	$I_{OH} = -0.4 mA$ , $V_{ID} = +200 mV$	TTL OUT	2.4	3.1		V
		$I_{OH} = -0.4 mA$ , Inputs terminated		2.4	3.1		V
		$I_{OH} = -0.4 mA$ , Inputs shorted		2.4	3.1		V
$V_{OL}$	Output Low Voltage	$I_{OL} = 2 mA$ , $V_{ID} = -200 mV$			0.3	0.5	V
$I_{OS}$	Output Short Circuit Current	$V_{OUT} = 0V$ (Note 5)		-15	-50	-100	mA
$V_{CL}$	Input Clamp Voltage	$I_{CL} = -18 mA$		-1.5	-0.7		V
$I_{DD}$	No Load Supply Current	Inputs Open	$V_{DD}$		5.4	9	mA

## Switching Characteristics

Over Supply Voltage and Operating Temperature ranges, unless otherwise specified. (Notes 6, 7)

Symbol	Parameter	Conditions	Min	Typ	Max	Units
$t_{PHLD}$	Differential Propagation Delay High to Low	$C_L = 15 \text{ pF}$ $V_{ID} = 200 \text{ mV}$ (Figure 1 and Figure 2)	1.0	1.8	3.5	ns
$t_{PLHD}$	Differential Propagation Delay Low to High		1.0	1.7	3.5	ns
$t_{SKD1}$	Differential Pulse Skew $ t_{PHLD} - t_{PLHD} $ (Note 8)		0	100	400	ps
$t_{SKD3}$	Differential Part to Part Skew (Note 9)		0	0.3	1.0	ns
$t_{SKD4}$	Differential Part to Part Skew (Note 10)		0	0.4	1.5	ns
$t_{TLH}$	Rise Time			350	800	ps
$t_{THL}$	Fall Time			175	800	ps
$f_{MAX}$	Maximum Operating Frequency (Note 12)			200	250	

**Note 1:** "Absolute Maximum Ratings" are those values beyond which the safety of the device cannot be guaranteed. They are not meant to imply that the devices should be operated at these limits. The table of "Electrical Characteristics" specifies conditions of device operation.

**Note 2:** Current into device pins is defined as positive. Current out of device pins is defined as negative. All voltages are referenced to ground unless otherwise specified (such as  $V_{ID}$ ).

**Note 3:** All typicals are given for:  $V_{DD} = +3.3\text{V}$  and  $T_A = +25^\circ\text{C}$ .

**Note 4:** ESD Ratings:

DS90LV012A:

- HBM (1.5 k $\Omega$ , 100 pF)  $\geq 2\text{kV}$
- EIAJ (0 $\Omega$ , 200 pF)  $\geq 900\text{V}$
- CDM  $\geq 2000\text{V}$
- IEC direct (330 $\Omega$ , 150 pF)  $\geq 5\text{kV}$

DS90LT012A:

- HBM (1.5 k $\Omega$ , 100 pF)  $\geq 2\text{kV}$
- EIAJ (0 $\Omega$ , 200 pF)  $\geq 700\text{V}$
- CDM  $\geq 2000\text{V}$
- IEC direct (330 $\Omega$ , 150 pF)  $\geq 7\text{kV}$

**Note 5:** Output short circuit current ( $I_{OS}$ ) is specified as magnitude only, minus sign indicates direction only. Only one output should be shorted at a time, do not exceed maximum junction temperature specification.

**Note 6:**  $C_L$  includes probe and jig capacitance.

**Note 7:** Generator waveform for all tests unless otherwise specified:  $f = 1 \text{ MHz}$ ,  $Z_O = 50\Omega$ ,  $t_r$  and  $t_f$  (0% to 100%)  $\leq 3 \text{ ns}$  for  $IN_{\pm}$ .

**Note 8:**  $t_{SKD1}$  is the magnitude difference in differential propagation delay time between the positive-going-edge and the negative-going-edge of the same channel.

**Note 9:**  $t_{SKD3}$ , part to part skew, is the differential channel-to-channel skew of any event between devices. This specification applies to devices at the same  $V_{DD}$  and within  $5^\circ\text{C}$  of each other within the operating temperature range.

**Note 10:**  $t_{SKD4}$ , part to part skew, is the differential channel-to-channel skew of any event between devices. This specification applies to devices over the recommended operating temperature and voltage ranges, and across process distribution.  $t_{SKD4}$  is defined as  $I_{Max} - I_{Min}$  differential propagation delay.

**Note 11:**  $V_{DD}$  is always higher than  $IN+$  and  $IN-$  voltage.  $IN+$  and  $IN-$  are allowed to have voltage range  $-0.05\text{V}$  to  $+2.35\text{V}$  when  $V_{DD} = 2.7\text{V}$  and  $|V_{ID}| / 2$  to  $V_{DD} - 0.3\text{V}$  when  $V_{DD} = 3.0\text{V}$  to  $3.6\text{V}$ .  $V_{ID}$  is not allowed to be greater than  $100 \text{ mV}$  when  $V_{CM} = 0.05\text{V}$  to  $2.35\text{V}$  when  $V_{DD} = 2.7\text{V}$  or when  $V_{CM} = |V_{ID}| / 2$  to  $V_{DD} - 0.3\text{V}$  when  $V_{DD} = 3.0\text{V}$  to  $3.6\text{V}$ .

**Note 12:**  $f_{MAX}$  generator input conditions:  $t_r = t_f < 1 \text{ ns}$  (0% to 100%), 50% duty cycle, differential (1.05V to 1.35 peak to peak). Output criteria: 60%/40% duty cycle,  $V_{OL}$  (max 0.4V),  $V_{OH}$  (min 2.4V), load =  $15 \text{ pF}$  (stray plus probes). The parameter is guaranteed by design. The limit is based on the statistical analysis of the device over the PVT range by the transition times ( $t_{TLH}$  and  $t_{THL}$ ).

## Parameter Measurement Information

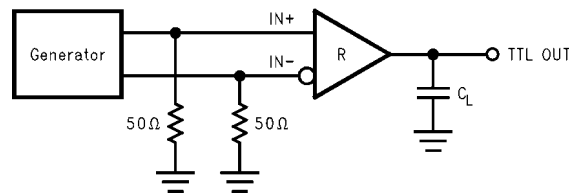

20015003

FIGURE 1. Receiver Propagation Delay and Transition Time Test Circuit

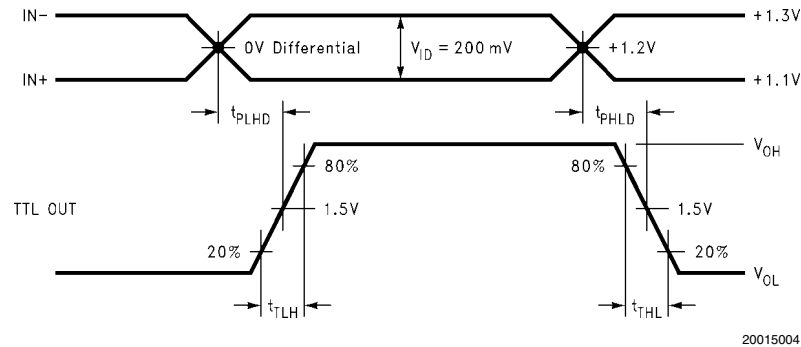

FIGURE 2. Receiver Propagation Delay and Transition Time Waveforms

## Typical Applications

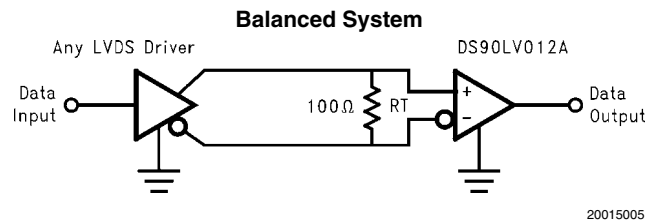

FIGURE 3. Point-to-Point Application (DS90LV012A)

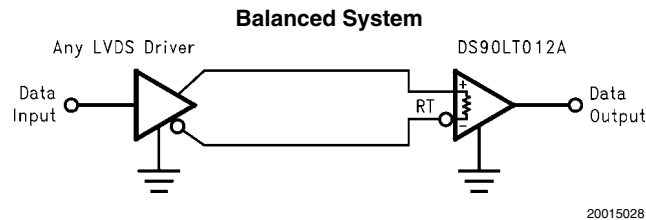

FIGURE 4. Point-to-Point Application (DS90LT012A)

## Applications Information

General application guidelines and hints for LVDS drivers and receivers may be found in the following application notes: LVDS Owner's Manual (lit #550062-002), AN-808, AN-977, AN-971, AN-916, AN-805, AN-903.

LVDS drivers and receivers are intended to be primarily used in an uncomplicated point-to-point configuration as is shown in Figure 3. This configuration provides a clean signaling environment for the fast edge rates of the drivers. The receiver is connected to the driver through a balanced media which may be a standard twisted pair cable, a parallel pair cable, or simply PCB traces. Typically the characteristic impedance of the media is in the range of 100Ω. A termination resistor of 100Ω should be selected to match the media, and is located as close to the receiver input pins as possible. The termination resistor converts the driver output (current mode) into a voltage that is detected by the receiver. Other configurations are possible such as a multi-receiver configuration, but the effects of a mid-stream connector(s), cable stub(s), and other impedance discontinuities as well as ground shifting, noise margin limits, and total termination loading must be taken into account.

The DS90LV012A and DS90LT012A differential line receivers are capable of detecting signals as low as 100 mV, over a ±1V common-mode range centered around +1.2V. This is related to the driver offset voltage which is typically +1.2V. The driven signal is centered around this voltage and may shift ±1V around this center point. The ±1V shifting may be the result of a ground potential difference between the driver's ground reference and the receiver's ground reference, the common-mode effects of coupled noise, or a combination of the two. The AC parameters of both receiver input pins are optimized for a recommended operating input voltage range of 0V to +2.4V (measured from each pin to ground). The device will operate for receiver input voltages up to  $V_{DD}$ , but exceeding  $V_{DD}$  will turn on the ESD protection circuitry which will clamp the bus voltages.

### POWER DECOUPLING RECOMMENDATIONS

Bypass capacitors must be used on power pins. Use high frequency ceramic (surface mount is recommended) 0.1μF and 0.001μF capacitors in parallel at the power supply pin with the smallest value capacitor closest to the device supply pin. Additional scattered capacitors over the printed circuit board will improve decoupling. Multiple vias should be used to connect

the decoupling capacitors to the power planes. A 10 $\mu$ F (35V) or greater solid tantalum capacitor should be connected at the power entry point on the printed circuit board between the supply and ground.

### PC BOARD CONSIDERATIONS

Use at least 4 PCB board layers (top to bottom): LVDS signals, ground, power, TTL signals.

Isolate TTL signals from LVDS signals, otherwise the TTL signals may couple onto the LVDS lines. It is best to put TTL and LVDS signals on different layers which are isolated by a power/ground plane(s).

Keep drivers and receivers as close to the (LVDS port side) connectors as possible.

For PC board considerations for the LLP package, please refer to application note AN-1187 "Leadless Leadframe Package." It is important to note that to optimize signal integrity (minimize jitter and noise coupling), the LLP thermal land pad, which is a metal (normally copper) rectangular region located under the package, should be attached to ground and match the dimensions of the exposed pad on the PCB (1:1 ratio).

### DIFFERENTIAL TRACES

Use controlled impedance traces which match the differential impedance of your transmission medium (ie. cable) and termination resistor. Run the differential pair trace lines as close together as possible as soon as they leave the IC (stubs should be < 10mm long). This will help eliminate reflections and ensure noise is coupled as common-mode. In fact, we have seen that differential signals which are 1mm apart radiate far less noise than traces 3mm apart since magnetic field cancellation is much better with the closer traces. In addition, noise induced on the differential lines is much more likely to appear as common-mode which is rejected by the receiver.

Match electrical lengths between traces to reduce skew. Skew between the signals of a pair means a phase difference between signals which destroys the magnetic field cancellation benefits of differential signals and EMI will result! (Note that the velocity of propagation,  $v = c/E_r$ , where  $c$  (the speed of light) = 0.2997mm/ps or 0.0118 in/ps). Do not rely solely on the autoroute function for differential traces. Carefully review dimensions to match differential impedance and provide isolation for the differential lines. Minimize the number of vias and other discontinuities on the line.

Avoid 90° turns (these cause impedance discontinuities). Use arcs or 45° bevels.

Within a pair of traces, the distance between the two traces should be minimized to maintain common-mode rejection of

the receivers. On the printed circuit board, this distance should remain constant to avoid discontinuities in differential impedance. Minor violations at connection points are allowable.

### TERMINATION

DS90LV012A:

Use a termination resistor which best matches the differential impedance or your transmission line. The resistor should be between 90 $\Omega$  and 130 $\Omega$ . Remember that the current mode outputs need the termination resistor to generate the differential voltage. LVDS will not work without resistor termination. Typically, connecting a single resistor across the pair at the receiver end will suffice.

Surface mount 1% - 2% resistors are the best. PCB stubs, component lead, and the distance from the termination to the receiver inputs should be minimized. The distance between the termination resistor and the receiver should be < 10mm (12mm MAX).

DS90LT012A:

The DS90LT012A integrates the terminating resistor for point-to-point applications. The resistor value will be between 90 $\Omega$  and 133 $\Omega$ .

### THRESHOLD

The LVDS Standard (ANSI/TIA/EIA-644-A) specifies a maximum threshold of  $\pm 100$ mV for the LVDS receiver. The DS90LV012A and DS90LT012A support an enhanced threshold region of  $-100$ mV to 0V. This is useful for fail-safe biasing. The threshold region is shown in the Voltage Transfer Curve (VTC) in Figure 5. The typical DS90LV012A or DS90LT012A LVDS receiver switches at about  $-30$ mV. Note that with  $V_{ID} = 0$ V, the output will be in a HIGH state. With an external fail-safe bias of  $+25$ mV applied, the typical differential noise margin is now the difference from the switch point to the bias point. In the example below, this would be 55mV of Differential Noise Margin ( $+25$ mV  $- (-30$ mV)). With the enhanced threshold region of  $-100$ mV to 0V, this small external fail-safe biasing of  $+25$ mV (with respect to 0V) gives a DNM of a comfortable 55mV. With the standard threshold region of  $\pm 100$ mV, the external fail-safe biasing would need to be  $+25$ mV with respect to  $+100$ mV or  $+125$ mV, giving a DNM of 155mV which is stronger fail-safe biasing than is necessary for the DS90LV012A or DS90LT012A. If more DNM is required, then a stronger fail-safe bias point can be set by changing resistor values.

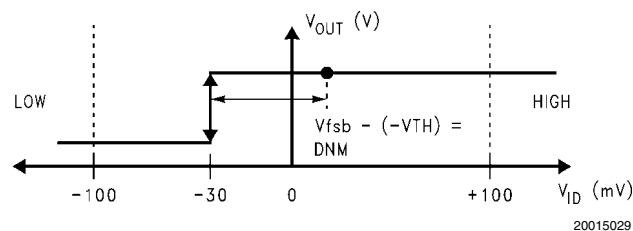

FIGURE 5. VTC of the DS90LV012A and DS90LT012A LVDS Receivers

### FAIL-SAFE FEATURE

The LVDS receiver is a high gain, high speed device that amplifies a small differential signal (20mV) to CMOS logic levels. Due to the high gain and tight threshold of the receiver, care

should be taken to prevent noise from appearing as a valid signal.

The receiver's internal fail-safe circuitry is designed to source/sink a small amount of current, providing fail-safe protection

(a stable known state of HIGH output voltage) for floating, terminated or shorted receiver inputs.

1. **Open Input Pins.** The DS90LV012A and DS90LT012A are single receiver devices. It is not required to tie the receiver inputs to ground or any supply voltage. Internal failsafe circuitry will guarantee a HIGH, stable output state for open inputs.
2. **Terminated Input.** If the driver is disconnected (cable unplugged), or if the driver is in a power-off condition, the receiver output will again be in a HIGH state, even with the end of cable 100Ω termination resistor across the input pins. The unplugged cable can become a floating antenna which can pick up noise. If the cable picks up more than 10mV of differential noise, the receiver may see the noise as a valid signal and switch. To insure that any noise is seen as common-mode and not differential, a balanced interconnect should be used. Twisted pair cable will offer better balance than flat ribbon cable.
3. **Shorted Inputs.** If a fault condition occurs that shorts the receiver inputs together, thus resulting in a 0V differential input voltage, the receiver output will remain in a HIGH state. Shorted input fail-safe is not supported across the common-mode range of the device (GND to 2.4V). It is only supported with inputs shorted and no external common-mode voltage applied.

External lower value pull up and pull down resistors (for a stronger bias) may be used to boost fail-safe in the presence of higher noise levels. The pull up and pull down resistors should be in the 5kΩ to 15kΩ range to minimize loading and waveform distortion to the driver. The common-mode bias point should be set to approximately 1.2V (less than 1.75V) to be compatible with the internal circuitry.

## Pin Descriptions

Package Pin Number		Pin Name	Description
SOT23	LLP		
4	1	IN-	Inverting receiver input pin
3	3	IN+	Non-inverting receiver input pin
5	8	TTL OUT	Receiver output pin
1	6	V <sub>DD</sub>	Power supply pin, +3.3V ± 0.3V
2	2, 7	GND	Ground pin
	4, 5	NC	No connect

## Ordering Information

Operating Temperature	Package Type/ Number	Order Numbers
-40°C to +85°C	MF05A	DS90LV012ATMF, DS90LT012ATMF
	LDA08A	DS90LV012ATLD, DS90LT012ATLD

The DS90LV012A and DS90LT012A are compliant to the original ANSI EIA/TIA-644 specification and is also compliant to the new ANSI EIA/TIA-644-A specification with the exception the newly added  $\Delta I_{IN}$  specification. Due to the internal fail-safe circuitry,  $\Delta I_{IN}$  cannot meet the 6μA maximum specified. This exception will not be relevant unless more than 10 receivers are used.

Additional information on fail-safe biasing of LVDS devices may be found in AN-1194.

### PROBING LVDS TRANSMISSION LINES

Always use high impedance (> 100kΩ), low capacitance (< 2 pF) scope probes with a wide bandwidth (1 GHz) scope. Improper probing will give deceiving results.

### CABLES AND CONNECTORS, GENERAL COMMENTS

When choosing cable and connectors for LVDS it is important to remember:

Use controlled impedance media. The cables and connectors you use should have a matched differential impedance of about 100Ω. They should not introduce major impedance discontinuities.

Balanced cables (e.g. twisted pair) are usually better than unbalanced cables (ribbon cable, simple coax) for noise reduction and signal quality. Balanced cables tend to generate less EMI due to field canceling effects and also tend to pick up electromagnetic radiation a common-mode (not differential mode) noise which is rejected by the receiver.

For cable distances < 0.5M, most cables can be made to work effectively. For distances  $0.5M \leq d \leq 10M$ , CAT 3 (category 3) twisted pair cable works well, is readily available and relatively inexpensive.

**Physical Dimensions** inches (millimeters) unless otherwise noted

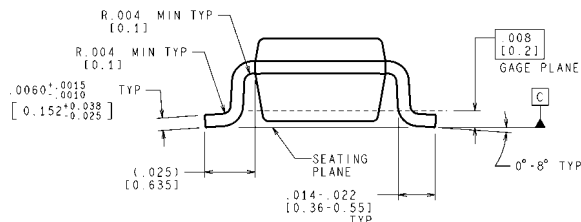
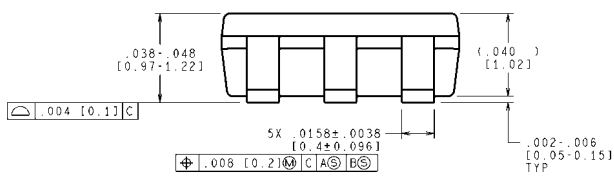
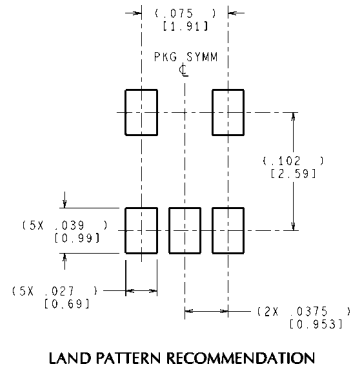
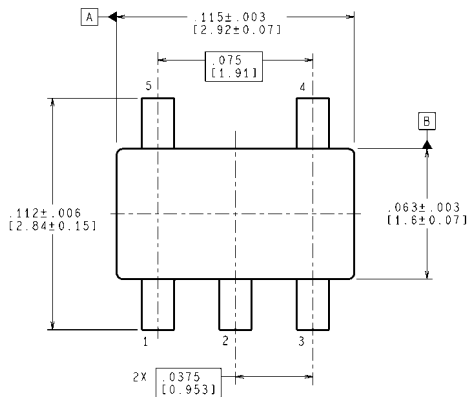

CONTROLLING DIMENSION IS INCH  
 VALUES IN [ ] ARE MILLIMETERS  
 DIMENSIONS IN ( ) FOR REFERENCE ONLY

MF05A (Rev C)

**5-Lead SOT23, JEDEC MO-178, 1.6mm**  
**Order Number DS90LV012ATMF, DS90LT012ATMF**  
**NS Package Number MF05A**

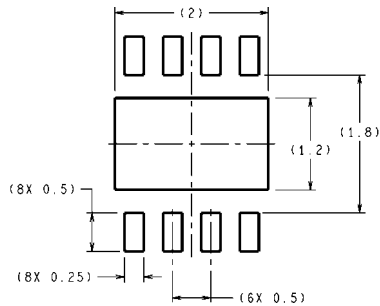

DIMENSIONS ARE IN MILLIMETERS

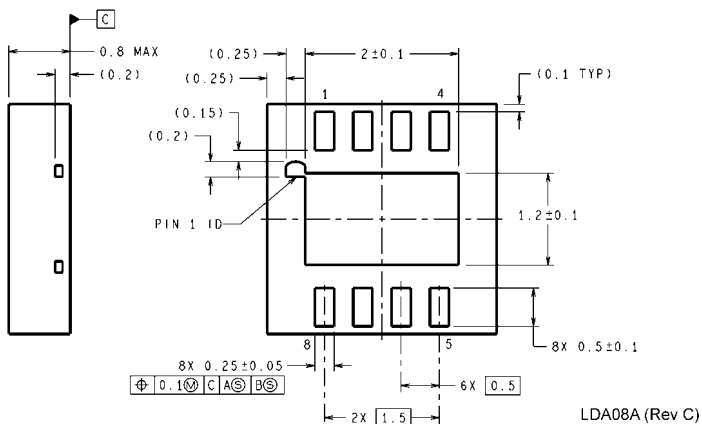
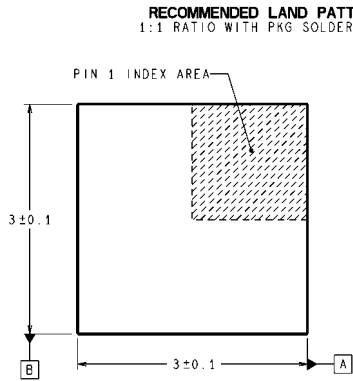

LDA08A (Rev C)

**LLP-8, 3mm x 3mm Body**  
**Order Number DS90LV012ATLD, DS90LT012ATLD**  
**NS Package Number LDA08A**



## Notes

For more National Semiconductor product information and proven design tools, visit the following Web sites at:

Products		Design Support	
Amplifiers	<a href="http://www.national.com/amplifiers">www.national.com/amplifiers</a>	WEBENCH	<a href="http://www.national.com/webench">www.national.com/webench</a>
Audio	<a href="http://www.national.com/audio">www.national.com/audio</a>	Analog University	<a href="http://www.national.com/AU">www.national.com/AU</a>
Clock Conditioners	<a href="http://www.national.com/timing">www.national.com/timing</a>	App Notes	<a href="http://www.national.com/appnotes">www.national.com/appnotes</a>
Data Converters	<a href="http://www.national.com/adc">www.national.com/adc</a>	Distributors	<a href="http://www.national.com/contacts">www.national.com/contacts</a>
Displays	<a href="http://www.national.com/displays">www.national.com/displays</a>	Green Compliance	<a href="http://www.national.com/quality/green">www.national.com/quality/green</a>
Ethernet	<a href="http://www.national.com/ethernet">www.national.com/ethernet</a>	Packaging	<a href="http://www.national.com/packaging">www.national.com/packaging</a>
Interface	<a href="http://www.national.com/interface">www.national.com/interface</a>	Quality and Reliability	<a href="http://www.national.com/quality">www.national.com/quality</a>
LVDS	<a href="http://www.national.com/lvds">www.national.com/lvds</a>	Reference Designs	<a href="http://www.national.com/refdesigns">www.national.com/refdesigns</a>
Power Management	<a href="http://www.national.com/power">www.national.com/power</a>	Feedback	<a href="http://www.national.com/feedback">www.national.com/feedback</a>
Switching Regulators	<a href="http://www.national.com/switchers">www.national.com/switchers</a>		
LDOs	<a href="http://www.national.com/ldo">www.national.com/ldo</a>		
LED Lighting	<a href="http://www.national.com/led">www.national.com/led</a>		
PowerWise	<a href="http://www.national.com/powerwise">www.national.com/powerwise</a>		
Serial Digital Interface (SDI)	<a href="http://www.national.com/sdi">www.national.com/sdi</a>		
Temperature Sensors	<a href="http://www.national.com/tempsensors">www.national.com/tempsensors</a>		
Wireless (PLL/VCO)	<a href="http://www.national.com/wireless">www.national.com/wireless</a>		

THE CONTENTS OF THIS DOCUMENT ARE PROVIDED IN CONNECTION WITH NATIONAL SEMICONDUCTOR CORPORATION ("NATIONAL") PRODUCTS. NATIONAL MAKES NO REPRESENTATIONS OR WARRANTIES WITH RESPECT TO THE ACCURACY OR COMPLETENESS OF THE CONTENTS OF THIS PUBLICATION AND RESERVES THE RIGHT TO MAKE CHANGES TO SPECIFICATIONS AND PRODUCT DESCRIPTIONS AT ANY TIME WITHOUT NOTICE. NO LICENSE, WHETHER EXPRESS, IMPLIED, ARISING BY ESTOPPEL OR OTHERWISE, TO ANY INTELLECTUAL PROPERTY RIGHTS IS GRANTED BY THIS DOCUMENT.

TESTING AND OTHER QUALITY CONTROLS ARE USED TO THE EXTENT NATIONAL DEEMS NECESSARY TO SUPPORT NATIONAL'S PRODUCT WARRANTY. EXCEPT WHERE MANDATED BY GOVERNMENT REQUIREMENTS, TESTING OF ALL PARAMETERS OF EACH PRODUCT IS NOT NECESSARILY PERFORMED. NATIONAL ASSUMES NO LIABILITY FOR APPLICATIONS ASSISTANCE OR BUYER PRODUCT DESIGN. BUYERS ARE RESPONSIBLE FOR THEIR PRODUCTS AND APPLICATIONS USING NATIONAL COMPONENTS. PRIOR TO USING OR DISTRIBUTING ANY PRODUCTS THAT INCLUDE NATIONAL COMPONENTS, BUYERS SHOULD PROVIDE ADEQUATE DESIGN, TESTING AND OPERATING SAFEGUARDS.

EXCEPT AS PROVIDED IN NATIONAL'S TERMS AND CONDITIONS OF SALE FOR SUCH PRODUCTS, NATIONAL ASSUMES NO LIABILITY WHATSOEVER, AND NATIONAL DISCLAIMS ANY EXPRESS OR IMPLIED WARRANTY RELATING TO THE SALE AND/OR USE OF NATIONAL PRODUCTS INCLUDING LIABILITY OR WARRANTIES RELATING TO FITNESS FOR A PARTICULAR PURPOSE, MERCHANTABILITY, OR INFRINGEMENT OF ANY PATENT, COPYRIGHT OR OTHER INTELLECTUAL PROPERTY RIGHT.

### LIFE SUPPORT POLICY

**NATIONAL'S PRODUCTS ARE NOT AUTHORIZED FOR USE AS CRITICAL COMPONENTS IN LIFE SUPPORT DEVICES OR SYSTEMS WITHOUT THE EXPRESS PRIOR WRITTEN APPROVAL OF THE CHIEF EXECUTIVE OFFICER AND GENERAL COUNSEL OF NATIONAL SEMICONDUCTOR CORPORATION.** As used herein:

Life support devices or systems are devices which (a) are intended for surgical implant into the body, or (b) support or sustain life and whose failure to perform when properly used in accordance with instructions for use provided in the labeling can be reasonably expected to result in a significant injury to the user. A critical component is any component in a life support device or system whose failure to perform can be reasonably expected to cause the failure of the life support device or system or to affect its safety or effectiveness.

National Semiconductor and the National Semiconductor logo are registered trademarks of National Semiconductor Corporation. All other brand or product names may be trademarks or registered trademarks of their respective holders.

Copyright© 2008 National Semiconductor Corporation

For the most current product information visit us at [www.national.com](http://www.national.com)



**National Semiconductor  
Americas Technical  
Support Center**  
Email:  
[new.feedback@nsc.com](mailto:new.feedback@nsc.com)  
Tel: 1-800-272-9959

**National Semiconductor Europe  
Technical Support Center**  
Email: [europe.support@nsc.com](mailto:europe.support@nsc.com)  
German Tel: +49 (0) 180 5010 771  
English Tel: +44 (0) 870 850 4288

**National Semiconductor Asia  
Pacific Technical Support Center**  
Email: [ap.support@nsc.com](mailto:ap.support@nsc.com)

**National Semiconductor Japan  
Technical Support Center**  
Email: [jpn.feedback@nsc.com](mailto:jpn.feedback@nsc.com)