

Table of Contents

NANONICS Nanominiature Connectors

Introduction 5004, 5005

Strip Connectors 5006

Strip Connectors Standard Part Numbering System 5007

DUALOBE Single Row Connectors 5008

DUALOBE Two Row Connectors 5009

DUALOBE Connectors Standard Part Numbering System 5010, 5011

N-Series Circular Connectors 5012

Environmentally Sealed Quick Disconnect Circular Connectors 5013

Environmentally Sealed Threaded Coupling Circular Connectors 5014

50 Ohm Coaxial Connector System 5015

Coax Connectors Standard Part Numbering System 5016

Environmental Connectors 5017

Hermetic Connectors 5018

Filtered Connectors 5019

Flex Circuit, Ribbon Cable Terminations 5020, 5021

Blindmate Connectors 5022

Part Number Index Cross Reference 5023-5031

MICRODOT Microminiature D Connectors

Introduction 5032

MCK/MCD/MCDM Series Metal and Plastic Shell Connectors 5033

How To Specify MCK and MCD Connectors 5034

Contact Arrangements 5035

MCK Series Metal Shell Connectors 5036

MCK Series Metal Shell Connectors Panel Mounting — Cutout Dimensions 5037

MCD Series Plastic Shell Connectors 5038, 5039

MCD Series Plastic Shell Connectors Panel Mounting — Cutout Dimensions 5040

Mounting and Coupling Hardware 5041, 5042

MCK Transition Blocks 5043-5048

MCK ST2 Series Straight Mount PCB Connectors 5049-5051

MCDM Series Metal Shell Connectors 5052, 5053

MCDM Series Metal Shell RF COMBOMATE Connectors 5054-5056

MCDM Series Metal Shell Connectors Panel Mounting — Cutout Dimensions 5057

MIL-PRF-83513 Cross Reference 5058-5062

MICRODOT Circular Connectors

Introduction 5063, 5064

MARC 43 Series Connectors 5065-5071

MARC 53 Series Connectors 5072-5081

MARC 63 Series Connectors 5082-5085

Connector Contacts/Coaxial Contacts 5086, 5087

Contact Cavity Sealing Plugs 5088

Assembly Tools 5089

MARC 73 Series Connectors 5090-5094

MQR Series — Microminiature Circular Connectors 5095, 5096

MTC Series — Microminiature Circular Connectors 5097, 5098

Table of Contents (Continued)

AMPLIMITE Connectors (Subminiature D Connectors)

Introduction 5099, 5100

Series 109 Connectors (Standard Density)

 Insert Arrangements, Performance Specifications, and
 Technical Documents List 5101

 Crimp Contacts 5102

 Posted Contacts 5103, 5104

 MIL Qualified Crimp Connectors 5105

 Industrial Grade Crimp Connectors 5106

 Non-Magnetic NASA Qualified Connectors 5107, 5108

 Blindmate Plugs 5109

 MIL Qualified Straight Printed Circuit Board Connectors 5110

 Industrial Grade Straight Printed Circuit Board Connectors 5111

 Industrial Grade "Make First Break Last" Sub D Connectors 5112

 MIL Qualified Right-Angle Printed Circuit Board Connectors 5113, 5114

 Industrial Grade Right-Angle Printed Circuit Board Connectors 5115-5117

 Industrial Grade Right-Angle Printed Circuit Board Connectors with
 One Piece Insert 5118, 5119

 Solder Cup Connectors 5120

 Connector Savers 5121

Coax Mix

 Power/Coax/Signal Combination Connectors 5122

 Boardmount Power/Coax/Signal Combination Connectors 5123

 Size 8 Power Contacts 5124

 RF Contacts 5125, 5126

Series 90 Connectors (High Density)

 Insert Arrangements, Performance Specifications, and
 Technical Documents List 5127

 Crimp Contacts 5128

 Posted Contacts 5129

 MIL Qualified Crimp Connectors 5130, 5131

 Industrial Grade Crimp Connectors 5130, 5131

 Non-Magnetic NASA Qualified Connectors 5132, 5133

 Blindmate Plugs 5134

 Industrial Grade Straight Printed Circuit Board Connectors 5135

 Right-Angle Printed Circuit Board Connectors 5136

 Connector Savers 5137

ULTRA-LITE AMPLIMITE Connectors

 Introduction 5138

 Series 109 Connectors 5139

 Series 90 Connectors 5140

 ULTRA-LITE AMPLIMITE Connectors vs. NASA and DSCC Part Number
 Comparison Charts 5141

 Application Tooling 5142

 Mating and Mounting Specifications 5143

 Printed Circuit Board Layouts

 Series 109 (Standard Density) 5144

 Series 90 (High Density) 5145

 Power/Coax/Signal Mix 5146, 5147

 Accessories 5148-5150

Cross Reference

 MIL-DTL-24308 vs. AMP 5151-5155

 M39029, M22520 and M81969 vs. AMP 5155

 NASA vs. AMP 5156, 5157

Table of Contents (Continued)

“G” Series Modular Connectors

Introduction 5158, 5159
 Module Specifications and Multimate Contacts 5160
 Signal Contacts 5161, 5162
 Multimate Contacts 5163-5166
 Coaxial Contacts 5167, 5168
 Shell Specifications 5169-5171
 Accessories 5172, 5173
 Application Tooling 5174-5176

High Density Rectangular Connectors

Introduction and Specifications 5177
 Contacts 5178
 Housings 5179-5181
 Printed Circuit Board Connector 5182
 Preloaded Housings, .025 x .025 [0.64 x 0.64] Posted Contacts
 for Automatic Wiring 5183-5185
 Accessories 5186, 5187
 Application Tooling 5188, 5189

MTC High Performance Modular Rectangular Connectors

Introduction 5190
 20-Cavity Inserts 5191, 5192
 5-Cavity Inserts 5193
 Hybrid Inserts 5194
 MTC Shells Ordering Information 5195
 Accessories 5196

Terminal Junction System (MIL-T-81714 and Commercial)

Introduction 5197
 Performance Specifications 5198
 Contacts, Sealing Plugs and Assembly Tools 5198
 Feedback and Feedthru Terminal Junction Modules 5199
 Feedback Terminal Junction Modules 5200-5202
 Feedthru Terminal Junction Modules 5203
 Feedback 5204
 Wire Splices 5205
 Electronic Module Blocks and Splices 5206
 Electronic Module Blocks 5207, 5208
 Commercial Electronic Splices 5209
 Electronic Module Blocks and Splices Part Numbering Information 5210
 Military Cross Reference 5211-5217

Introduction

Product Facts

- High density packaging features
- Minimum mass
- MIL spec or Commercial-Off-The-Shelf (COTS) options
- Durable performance, rugged
- Outstanding electrical performance; low contact resistance
- Withstands shock and vibration
- Expanded temperature range
- Reliable mass crimp terminations
- Crimp any material, shape, finish
- Extensive design options
- Other options:
 - EMI/RFI filter
 - SMT or thru-hole
 - Harness assemblies
 - Mounting brackets
 - Custom modifications
 - Backshells
 - Lo-profile
 - Headers
 - Flex circuit attached
 - Mixed signal technology



NANONICS Nanominiature Connectors and associated cable systems are designed for size and weight reduction while maintaining a high level of reliability and ruggedness. The contact system is used throughout the product family to enhance long-term performance and quality of the system in difficult applications. Connector manufacturing utilizes only materials that are selected to pass Space and Military Specifications. Fabrication of the connectors includes machine controlled crimping of the leads or wires directly to the pin or socket contacts prior to final connector assembly. These high-end Nanominiature connectors are designed into numerous configurations that range from wired nano-strips to complex flex circuit interconnect systems and cover the circuit spectrum from dc. to rf. applications. Customized versions of each design type can be requested. Application Engineering and custom harness designs are available to help resolve fitting previously large interconnection systems into smaller and smaller spaces.

General Specifications

Military — meets *DSCC specs. 94031 through 94046

Goldbore Contacts

Material — Beryllium copper

Plating — Nickel over gold

Contact Current — 4 Amps continuous

Resistance — .003-.008 ohms

Engage Force — 1.0 oz. average/contact

Wire size/Current — 30 AWG & smaller/1 Amp

Contact Pitch — .025 [.635], .0125 [.317] for 2 row

Insulators — Polyphenylene sulfide or liquid crystal polymer

Metal Shells — 6061 Aluminum with electroless nickel plate; 303 stainless steel; other metals & plating available

Dielectric WV — Sea level 70,000 ft. [21,336 m]

Plastic	500VDC	250VDC
Metal	400VDC	200VDC

Insulation Resistance — 1000 Megohms

Vibration & Shock — *DSCC 94031 - 94046 & MIL-C-83513

Environment — *DSCC 94031 - 94046 & MIL-C-83513 (Tested over 4000 engagements)

Polarization — DUALLOBE, pins, keys

Temperature Range — -328°F to +437°F [-200°C to +225°C]

Layouts — 2-65 positions

Coupling — Jackscrews; friction

Outgassing — Meets Sp-R-0022

*DSCC-Defense Supply Center, Columbus. Formerly, DESC, Dayton, Ohio

Introduction (Continued)



Strip

- Smallest of connectors
- Friction coupling
- Guide pin polarization
- SMT, or thru-hole
- Wire, flex and ribbon options

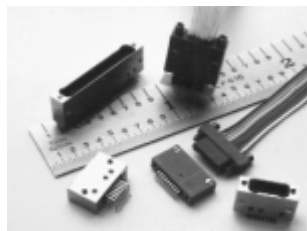

DUALLOBE Connector

- Polarized scoop-proof mating
- Blindmating with ease
- Coupling with jackscrews
- Panel mount, SMT, thru-hole
- MIL Specs or COTS

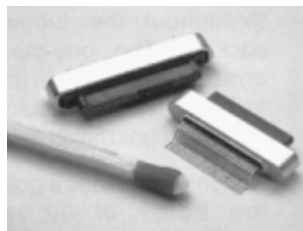

Hermetic "H" Series

- Hermetic per MIL-STD-202
- MIL-STD-883; 1X10-8 CC/sec leak rate
- 5-60 positions, larger sizes as assemblies
- Mate with NANONICS standard DUALLOBE receptacles

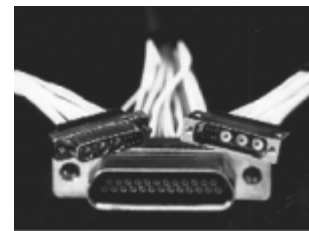

Nano-Coaxial Connectors

- More than 1/3 smaller than Micro-Ds
- Custom mixed signal systems
- Uses 32 AWG coax
- Maintains low cross talk
- Improved analog signal control



Environmentally Sealed Circulars

- Quick Disconnect or Thread Coupling Plugs
- Panel Mount and Flush Mount Receptacles
- Sizes include: 7, 19 and 44 position
- Nano-Sized Shells and .025 [0.635] pitch connections

The Contact System

The contact system features burnished gold bores and surfaces throughout the tubular pins and sockets. The one-piece seamless contacts are fabricated using techniques that result in superior, gold finish contacts.

Tyco Electronics provides a typical gold thickness of 30 micro-inches (.000030 [0.00076]). In addition, seamless contact bores further contribute to crimps of outstanding quality and durability (i.e., gas tight and intrusion proof). Innovative receptacle design effectively doubles the electrical "creep" distance between sockets permitting higher voltage limits. The contact system also minimizes bias to resonate, thus, vibration and shock induced "opens" are virtually eliminated.

Excellent physical and electrical mating characteristics are obtained via a low engaging force that maintains an effective contact wiping action during mating. Problems associated with special mating tools or jigs and zero force engaging techniques (i.e., ZIF) are eliminated.

Socket Contact

The socket is the active element. It incorporates the necessary spring action to promote low contact resistance and long life endurance. The socket is a seamless one piece tubular part without slots or other traditional means to provide the spring action. Precision manufacturing techniques produce a highly reliable and simple contact. A unique burnished Goldbore finish is common to the crimp barrels of both contacts and the socket engaging bore. The gold finish provides contact integrity for superior reliability and environmental performance.

Pin Contact

The pin contact is fabricated employing ultra precision methods producing a blind-bore seamless pin

with a burnished gold finish on ID and OD surfaces. The pin, being approximately .0125 [0.32] in diameter, is not as strong as the socket. Consequently, the pin has been recessed within the insulator, thereby permitting the stronger member (the socket) to be exposed.

Termination

Connectors are normally terminated at the factory per specifications. Thus, no special techniques or termination tools are required by the customer. Tyco Electronics can also provide factory terminated harness assemblies (including flex circuits) to your specifications. All terminated connectors and harness assemblies are tested and certified prior to shipment. Both contacts embody closed crimp bores that provide the optimum shape for a variety of conductor shapes and materials, including 30 AWG thru 40 and smaller.

Crimp termination accommodates solid and stranded conductors as well as flat conductors and ribbon cable. Crimps are gas-tight and intrusion proof.

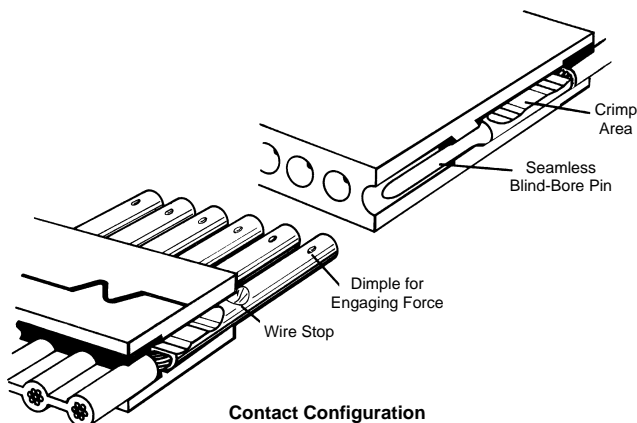

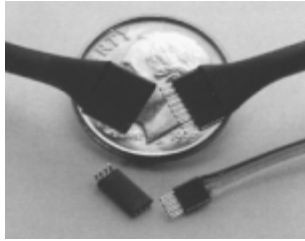

NANONICS Strip Connectors provide dramatic reduction in size and weight, and enable reduction in board space requirements while retaining DUALLOBE Connector series performance.

Strips are useful in applications such as hearing aids, hand-held communication devices, flex terminations, and high density electronics where packaging space is at a premium.

Strips are available for PCB surface mount and thru-hole applications and may be terminated with ribbon cable, flex circuits and a variety of insulated wire, 30 AWG thru 42 AWG and smaller. Contact Tyco Electronics for details.

Strip Connectors

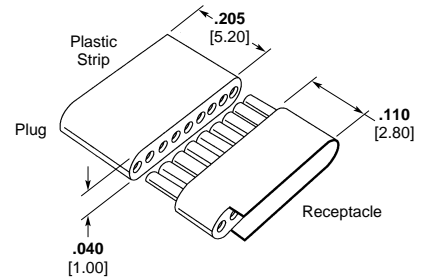
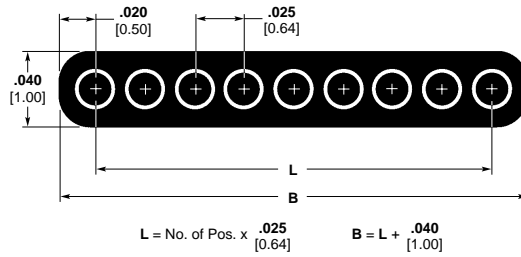

Polarization

Polarization of the strips is accomplished with the use of polarizing guide posts.

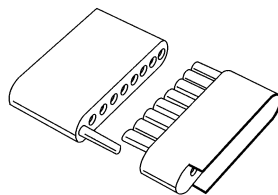

"T" Shown

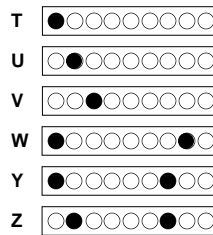

Polarizing Guide Post (PGP) Positions

Stocked Sizes

No. of Positions	Dimensions	
	L	B
4	.115	.155
	2.92	3.92
9	.240	.280
	6.10	7.10
15	.390	.430
	9.91	10.91

Other sizes available. Contact Tyco Electronics for more information.

9-Position, Single Row, Strip Connector and Plug

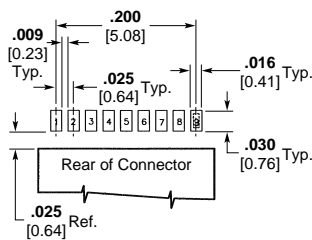
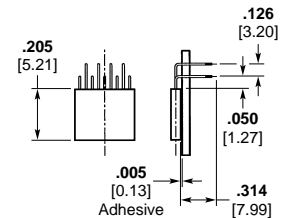
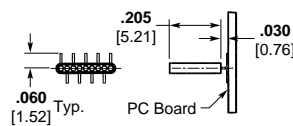
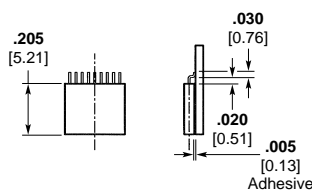

Recommended PC Board Layout

Surface Mount Option

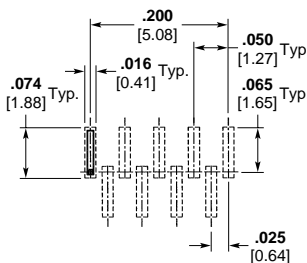

Recommended PC Board Layout

Vertical Surface Mount Option

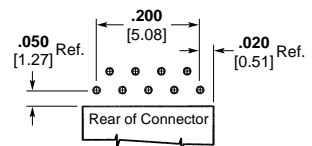

Recommended PC Board Layout

Thru Hole Option

Strip Connectors - Wire Terminations

Class/Row/Type	XXX	XXX	XX	X	XX	XXX	X
USS	Unshrouded, 1 Row, Strip						
Positions							
004	4 Position						
009	9 Position						
015	15 Position						
Configuration							
PC	Plug						
SC	Receptacle						
Conductor Sizes/Strands							
0	28 AWG Solid		3	32 AWG 7 Strand			
1	30 AWG Solid		4	34 AWG 7 Strand			
2	30 AWG 7 Strand						

Polarization	Polarization: (Strip Type Only)
Plug contains guide post Receptacle accepts guide post	<p>T = One Pin </p> <p>U = One Pin </p> <p>V = One Pin </p> <p>W = Two Pin </p> <p>Y = Two Pin </p> <p>Z = Two Pin </p>
Conductor Length	
XXX Three numbers only, length is in inches (i.e. 012 = twelve inches)	
CXX A "C" followed by two numbers, length is in centimeters (i.e. C06 = six centimeters)	
MXX An "M" followed by two numbers, length is in meters (i.e. M02 = two meters)	
Conductor Type	
DX White TEFLON	DM Color Coded TEFLON per MIL-STD-681
DY White PTFE M16878/6	DT White TEFZEL M22759/33
DC Color Coded TEFLON	

Note: See Page 5031 for standard part numbers.

Strip Connectors - Surface Mount and Thru Hole Terminations

Class/Row/Type	XXX	XXX	XX	X
USS	Unshrouded, 1 Row, Strip			
Positions				
004	4 Position			
009	9 Position			
015	15 Position			
Configuration				
B2	Plug, Horizontal SMT			
L2	Receptacle, Horizontal SMT			
C6	Plug, Horizontal Mount, Thru Hole			
M6	Receptacle, Horizontal Mount, Thru Hole			

Polarization	Polarization: (Strip Type Only)
Plug contains guide post Receptacle accepts guide post	<p>T = One Pin </p> <p>U = One Pin </p> <p>V = One Pin </p> <p>W = Two Pin </p> <p>Y = Two Pin </p> <p>Z = Two Pin </p>

Note: See Page 5031 for standard part numbers.

DUALLOBE Single Row Connectors

Options

- Plastic or Metal
- Standard Sizes: 5, 9, 15, 25, 37, and 51
- Factory wired to your specifications, or PC board termination shown in examples
- Contact Tyco Electronics for design specifications

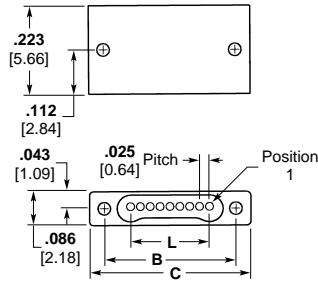
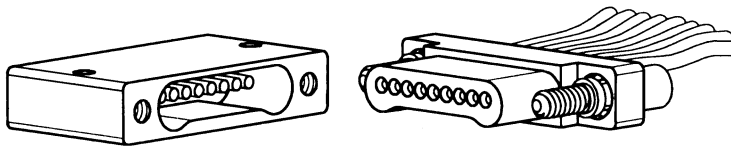

Receptacle

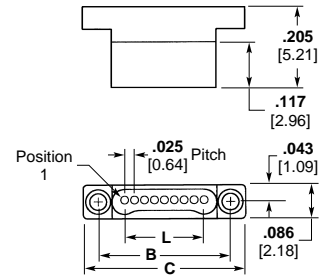

Plug

Size	Dimensions		
	L ±.005 [±0.13]	B ±.005 [±0.13]	C ±.005 [±0.13]
5	.100 2.51	.233 5.87	.308 7.76
9	.200 5.08	.333 8.46	.405 10.29
15	.350 8.89	.483 12.27	.555 14.10
25	.600 15.24	.733 18.62	.805 20.45
37	.900 22.86	1.033 26.24	1.105 28.07
51	1.250 31.75	1.383 35.13	1.455 36.96

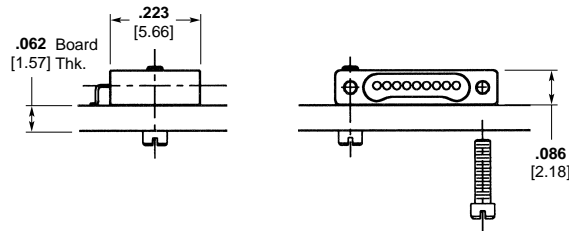

Horizontal Surface Mount

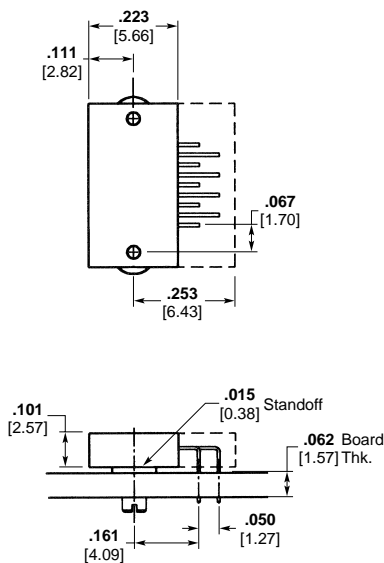

Horizontal Thru Hole

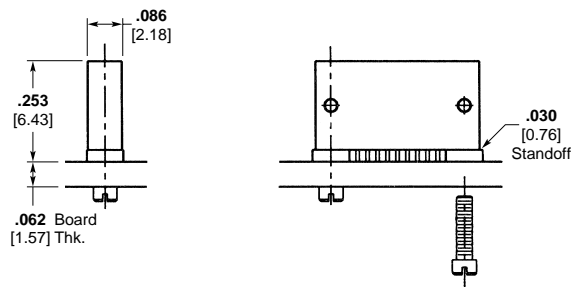

Vertical Surface Mount

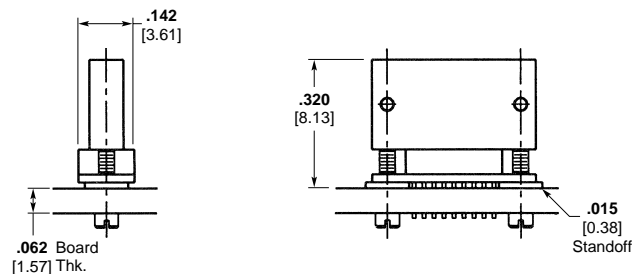

Vertical Thru Hole

DUALLOBE Two Row Connectors

Options

- Plastic or Metal
- Standard Sizes: 9, 15, 25, 37, 51 and 65
- Factory wired to your specifications, or PC board termination shown in examples
- Contact Tyco Electronics for design specifications

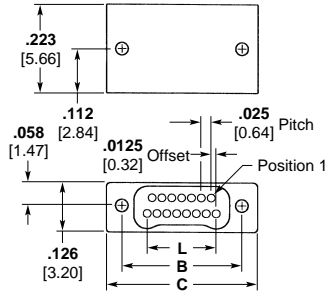
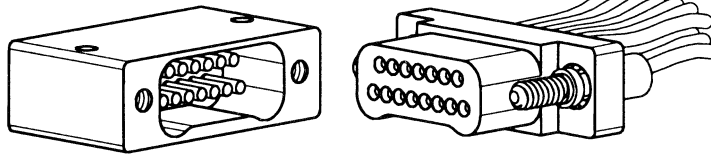

Receptacle

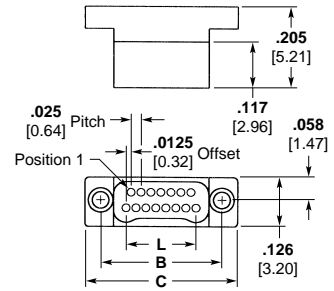

Plug

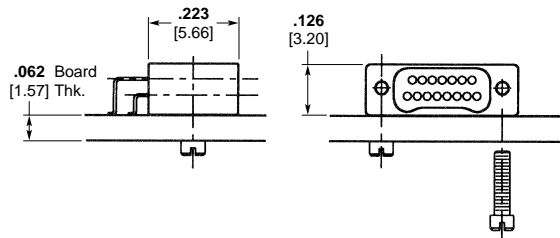

Horizontal Surface Mount

Size	Dimensions		
	L ±.005 [±0.13]	B ±.005 [±0.13]	C ±.005 [±0.13]
9	.100 2.54	.229 5.82	.305 7.75
15	.175 4.45	.304 7.72	.385 9.78
25	.300 7.62	.429 10.90	.510 12.95
37	.450 11.43	.579 14.71	.660 16.76
51	.625 15.88	.754 19.15	.835 21.21
65	.800 20.32	.929 23.60	1.010 25.65

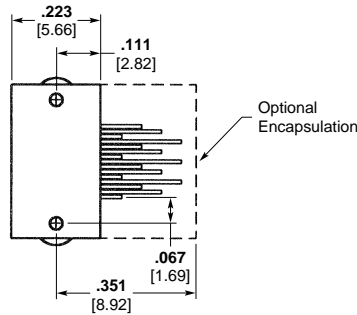

Vertical Surface Mount

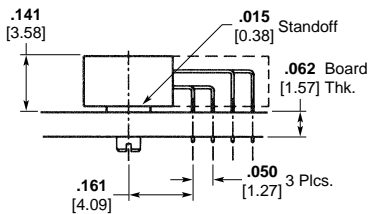
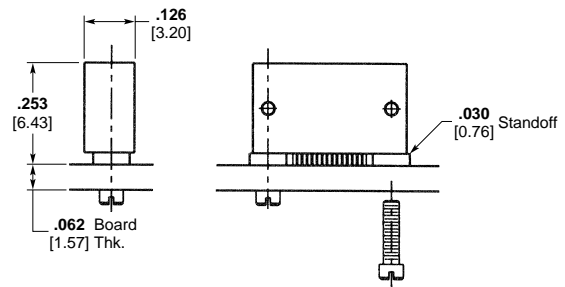

Horizontal Thru Hole

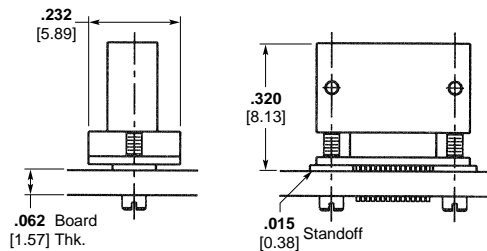

Vertical Thru Hole

DUALOBE Connectors - Jumper Terminations*

Class	X	X	X	XXX	XX	X	XX	XXX	X
J Jumper									
Rows									
S 1 Row									
T 2 Row									
Type									
L LCP (Plastic)									
M Metal (Al; Ni Plate)									
Positions									
005 5 Position (single row only)	037 37 Position								
009 9 Position	051 51 Position								
015 15 Position	065 65 Position (two row only)								
025 25 Position									
Configurations									
PP Plug to Plug, 1 to 1	PD Plug to Plug, low to high in row								
PR Plug to Receptacle, 1 to 1	RR Receptacle to Receptacle, 1 to 1								

*Made to Order

Threads/Jackscrew

Threads (Receptacles Only)	Jackscrews (Plugs Only)
N Thread for 1.0 mm Jackscrews	M 1.0 mm Non Captive Jackscrew
Q Thread for 1.2 mm Jackscrews	N 1.0 mm Captive Jackscrew
	Q 1.2 mm Captive Jackscrew

Conductor Length

XXX	Three numbers only, length is in inches (i.e. 012 = twelve inches)
CXX	A "C" followed by two numbers, length is in centimeters (i.e. C06 = six centimeters)
MXX	An "M" followed by two numbers, length is in meters (i.e. M02 = two meters)

Conductor Type

DX	White TEFLON	DM	Color Coded TEFLON per MIL-STD-681
DY	White PTFE M16878/6	DT	White TEFZEL M22759/33
DC	Color Coded TEFLON	GX	TEFLON Ribbon Cable FEP

Conductor Size/Strands

0	28 AWG Solid	3	32 AWG 7 Strand
1	30 AWG Solid	4	34 AWG 7 Strand
2	30 AWG 7 Strand		

Note: See Page 5024 for standard part numbers.

DUALOBE Connectors - Surface Mount and Thru Hole Terminations

Class	X	X	X	XXX	XX	X	X
S DUALOBE							
Rows							
S 1 Row							
T 2 Row							
Type							
L LCP (Plastic)							
M Metal (Al; Ni Plate)							
Positions							
005 5 Position (single row only)	037 37 Position						
009 9 Position	051 51 Position						
015 15 Position	065 65 Position (two row only)						
025 25 Position							

Threads/Jackscrew

Threads (Receptacles Only)	Jackscrews (Plugs Only)
N Thread for 1.0 mm Jackscrews	M 1.0 mm Non Captive Jackscrew
Q Thread for 1.2 mm Jackscrews	N 1.0 mm Captive Jackscrew
	Q 1.2 mm Captive Jackscrew

Mounting Hardware(Receptacles Only)

A	1.2 mm x .160"	K	1.0 mm x .200" w/ 4 Standoffs
C	1.0 mm x .200" w/ 2 Standoffs	L	1.2 mm x .200" w/ 2 Standoffs
D	1.2 mm x .160" w/ 2 Standoffs	P	1.2 mm x .200" w/ 4 Standoffs
H	1.0 mm x .160"	S	1.0 mm x .160" w/ 2 Standoffs
I	1.2 mm x .200"		

Configuration

B2	Plug, Horizontal SMT
B4	Plug, Vertical SMT
B42	Plug, Vertical SMT, .020" Extended Leads
B44	Plug, Vertical SMT, .040" Extended Leads
L2	Receptacle, Horizontal SMT
L4	Receptacle, Vertical SMT
L42	Receptacle, Vertical SMT, .020" Extended Leads
L44	Receptacle, Vertical SMT, .040" Extended Leads
L8	Receptacle, Vertical SMT w/ integrated standoffs (metal shell only)
L82	Receptacle, Vertical SMT w/ integrated standoffs, .020" Extended Leads (metal shell only)
L84	Receptacle, Vertical SMT w/ integrated standoffs, .040" Extended Leads (metal shell only)
C5	Plug, Vertical Mount, Thru Hole
C6	Plug, Horizontal Mount, Thru Hole
M5	Receptacle, Vertical Mount, Thru Hole
M6	Receptacle, Horizontal Mount, Thru Hole

Note: See Pages 5024-5026 for standard part numbers.

DUALOBE Connectors - Wire Terminations

Note: See Page(s) 5027-5030 for standard part numbers.

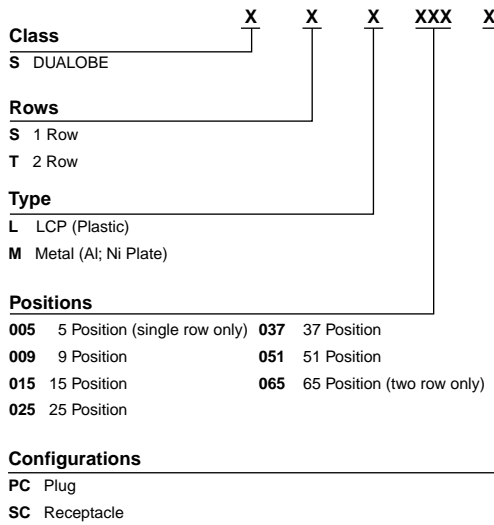

Threads/Jackscrew

Threads (Receptacles Only)		Jackscrews (Plugs Only)	
N	Thread for 1.0 mm Jackscrews	M	1.0 mm Non Captive Jackscrew
Q	Thread for 1.2 mm Jackscrews	N	1.0 mm Captive Jackscrew
		Q	1.2 mm Captive Jackscrew

Conductor Length

XXX Three numbers only, length is in inches (i.e. 012 = twelve inches)
 CXX A "C" followed by two numbers, length is in centimeters (i.e. C06 = six centimeters)
 MXX An "M" followed by two numbers, length is in meters (i.e. M02 = two meters)

Conductor Type

DX	White TEFLON	DM	Color Coded TEFLON per MIL-STD-681
DY	White PTFE M16878/6	DT	White TEFZEL M22759/33
DC	Color Coded TEFLON	GX	TEFLON Ribbon Cable FEP

Conductor Size/Strands

0	28 AWG Solid	3	32 AWG 7 Strand
1	30 AWG Solid	4	34 AWG 7 Strand
2	30 AWG 7 Strand		

DUALOBE Connectors - "Duckbill" Termination

Note: See Page(s) 5026 & 5027 for standard part numbers.

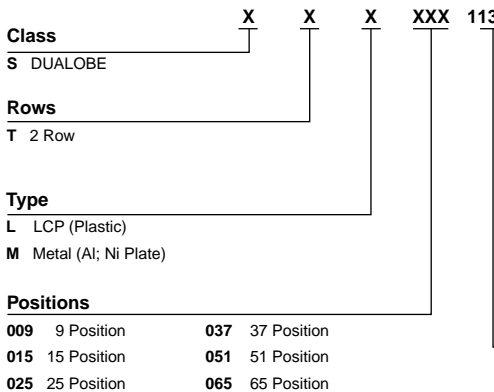

Threads/Jackscrew

Threads (Receptacles Only)		Jackscrews (Plugs Only)	
N	Thread for 1.0 mm Jackscrews	M	1.0 mm Non Captive Jackscrew
Q	Thread for 1.2 mm Jackscrews	N	1.0 mm Captive Jackscrew
		Q	1.2 mm Captive Jackscrew

Configuration

PC	Plug
SC	Receptacle

DUALOBE Connectors - Solder Cup Termination

Note: See Page(s) 5030 & 5031 for standard part numbers.

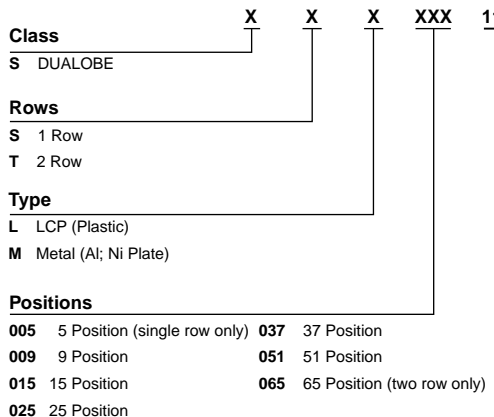

Threads/Jackscrew

Threads (Receptacles Only)		Jackscrews (Plugs Only)	
N	Thread for 1.0 mm Jackscrews	M	1.0 mm Non Captive Jackscrew
Q	Thread for 1.2 mm Jackscrews	N	1.0 mm Captive Jackscrew
		Q	1.2 mm Captive Jackscrew

Configuration

PC	Plug
SC	Receptacle

N-Series Circular Connectors

Circular Nanominiature Connectors .025 [0.64] Pitch

NANONICS N-Series circulars are one of the industry's smallest, reliable, circular nanominiature connectors.

Design and manufacturing focus is aimed directly at:

- High Density
- Reduced Weight
- Reduced Diameter
- High Reliability

This family of in-line circulars is available in pin counts of 7, 19 and 44 positions. Outside diameters range from .300 [7.62] OD. to .530 [13.46] OD.

The connector contact system features burnished gold bores and surfaces through the tubular pins and sockets.

One-piece seamless contacts are used to increase contact area and current carrying capability while reducing effects from vibration, shock and thermal excursions.

NANONICS circular connectors are offered with a wide variety of wire and cable terminations. Leads can be left pigtailed for convenient attachment into pc boards, systems and sensors. Connectors of any type available can be included in the harness design and manufacturing process at Tyco Electronics. Additional panel mounting configurations can be made available.

Specifications

Metal Shell — Aluminum 6061

Plating — Nickel/Gold

Insulator — Liquid crystal polymer

Contacts — Beryllium copper, Nickel over gold plated

Resistance — .003-.008 Ohm

Threaded Coupling Nut Action

Temperature Rated — 482°F [250°C]

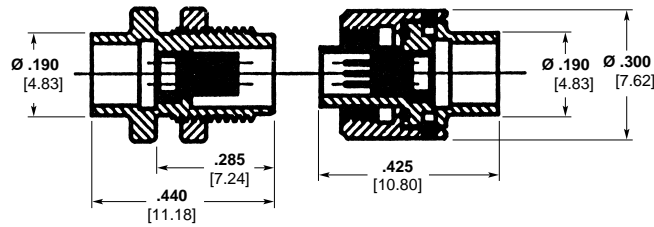
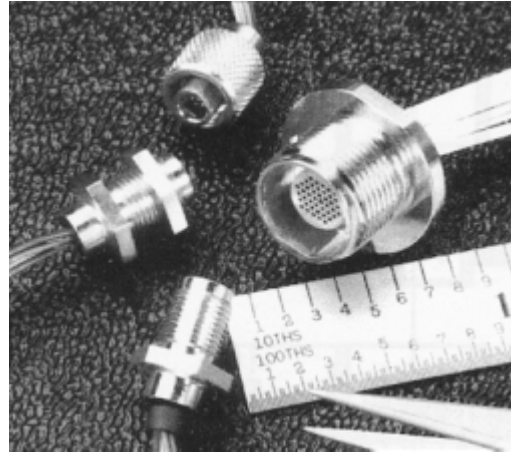

NCG007 — 7 Position Circular

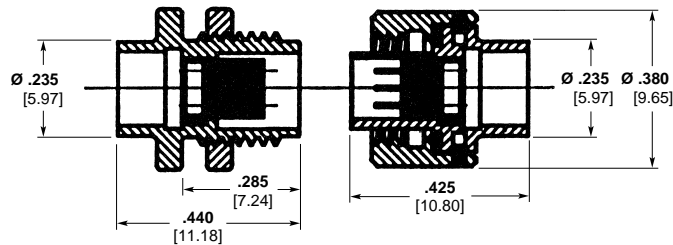

NCG019 — 19 Position Circular

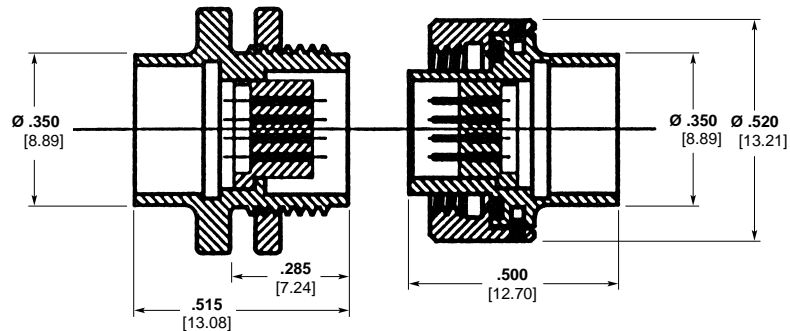

NCG044 — 44 Position Circular

Environmentally Sealed Quick Disconnect Circular Connectors

Nanominiature
.025 [0.64] Contact Pitch

19 Position Quick Disconnect
Flush Mount Receptacle
and Plug

- Environmental seal
- EMI/RFI seal
- Contact system exceeds MIL-C-83513
- Also available in 7 and 44 positions
- "O" rings for environmental seal

Specifications

Connector Body — 6061-T6 Aluminum
Plating — Nickel per MIL-C-26074
Insulator — Liquid crystal polymer
Contact Current — 4 amps continuous
Contact Resistance — .003-.008 Ohm
Contact Mating Force — 1.0 oz. avg./contact
Wire Size — 30 AWG stranded or smaller
Wire Current — 1 amp max. (30 AWG)
Coupling — Push-pull quick disconnect
Mated Length —
 .705 [17.91] (without strain relief)
 1.71 [43.43] (with strain relief sizes 7, 19)
 2.21 [56.13] (with strain relief size 44)

No. of Positions	Receptacle A Dim.	Plug B Dim.
7	.312 7.92	.250 6.35
19	.375 9.53	.300 7.62
44	.500 12.70	.395 10.03

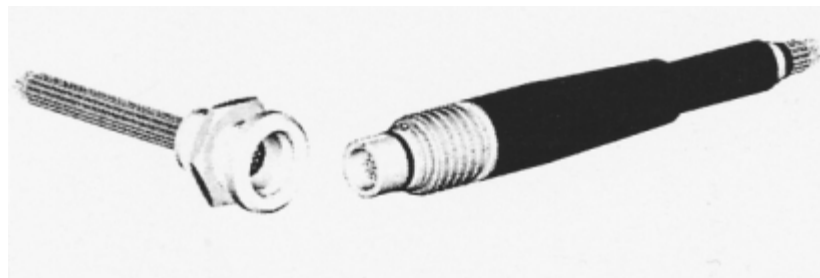

(Shown with Optional Strain Relief)

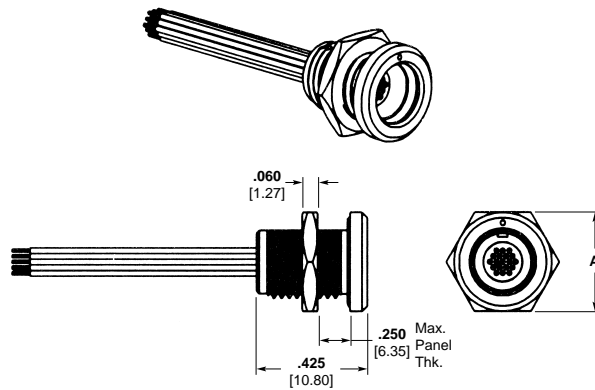

19 Position Flush Mount Receptacle (Shown)

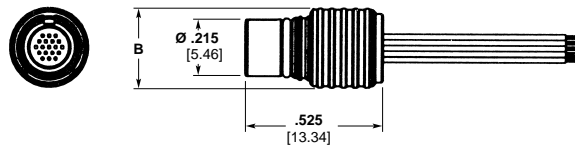
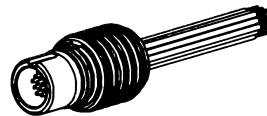

19 Position Plug (Without Strain Relief) (Shown)

5 Pin and Socket Connectors

Environmentally Sealed Threaded Coupling Circular Connectors

Nanominiature
.025 [0.64] Contact Pitch

19 Position Threaded
Coupling Panel Mount
Receptacle and Plug

- Environmental seal
- EMI/RFI seal
- Contact system exceeds MIL-C-83513
- Also available in 7 and 44 positions
- The panel mount receptacle will also mate with the quick disconnect plug

Specifications

Connector Body — 6061-T6 Aluminum
Plating — Nickel per MIL-C-26074
Insulator — Liquid crystal polymer
Contact Current — 4 amps continuous
Contact Resistance — .003-.008 Ohm
Contact Mating Force — 1.0 oz. avg./contact
Wire Size — 30 AWG stranded or smaller
Wire Current — 1 amp max. (30 AWG)
Coupling — Threaded coupling nut
Mated Length —
 .830 [21.08] (without strain relief)
 1.83 [46.48] (with strain relief sizes 7, 19)
 2.33 [59.18] (with strain relief size 44)

No. of Positions	Receptacle	
	Flange A Dim.	Plug B Dim.
7	.406 10.31	.315 8.00
19	.469 11.91	.355 9.02
44	.563 14.30	.475 12.07

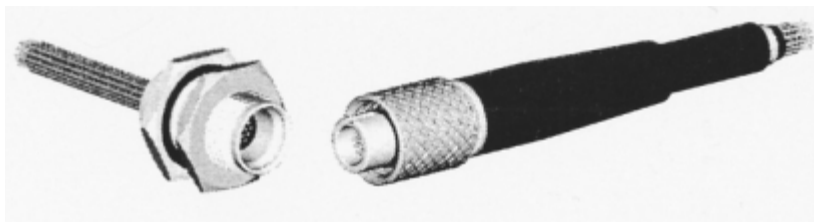

(Shown with Optional Strain Relief)

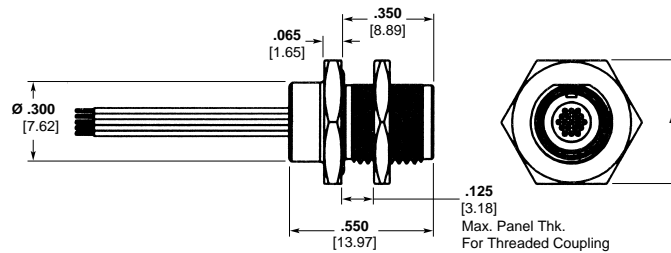
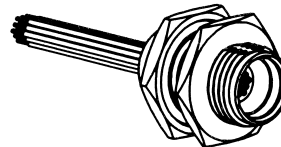

19 Position Panel Mount Receptacle (Shown)

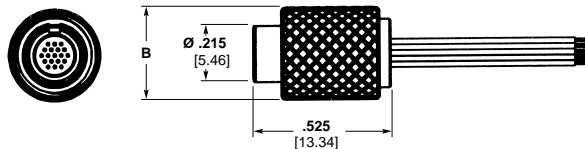
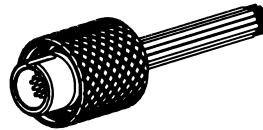

19 Position Plug (Without Strain Relief) (Shown)

Circular Connectors - Wire Terminations

<p>Class/Type</p> <p>NCG NANONICS, Circular, Gold</p> <p>QCM Quick Disconnect, Circular, Metal</p> <p>TCM Threaded Coupling, Circular, Metal (plug only; mates to panel mount receptacle only)</p> <p>Positions</p> <p>007 7 Position</p> <p>019 19 Position</p> <p>044 44 Position</p> <p>Configurations</p> <p>PC Plug</p> <p>SC Receptacle</p> <p>Conductor Size/Strands</p> <p>0 28 AWG Solid 3 32 AWG 7 Strand</p> <p>1 30 AWG Solid 4 34 AWG 7 Strand</p> <p>2 30 AWG 7 Strand</p>	<p>Circular Mounting/Features (Does Not Apply to NCG Series)</p> <table border="0"> <tr> <th colspan="2">Mounting (Receptacles Only)</th> <th>Features</th> </tr> <tr> <td>P</td> <td>Panel Mount</td> <td>B Backshell</td> </tr> <tr> <td>F</td> <td>Flush Mount</td> <td></td> </tr> </table> <p>Conductor Length</p> <p>XXX Three numbers only, length is in inches (i.e. 012 = twelve inches)</p> <p>CXX A "C" followed by two numbers, length is in centimeters (i.e. C06 = six centimeters)</p> <p>MXX An "M" followed by two numbers, length is in meters (i.e. M02 = two meters)</p> <p>Conductor Type</p> <table border="0"> <tr> <td>DX</td> <td>White TEFLON</td> <td>DM</td> <td>Color Coded TEFLON per MIL-STD-681</td> </tr> <tr> <td>DY</td> <td>White PTFE M16878/6</td> <td>DT</td> <td>White TEFZEL M22759/33</td> </tr> <tr> <td>DC</td> <td>Color Coded TEFLON</td> <td></td> <td></td> </tr> </table>	Mounting (Receptacles Only)		Features	P	Panel Mount	B Backshell	F	Flush Mount		DX	White TEFLON	DM	Color Coded TEFLON per MIL-STD-681	DY	White PTFE M16878/6	DT	White TEFZEL M22759/33	DC	Color Coded TEFLON		
Mounting (Receptacles Only)		Features																				
P	Panel Mount	B Backshell																				
F	Flush Mount																					
DX	White TEFLON	DM	Color Coded TEFLON per MIL-STD-681																			
DY	White PTFE M16878/6	DT	White TEFZEL M22759/33																			
DC	Color Coded TEFLON																					

Note: See Page(s) 5023 & 5024 for standard part numbers.

50 Ohm Coaxial Connector System

Options

- Mixed signal option; five signal leads and shell with coax
- Up to 9 coax connections per shell
- Horizontal surface mount receptacle also available

Mechanical Specifications

- Receptacle Contact Outside Diameter — .075 [1.91]
- Mated Contact Pair Length — .322 [8.19]
- Mated Shells Height — .166 [4.22]
- Mated Shells Width — .535 [13.59]
- Mated Shells Length With Back Potting — .511 [12.98]

Product Specifications

- Main Connector** — 6061 Aluminum nickel plated, liquid crystal polymer insulator
- Outer Contact** — Beryllium copper, gold/nickel plated
- Inner Coax Contact** — Beryllium copper, gold/nickel plated
- Coax Insulator** — TEFLON
- Back Potting** — Space quality epoxy
- Wire Size** — 30 AWG to 38 AWG
- Environmental Rating** — Meets MIL-C-83513
- Operating Temperature** — -67°F to 311°F [-55°C to 155°C]
- Electrical Specifications**
- Impedance** — 50 Ohm
- Frequency Range** — 0 - 20 GHz
- Working Voltage** — 100 v
- Dielectric Withstanding** — 300 Vrms @ Sea Level

Note: Insertion Loss of 30 AWG Coax Cable @ (50 Ohm) is approximately 1.0db/ft. @ 3 GHz. The connector system with 6" of coax on each side, is better than 1.5db @ 3 GHz.



Size Comparison: Above; Nano, Below; Micro-D

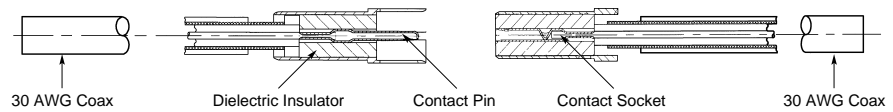

Coax Pin & Socket Contact Set

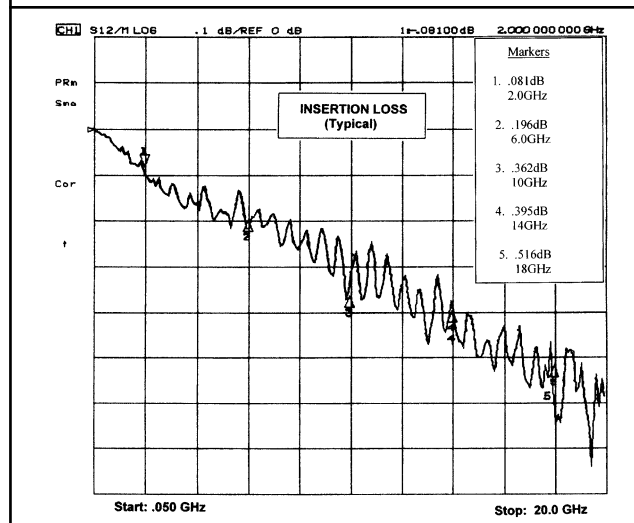
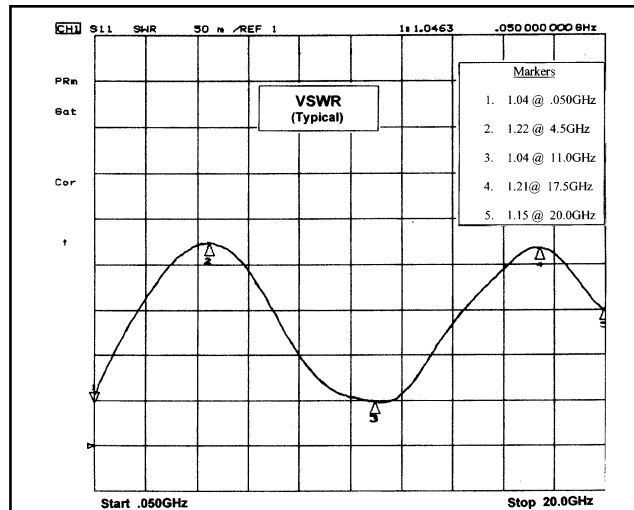

.025 [0.64] Contact Pitch

- Environmentally sealed
- 3000 PSI performance
- RFI/EMI protected
- Vibration and Shock DSCC 94031-94046 MIL-C-83513
- Terminate with wire, flex circuit, and ribbon cable
- Interface with NANONICS standard DUALLOBE connectors

NANONICS nanominiature environmental connectors provide reliability and high density packaging solutions in harsh environmental conditions.

These connectors offer a variety of terminations including one or two rows, plastic or metal shrouds, vertical, horizontal, or panel mount.



Typical

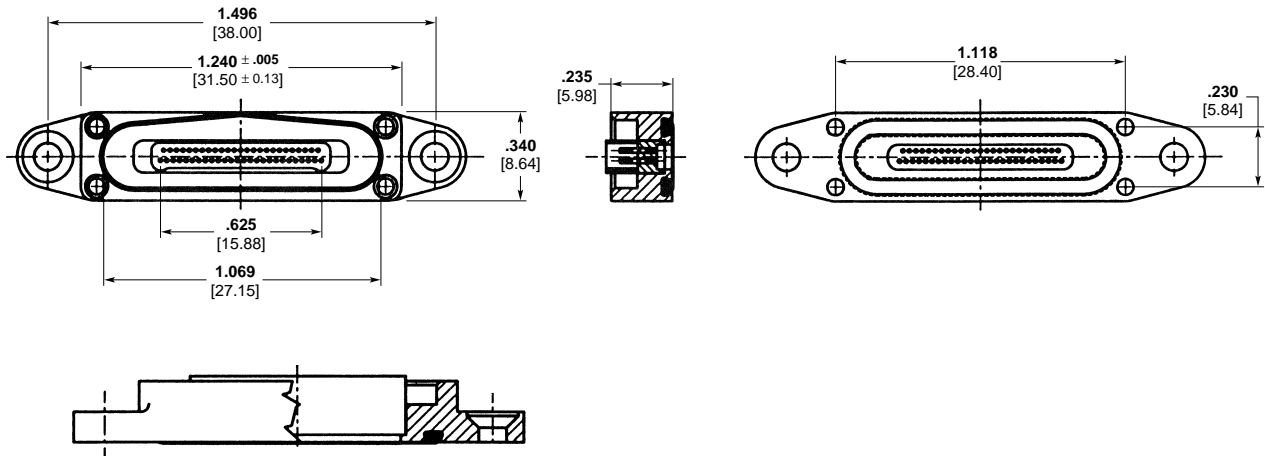

Size 51, 2 Row, DUALLOBE Connectors
Environmental Series,
Receptacle Assembly

For ordering information contact
Tyco Electronics

Catalog 1308940
Revised 5-03

www.tycoelectronics.com

Dimensions are in inches and millimeters unless otherwise specified. Values in brackets are metric equivalents.

Dimensions are shown for reference purposes only. Specifications subject to change.

USA: 1-800-522-6752
Canada: 1-905-470-4425
Mexico: 01-800-733-8926
C. America: 52-55-5-729-0425

South America: 55-11-3611-1514
Hong Kong: 852-2735-1628
Japan: 81-44-844-8013
UK: 44-141-810-8967

Hermetic Connectors

"H Series" Nanominiature
(.025 [0.64] pitch)

- Hermetic per MIL-STD-202
- Meets MIL-STD 833, 1-10-8CC He/s max. leak rate
- Solder/Braze KOVAR bodies
- Laser weldable 4047 aluminum flange
- Seamless spring socket
- One or two contact rows
- Low engaging forces (1.0 oz) minimize stress
- High performance contact system
- Contact Tyco Electronics for detailed information

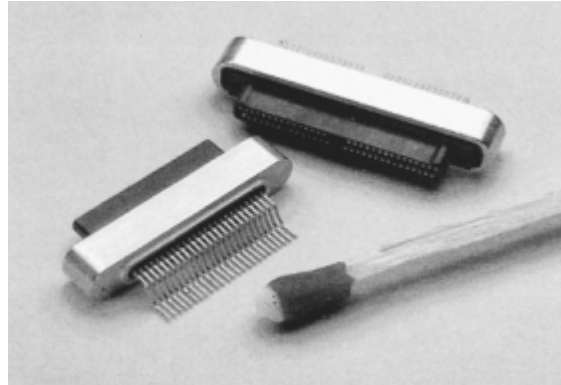

Single Row, 25 Pin

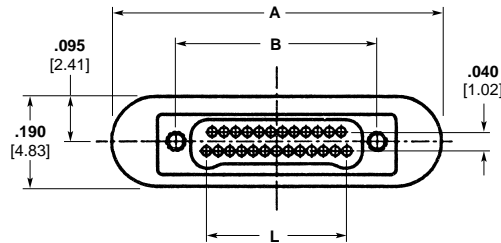

The "H Series" Hermetics bring together established hermetic manufacturing capabilities and our Nanominiature contact and connector design.

The NANONICS "H Series" connectors offer a hermetically glass sealed receptacle per MIL-STD-202 in all sizes. They can be laser welded (aluminum, stainless steel) or soldered/brazed (Kovar). The hermetic receptacles intermate with NANONICS standard line of DUALOBE plugs.

The connectors are designed for MIL class reliability in harsh environments and for dense packaging and reduced size and weight.

Mating DUALOBE plugs offer a variety of terminations and feature one or two rows, plastic or metal shrouds, vertical, horizontal, or panel mount. The contact system features one-piece, seamless, spring socket and gold plated KOVAR pins.

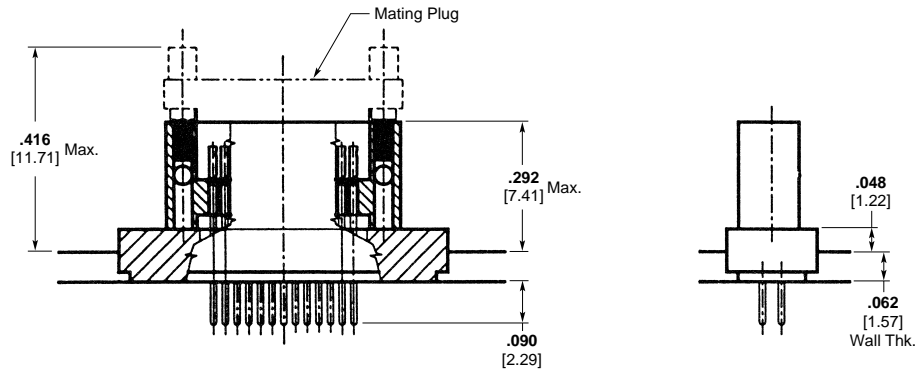

Two Row, Glass Seal, Receptacle

Size	Dimensions		
	A	B	L
9	.500 12.70	.229 5.82	.100 2.54
15	.575 14.61	.304 7.72	.175 4.45
25	.700 17.78	.429 10.90	.300 7.62
37	.850 21.59	.579 14.71	.450 11.43
51*	1.025 26.04	.754 19.15	.625 15.88
65**	1.200 30.48	.929 23.60	.800 20.32

* 46 Contacts, Pos. 12, 13, 14, 38 & 39 are omitted.

** 60 Contacts, Pos. 16, 17, 48, 49 & 50 are omitted.

For ordering information contact
Tyco Electronics

Filtered Connectors

10 MHz - 6+ GHz
 Size 30 Contacts — .025
 [0.64]/.0125 [0.32] Pitch

- EMI/RFI filter options for nanominiature connectors
- 30 microinches of pore-free Goldbore burnished gold on all internal and external contact and crimp surfaces;
 - Low resistance of .003-.008 ohms
 - 4000+ engagement cycles
 - High performance contact system
- Gas-tight mass crimp;
 - termination reliability
 - enables ribbon, flex circuits
- Reliable, seamless contacts
- Temperature, -67°F to 257°F [-55°C to +125°C]
- Increased voltage limits
- Low engaging forces (1.0 oz)
- MIL-C-83513 performance
- Stocked sizes 9, 15, 25, 37, 51 and 65
- Standard sizes available, 5 thru 65 contacts in increments of 1 (1 row) or 2 (2 row)

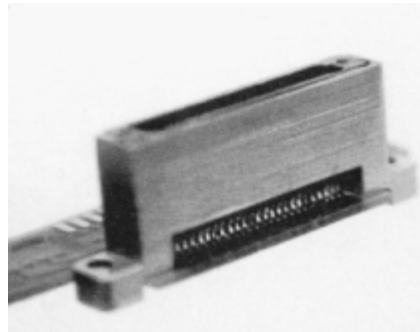

PCB Mount, 51 Position With Filters

Filtered connectors are designed for MIL class, high reliability in harsh environments, and for dense packaging requirements. Small size and weight (0.5 gr avg.) are featured benefits of filtered connectors making them highly suitable for high-density circuit designs. The filter options are available in PI, L, or C configurations and have a range from 10MHz to over 6.0GHz.

PCB connectors with filters (SM or thru-hole) are configured within shrouded DUALOBE connectors versions. Filters are housed within the connector body. The DUALOBE connectors series features one or two rows, with plastic or metal shrouds, vertical, horizontal, or panel mount. Filters may be specified for either plugs or receptacles.

All configurations incorporate an innovative high performance rated contact system on .025 [0.64] centers.

The contact/filter system features a one-piece, seamless, spring socket design that improves connector reliability and performance in harsh environments.

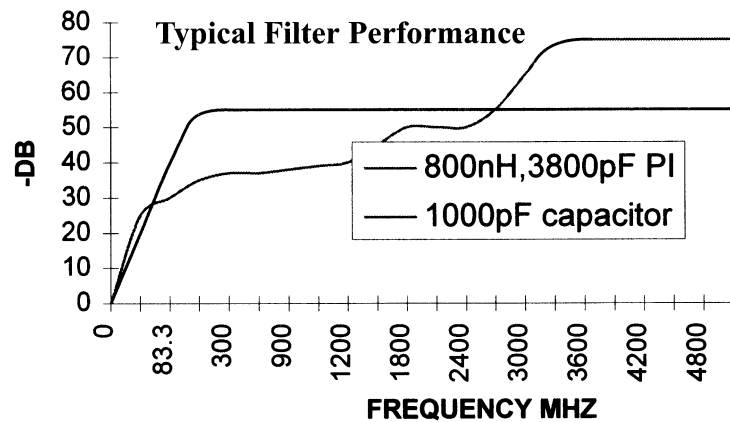

For ordering information contact Tyco Electronics

Flex Circuit, Ribbon Cable Terminations

Proprietary crimp technology helps eliminate solder terminations and related problems

- Mass Crimps exceed requirements of MIL-C-39029 and terminate any material, any shape, any finish, 28 AWG or larger
- Connectors meet DSCC* specifications 94031-94046 for Nanominiature connectors, and the performance requirements of MIL-C-83513
- The contact system features a one-piece, seamless, spring socket and pin design enhancing environmental performance
- New thresholds of performance have been established via the Goldbore contact and proprietary crimp terminations, i.e.:
 - Low resistance of .003-.008 ohms
 - High performance contact system
 - MIL spec quality mass crimp
 - Seamless contacts
 - MIL spec performance
 - DSCC* spec qualified
 - Increased voltage limits via insulator design
 - Low engaging forces
- Stocked sizes: 9, 15, 25, 37, 51 and 65
- Standard sizes: 5-65 positions

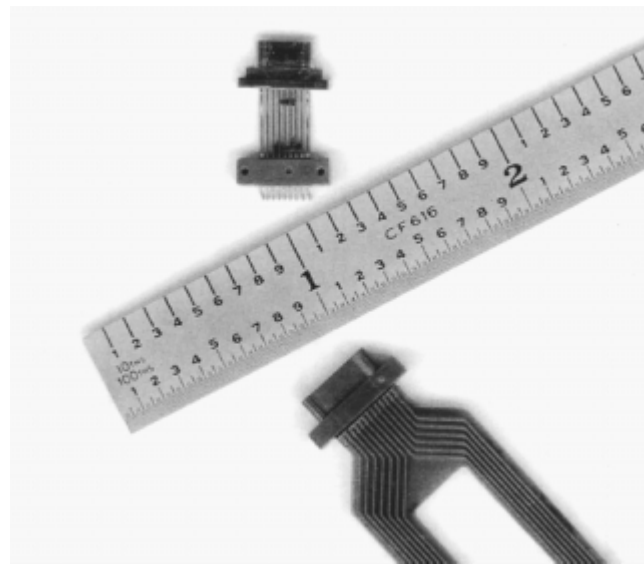

Tyco Electronics offers a wide range of nanominiature connectors for flex circuit and ribbon cable.

Designed for mass crimp termination to .025 [0.64] and .0125 [0.42] pitch flat/ribbon cable and flex circuits, connectors feature

MIL class reliability in harsh environments, and dense packaging capability (1/4 of microminiature size) and reduced weight — 0.5 grams avg.). The 2-row DUALOBE connector provides an effective termination pitch of .0125 [0.42].

Available as strips or shrouded DUALOBE connectors feature one or two rows, vertical, horizontal, surface mount, thru-hole, and panel mount options.

*DSCC-Defense Supply Center, Columbus. Formerly, DESC, Dayton, Ohio

For ordering information contact Tyco Electronics

5020

Catalog 1308940
Revised 5-03

www.tycoelectronics.com

Dimensions are in inches and millimeters unless otherwise specified. Values in brackets are metric equivalents.

Dimensions are shown for reference purposes only. Specifications subject to change.

USA: 1-800-522-6752
Canada: 1-905-470-4425
Mexico: 01-800-733-8926
C. America: 52-55-5-729-0425

South America: 55-11-3611-1514
Hong Kong: 852-2735-1628
Japan: 81-44-844-8013
UK: 44-141-810-8967

Flex Circuit, Ribbon Cable Terminations (Continued)

Crimp to Sculptured Flex Version

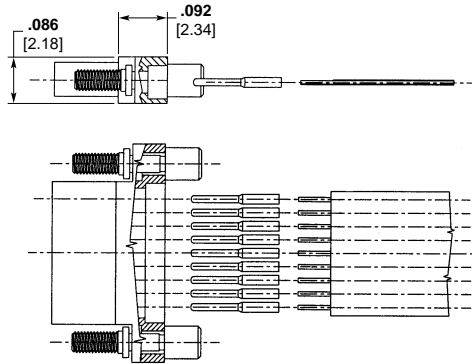

Soldered to Flex

Metal or Plastic, Duckbill Leads, Two Row DUALOBE Connectors

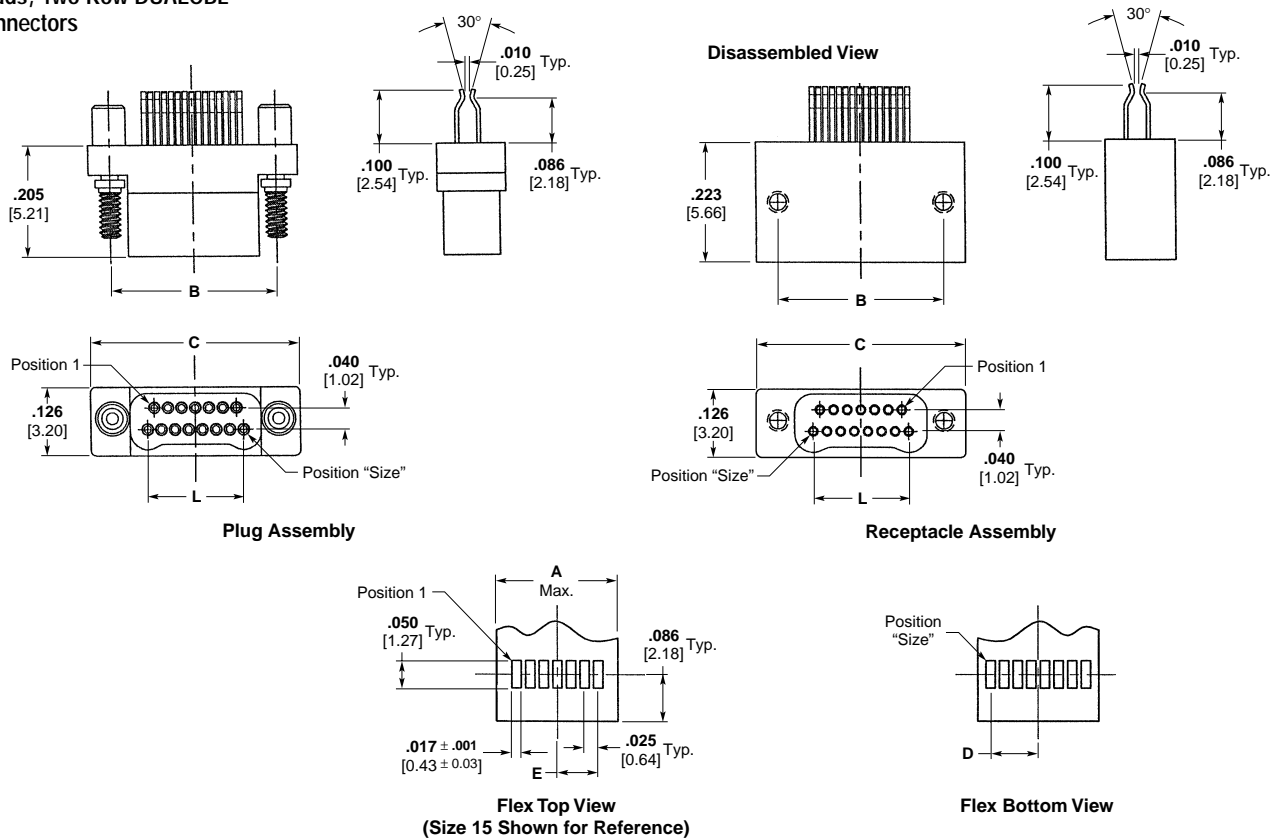

For ordering information contact Tyco Electronics

Size	Dimensions					
	A Max.	B	C ±.0050 [0.13]	D	E	L
09	.150 3.81	.229 5.82	.3085 7.84	.0500 1.27	.0375 0.95	.100 2.54
15	.225 5.72	.304 7.72	.3835 9.74	.0875 2.22	.0750 1.91	.175 4.45
25	.350 8.89	.429 10.90	.5085 12.92	.1500 3.81	.1375 3.49	.300 7.62
37	.500 12.70	.579 14.71	.6585 16.73	.2250 5.72	.2125 5.40	.450 11.43
51	.675 17.15	.754 19.15	.8335 21.17	.3125 7.94	.3000 7.62	.625 15.88
65	.850 21.59	.929 23.60	1.0085 25.62	.4000 10.16	.3875 9.84	.800 20.32

Blindmating Board to Board, or Flex Circuit to Board with Metal DUALOBE Connectors

- Mounted vertically or horizontally
- Surface Mount or Thru-Hole
- Guide pin assisted alignment
- MIL spec quality connectors
- Miniaturization of modules

Formats include horizontal board to horizontal board, and horizontal board to vertical board. Board clamping promotes contact retention, and the connectors act as standoffs to protect the spacing for components between boards.

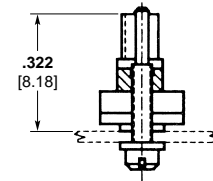
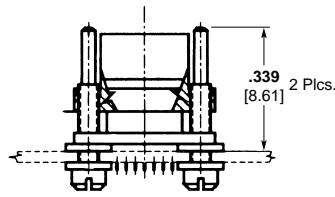
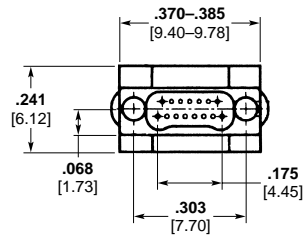

Metal Shell, 2 Row, DUALOBE, 15 Position Plug

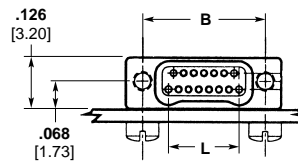
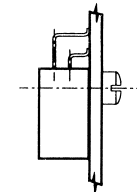
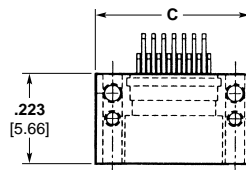

Metal, 2 Row, DUALOBE, Horizontal Surface Mount, Receptacle

Size	Dimensions		
	L	B	C +.010/-0.005 [+.025/-0.13]
9	.100 2.54	.229 5.82	.310 7.87
15	.175 4.45	.304 7.72	.385 9.78
25	.300 7.62	.429 10.90	.510 12.95
37	.450 11.43	.579 14.71	.660 16.76
51	6.25 15.88	.754 19.15	.835 21.21
61	.750 19.05	.879 22.33	.960 24.38
65	.800 20.32	.929 23.60	1.010 25.65

For ordering information contact Tyco Electronics

5022

Catalog 1308940
Revised 5-03

www.tycoelectronics.com

Dimensions are in inches and millimeters unless otherwise specified. Values in brackets are metric equivalents.

Dimensions are shown for reference purposes only. Specifications subject to change.

USA: 1-800-522-6752
Canada: 1-905-470-4425
Mexico: 01-800-733-8926
C. America: 52-55-5-729-0425

South America: 55-11-3611-1514
Hong Kong: 852-2735-1628
Japan: 81-44-844-8013
UK: 44-141-810-8967

NANONICS Part Number	Tyco Part Number
Coax Only	
CX010PC2RG006N	0-1589070-1
CX010PC2RG018N	0-1589070-2
CX010PC2RG072N	0-1589070-3
CX020PC2RG018N	0-1589070-4
CX030PC2RG006N	0-1589070-5
CX030PC2RG012	0-1589070-6
CX030PC2RG012N	0-1589070-7
CX030PC2RG018N	0-1589070-8
CX030PC2RG020Q	0-1589070-9
CX030SC2RG006N	0-1589071-3
CX030SC2RG012	0-1589071-4
CX040PC2RG012N	1-1589070-0
CX040PC2RG030N	1-1589070-1
CX040SC2RG012	0-1589071-5
Coaxial - Horizontal Surface Mount	
CX010L2HN	0-1589072-1
CX030L2HN	0-1589072-3
CX030L23N	0-1589072-2
CX03511822L2HN	0-1589075-1
CX04511822L2HN	0-1589075-2
Coax with Mixed Signals	
CX015PC2RC012	0-1589068-1
CX015SC2RC012N	0-1589069-1
CX035PC2RC006N	0-1589068-2
CX035PC2RC018N	0-1589068-3
CX035SC2RC006N	0-1589069-2
CX035SC2RC018N	0-1589069-3
CX045PC2RC006N	0-1589068-4
CX045SC2RC006N	0-1589069-4
Circular Connectors	
NCG007PC2DC003	0-1589425-1
NCG007PC2DC006	0-1589425-2
NCG007PC2DC008	0-1589425-3
NCG007PC2DC012	0-1589425-4
NCG007PC2DC018	0-1589425-5
NCG007PC2DC040	0-1589425-6
NCG007PC2DCC60	0-1589425-7
NCG007PC2DM024	0-1589425-8
NCG007SC2DC003	0-1589426-1
NCG007SC2DC004	0-1589426-2
NCG007SC2DC006	0-1589426-3
NCG007SC2DC008	0-1589426-4
NCG007SC2DC012	0-1589426-5
NCG007SC2DC018	0-1589426-6
NCG007SC2DC024	0-1589426-7
NCG007SC2DC036	0-1589426-8
NCG007SC2DC048	0-1589426-9
NCG007SC2DC060	1-1589426-0
NCG007SC2DM024	1-1589426-1
NCG019PC2DC003	0-1589427-1
NCG019PC2DC006	0-1589427-2
NCG019PC2DC018	0-1589427-3
NCG019PC2DC036	0-1589427-4
NCG019PC2DC072	0-1589427-5
NCG019PC3DC036	0-1589427-6
NCG019SC2DC003	0-1589428-1
NCG019SC2DC006	0-1589428-2
NCG019SC2DC018	0-1589428-3
NCG019SC2DC024	0-1589428-4
NCG019SC2DC036	0-1589428-5

NANONICS Part Number	Tyco Part Number
NCG019SC2DC072	0-1589428-6
NCG019SC3DC036	0-1589428-7
NCG044PC2DC003	0-1589429-1
NCG044PC2DC006	0-1589429-2
NCG044PC2DC012	0-1589429-3
NCG044PC2DC015	0-1589429-4
NCG044PC2DC033	0-1589429-5
NCG044PC2DC036	0-1589429-6
NCG044PC2DC042	0-1589429-7
NCG044PC2DC060	0-1589429-8
NCG044PC2DCC30	0-1589429-9
NCG044SC2DC003	0-1589430-1
NCG044SC2DC006	0-1589430-2
NCG044SC2DC012	0-1589430-3
NCG044SC2DC015	0-1589430-4
NCG044SC2DC018	0-1589430-5
NCG044SC2DC024	0-1589430-6
NCG044SC2DC036	0-1589430-7
NCG044SC2DC060	0-1589430-8
NCG044SC2DCC30	0-1589430-9
QCM007PC2DC003	0-1589055-1
QCM007PC2DC006	0-1589055-2
QCM007PC2DC012	0-1589055-3
QCM007PC2DC012B	0-1589055-4
QCM007PC2DC018B	0-1589055-5
QCM007PC2DC020	0-1589055-6
QCM007PC2DC036B	0-1589055-7
QCM007PC2DC040	0-1589055-8
QCM007PC2DC072	0-1589055-9
QCM007PC2DCC30	1-1589055-0
QCM007PC2DMC46	1-1589055-1
QCM007PC2DX006B	1-1589055-2
QCM007SC2DC003P	0-1589060-1
QCM007SC2DC004P	0-1589060-2
QCM007SC2DC006F	0-1589056-1
QCM007SC2DC006P	0-1589060-3
QCM007SC2DC012P	0-1589060-4
QCM007SC2DC012PB	0-1589060-5
QCM007SC2DC018PB	0-1589060-6
QCM007SC2DC020F	0-1589056-2
QCM007SC2DC036P	0-1589060-7
QCM007SC2DC036PB	0-1589060-8
QCM007SC2DCC30F	0-1589056-3
QCM007SC2DCC30P	0-1589060-9
QCM007SC2DM003P	1-1589060-0
QCM007SC2DMC16F	0-1589056-4
QCM007SC2DMC46F	0-1589056-5
QCM007SC2DX006F	0-1589056-6
QCM019PC0DC012	0-1589057-1
QCM019PC0DM072B	0-1589057-2
QCM019PC2DC003	0-1589057-3
QCM019PC2DC006	0-1589057-4
QCM019PC2DC012	0-1589057-5
QCM019PC2DC020	0-1589057-6
QCM019PC2DC120B	0-1589057-7
QCM019PC2DMC46	0-1589057-8
QCM019PC2DXC30	0-1589057-9
QCM019SC0DC012F	0-1589058-1
QCM019SC0DCC15P	0-1589061-1
QCM019SC0DM072F	0-1589058-2
QCM019SC0DXC15P	0-1589061-2

NANONICS Part Number	Tyco Part Number
QCM019SC2DC003P	0-1589061-3
QCM019SC2DC006F	0-1589058-3
QCM019SC2DC006P	0-1589061-4
QCM019SC2DC012P	0-1589061-5
QCM019SC2DC018F	0-1589058-4
QCM019SC2DC020F	0-1589058-5
QCM019SC2DC020P	0-1589061-6
QCM019SC2DC036P	0-1589061-7
QCM019SC2DCC30P	0-1589061-8
QCM019SC2DMC16F	0-1589058-6
QCM019SC2DMC46F	0-1589058-7
QCM019SC2DXC30F	0-1589058-8
QCM019SC2DXC30P	0-1589061-9
QCM044PC2DC003	0-1589059-1
QCM044PC2DC006	0-1589059-2
QCM044PC2DC006B	0-1589059-3
QCM044PC2DC012	0-1589059-4
QCM044PC2DC012B	0-1589059-5
QCM044PC2DC020	0-1589059-6
QCM044PC2DC030	0-1589059-7
QCM044PC2DC060B	0-1589059-8
QCM044PC2DC120B	0-1589059-9
QCM044SC2DC003P	0-1589062-1
QCM044SC2DC006F	0-1589058-9
QCM044SC2DC006P	0-1589062-2
QCM044SC2DC012F	1-1589058-0
QCM044SC2DC012P	0-1589062-3
QCM044SC2DC018F	1-1589058-1
QCM044SC2DC019PB	0-1589062-4
QCM044SC2DC020F	1-1589058-2
QCM044SC2DC036P	0-1589062-5
QCM044SC2DC060F	1-1589058-3
QCM044SC2DMC16P	0-1589062-6
QCM044SC2DMC46P	0-1589062-7
TCM007PC2DC003	0-1589063-1
TCM007PC2DC006	0-1589063-2
TCM007PC2DC006B	0-1589063-3
TCM007PC2DC012	0-1589063-4
TCM007PC2DC012B	0-1589063-5
TCM007PC2DC018B	0-1589063-6
TCM007PC2DC036	0-1589063-7
TCM007PC2DM003	0-1589063-8
TCM019PC0DCC10	0-1589064-1
TCM019PC0DXC10	0-1589064-2
TCM019PC2DC003	0-1589064-3
TCM019PC2DC006	0-1589064-4
TCM019PC2DC006B	0-1589064-5
TCM019PC2DC012	0-1589064-6
TCM019PC2DC012B	0-1589064-7
TCM019PC2DC024	0-1589064-8
TCM019PC2DC036	0-1589064-9
TCM019PC2DC060B	1-1589064-0
TCM019PC2DC066	1-1589064-1
TCM019PC2DCC30	1-1589064-2
TCM044PC2DC003	0-1589065-1
TCM044PC2DC006	0-1589065-2
TCM044PC2DC006B	0-1589065-3
TCM044PC2DC012	0-1589065-4
TCM044PC2DC012B	0-1589065-5
TCM044PC2DC018B	0-1589065-6
TCM044PC2DC019B	0-1589065-7

NANONICS Part Number	Tyco Part Number	NANONICS Part Number	Tyco Part Number	NANONICS Part Number	Tyco Part Number
TCM044PC2DC036	0-1589065-8	JSM051PP2GXC50N	5-1589672-8	JTM025PR2DT240N	3-1589674-9
TCM044PC2DC036B	0-1589065-9	JSM051PP2GXC75N	5-1589672-9	JTM025PR2DX0.5N	4-1589674-0
TCM044PC2DMC46	1-1589065-0	JSM051PP2GXC80N	6-1589672-0	JTM025PR2DX006Q	4-1589674-1
DUALOBE Jumpers					
JSL009PP2DX003N	7-1589671-1	JSM051PR2GX002N	6-1589672-1	JTM025PR2DX012N	4-1589674-2
JSL009PR2DC012N	7-1589671-2	JTL015PP2DX008M	9-1589672-5	JTM025PR2DX020	4-1589674-3
JSL009RR2DX0.5N	7-1589671-3	JTL015PR2DX008	9-1589672-6	JTM037PD2DC002N	8-1589674-8
JSL015PP2DX006N	7-1589671-4	JTL025PP2DCC036N	9-1589672-8	JTM037PD2DC004N	8-1589674-9
JSL037PD2GXC02N	7-1589671-5	JTL025PP2DCC07N	9-1589672-9	JTM037PD2GX012N	9-1589674-0
JSL037PR2DX002N	7-1589671-6	JTL025PP2DX002N	0-1589673-1	JTM037PD2GX024N	9-1589674-1
JSL051PD2GXC10N	7-1589671-7	JTL025PP2DX003N	0-1589673-2	JTM037PP0DM006	9-1589674-2
JSL051PD2GXC17N	7-1589671-8	JTL025PP2DX010N	0-1589673-3	JTM037PP2DX001N	9-1589674-4
JSL051PD2GXC22N	7-1589671-9	JTL025PR2DCM31N	0-1589673-4	JTM037PP2DX002N	9-1589674-5
JSL051PD2GXC30N	8-1589671-0	JTL037PP2DCC07.5N	0-1589673-5	JTM037PP2DX004N	9-1589674-6
JSL051PD2GXC75N	8-1589671-1	JTL037PP2DCC08.5N	0-1589673-6	JTM037PP2DX006Q	9-1589674-7
JSL051PD2GXC80N	8-1589671-2	JTL037PP2DCC09.5N	0-1589673-7	JTM037PP2DX009Q	9-1589674-8
JSL051PP2DC004N	8-1589671-3	JTL037PP2DX002N	0-1589673-8	JTM037PP2DX016	9-1589674-9
JSL051PP2GXC10N	8-1589671-4	JTL037PP2DX003N	0-1589673-9	JTM037PP2DX024N	0-1589675-1
JSL051PP2GXC15N	8-1589671-5	JTL037PP2DX012	1-1589673-0	JTM037PP2GX024N	0-1589675-2
JSL051PP2GXC17N	8-1589671-6	JTL037PR2DT024N	1-1589673-1	JTM037PR0DC036M	0-1589675-3
JSL051PP2GXC22N	8-1589671-7	JTL051PP2DX002N	1-1589673-4	JTM037PR2DT001N	0-1589675-4
JSL051PP2GXC75N	8-1589671-8	JTL051PP2DX006N	1-1589673-5	JTM037PR2DX001N	0-1589675-5
JSL051PP2GXC80N	8-1589671-9	JTL051PP2DX010N	1-1589673-6	JTM037PR2GX002	0-1589675-6
JSM005PP2DC002N	9-1589671-0	JTL051PP2DX024N	1-1589673-7	JTM037PR2GX003N	0-1589675-7
JSM005PP2DT150N	9-1589671-1	JTL051PR2DC048	1-1589673-8	JTM051PD2DT004N	6-1589675-1
JSM009PP2DC002N	9-1589671-5	JTL065PP2DC012N	2-1589673-3	JTM051PD2DXC10N	6-1589675-2
JSM009PP2DC003N	9-1589671-6	JTL065PP2DCC05N	2-1589673-4	JTM051PP2DC004N	6-1589675-3
JSM009PP2DC024N	9-1589671-7	JTM009PD2DX003N	3-1589673-1	JTM051PP2DX001N	6-1589675-4
JSM009PR2DC002N	9-1589671-8	JTM009PD2DX006N	3-1589673-2	JTM051PP2DX004N	6-1589675-5
JSM009PR2DC006N	9-1589671-9	JTM009PP2DC02.5N	3-1589673-3	JTM051PP2DX012N	6-1589675-6
JSM015PD2DCC02N	0-1589672-6	JTM009PP2DT002N	3-1589673-4	JTM051PP2DX2.5N	6-1589675-7
JSM015PP2GX014N	0-1589672-7	JTM009PP2DT004N	3-1589673-5	JTM051PP2DX4.5N	6-1589675-8
JSM015PP2GX018N	0-1589672-8	JTM009PP2DX006N	3-1589673-6	JTM051PR2DC002N	6-1589675-9
JSM015PR2DC001N	0-1589672-9	JTM009PR2DCC50N	3-1589673-7	JTM051PR2DC005	7-1589675-0
JSM015PR2DC002N	1-1589672-0	JTM015PD2GX012N	6-1589673-8	JTM051PR2DT001N	7-1589675-1
JSM015PR2DC003N	1-1589672-1	JTM015PP2DC006M	6-1589673-5	JTM051PR2DX002N	7-1589675-2
JSM015PR2DC006N	1-1589672-2	JTM015PP2DC012M	6-1589673-6	JTM051PR2GX002	7-1589675-3
JSM025PP2DX004N	2-1589672-0	JTM015PP2DC02.5N	6-1589673-7	JTM051PR2GX006Q	7-1589675-4
JSM025PP2DX008N	2-1589672-1	JTM015PP2DT004N	6-1589673-8	JTM051RR2DC003	7-1589675-5
JSM025PP2DXC17N	2-1589672-2	JTM015PP2DX001N	6-1589673-9	JTM065PP2DX002N	0-1589676-1
JSM025PP2GX003N	2-1589672-3	JTM015PP2DX006N	7-1589673-0	JTM065PP2DX004N	0-1589676-2
JSM025PP2GX024N	2-1589672-4	JTM015PP2DX009N	7-1589673-1	JTM065PP2DX006N	0-1589676-3
JSM025PP4DXC20N	2-1589672-5	JTM015PP2DX024N	7-1589673-2	JTM065PP2DX007N	0-1589676-4
JSM025PR2DC006N	2-1589672-6	JTM015PP2GX003	7-1589673-3	JTM065PR2DC001N	0-1589676-5
JSM025PR2GX002N	2-1589672-7	JTM015PP2GX006	7-1589673-4	JTM065PR2DC003	0-1589676-6
JSM037PD2GXC10N	3-1589672-3	JTM015PP2GX012	7-1589673-5	JTM065PR2DC003N	0-1589676-7
JSM037PP2DCC06Q	3-1589672-4	JTM015PP2GX012N	7-1589673-6	JTM065PR2DX004N	0-1589676-8
JSM037PP2DCC08Q	3-1589672-5	JTM015PP2GX024	7-1589673-7	JTM065PR2GX001N	0-1589676-9
JSM037PP2DX018N	3-1589672-6	JTM015PR2DC002N	7-1589673-8	JTM065RR2DC003	1-1589676-0
JSM037PP2GX072N	3-1589672-7	JTM015PR2DC012M	7-1589673-9	DUALOBE - Surface Mount & Thru Hole	
JSM051PD2GXC10N	4-1589672-7	JTM015PR2DT001N	8-1589673-0	SSL005L2AN	0-1589462-5
JSM051PD2GXC12	4-1589672-8	JTM025PP2DX001N	2-1589674-8	SSL005L2HN	0-1589462-6
JSM051PD2GXC12N	4-1589672-9	JTM025PP2DX012N	2-1589674-9	SSL005M6SN	0-1589469-6
JSM051PD2GXC15N	5-1589672-0	JTM025PP2DX018N	3-1589674-0	SSL009L2AN	0-1589462-7
JSM051PD2GXC17N	5-1589672-1	JTM025PP2DX022N	3-1589674-1	SSL009L2AQ	0-1589462-8
JSM051PD2GXC50N	5-1589672-2	JTM025PP2DX03.8M	3-1589674-2	SSL009L2HN	0-1589462-9
JSM051PP2DCC12Q	5-1589672-3	JTM025PP2DX03.8N	3-1589674-3	SSL009L42HN	0-1589463-1
JSM051PP2GXC12	5-1589672-4	JTM025PP2DY006N	3-1589674-4	SSL009L43KN	0-1589464-1
JSM051PP2GXC12N	5-1589672-5	JTM025PP2DY020N	3-1589674-5	SSL009L4CN	0-1589463-2
JSM051PP2GXC17N	5-1589672-6	JTM025PR0DXC20N	3-1589674-6	SSL009L4KN	0-1589463-3
JSM051PP2GXC22N	5-1589672-7	JTM025PR0DXC30N	3-1589674-7	SSL009M6D	0-1589469-7
		JTM025PR2DT001N	3-1589674-8	SSL009M6H	0-1589469-8

NANONICS Part Number	Tyco Part Number	NANONICS Part Number	Tyco Part Number	NANONICS Part Number	Tyco Part Number
SSL009M6SN	0-1589469-9	SSM025M5CN	1-1589470-0	STL025C6N	0-1589481-1
SSL015L2AN	1-1589462-0	SSM025M5HN	1-1589470-1	STL025L2AN	1-1589483-5
SSL015L2AQ	1-1589462-1	SSM025M5LQ	1-1589470-2	STL025L2AQ	1-1589483-6
SSL015L2CN	1-1589462-2	SSM025M6DQ	2-1589469-7	STL025L2HN	1-1589483-7
SSL015L2H	1-1589462-3	SSM025M6HN	2-1589469-8	STL025L42KN	1-1589484-1
SSL015L2HNN	1-1589462-4	SSM025M6SN	3-1589469-0	STL025L44N	1-1589484-2
SSL015L4N	0-1589463-4	SSM031L2AN	7-1589679-2	STL025L4HN	1-1589484-3
SSL015M5KN	0-1589470-2	SSM031L2HN	7-1589679-3	STL025L4KN	1-1589484-4
SSL015M6D	1-1589469-0	SSM037B2	0-1589460-9	STL025M5	1-1589488-0
SSL015M6N	1-1589469-1	SSM037B2N	1-1589460-2	STL025M5CN	1-1589488-1
SSL025B2	0-1589460-1	SSM037L2AQ	3-1589462-9	STL025M6	0-1589487-9
SSL025L2AN	1-1589462-6	SSM037L2HN	4-1589462-1	STL025M6DQ	1-1589487-0
SSL025L2HN	1-1589462-7	SSM037L42KN	1-1589463-9	STL025M6N	1-1589487-1
SSL025L42	0-1589463-5	SSM037L4KN	2-1589463-0	STL025M6SN	1-1589487-2
SSL025M5CN	0-1589470-3	SSM037L84KN	0-1589467-1	STL037B42	0-1589485-2
SSL025M6D	1-1589469-2	SSM037M6HN	3-1589469-2	STL037L2AN	2-1589483-0
SSL025M6DQ	1-1589469-3	SSM037M6SN	3-1589469-3	STL037L2AQ	2-1589483-1
SSL025M6H	1-1589469-4	SSM051C5N	0-1589461-3	STL037L2HN	2-1589483-2
SSL025M6HN	1-1589469-5	SSM051L2AQ	4-1589462-3	STL037L44KN	1-1589484-5
SSL025M6SQ	1-1589469-6	SSM051L2HN	4-1589462-4	STL037L4HN	1-1589484-6
SSL037B2N	0-1589460-4	SSM051L2IQ	4-1589462-5	STL037M5LQ	1-1589488-3
SSL037L2HN	1-1589462-8	SSM051L42KN	2-1589463-1	STL037M5Q	1-1589488-4
SSL037M5N	0-1589470-4	SSM051L44KN	2-1589463-2	STL037M6SN	1-1589487-5
SSL051B2	0-1589460-5	SSM051L4KN	2-1589463-3	STL051L2AQ	2-1589483-4
SSL051L2CN	1-1589462-9	SSM051M5CN	1-1589470-3	STL051L2CN	2-1589483-5
SSL051L2HN	2-1589462-0	SSM051M6SN	3-1589469-4	STL051L2HN	2-1589483-6
SSM005L2HN	2-1589462-1	STL009L2H	0-1589483-8	STL051L42KN	1-1589484-7
SSM005M6SN	1-1589469-7	STL009L2HN	0-1589483-9	STL051L4HN	1-1589484-8
SSM009B2N	0-1589460-7	STL009L42KN	0-1589484-2	STL051L4KN	1-1589484-9
SSM009C5Q	0-1589461-1	STL009L4KN	0-1589484-3	STL051M5CN	1-1589488-5
SSM009C6Q	0-1589471-1	STL009M5L	0-1589488-7	STL051M6A	1-1589487-6
SSM009L2	2-1589462-2	STL015B2N	0-1589490-1	STL051M6SN	1-1589487-7
SSM009L2AN	2-1589462-3	STL015B44N	0-1589485-1	STL065L2HN	2-1589483-7
SSM009L2AQ	2-1589462-4	STL015L2AN	1-1589483-1	STL065L2N	2-1589483-8
SSM009L2HN	2-1589462-5	STL015L2AQ	1-1589483-2	STL065L42KN	2-1589484-0
SSM009L2N	2-1589462-6	STL015L2CN	1-1589483-3	STL065L44N	2-1589484-1
SSM009L2SN	2-1589462-7	STL015L2HN	1-1589483-4	STL065L4CQ	2-1589484-2
SSM009L42KN	0-1589463-6	STL015L42KN	0-1589484-5	STL065L4KN	2-1589484-3
SSM009L44KN	0-1589463-7	STL015L44KN	0-1589484-6	STL065M6SN	1-1589487-8
SSM009L44N	0-1589463-8	STL015L44N	0-1589484-7	STM009B42N	0-1589485-3
SSM009L4KN	0-1589463-9	STL015L4CQ	0-1589484-8	STM009C6N	0-1589481-2
SSM009M5CN	0-1589470-5	STL015L4HN	0-1589484-9	STM009L2HN	3-1589483-0
SSM009M5HN	0-1589470-6	STL015L4KN	1-1589484-0	STM009L2N	3-1589483-1
SSM009M5LQ	0-1589470-7	STL015M5CN	0-1589488-8	STM009L2SN	3-1589483-2
SSM009M6AQ	1-1589469-8	STL015M6CN	0-1589487-6	STM009L42HN	2-1589484-4
SSM009M6CN	1-1589469-9	STL015M6SN	0-1589487-7	STM009L42KN	2-1589484-5
SSM009M6DQ	2-1589469-0	SSM015C5N	0-1589461-2	STM009L44HN	2-1589484-6
SSM009M6HN	2-1589469-2	SSM015L2AN	2-1589462-8	STM009L44PQ	2-1589484-7
SSM009M6SN	2-1589469-4	SSM015L2AQ	2-1589462-9	STM009L44Q	2-1589484-8
SSM025B44N	0-1589465-1	SSM015L2CN	3-1589462-0	STM009L4AQ	2-1589484-9
SSM025C6Q	0-1589471-2	SSM015L2HN	3-1589462-1	STM009L4KN	3-1589484-0
SSM025L2AN	3-1589462-4	SSM015L2SN	3-1589462-2	STM009L4PQ	3-1589484-1
SSM025L2AQ	3-1589462-5	SSM015L44KN	1-1589463-0	STM009M5CN	1-1589488-6
SSM025L2HN	3-1589462-6	SSM015L4KN	1-1589463-1	STM009M5DQ	1-1589488-7
SSM025L2SN	3-1589462-8	SSM015L4PQ	1-1589463-2	STM009M5HN	1-1589488-8
SSM025L44HN	1-1589463-3	SSM015M5CN	0-1589470-8	STM009M5LQ	1-1589488-9
SSM025L44KN	1-1589463-4	SSM015M5LQ	0-1589470-9	STM009M5Q	2-1589488-0
SSM025L4HN	1-1589463-5	SSM015M6HN	2-1589469-5	STM009M6AN	1-1589487-9
SSM025L4KN	1-1589463-6	SSM015M6SN	2-1589469-6	STM009M6DQ	2-1589487-0
SSM025L4PQ	1-1589463-7	STL025B2	0-1589490-2	STM009M6HN	2-1589487-1
SSM025L4SN	1-1589463-8	STL025C5N	0-1589482-1	STM009M6SN	2-1589487-2

NANONICS Part Number	Tyco Part Number	NANONICS Part Number	Tyco Part Number	NANONICS Part Number	Tyco Part Number
STM015B2N	0-1589490-3	STM025M5SN	3-1589488-2	STM051M5AQ	3-1589488-9
STM015B42N	0-1589485-4	STM025M6AN	2-1589487-9	STM051M5CN	4-1589488-0
STM015C6N	0-1589481-3	STM025M6CN	3-1589487-0	STM051M5DQ	4-1589488-1
STM015L2AQ	3-1589483-5	STM025M6DQ	3-1589487-1	STM051M5LQ	4-1589488-2
STM015L2HN	3-1589483-6	STM025M6HN	3-1589487-2	STM051M5PQ	4-1589488-3
STM015L2HQ	3-1589483-7	STM025M6N	3-1589487-3	STM051M6CN	4-1589487-3
STM015L2LQ	3-1589483-8	STM025M6Q	3-1589487-4	STM051M6DQ	4-1589487-4
STM015L2N	3-1589483-9	STM025M6SN	3-1589487-5	STM051M6HN	4-1589487-5
STM015L2SN	4-1589483-0	STM037B2N	0-1589490-5	STM051M6PQ	4-1589487-6
STM015L42KN	3-1589484-2	STM037B42N	0-1589485-8	STM051M6SN	4-1589487-7
STM015L44AQ	3-1589484-3	STM037B4N	0-1589485-9	STM051M6SQ	4-1589487-8
STM015L44HN	3-1589484-4	STM037C6N	0-1589481-5	STM065B2Q	0-1589490-9
STM015L44KN	3-1589484-5	STM037L2AN	5-1589483-3	STM065B42N	1-1589485-1
STM015L44Q	3-1589484-6	STM037L2AQ	5-1589483-4	STM065B44	1-1589485-2
STM015L4HN	3-1589484-7	STM037L2HN	5-1589483-5	STM065B44Q	1-1589485-3
STM015L4KN	3-1589484-8	STM037L2SN	5-1589483-7	STM065B4Q	1-1589485-4
STM015L4PQ	3-1589484-9	STM037L42HN	5-1589484-2	STM065C5Q	0-1589482-5
STM015L82HN	0-1589486-1	STM037L42K	5-1589484-3	STM065C6	0-1589481-7
STM015L84KN	0-1589486-2	STM037L42KN	5-1589484-4	STM065L2AQ	7-1589483-1
STM015M5AN	2-1589488-1	STM037L44KN	5-1589484-5	STM065L2CN	7-1589483-2
STM015M5CN	2-1589488-2	STM037L44PQ	5-1589484-6	STM065L2HN	7-1589483-3
STM015M5HN	2-1589488-3	STM037L44Q	5-1589484-7	STM065L2KN	7-1589483-5
STM015M5KN	2-1589488-4	STM037L44SN	5-1589484-8	STM065L42HN	7-1589484-2
STM015M5LN	2-1589488-5	STM037L4HN	5-1589484-9	STM065L42KN	7-1589484-3
STM015M5LQ	2-1589488-6	STM037L4KN	6-1589484-0	STM065L42N	7-1589484-4
STM015M5PQ	2-1589488-7	STM037L4PQ	6-1589484-1	STM065L4KN	7-1589484-5
STM015M6AN	2-1589487-3	STM037L82AQ	0-1589486-5	STM065L82AQ	0-1589486-6
STM015M6DQ	2-1589487-4	STM037M5AN	3-1589488-3	STM065L82HN	0-1589486-7
STM015M6HN	2-1589487-5	STM037M5CN	3-1589488-4	STM065L84IQ	0-1589486-8
STM015M6N	2-1589487-6	STM037M5HN	3-1589488-5	STM065M5CN	4-1589488-4
STM015M6S	2-1589487-7	STM037M5N	3-1589488-6	STM065M5LQ	4-1589488-6
STM015M6SN	2-1589487-8	STM037M5PQ	3-1589488-7	STM065M5N	4-1589488-7
STM025B2N	0-1589490-4	STM037M5SN	3-1589488-8	STM065M6	5-1589487-0
STM025B42N	0-1589485-5	STM037M6AN	3-1589487-6	STM065M6CN	5-1589487-1
STM025B44	0-1589485-6	STM037M6AQ	3-1589487-7	STM065M6HN	5-1589487-3
STM025C5N	0-1589482-2	STM037M6DN	3-1589487-8	STM065M6SN	5-1589487-4
STM025C6N	0-1589481-4	STM037M6DQ	3-1589487-9	DUALOBE - Soldered to Flex (Duckbill)	
STM025L2AN	4-1589483-2	STM037M6HN	4-1589487-0	STL00911378PC	0-1589066-3
STM025L2AQ	4-1589483-3	STM037M6SN	4-1589487-1	STL00911378PCN	0-1589066-4
STM025L2CN	4-1589483-4	STM037M6SQ	4-1589487-2	STL00911378SCN	0-1589067-1
STM025L2HN	4-1589483-5	STM051B2N	0-1589490-6	STL01511378PCN	0-1589066-5
STM025L2HQ	4-1589483-6	STM051B2Q	0-1589490-8	STL02511378PCN	0-1589066-6
STM025L2IQ	4-1589483-7	STM051B42N	1-1589485-0	STL02511378SCN	0-1589067-2
STM025L2N	4-1589483-9	STM051C5N	0-1589482-3	STL03711378PCN	0-1589066-7
STM025L42KN	4-1589484-0	STM051C5Q	0-1589482-4	STL05111378PCN	0-1589066-8
STM025L44HN	4-1589484-2	STM051C6N	0-1589481-6	STL05111378SCHN	0-1589067-3
STM025L44KN	4-1589484-3	STM051L2AQ	6-1589483-0	STL06511378PC	0-1589066-9
STM025L44N	4-1589484-4	STM051L2CN	6-1589483-2	STL06511378PCN	1-1589066-0
STM025L44PQ	4-1589484-5	STM051L2HN	6-1589483-3	STL06511378SCN	0-1589067-4
STM025L44Q	4-1589484-6	STM051L2HQ	6-1589483-4	STM00911378PCN	1-1589066-1
STM025L4KN	4-1589484-7	STM051L2Q	6-1589483-6	STM00911378SCN	0-1589067-6
STM025L4LQ	4-1589484-8	STM051L2SN	6-1589483-8	STM01511378SCN	0-1589067-7
STM025L4PN	4-1589484-9	STM051L42HN	6-1589484-3	STM02511378PC	1-1589066-2
STM025L4PQ	5-1589484-0	STM051L42KN	6-1589484-4	STM02511378PCN	1-1589066-3
STM025L4SN	5-1589484-1	STM051L42N	6-1589484-5	STM02511378SCN	0-1589067-8
STM025L82HN	0-1589486-3	STM051L44HN	6-1589484-6	STM03711378PCN	1-1589066-4
STM025L84KN	0-1589486-4	STM051L44KN	6-1589484-7	STM03711378PCQ	1-1589066-5
STM025M5CN	2-1589488-8	STM051L44PQ	6-1589484-8	STM05111378PC	1-1589066-6
STM025M5HN	2-1589488-9	STM051L44Q	6-1589484-9	STM05111378PCM	1-1589066-7
STM025M5LQ	3-1589488-0	STM051L4KN	7-1589484-0	STM05111378PCN	1-1589066-8
STM025M5PQ	3-1589488-1	STM051L4PQ	7-1589484-1	STM05111378PCQ	1-1589066-9

NANONICS Part Number	Tyco Part Number
STM05111378SCN	0-1589067-9
STM06511378PCN	2-1589066-0
STM06511378PCQ	2-1589066-1
STM06511378SCN	1-1589067-0
DUALLOBE - Wire Terminations	
SSL005PC0DC006N	0-1589455-2
SSL005PC0DC012N	0-1589455-3
SSL005PC2DC004	0-1589455-4
SSL005PC2DC006	0-1589455-5
SSL005PC2DC006N	0-1589455-6
SSL005PC2DX006N	0-1589455-7
SSL005SC0DC006N	0-1589457-1
SSL005SC2DC006N	0-1589457-2
SSL005SC3DM024N	0-1589457-3
SSL009PC0DC006N	0-1589455-8
SSL009PC0DMM03N	0-1589455-9
SSL009PC2DC001N	1-1589455-0
SSL009PC2DC003	1-1589455-1
SSL009PC2DC006N	1-1589455-2
SSL009PC2DC009N	1-1589455-3
SSL009PC2DC012	1-1589455-4
SSL009PC2DC012M	1-1589455-5
SSL009PC2DC012N	1-1589455-6
SSL009PC2DC018N	1-1589455-7
SSL009PC2DCC03N	1-1589455-8
SSL009PC2DCC10N	1-1589455-9
SSL009PC2DM010N	2-1589455-0
SSL009PC2DM018M	2-1589455-1
SSL009PC2DMC60Q	2-1589455-2
SSL009SC0DMM03N	0-1589457-4
SSL009SC2DC003	0-1589457-5
SSL009SC2DC006N	0-1589457-6
SSL009SC2DC012	0-1589457-7
SSL009SC2DM006N	0-1589457-8
SSL009SC2GX006	1-1589457-0
SSL015PC0DMM03N	2-1589455-3
SSL015PC2DC006N	2-1589455-4
SSL015PC2DC008N	2-1589455-5
SSL015PC2DC012	2-1589455-6
SSL015PC2DC012N	2-1589455-7
SSL015PC2DC018	2-1589455-8
SSL015PC2DC024	2-1589455-9
SSL015PC2DM018M	3-1589455-0
SSL015SC0DMM03N	1-1589457-1
SSL015SC2DC006N	1-1589457-2
SSL015SC2DC012N	1-1589457-3
SSL015SC2DC024N	1-1589457-4
SSL025PC2DC006	3-1589455-1
SSL025PC2DC006N	3-1589455-2
SSL025PC2DC012	3-1589455-3
SSL025PC2DC020N	3-1589455-4
SSL025PC2DM018M	3-1589455-5
SSL025PC2DX012Q	3-1589455-6
SSL025PC2GX006N	3-1589455-7
SSL025SC2DC006	1-1589457-5
SSL025SC2DC006N	1-1589457-6
SSL025SC2DC012N	1-1589457-7
SSL037PC2DC012N	3-1589455-8
SSL037PC2DC024N	3-1589455-9
SSL037PC2DC096N	4-1589455-0
SSL037SC2DC012N	1-1589457-8

NANONICS Part Number	Tyco Part Number
SSL051PC2DC012N	4-1589455-1
SSM005PC2DC006	4-1589455-2
SSM005PC2DC006N	4-1589455-3
SSM005PC2DC012N	4-1589455-4
SSM005PC2DC018N	4-1589455-5
SSM005PC2DC036N	4-1589455-6
SSM005PC2DC040N	4-1589455-7
SSM005PC2DX012N	4-1589455-8
SSM005PC2DX018N	4-1589455-9
SSM005PC2DX024N	5-1589455-0
SSM005PC4DX012N	5-1589455-1
SSM005PC4DXM01	5-1589455-2
SSM005SC2DC006N	1-1589457-9
SSM005SC2DC012N	2-1589457-0
SSM005SC2DC018N	2-1589457-1
SSM005SC2DC040N	2-1589457-2
SSM005SC2DX024HN	2-1589457-3
SSM005SC4DX012N	2-1589457-4
SSM009PC0DC024N	5-1589455-3
SSM009PC0DM024N	5-1589455-4
SSM009PC0DX012N	5-1589455-5
SSM009PC2DC003	5-1589455-6
SSM009PC2DC003N	5-1589455-7
SSM009PC2DC006	5-1589455-8
SSM009PC2DC006N	5-1589455-9
SSM009PC2DC010N	6-1589455-0
SSM009PC2DC012	6-1589455-1
SSM009PC2DC012M	6-1589455-2
SSM009PC2DC012N	6-1589455-3
SSM009PC2DC018	6-1589455-4
SSM009PC2DC018N	6-1589455-5
SSM009PC2DC024	6-1589455-6
SSM009PC2DC024N	6-1589455-7
SSM009PC2DC036N	6-1589455-8
SSM009PC2DC060N	6-1589455-9
SSM009PC2DCC10N	7-1589455-0
SSM009PC2DCM01N	7-1589455-1
SSM009PC2DM010N	7-1589455-2
SSM009PC2DM018N	7-1589455-3
SSM009PC2DM024	7-1589455-4
SSM009PC2DX005N	7-1589455-5
SSM009PC2DX006N	7-1589455-6
SSM009PC2DX010N	7-1589455-7
SSM009PC2DX012N	7-1589455-8
SSM009PC2DX018N	7-1589455-9
SSM009PC2DX024N	8-1589455-0
SSM009PC2DY006N	8-1589455-1
SSM009PC3DC018N	8-1589455-2
SSM009SC1DC002	2-1589457-5
SSM009SC2DC006HN	2-1589457-6
SSM009SC2DC006N	2-1589457-7
SSM009SC2DC012N	2-1589457-9
SSM009SC2DC018N	3-1589457-0
SSM009SC2DC024N	3-1589457-1
SSM009SC2DC036N	3-1589457-2
SSM009SC2DM006N	3-1589457-4
SSM009SC2DM012	3-1589457-5
SSM009SC2DX012N	3-1589457-6
SSM009SC2DX018N	3-1589457-7
SSM009SC2DX024HN	3-1589457-8
SSM009SC2DX036HN	3-1589457-9

NANONICS Part Number	Tyco Part Number
SSM015PC0DC012N	8-1589455-3
SSM015PC0DC018N	8-1589455-4
SSM015PC0DMM02N	8-1589455-5
SSM015PC2DC003N	8-1589455-6
SSM015PC2DC006	8-1589455-7
SSM015PC2DC006N	8-1589455-8
SSM015PC2DC008N	8-1589455-9
SSM015PC2DC012	9-1589455-0
SSM015PC2DC012N	9-1589455-1
SSM015PC2DC018	9-1589455-2
SSM015PC2DC018N	9-1589455-3
SSM015PC2DC024N	9-1589455-4
SSM015PC2DC036N	9-1589455-5
SSM015PC2DC048N	9-1589455-6
SSM015PC2DC060N	9-1589455-7
SSM015PC2DM024N	9-1589455-8
SSM015PC2DMC20N	9-1589455-9
SSM015PC2DMM02N	0-1589456-1
SSM015PC2DT012N	0-1589456-2
SSM015PC2DX006N	0-1589456-3
SSM015PC2DX006Q	0-1589456-4
SSM015PC2DX008	0-1589456-5
SSM015PC2DX012N	0-1589456-6
SSM015PC2DX024N	0-1589456-7
SSM015PC2DY003N	0-1589456-8
SSM015PC2DY006N	0-1589456-9
SSM015PC2DY012N	1-1589456-0
SSM015PC2GX018N	1-1589456-1
SSM015PC4DX030N	1-1589456-2
SSM015SC0DC012N	4-1589457-0
SSM015SC2DC003N	4-1589457-1
SSM015SC2DC006N	4-1589457-2
SSM015SC2DC012N	4-1589457-3
SSM015SC2DC018	4-1589457-4
SSM015SC2DC036N	4-1589457-5
SSM015SC2DX006N	4-1589457-8
SSM015SC2DX012HN	4-1589457-9
SSM015SC2DX018N	5-1589457-0
SSM015SC2DX024HN	5-1589457-2
SSM015SC2DY012N	5-1589457-3
SSM015SC2DY018N	5-1589457-4
SSM015SC4DX005N	5-1589457-5
SSM025PC2DC003N	1-1589456-4
SSM025PC2DC006Q	1-1589456-5
SSM025PC2DC010N	1-1589456-6
SSM025PC2DC012	1-1589456-7
SSM025PC2DC012N	1-1589456-8
SSM025PC2DC018	1-1589456-9
SSM025PC2DC018N	2-1589456-0
SSM025PC2DC025N	2-1589456-1
SSM025PC2DC030N	2-1589456-2
SSM025PC2DC036N	2-1589456-3
SSM025PC2DCC30N	2-1589456-4
SSM025PC2DX006N	2-1589456-5
SSM025PC2DX012N	2-1589456-6
SSM025PC2DX018N	2-1589456-7
SSM025PC2DX024N	2-1589456-8
SSM025PC2GX006	2-1589456-9
SSM025PC2GX018N	3-1589456-0
SSM025PC3DY006N	3-1589456-1
SSM025SC2DC012N	5-1589457-6

NANONICS Part Number	Tyco Part Number	NANONICS Part Number	Tyco Part Number	NANONICS Part Number	Tyco Part Number
SSM025SC2DC018	5-1589457-7	STL015PC2DC010N	2-1589472-8	STL051PC2DC012	7-1589472-0
SSM025SC2DC024N	5-1589457-9	STL015PC2DC012	2-1589472-9	STL051PC2DC012N	7-1589472-1
SSM025SC2DX006N	6-1589457-0	STL015PC2DC012N	3-1589472-0	STL051PC2DC018	7-1589472-2
SSM025SC2DX018N	6-1589457-1	STL015PC2DC015N	3-1589472-1	STL051PC2DC024N	7-1589472-3
SSM025SC2DX024HN	6-1589457-3	STL015PC2DC018M	3-1589472-2	STL051PC2DC036N	7-1589472-4
SSM025SC3DY006N	6-1589457-4	STL015PC2DC030N	3-1589472-3	STL051PC2DC040N	7-1589472-5
SSM037PC2DC006	3-1589456-2	STL015PC2DC036N	3-1589472-4	STL051PC2DCC35N	7-1589472-6
SSM037PC2DC006N	3-1589456-3	STL015PC2DCC10N	3-1589472-5	STL051SC2DC003N	3-1589476-0
SSM037PC2DC012	3-1589456-4	STL015PC2DM010N	3-1589472-6	STL051SC2DC012N	3-1589476-1
SSM037PC2DC012N	3-1589456-5	STL015PC2DX010N	3-1589472-8	STL051SC2DC018N	3-1589476-2
SSM037PC2DC015N	3-1589456-6	STL015PC2DX036N	3-1589472-9	STL051SC2DC024N	3-1589476-3
SSM037PC2DC018	3-1589456-7	STL015PC2GX040N	4-1589472-0	STL051SC2DC048	3-1589476-4
SSM037PC2DC018N	3-1589456-8	STL015SC0DMM03N	1-1589476-0	STL065PC0DC036N	7-1589472-8
SSM037PC2DC024N	3-1589456-9	STL015SC2DC008	1-1589476-1	STL065PC2DC006	7-1589472-9
SSM037PC2DCM01N	4-1589456-0	STL015SC2DC008N	1-1589476-2	STL065PC2DC006N	8-1589472-0
SSM037PC2DX012Q	4-1589456-2	STL015SC2DC012N	1-1589476-3	STL065PC2DC012N	8-1589472-1
SSM037PC2DX018N	4-1589456-3	STL015SC2DC018N	1-1589476-4	STL065PC2DC018	8-1589472-2
SSM037PC2GXC30N	4-1589456-4	STL015SC2DC030N	1-1589476-5	STL065PC2DC018N	8-1589472-3
SSM037SC2DC018	6-1589457-5	STL015SC2DC036N	1-1589476-6	STL065PC2DC024N	8-1589472-4
SSM037SC2DC018N	6-1589457-6	STL015SC2DX010N	1-1589476-7	STL065PC2DC036N	8-1589472-5
SSM051PC2DC006	4-1589456-5	STL015SC3DX024N	1-1589476-8	STL065PC2DC040N	8-1589472-6
SSM051PC2DC006N	4-1589456-6	STL025PC2DC006	4-1589472-1	STL065PC2DC072N	8-1589472-7
SSM051PC2DC012N	4-1589456-7	STL025PC2DC006N	4-1589472-2	STL065PC2DCC10N	8-1589472-8
SSM051PC2DC018	4-1589456-8	STL025PC2DC010N	4-1589472-3	STL065PC2DM018N	8-1589472-9
SSM051PC2DC024	4-1589456-9	STL025PC2DC012	4-1589472-4	STL065PC2DM036N	9-1589472-0
SSM051PC2DC024N	5-1589456-0	STL025PC2DC012N	4-1589472-5	STL065PC2GX036Q	9-1589472-1
SSM051PC2DC030N	5-1589456-1	STL025PC2DC015N	4-1589472-6	STL065PC3DM072N	9-1589472-2
SSM051PC2DCC06Q	5-1589456-2	STL025PC2DC018N	4-1589472-7	STL065PC2DC006N	3-1589476-6
SSM051PC2DM012Q	5-1589456-3	STL025PC2DC020N	4-1589472-8	STL065SC2DC012N	3-1589476-7
SSM051PC2DM024N	5-1589456-4	STL025PC2DC030N	4-1589472-9	STL065SC2DC048N	3-1589476-8
SSM051PC2DMC10N	5-1589456-5	STL025PC2DM010N	5-1589472-0	STL065SC2DM036N	3-1589476-9
SSM051PC2DMC30N	5-1589456-6	STL025PC3DX006N	5-1589472-1	STL065SC3DM072N	4-1589476-0
SSM051PC2DX008	5-1589456-9	STL025PC4DX030N	5-1589472-2	STM009PC0DC020N	9-1589472-3
SSM051PC2DXM05Q	6-1589456-0	STL025SC2DC001N	1-1589476-9	STM009PC0DX10N	9-1589472-4
SSM051PC2DY012N	6-1589456-1	STL025SC2DC006N	2-1589476-0	STM009PC2DC003N	9-1589472-5
SSM051PC2GX012N	6-1589456-2	STL025SC2DC012N	2-1589476-1	STM009PC2DC004N	9-1589472-6
SSM051SC2DC018	6-1589457-7	STL025SC2DC030N	2-1589476-2	STM009PC2DC006	9-1589472-7
SSM051SC2DC018N	6-1589457-8	STL025SC2DC036N	2-1589476-3	STM009PC2DC006N	9-1589472-8
SSM051SC2DNC15Q	6-1589457-9	STL037PC2DC010N	5-1589472-3	STM009PC2DC012	9-1589472-9
SSM051SC2DT021	7-1589457-1	STL037PC2DC012	5-1589472-4	STM009PC2DC012N	0-1589473-1
SSM051SC2GX012N	7-1589457-3	STL037PC2DC012M	5-1589472-5	STM009PC2DC016N	0-1589473-2
STL009PC2DC012	1-1589472-1	STL037PC2DC012N	5-1589472-6	STM009PC2DC018N	0-1589473-3
STL009PC2DC012N	1-1589472-2	STL037PC2DC017N	5-1589472-7	STM009PC2DC019	0-1589473-4
STL009PC2DC018	1-1589472-3	STL037PC2DC018M	5-1589472-8	STM009PC2DC020Q	0-1589473-5
STL009PC2DC018M	1-1589472-4	STL037PC2DC018N	5-1589472-9	STM009PC2DC024	0-1589473-6
STL009PC2DC018N	1-1589472-5	STL037PC2DC020Q	6-1589472-0	STM009PC2DC024N	0-1589473-7
STL009PC2DC036N	1-1589472-6	STL037PC2DC036M	6-1589472-1	STM009PC2DC028N	0-1589473-8
STL009PC2DM010N	1-1589472-7	STL037PC2DC036N	6-1589472-2	STM009PC2DC030N	0-1589473-9
STL009PC2DX024N	1-1589472-8	STL037PC2DC040N	6-1589472-3	STM009PC2DC036	1-1589473-0
STL009PC2GX010N	1-1589472-9	STL037PC2DCC15N	6-1589472-4	STM009PC2DC036M	1-1589473-1
STL009PC3DX024N	2-1589472-0	STL037PC2DM010N	6-1589472-5	STM009PC2DC036N	1-1589473-2
STL009PC3DX030N	2-1589472-1	STL037PC2GX005N	6-1589472-6	STM009PC2DC060Q	1-1589473-3
STL009SC2DC012	0-1589476-6	STL037SC2DC012N	2-1589476-4	STM009PC2DCC40N	1-1589473-4
STL009SC2DC012N	0-1589476-7	STL037SC2DC012Q	2-1589476-5	STM009PC2DCC90Q	1-1589473-5
STL009SC2DC036N	0-1589476-8	STL037SC2DC030N	2-1589476-6	STM009PC2DCM01N	1-1589473-6
STL009SC3DX024N	0-1589476-9	STL037SC2DC036N	2-1589476-7	STM009PC2DM012N	1-1589473-7
STL015PC0DC006N	2-1589472-2	STL037SC2DCC15N	2-1589476-8	STM009PC2DM012Q	1-1589473-8
STL015PC0DC012Q	2-1589472-3	STL037SC3DX024N	2-1589476-9	STM009PC2DM018N	1-1589473-9
STL015PC0DMM03N	2-1589472-4	STL051PC0DXC50N	6-1589472-7	STM009PC2DM036N	2-1589473-0
STL015PC2DC006	2-1589472-6	STL051PC2DC003N	6-1589472-8	STM009PC2DT018N	2-1589473-2
STL015PC2DC008	2-1589472-7	STL051PC2DC006N	6-1589472-9	STM009PC2DT030N	2-1589473-3

NANONICS Part Number	Tyco Part Number	NANONICS Part Number	Tyco Part Number	NANONICS Part Number	Tyco Part Number
STM009PC2DX010N	2-1589473-4	STM015PC2DX030N	6-1589473-7	STM025PC2DC180N	9-1589473-9
STM009PC2DX024N	2-1589473-5	STM015PC2DX048N	6-1589473-8	STM025PC2DCC40N	0-1589474-1
STM009PC2DXC15Q	2-1589473-6	STM015PC2DXC15Q	6-1589473-9	STM025PC2DCC50N	0-1589474-2
STM009SC0DX012N	4-1589476-1	STM015PC2GX004N	7-1589473-0	STM025PC2DCC60N	0-1589474-3
STM009SC2DC006	4-1589476-2	STM015PC3DX024N	7-1589473-1	STM025PC2DM006Q	0-1589474-4
STM009SC2DC006HN	4-1589476-3	STM015PC4DX012N	7-1589473-2	STM025PC2DM012Q	0-1589474-5
STM009SC2DC006N	4-1589476-4	STM015SC0DXC10N	6-1589476-7	STM025PC2DM018N	0-1589474-6
STM009SC2DC012HN	4-1589476-5	STM015SC0DXC10Q	6-1589476-8	STM025PC2DM024N	0-1589474-7
STM009SC2DC012N	4-1589476-6	STM015SC2DC003N	7-1589476-1	STM025PC2DM036N	0-1589474-8
STM009SC2DC012Q	4-1589476-7	STM015SC2DC004HN	7-1589476-2	STM025PC2DT012N	0-1589474-9
STM009SC2DC018HN	4-1589476-9	STM015SC2DC006N	7-1589476-3	STM025PC2DT030N	1-1589474-0
STM009SC2DC018N	5-1589476-0	STM015SC2DC008HN	7-1589476-4	STM025PC2DT036Q	1-1589474-1
STM009SC2DC024N	5-1589476-1	STM015SC2DC012HN	7-1589476-5	STM025PC2DT048Q	1-1589474-2
STM009SC2DC036HN	5-1589476-2	STM015SC2DC012N	7-1589476-6	STM025PC2DX005	1-1589474-3
STM009SC2DC036N	5-1589476-3	STM015SC2DC016N	7-1589476-7	STM025PC2DX006N	1-1589474-4
STM009SC2DC048N	5-1589476-4	STM015SC2DC018N	7-1589476-8	STM025PC2DX006Q	1-1589474-5
STM009SC2DC060Q	5-1589476-5	STM015SC2DC024N	7-1589476-9	STM025PC2DX010N	1-1589474-6
STM009SC2DCM01HN	5-1589476-6	STM015SC2DC036N	8-1589476-0	STM025PC2DX012N	1-1589474-7
STM009SC2DCM02N	5-1589476-7	STM015SC2DC060Q	8-1589476-1	STM025PC2DX018N	1-1589474-8
STM009SC2DM018HN	5-1589476-8	STM015SC2DCC30N	8-1589476-2	STM025PC2DX048N	1-1589474-9
STM009SC2DM036N	5-1589476-9	STM015SC2DCM01HN	8-1589476-3	STM025PC2DY004	2-1589474-0
STM009SC2DT012HN	6-1589476-0	STM015SC2DM006N	8-1589476-4	STM025PC2DY006	2-1589474-1
STM009SC2DT012N	6-1589476-1	STM015SC2DMM01N	8-1589476-5	STM025PC2DY006N	2-1589474-2
STM009SC2DT030N	6-1589476-2	STM015SC2DT006Q	8-1589476-6	STM025PC4DX012M	2-1589474-4
STM009SC2DX010N	6-1589476-3	STM015SC2DT012HN	8-1589476-7	STM025PC4DX012N	2-1589474-5
STM009SC2DX012HN	6-1589476-4	STM015SC2DT030N	8-1589476-8	STM025SC2DC003	9-1589476-8
STM009SC2DX012N	6-1589476-5	STM015SC2DX005HN	8-1589476-9	STM025SC2DC004	9-1589476-9
STM009SC2DXC15Q	6-1589476-6	STM015SC2DX006HN	9-1589476-0	STM025SC2DC006N	0-1589477-1
STM015PC0DCM02Q	2-1589473-9	STM015SC2DX010N	9-1589476-1	STM025SC2DC008N	0-1589477-2
STM015PC0DM012N	3-1589473-0	STM015SC2DX012N	9-1589476-2	STM025SC2DC012HN	0-1589477-3
STM015PC2DC003N	3-1589473-6	STM015SC2DX018HN	9-1589476-3	STM025SC2DC012N	0-1589477-4
STM015PC2DC005N	3-1589473-7	STM015SC2DXC15Q	9-1589476-4	STM025SC2DC016N	0-1589477-5
STM015PC2DC006N	3-1589473-8	STM015SC4DX012Q	9-1589476-5	STM025SC2DC018N	0-1589477-6
STM015PC2DC012N	3-1589473-9	STM015SC4DX030N	9-1589476-6	STM025SC2DC020N	0-1589477-7
STM015PC2DC012Q	4-1589473-0	STM015SC4DXC20N	9-1589476-7	STM025SC2DC024N	0-1589477-8
STM015PC2DC016N	4-1589473-1	STM025PC0DC012N	7-1589473-3	STM025SC2DC036N	0-1589477-9
STM015PC2DC018N	4-1589473-2	STM025PC0DM012N	7-1589473-4	STM025SC2DC040N	1-1589477-0
STM015PC2DC020Q	4-1589473-3	STM025PC2DC003	7-1589473-5	STM025SC2DC048HN	1-1589477-1
STM015PC2DC024N	4-1589473-4	STM025PC2DC003N	7-1589473-6	STM025SC2DC048N	1-1589477-2
STM015PC2DC030N	4-1589473-5	STM025PC2DC004	7-1589473-7	STM025SC2DC060HN	1-1589477-3
STM015PC2DC036	4-1589473-6	STM025PC2DC006	7-1589473-8	STM025SC2DC060Q	1-1589477-4
STM015PC2DC036M	4-1589473-7	STM025PC2DC006N	7-1589473-9	STM025SC2DC180N	1-1589477-5
STM015PC2DC036N	4-1589473-8	STM025PC2DC008N	8-1589473-0	STM025SC2DCC60N	1-1589477-6
STM015PC2DC048N	4-1589473-9	STM025PC2DC010N	8-1589473-1	STM025SC2DT012HN	1-1589477-7
STM015PC2DC060Q	5-1589473-0	STM025PC2DC012	8-1589473-2	STM025SC2DT030N	1-1589477-8
STM015PC2DC120N	5-1589473-1	STM025PC2DC012N	8-1589473-3	STM025SC2DX005HN	1-1589477-9
STM015PC2DCC30N	5-1589473-2	STM025PC2DC015N	8-1589473-4	STM025SC2DX006N	2-1589477-0
STM015PC2DCC90Q	5-1589473-3	STM025PC2DC016N	8-1589473-5	STM025SC2DX010N	2-1589477-1
STM015PC2DCM01N	5-1589473-4	STM025PC2DC018N	8-1589473-6	STM025SC2DX012N	2-1589477-2
STM015PC2DM018N	5-1589473-5	STM025PC2DC020N	8-1589473-7	STM025SC2DX018N	2-1589477-3
STM015PC2DM024N	5-1589473-6	STM025PC2DC020Q	8-1589473-8	STM025SC2DY018N	2-1589477-4
STM015PC2DM036N	5-1589473-7	STM025PC2DC024N	8-1589473-9	STM025SC3DC012N	2-1589477-5
STM015PC2DMM01N	5-1589473-8	STM025PC2DC024Q	9-1589473-0	STM025SC3DMC20DQ	2-1589477-6
STM015PC2DT006Q	5-1589473-9	STM025PC2DC030N	9-1589473-1	STM025SC4DX030N	2-1589477-7
STM015PC2DT012N	6-1589473-0	STM025PC2DC036M	9-1589473-2	STM037PC0DC009N	2-1589474-6
STM015PC2DT030N	6-1589473-1	STM025PC2DC036N	9-1589473-3	STM037PC0DXC10N	2-1589474-7
STM015PC2DT036N	6-1589473-2	STM025PC2DC048N	9-1589473-4	STM037PC2DC003N	2-1589474-8
STM015PC2DTC45N	6-1589473-3	STM025PC2DC060N	9-1589473-5	STM037PC2DC005N	2-1589474-9
STM015PC2DX010N	6-1589473-4	STM025PC2DC060Q	9-1589473-6	STM037PC2DC006M	3-1589474-0
STM015PC2DX012N	6-1589473-5	STM025PC2DC072N	9-1589473-7	STM037PC2DC006N	3-1589474-1
STM015PC2DX024N	6-1589473-6	STM025PC2DC120N	9-1589473-8	STM037PC2DC012	3-1589474-2

NANONICS Part Number	Tyco Part Number
STM037PC2DC012M	3-1589474-3
STM037PC2DC012N	3-1589474-4
STM037PC2DC012Q	3-1589474-5
STM037PC2DC015N	3-1589474-6
STM037PC2DC015Q	3-1589474-7
STM037PC2DC018N	3-1589474-9
STM037PC2DC020Q	4-1589474-0
STM037PC2DC024	4-1589474-1
STM037PC2DC024N	4-1589474-2
STM037PC2DC030N	4-1589474-3
STM037PC2DC036	4-1589474-4
STM037PC2DC036N	4-1589474-5
STM037PC2DC036Q	4-1589474-6
STM037PC2DC048N	4-1589474-7
STM037PC2DC060Q	4-1589474-8
STM037PC2DC072N	4-1589474-9
STM037PC2DCC20Q	5-1589474-0
STM037PC2DCC50N	5-1589474-1
STM037PC2DCM01Q	5-1589474-2
STM037PC2DM018N	5-1589474-3
STM037PC2DM024M	5-1589474-4
STM037PC2DM024N	5-1589474-5
STM037PC2DT012N	5-1589474-7
STM037PC2DT030N	5-1589474-8
STM037PC2DX006N	5-1589474-9
STM037PC2DX010N	6-1589474-0
STM037PC2DX012N	6-1589474-1
STM037PC2DX024N	6-1589474-2
STM037PC2GX006N	6-1589474-3
STM037PC3DC012N	6-1589474-4
STM037SC0DXC10N	2-1589477-8
STM037SC2DC006N	2-1589477-9
STM037SC2DC006Q	3-1589477-0
STM037SC2DC012N	3-1589477-1
STM037SC2DC015N	3-1589477-2
STM037SC2DC018HN	3-1589477-3
STM037SC2DC018N	3-1589477-4
STM037SC2DC020Q	3-1589477-5
STM037SC2DC024N	3-1589477-6
STM037SC2DC036N	3-1589477-7
STM037SC2DC060Q	3-1589477-8
STM037SC2DM024N	3-1589477-9
STM037SC2DT030N	4-1589477-0
STM037SC2DX006N	4-1589477-1
STM037SC2DX010N	4-1589477-2
STM037SC2DX012N	4-1589477-3
STM037SC2GX006N	4-1589477-4
STM051PC0DC012N	6-1589474-5
STM051PC0DC048N	6-1589474-6
STM051PC0DXC10N	6-1589474-7
STM051PC1DXC20	6-1589474-8
STM051PC2DC003N	6-1589474-9
STM051PC2DC006	7-1589474-0
STM051PC2DC006N	7-1589474-1
STM051PC2DC012N	7-1589474-2
STM051PC2DC012Q	7-1589474-3
STM051PC2DC015N	7-1589474-4
STM051PC2DC016N	7-1589474-5
STM051PC2DC018	7-1589474-6
STM051PC2DC018N	7-1589474-7
STM051PC2DC018Q	7-1589474-8

NANONICS Part Number	Tyco Part Number
STM051PC2DC024N	7-1589474-9
STM051PC2DC030N	8-1589474-0
STM051PC2DC036N	8-1589474-1
STM051PC2DC036Q	8-1589474-2
STM051PC2DC060N	8-1589474-3
STM051PC2DC060Q	8-1589474-4
STM051PC2DCC20N	8-1589474-5
STM051PC2DM018N	8-1589474-6
STM051PC2DMM01N	8-1589474-7
STM051PC2DT012N	8-1589474-9
STM051PC2DT030N	9-1589474-0
STM051PC2DT036N	9-1589474-1
STM051PC2DT072N	9-1589474-2
STM051PC2DX012N	9-1589474-3
STM051PC2DX012Q	9-1589474-4
STM051PC2DX015N	9-1589474-5
STM051PC2DX018	9-1589474-6
STM051PC2DX018N	9-1589474-7
STM051PC2DY015N	9-1589474-8
STM051PC2GXM01N	9-1589474-9
STM051SC0DXC10N	4-1589477-5
STM051SC1DXC20	4-1589477-6
STM051SC2DC003N	4-1589477-7
STM051SC2DC006	4-1589477-8
STM051SC2DC006N	4-1589477-9
STM051SC2DC012N	5-1589477-0
STM051SC2DC015HN	5-1589477-1
STM051SC2DC015N	5-1589477-2
STM051SC2DC016N	5-1589477-3
STM051SC2DC018HN	5-1589477-4
STM051SC2DC018N	5-1589477-5
STM051SC2DC018Q	5-1589477-6
STM051SC2DC036N	5-1589477-7
STM051SC2DC060N	5-1589477-8
STM051SC2DC060Q	5-1589477-9
STM051SC2DM012N	6-1589477-0
STM051SC2DMM01N	6-1589477-1
STM051SC2DT030N	6-1589477-3
STM051SC2DX012N	6-1589477-4
STM051SC2DX015N	6-1589477-5
STM065PC2DC003N	0-1589475-1
STM065PC2DC006	0-1589475-2
STM065PC2DC006N	0-1589475-3
STM065PC2DC008Q	0-1589475-4
STM065PC2DC012N	0-1589475-5
STM065PC2DC012Q	0-1589475-6
STM065PC2DC016M	0-1589475-7
STM065PC2DC016N	0-1589475-8
STM065PC2DC018M	0-1589475-9
STM065PC2DC018N	1-1589475-0
STM065PC2DC018Q	1-1589475-1
STM065PC2DC024N	1-1589475-2
STM065PC2DC024Q	1-1589475-3
STM065PC2DC030N	1-1589475-4
STM065PC2DC036N	1-1589475-5
STM065PC2DC072N	1-1589475-6
STM065PC2DM018N	1-1589475-7
STM065PC2DT018N	1-1589475-8
STM065PC2DT030N	1-1589475-9
STM065PC2DX006N	2-1589475-0
STM065PC2DX018N	2-1589475-1

NANONICS Part Number	Tyco Part Number
STM065PC2DX036N	2-1589475-2
STM065PC2DY012N	2-1589475-3
STM065PC2DY024N	2-1589475-4
STM065PC2GXM01N	2-1589475-5
STM065PC3DM006N	2-1589475-6
STM065PC3DX024N	2-1589475-7
STM065SC2DC003N	6-1589477-6
STM065SC2DC006	6-1589477-7
STM065SC2DC006N	6-1589477-8
STM065SC2DC012N	6-1589477-9
STM065SC2DC012Q	7-1589477-0
STM065SC2DC015N	7-1589477-1
STM065SC2DC018	7-1589477-2
STM065SC2DC018N	7-1589477-3
STM065SC2DC018Q	7-1589477-4
STM065SC2DC024N	7-1589477-5
STM065SC2DC024Q	7-1589477-6
STM065SC2DC036HN	7-1589477-7
STM065SC2DC036N	7-1589477-8
STM065SC2DT030N	7-1589477-9
DUALOBE - Solder Cup Termination	
SSL00511500PCN	0-1589051-1
SSL00511500SCN	0-1589052-1
SSL00911500PC	0-1589051-2
SSL00911500PCN	0-1589051-3
SSL00911500SCN	0-1589052-2
SSL01511500PCM	0-1589051-4
SSL01511500PCN	0-1589051-5
SSL01511500SCN	0-1589052-3
SSM00511500PC	1-1589051-4
SSM00511500PCN	0-1589051-7
SSM00511500SCN	0-1589052-4
SSM00911500PC	0-1589051-8
SSM00911500PCN	0-1589051-9
SSM01511500PCN	1-1589051-0
SSM01511500SC	0-1589052-5
SSM02511500SCQ	0-1589052-7
SSM03711500PC	1-1589051-1
SSM03711500PCN	1-1589051-2
SSM05111500PCN	1-1589051-3
SSM05111500SCN	0-1589052-8
STL00911500PCN	0-1589053-1
STL00911500SCN	0-1589054-1
STL01511500PCN	0-1589053-2
STL01511500SCN	0-1589054-2
STL02511500PC	0-1589053-3
STL02511500PCN	0-1589053-4
STL02511500SC	0-1589054-3
STL03711500PCN	0-1589053-5
STL03711500SCN	0-1589054-4
STL05111500PCN	0-1589053-6
STL06511500PCN	1-1589053-8
STM00911500PCN	0-1589053-7
STM00911500SCN	0-1589054-5
STM01511500PCN	0-1589053-8
STM01511500PCQ	0-1589053-9
STM01511500SCHN	0-1589054-6
STM01511500SCN	0-1589054-7
STM02511500PC	1-1589053-0
STM02511500PCN	1-1589053-1
STM02511500SC	0-1589054-8

NANONICS Part Number	Tyco Part Number	NANONICS Part Number	Tyco Part Number	NANONICS Part Number	Tyco Part Number
STM02511500SCN	0-1589054-9	USS004PC2DCC30	0-1589448-9	USS009SC2DC012Z	2-1589449-7
STM03711500PCN	1-1589053-2	USS004PC2DX006	1-1589448-1	USS009SC2DC018	2-1589449-8
STM03711500PCQ	1-1589053-3	USS004PC2DX012	1-1589448-2	USS009SC2DC018T	2-1589449-9
STM03711500SCN	1-1589054-0	USS004PC2GX006	1-1589448-3	USS009SC2DC024	3-1589449-0
STM05111500PCN	1-1589053-4	USS004PC2GX024	1-1589448-4	USS009SC2DC025T	3-1589449-1
STM05111500PCQ	1-1589053-5	USS004PC3DC018	1-1589448-5	USS009SC2DC036T	3-1589449-2
STM05111500SCN	1-1589054-1	USS004SC2DC002	0-1589449-1	USS009SC2DC036U	3-1589449-3
STM06511500PC	1-1589053-6	USS004SC2DC003	0-1589449-2	USS009SC2DC036V	3-1589449-4
STM06511500PCN	1-1589053-7	USS004SC2DC003T	0-1589449-3	USS009SC2DC036W	3-1589449-5
STM06511500SCN	1-1589054-2	USS004SC2DC004	0-1589449-4	USS009SC2DC060T	3-1589449-6
Strip - Surface Mount & Thru Hole					
USS004B2	0-1589451-1	USS004SC2DC006	0-1589449-5	USS009SC2DCC05T	3-1589449-7
USS004B2T	0-1589451-2	USS004SC2DC012	0-1589449-6	USS009SC2DCM01T	3-1589449-8
USS004C6	0-1589453-1	USS004SC2DC012T	0-1589449-7	USS009SC2DX004T	3-1589449-9
USS004L2	0-1589452-1	USS004SC2DC012U	0-1589449-8	USS009SC2DX006T	4-1589449-0
USS004L2T	0-1589452-2	USS004SC2DC024	0-1589449-9	USS009SC2DX012	4-1589449-1
USS004M6	0-1589454-1	USS004SC2DC036	1-1589449-0	USS009SC2GX006	4-1589449-2
USS009B2	0-1589451-3	USS004SC2DC048	1-1589449-1	USS009SC2GX012	4-1589449-3
USS009B2T	0-1589451-5	USS004SC2DCC30	1-1589449-2	USS009SC3DX004T	4-1589449-4
USS009B2Z	0-1589451-6	USS004SC2DX006	1-1589449-4	USS010SC2DC006	4-1589449-5
USS009C6	0-1589453-2	USS004SC2DX012T	1-1589449-5	USS015PC2DC006	3-1589448-5
USS009C6T	0-1589453-3	USS004SC2GX006	1-1589449-6	USS015PC2DC012	3-1589448-6
USS009C6V	0-1589453-4	USS004SC2GX024	1-1589449-7	USS015PC2DC012T	3-1589448-7
USS009L2	0-1589452-3	USS004SC3DC018	1-1589449-8	USS015PC2DC012V	3-1589448-8
USS009L2T	0-1589452-4	USS004SC3DX004T	1-1589449-9	USS015PC2DC018	3-1589448-9
USS009L2U	0-1589452-5	USS009PC0DC006T	1-1589448-6	USS015PC2DMC60T	4-1589448-0
USS009L2V	0-1589452-6	USS009PC2DC006	1-1589448-7	USS015PC2DX004T	4-1589448-1
USS009M6	0-1589454-2	USS009PC2DC006W	1-1589448-8	USS015PC2DX012	4-1589448-2
USS015B2	0-1589451-8	USS009PC2DC012	1-1589448-9	USS015PC2DX024T	4-1589448-3
USS015B2T	0-1589451-9	USS009PC2DC012T	2-1589448-0	USS015SC2DC006	4-1589449-6
USS015C6	0-1589453-5	USS009PC2DC012V	2-1589448-1	USS015SC2DC012	4-1589449-7
USS015L2	0-1589452-7	USS009PC2DC018V	2-1589448-2	USS015SC2DC012T	4-1589449-8
USS015L2T	0-1589452-8	USS009PC2DC024	2-1589448-3	USS015SC2DC036T	4-1589449-9
USS015L2V	0-1589452-9	USS009PC2DC036	2-1589448-4	USS015SC2DMC60T	5-1589449-0
USS025B2	1-1589451-0	USS009PC2DC036T	2-1589448-5	USS015SC2DX004T	5-1589449-1
USS025L2	1-1589452-0	USS009PC2DC036U	2-1589448-6	USS015SC2DX018T	5-1589449-2
USS037B2	1-1589451-1	USS009PC2DC036V	2-1589448-7	USS015SC3DX004T	5-1589449-3
USS037L2	1-1589452-1	USS009PC2DCC05T	2-1589448-8	USS025PC2DC006	4-1589448-4
USS037L2T	1-1589452-2	USS009PC2DX001	2-1589448-9	USS025PC2DX018T	4-1589448-5
USS051B2	1-1589451-3	USS009PC2DX004T	3-1589448-0	USS025SC2DC006	5-1589449-4
USS051L2	1-1589452-3	USS009PC2DX006T	3-1589448-1	USS037PC1DXC20	4-1589448-6
Strip - Wire Terminations					
USS004PC2DC003	0-1589448-1	USS009PC2DX012	3-1589448-2	USS037PC2DC006	4-1589448-7
USS004PC2DC006	0-1589448-2	USS009PC2GX006	3-1589448-3	USS037PC2DC020T	4-1589448-8
USS004PC2DC012	0-1589448-3	USS009PC2GX012	3-1589448-4	USS037SC1DXC20	5-1589449-5
USS004PC2DC012T	0-1589448-4	USS009SC2DC004	2-1589449-0	USS037SC2DC006	5-1589449-6
USS004PC2DC012U	0-1589448-5	USS009SC2DC006	2-1589449-1	USS037SC2DX006T	5-1589449-7
USS004PC2DC024	0-1589448-6	USS009SC2DC006W	2-1589449-2	USS051PC2DC012	5-1589448-0
USS004PC2DC036	0-1589448-7	USS009SC2DC006Z	2-1589449-3	USS051PC2DX012	5-1589448-1
USS004PC2DC036T	0-1589448-8	USS009SC2DC008	2-1589449-4	USS051SC2DC012	5-1589448-8
		USS009SC2DC012	2-1589449-5		
		USS009SC2DC012T	2-1589449-6		

Introduction

Product Facts

- Designed for both military and commercial applications
- Low engaging force is achieved by the manner in which Twist Pin Contacts are designed
- The metal shell and plastic shell are available with solder cup and solid or stranded wire terminations
- Mating force maximum is 10 oz. [2.78N] times the number of contacts
- Durability — No known mechanical or electrical issues detrimental to the function of the connectors after 500 cycles of mating and unmating
- Current Rating — 3 amps max per contact

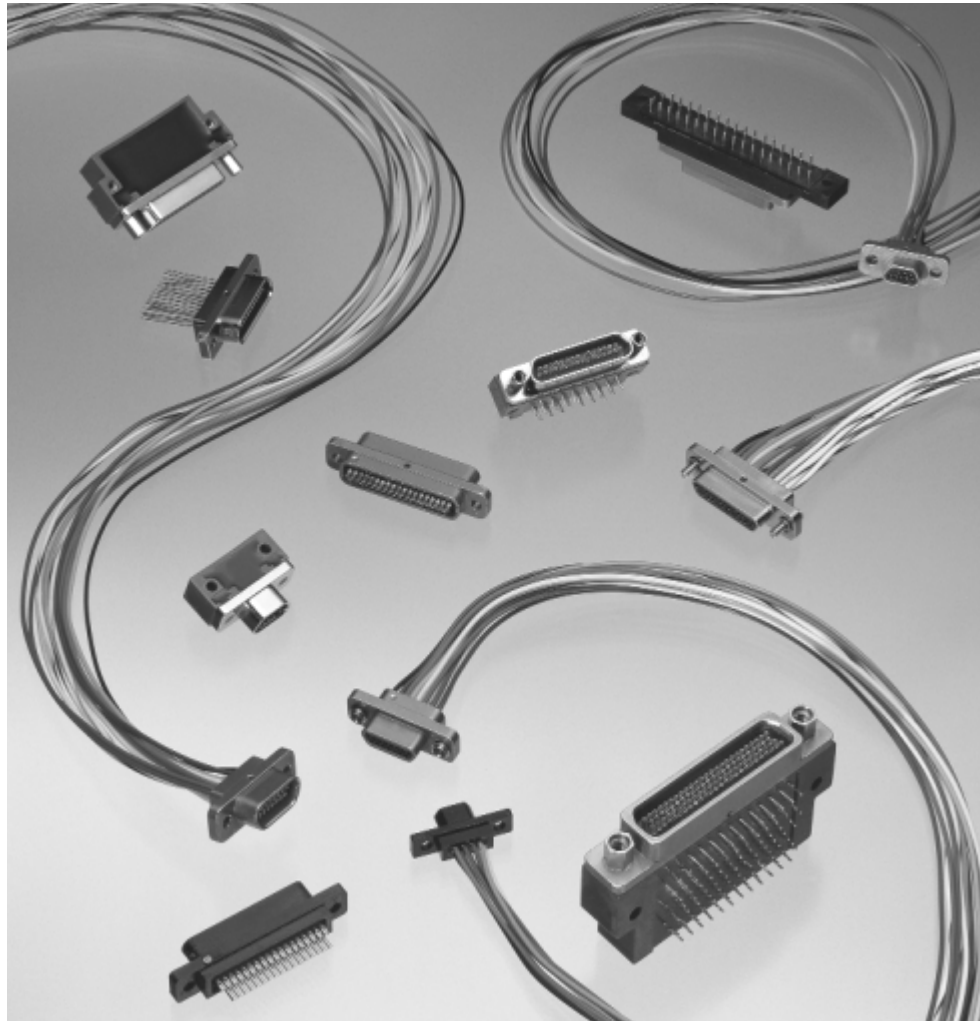

MICRODOT Connectors MCK and MCD High Density Microminiature "D" Connectors described in this catalog comprise a complete connector system, which is adaptable to a numerous variety of form factors. Low engaging force is achieved by the manner in which the twist pin contacts are designed. By constructing the male contact as a breathing helical spring, electrical contact is achieved at many points around the periphery of the pin bundle rather than at a few discrete points, as in conventional pin designs. Normal twist

pin engagement force is 6 oz. [1.67N] typically and 8 oz. [2.22N] maximum. The low force twist pins exhibit an engaging force of 4 oz. [1.11N] typically and 5 oz. [1.39N] maximum. Low force twist pins are standard in MIL-PRF-83513 configurations of MCK and MCD connectors and may be supplied as an option in all other configurations.

The MCK and MCD Series of connectors featured in this catalog are designed to meet the applicable requirements of MIL-PRF-83513, for intermateability, interchangeability, and

performance. Designed for both military and commercial applications, the MCK's and MCD's are especially well suited for use in miniaturized airborne and space electronics, computers, and test equipment. The metal shell MCK's and plastic shell MCD's are available with solder cup, and solid or stranded wire terminations. MCK transition blocks are standard for printed circuit board mounting. Custom termination configurations for both MCK and MCD can be accommodated. Micro D's are also supplied in wired harness assemblies.

Introduction

Product Facts

- Designed for both military and commercial applications
- Low engaging force is achieved by the manner in which Twist Pin Contacts are designed
- The metal shell and plastic shell are available with solder cup and solid or stranded wire terminations
- Mating force maximum is 10 oz. [2.78N] times the number of contacts
- Durability — No known mechanical or electrical issues detrimental to the function of the connectors after 500 cycles of mating and unmating
- Current Rating — 3 amps max per contact



MICRODOT Connectors MCK and MCD High Density Microminiature "D" Connectors described in this catalog comprise a complete connector system, which is adaptable to a numerous variety of form factors. Low engaging force is achieved by the manner in which the twist pin contacts are designed. By constructing the male contact as a breathing helical spring, electrical contact is achieved at many points around the periphery of the pin bundle rather than at a few discrete points, as in conventional pin designs. Normal twist

pin engagement force is 6 oz. [1.67N] typically and 8 oz. [2.22N] maximum. The low force twist pins exhibit an engaging force of 4 oz. [1.11N] typically and 5 oz. [1.39N] maximum. Low force twist pins are standard in MIL-PRF-83513 configurations of MCK and MCD connectors and may be supplied as an option in all other configurations.

The MCK and MCD Series of connectors featured in this catalog are designed to meet the applicable requirements of MIL-PRF-83513, for intermateability, interchangeability, and

performance. Designed for both military and commercial applications, the MCK's and MCD's are especially well suited for use in miniaturized airborne and space electronics, computers, and test equipment. The metal shell MCK's and plastic shell MCD's are available with solder cup, and solid or stranded wire terminations. MCK transition blocks are standard for printed circuit board mounting. Custom termination configurations for both MCK and MCD can be accommodated. Micro D's are also supplied in wired harness assemblies.

MCK/MCD/MCDM Series Metal and Plastic Shell Connectors

Technical and Performance Data

(Applicable to MCK, MCD and MCDM unless otherwise noted)

Electrical

Contacts — Pin 24 AWG twist pin, Socket 24 AWG precision machined barrel, Wire Range 24 AWG to 30 AWG solid and stranded.

Contact Resistance — (voltage drop) 25 millivolts max. at 3 amps, $77^{\circ} \pm 7.4^{\circ} \text{F}$ [$25^{\circ} \pm 3^{\circ} \text{C}$].

Current Rating — 3 amps max. per contact.

Dielectric Withstanding Voltage — Volts RMS 60 Hz at room ambient.

At sea level 600V solder pots, 800V wire terminations & transition blocks. At 70,000 ft. [21,336 m] 150V solder pots, 200V wire terminations & transition blocks.

Insulation Resistance — 5,000 megohms min. (@ 500 VDC) at ambient room temperature.

Magnetic Permeability — 2 mu max.

Mechanical

Contact Spacing — .050 [1.27mm] centers.

Contact Engagement & Separation — Standard contact engaging force is 6.0 oz. [1.67N] (8.0 oz. [2.22N] max.). Separation force is 0.5 [1.4N] oz. min.

Mating Force Maximum — Calculated as 10 oz. times the number of contacts.

Environmental

Temperature Range — -67°F to 257°F [-55°C to $+125^{\circ} \text{C}$] for MCK/MCD, -67°F to 302°F [-55°C to $+150^{\circ} \text{C}$] for MCDM.

Vibration — No discontinuity in excess of 1 μ sec. when tested in accordance with MIL-STD-1344, Method 2005, test Condition IV.

Solderability — Connectors shall pass the test requirements of MIL-STD-202, Method 208

Shock — No discontinuity in excess of 1 μ sec. when tested in accordance with MIL-STD-1344, Method 2004, test Condition E.

Durability — No mechanical or electrical defects detrimental to the function of the connectors after 500 cycles of mating and unmating.

Humidity — After exposure to humidity as specified by MIL-STD-1344, Method 1002, Type II, IR shall be 1 megohm min. following step 7a of Method 1002 and 1000 megohms min. after 24 hours of conditioning per Method 1002.

Salt Spray — Connectors shall meet the performance requirements of contact resistance, mating and unmating forces, and contact retention after being subjected to the 48-hour 5% solution salt spray test per MIL-STD-1344, Method 1001, Condition B.

Fluid Immersion — Unmated connectors after being fully immersed in one of the following fluids, for the prescribed time, will mate at a force of 10 oz. [2.78N] times the number of contacts or less: Perchloroethylene, 2 hours; Lubricating oil per MIL-L-23699, 20 hours.

Insert Retention — Inserts will withstand a 50 lb. [34N/cm²] per square inch load in either direction.

Crimp Termination Tensile Strength — (Unassembled contacts with crimped stranded wire terminations) Wires will not pull out of contacts when the following axial loads are applied: 24 AWG, 5 lbs. [22.24N]; 26 AWG, 4 lbs. [17.79N]; 28 AWG, 3 lbs. [13.34N]

Outgassing — When tested in accordance with SP-R-0022, Total Mass Loss (TML) shall be less than 1.0% and Volatile Condensable Material (VCM) shall be less than 0.1% of the original specimen.

Materials and Finishes

Contacts — Copper alloy plated with .000050 [0.00127] gold over copper flash per MIL-G-45204 Type II.

Hardware — see pages 5041 and 5042.

MCK-Metal Shell

Insulator — RYTON R4, Polyphenylene Sulfide per MIL-M-24519
 Interfacial Seal — Fluorosilicone Rubber per MIL-R-25988 (socket side only)
 Body Shell — Aluminum alloy—high grade plated
 Cadmium per QQ-P-416
 Nickel, electroless per AMS 2404

Transition Block Shell

RYTON R4, Polyphenylene Sulfide per MIL-M-24519
 Potting Material — Epoxy, Black

MCD-Plastic Shell

Insulator/Body — Polyester, glass filled per MIL-M-24519, Polyphenylene Sulfide per MIL-M-24519

Wire Terminations

Solid copper per QQ-W-343 gold plated per MIL-G-45204
 Stranded TEFLON insulated per MIL-W-16878
 Stranded TEFLON insulated per MIL-W-22759/11, /33
 Solid copper per QQ-W-343, solder dipped (Transition block)

MCDM-Metal Shell

Insulator — Diallyl Phthalate per MIL-M-14, Type SDG-F
 Body Shell — Aluminum alloy—high grade, nickel plated

Twist Pin, Pin and Socket Contacts

The contact spring member normally found in socket contacts has been eliminated by creating a breathing helical spring principle on the pin contact — smaller, more durable contacts can be manufactured economically.



Wire range 24-36 AWG solid & stranded.

MIL-PRF-83513 — Only the descriptive legend in bold italic is applicable to current MIL-PRF-83513 configurations; MIL-PRF-83513/1 through /4 — MCK metal shell; MIL-PRF-83513/6 through /9 — MCD plastic shell.

In addition, MIL-PRF-83513 solid copper wire termination is specified 25 AWG, 0.5; and 1.0 [25.4] lengths only and stranded insulated wire termination is specified 26 AWG, 18.0 [457.2] and 36.0 [914.4] lead lengths only. Hardware for MIL-PRF-83513 configurations is specified separately by the M83513/5-XX designation. M83513/1 through /4 and /6 through /9 specify no hardware (B). Mounting/mating hardware is shown on pages 5041 and 5042 with the applicable military nomenclature. The MICRODOT catalog part number for a MIL-PRF-83513 configuration may be constructed to include the desired hardware.

See pages 5058-5062 for M83513/ cross reference.

Metal Shell

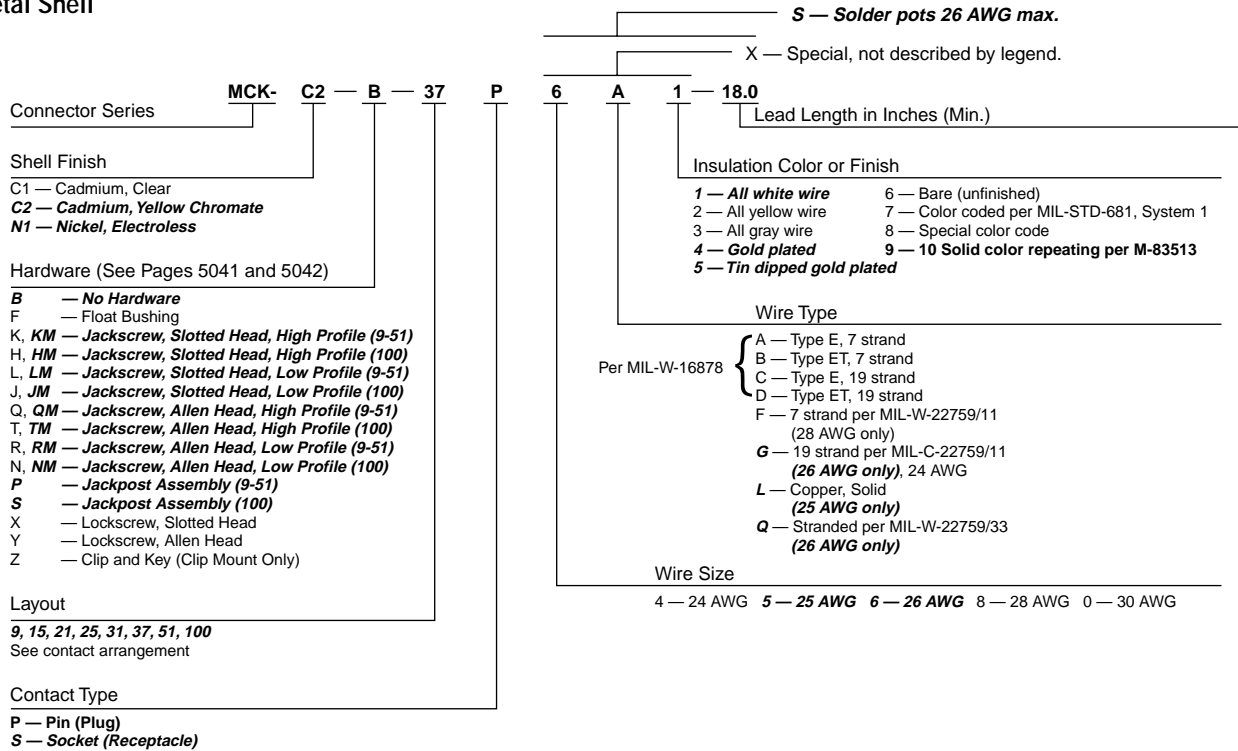

Plastic Shell

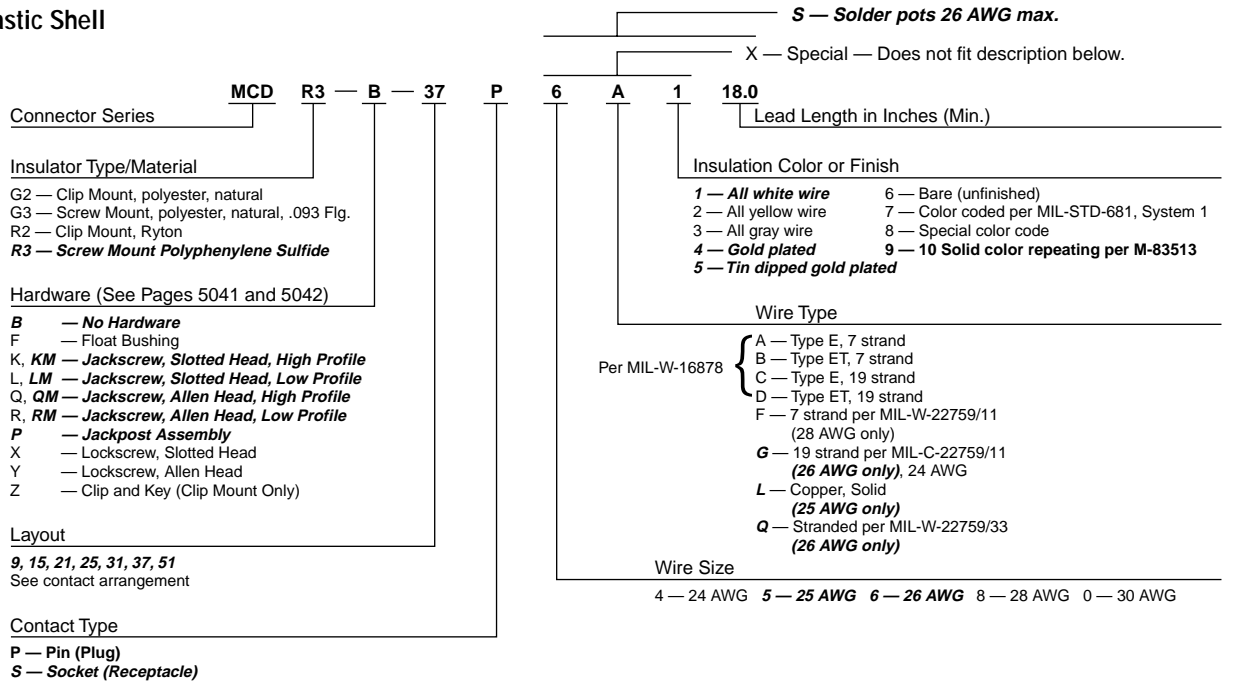

Note: Items in bold italic are qualified to MIL-PRF-83513.

Face View of Pin Insert
(Socket Side is Mirror Image)

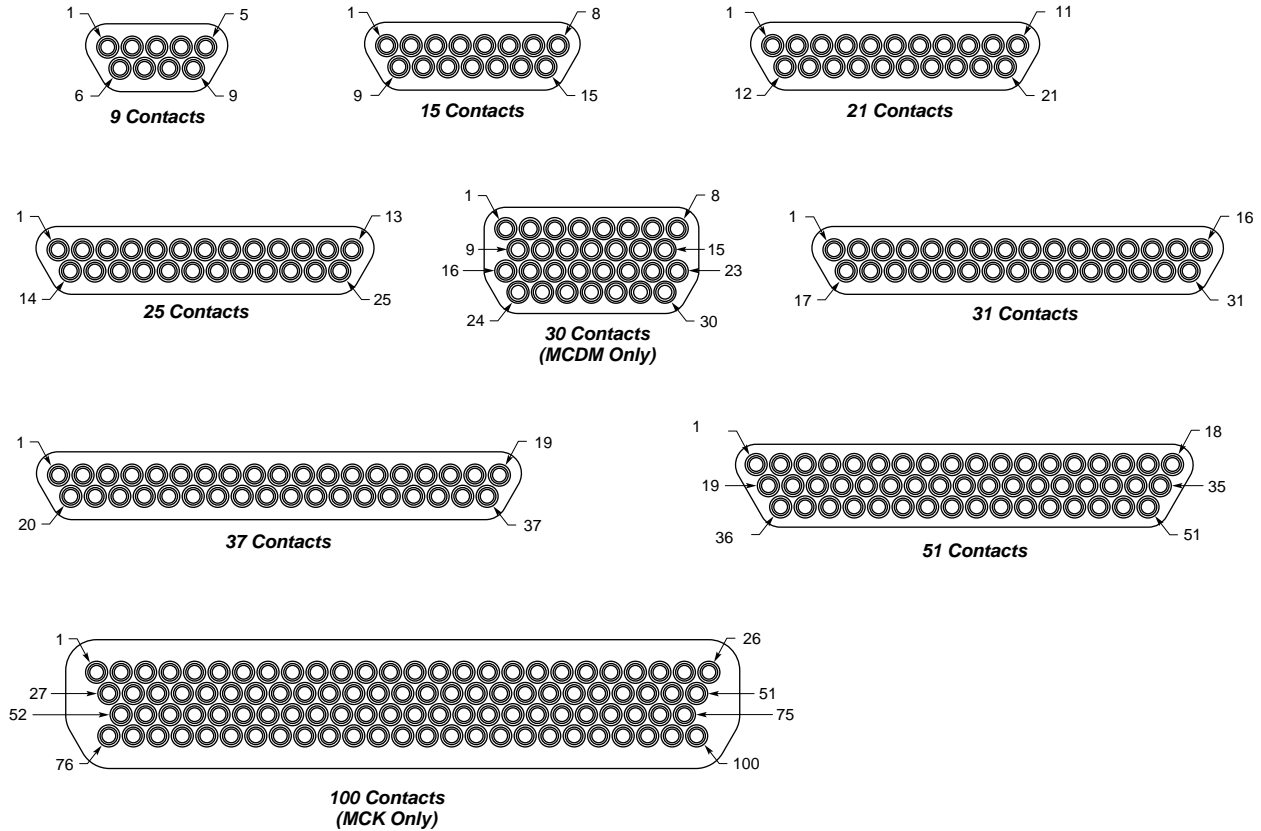

Note: MCK metal shells are not designed to intermate or interchange with MCD plastic shells. If metal/plastic intermating is desired, use MCDM Series Metal Shell on pages 5052 and 5053 with MCD Series Plastic Shell on page 5038.

MCK Series Metal Shell Connectors

Dimensions per MIL-PRF-83513



Plug
(Pin side)

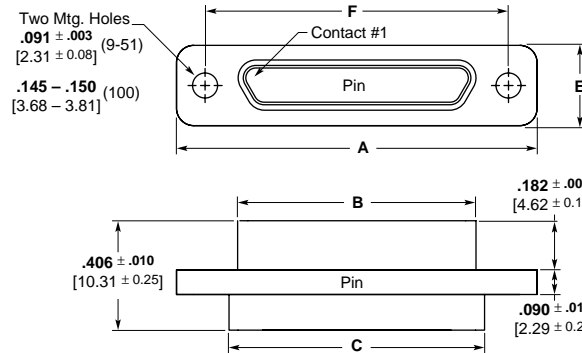

Crimp or Solder

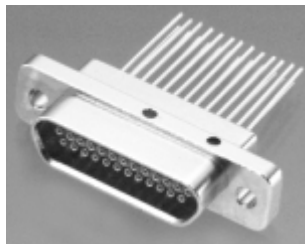
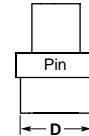

Receptacle
(Socket side)

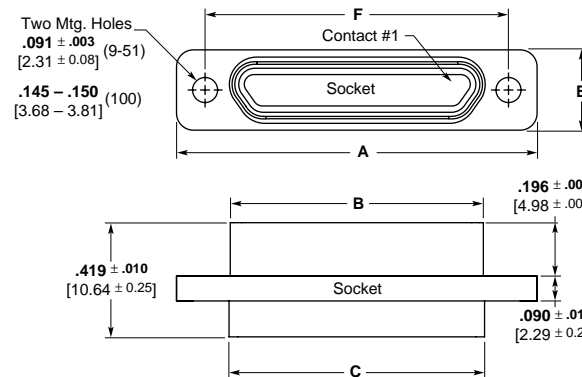

Crimp or Solder

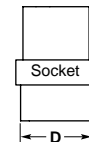

Part Number	A ± .010 [.254]	B Max.	C +.010 [.254] -.018 [.457]	D Max	E ±.010 [.254]	F ± .005 [.127]
MCK**- 9P***	.775 19.68	.333 8.46	.390 9.91	.270 6.86	.298 7.57	.565 14.35
MCK**- 9S***	.775 19.68	.402 10.22	.390 9.91	.270 6.86	.298 7.57	.565 14.35
MCK**- 15P***	.925 23.50	.483 12.27	.540 13.72	.270 6.86	.298 7.57	.715 18.16
MCK**- 15S***	.925 23.50	.552 14.03	.540 13.72	.270 6.86	.298 7.57	.715 18.16
MCK**- 21P***	1.075 27.30	.633 16.08	.690 17.53	.270 6.86	.298 7.57	.865 21.97
MCK**- 21S***	1.075 27.30	.702 17.84	.690 17.53	.270 6.86	.298 7.57	.865 21.97
MCK**- 25P***	1.175 29.84	.733 18.62	.790 20.07	.270 6.86	.298 7.57	.965 24.51
MCK**- 25S***	1.175 29.84	.802 20.38	.790 20.07	.270 6.86	.298 7.57	.965 24.51
MCK**- 31P***	1.325 33.66	.883 22.43	.940 23.88	.270 6.86	.298 7.57	1.115 28.32
MCK**- 31S***	1.325 33.66	.952 24.19	.940 23.88	.270 6.86	.298 7.57	1.115 28.32
MCK**- 37P***	1.475 37.46	1.033 26.24	1.090 27.69	.270 6.86	.298 7.57	1.265 32.13
MCK**- 37S***	1.475 37.46	1.102 28.00	1.090 27.69	.270 6.86	.298 7.57	1.265 32.13
MCK**- 51P***	1.425 36.20	.983 24.97	1.040 26.42	.310 7.87	.341 8.66	1.215 30.86
MCK**- 51S***	1.425 36.20	1.052 26.73	1.040 26.42	.310 7.87	.341 8.66	1.215 30.86
MCK**- 100P***	2.160 54.86	1.383 35.13	1.432 36.37	.360 9.15	.384 9.75	1.800 45.71
MCK**- 100S***	2.160 54.86	1.508 38.31	1.432 36.37	.360 9.15	.384 9.75	1.800 45.71

P = Pin, S = Socket

Panel Mounting Dimensions — MCK

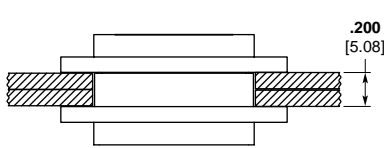

Plug and Receptacle Rear Mounted

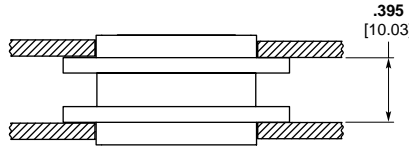

Plug and Receptacle Front Mounted

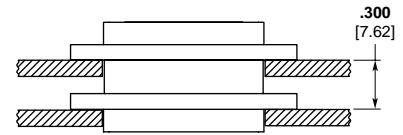

Plug Front Mounted Receptacle Rear Mounted

Panel Cutout Dimensions — MCK

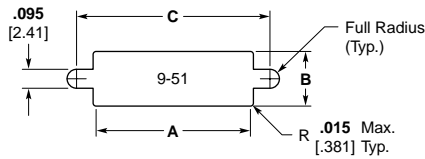

Figure 1 Front Mounting

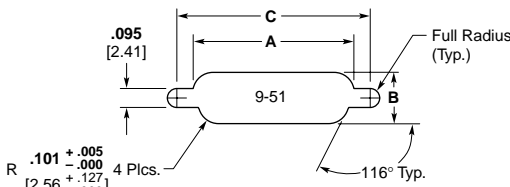
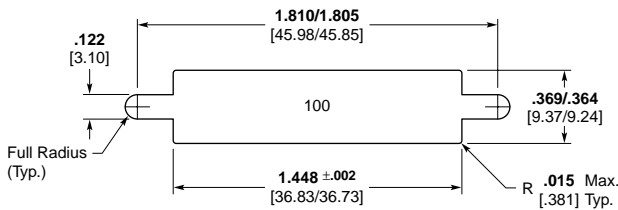
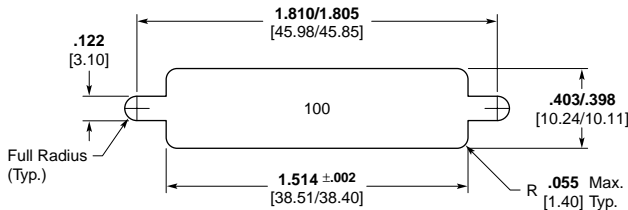

Figure 2 Rear Mounting



Front Mounting



Rear Mounting

Number of Contacts	Fig.	A + .004 [.102] - .000 [.000]	B + .004 [.102] - .000 [.000]	C + .005 [.127] - .000 [.000]
9	1	.404 10.26	.274 6.96	.570 14.48
	2	.406 10.31	.257 6.53	.570 14.48
15	1	.554 14.07	.274 6.96	.720 18.29
	2	.556 14.12	.257 6.53	.720 18.29
21	1	.704 17.88	.274 6.96	.870 22.10
	2	.706 17.93	.257 6.53	.870 22.10
25	1	.804 20.42	.274 6.96	.970 24.64
	2	.806 20.47	.257 6.53	.970 24.64
31	1	.954 24.23	.274 6.96	1.120 28.45
	2	.956 24.28	.257 6.53	1.120 28.45
37	1	1.104 28.04	.274 6.96	1.270 32.26
	2	1.106 28.09	.257 6.53	1.270 32.26
51	1	1.054 26.77	.314 7.98	1.220 30.99
	2	1.056 26.82	.300 7.62	1.220 30.99

MCD Series Plastic Shell Connectors

Screw Mount Dimensions Per MIL-PRF-83513

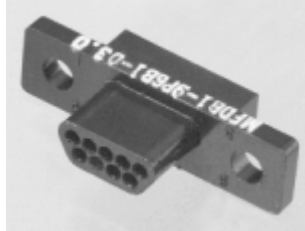

Plug (Pin side)

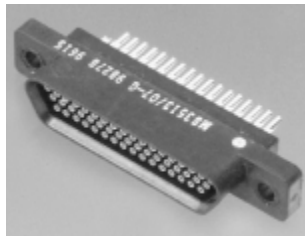

Receptacle (Socket side)

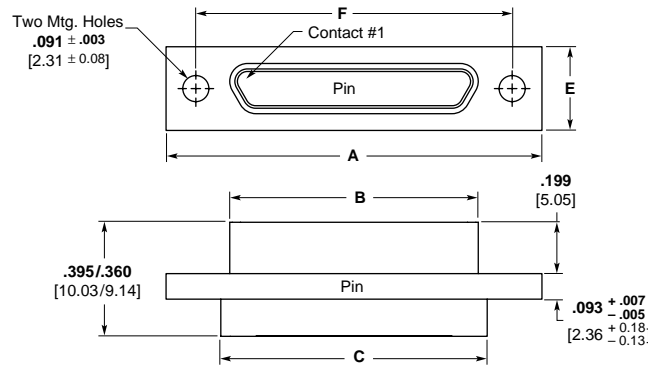

Crimp or Solder

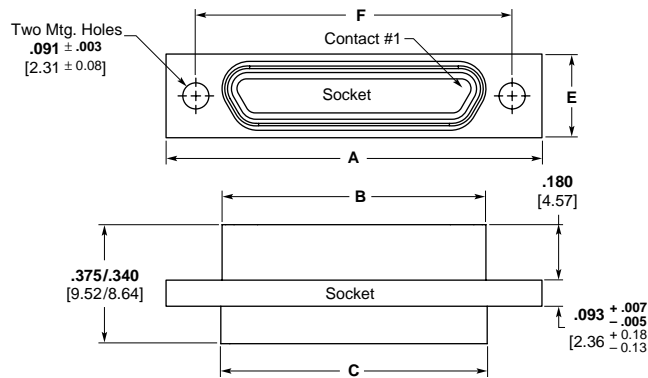
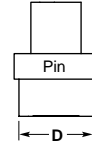

Crimp or Solder

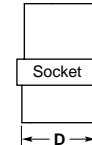

Polyphenylene Sulfide (RYTON) — MCDR3* per MIL-PRF-83513

Note: MCD Plastic Screw Mount Series is interchangeable with MCDM Metal Series Connectors (Pages 5052 and 5053).

Part Number	A ± .010 [.254]	B Max.	C +.010 [.254] / -.018 [.457]	D Max	E ±.010 [.254]	F ± .005 [.127]	Avg. Weight lbs. ± 5% [grams]
MCD**- 9P***	.788 20.02	.2918 7.412	.398 10.11	.173 4.39	.208 5.28	.565 14.35	.0017 0.77
MCD**- 9S***	.788 20.02	.3798 9.647	.398 10.11	.173 4.39	.208 5.28	.565 14.35	.0016 0.72
MCD**- 15P***	.938 23.83	.4418 11.222	.548 13.92	.173 4.39	.208 5.28	.715 18.16	.0024 1.08
MCD**- 15S***	.938 23.83	.5298 13.457	.548 13.92	.173 4.39	.208 5.28	.715 18.16	.0023 1.04
MCD**- 21P***	1.088 27.64	.5918 15.032	.698 17.73	.173 4.39	.208 5.28	.865 21.97	.0035 1.59
MCD**- 21S***	1.088 27.64	.6798 17.267	.698 17.73	.173 4.39	.208 5.28	.865 21.97	.0034 1.54
MCD**- 25P***	1.188 30.18	.6918 17.572	.798 20.27	.173 4.39	.208 5.28	.965 24.51	.0042 1.90
MCD**- 25S***	1.188 30.18	.7798 19.807	.798 20.27	.173 4.39	.208 5.28	.965 24.51	.0037 1.67
MCD**- 31P***	1.338 33.99	.8418 21.382	.948 24.08	.173 4.39	.208 5.28	1.115 28.32	.0053 2.40
MCD**- 31S***	1.338 33.99	.9298 23.617	.948 24.08	.173 4.39	.208 5.28	1.115 28.32	.0048 2.17
MCD**- 37P***	1.488 37.80	.9918 25.192	1.098 27.89	.173 4.39	.208 5.28	1.265 32.13	.0057 2.58
MCD**- 37S***	1.488 37.80	1.0798 27.427	1.098 27.89	.173 4.39	.208 5.28	1.265 32.13	.0051 2.31
MCD**- 51P***	1.438 36.53	.9418 23.922	1.048 26.62	.220 5.59	.250 6.35	1.215 30.86	.0072 3.26
MCD**- 51S***	1.438 36.53	1.0298 26.157	1.048 26.62	.220 5.59	.250 6.35	1.215 30.86	.0063 2.85

P = Pin, S = Socket

Note: Weight given is with .500 [12.7] uninsulated, solid, 24 AWG gold plated copper pigtailed.

*See "How to Specify" for description, on page 5034.

MCD Series Plastic Shell Connectors (Continued)

Clip Mount — MCD



Plug
(Pin side)

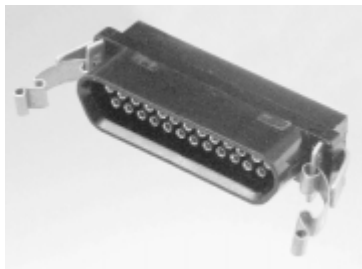

Receptacle
(Socket side)

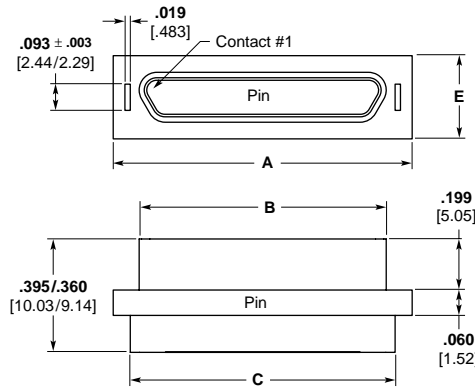

Crimp or Solder

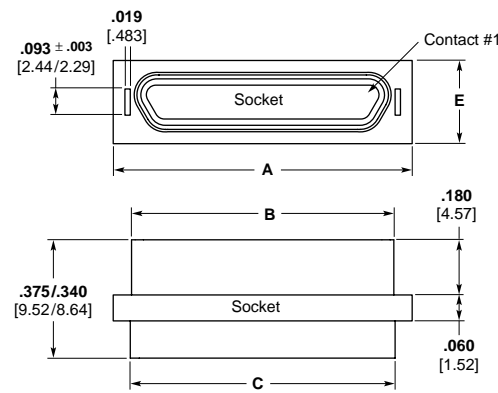
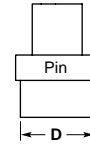

Crimp or Solder

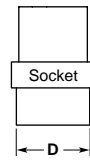

Note: Clip Mount not covered by current issue of MIL-PRF-83513.

Part Number	A ±.005 [.127]	B Max.	C +.010 [.254]	D ±.010 (.254)	E ±.005 [.127]	Avg. Weight lbs. ± 5% [grams]
MCD**- 9P***	.506 12.85	.2918 74.12	.398 10.11	.165 4.19	.208 5.28	.0017 0.77
MCD**- 9S***	.506 12.85	.3798 96.47	.398 10.11	.165 4.19	.208 5.28	.0016 0.72
MCD**- 15P***	.656 16.66	.4418 112.22	.548 13.92	.165 4.19	.208 5.28	.0024 1.08
MCD**- 15S***	.656 16.66	.5298 134.57	.548 13.92	.165 4.19	.208 5.28	.0023 1.04
MCD**- 21P***	.806 20.47	.5918 150.32	.698 17.73	.165 4.19	.208 5.28	.0035 1.59
MCD**- 21S***	.806 20.47	.6798 172.67	.698 17.73	.165 4.19	.208 5.28	.0034 1.54
MCD**- 25P***	.906 23.01	.6918 175.72	.798 20.27	.165 4.19	.208 5.28	.0042 1.90
MCD**- 25S***	.906 23.01	.7798 198.07	.798 20.27	.165 4.19	.208 5.28	.0037 1.67
MCD**- 31P***	1.056 26.82	.8418 213.82	.948 24.08	.165 4.19	.208 5.28	.0053 2.40
MCD**- 31S***	1.056 26.82	.9298 236.17	.948 24.08	.165 4.19	.208 5.28	.0048 2.17
MCD**- 37P***	1.206 30.63	.9918 251.92	1.098 27.89	.165 4.19	.208 5.28	.0057 2.58
MCD**- 37S***	1.206 30.63	1.0798 274.27	1.098 27.89	.165 4.19	.208 5.28	.0051 2.31
MCD**- 51P***	1.156 29.36	.9418 239.22	1.048 26.62	.208 5.28	.250 6.35	.0072 3.26
MCD**- 51S***	1.156 29.36	1.0298 261.57	1.048 26.62	.208 5.28	.250 6.35	.0063 2.85

P = Pin, S = Socket

Note: Weight given is with .500 [12.7] uninsulated, solid, 24 AWG gold plated copper pigtails.

*See "How to Specify" for description, on page 5034.

Panel Mounting Dimensions — MCD

Clip Mount

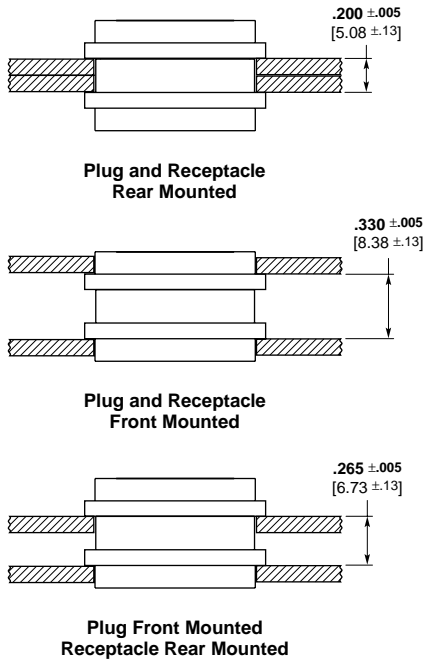

Screw Mount

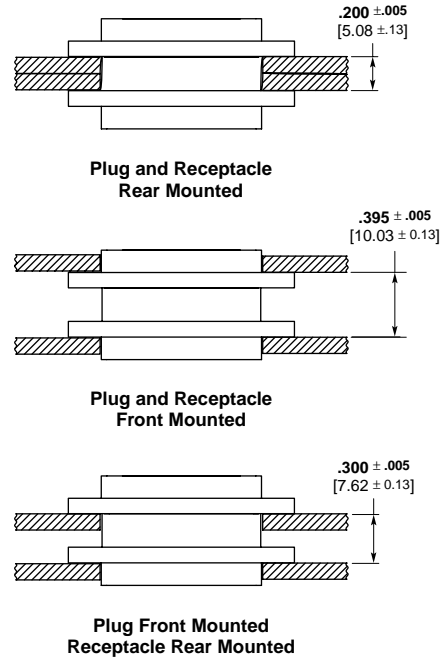

Panel Cutout Dimensions — MCD

Clip Mounting

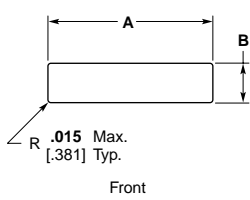

Figure 1

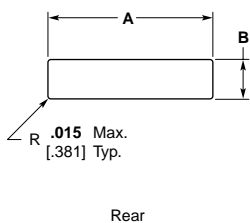

Figure 3

Screw Mounting

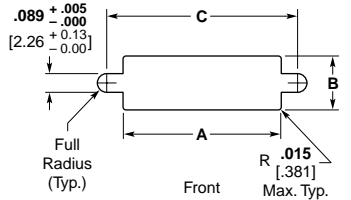

Figure 2

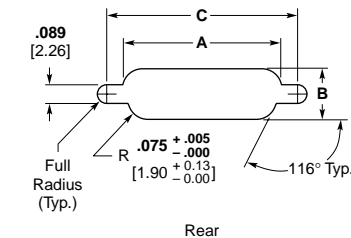

Figure 4

Notes: Front mounting preferred.

Items in bold italic are qualified to MIL-PRF-83513.

Number of Contacts	Fig.	A		B		C	
		+ .004 [.102]	-.000 [.000]	+ .004 [.102]	-.000 [.000]	+ .005 [.127]	-.000 [.000]
9	1	.438	[11.13]	.177	[4.50]	—	—
	2	.412	[10.46]	.177	[4.50]	.570	[14.48]
	3	.438	[11.13]	.222	[5.64]	—	—
	4	.384	[9.75]	.222	[5.64]	.570	[14.48]
15	1	.588	[14.93]	.177	[4.50]	—	—
	2	.562	[14.27]	.177	[4.50]	.720	[18.29]
	3	.588	[14.93]	.222	[5.64]	—	—
	4	.534	[13.56]	.222	[5.64]	.720	[18.29]
21	1	.738	[18.75]	.177	[4.50]	—	—
	2	.712	[18.08]	.177	[4.50]	.870	[22.10]
	3	.738	[18.75]	.222	[5.64]	—	—
	4	.684	[17.37]	.222	[5.64]	.870	[22.10]
25	1	.838	[21.29]	.177	[4.50]	—	—
	2	.812	[20.62]	.177	[4.50]	.970	[24.64]
	3	.838	[21.29]	.222	[5.64]	—	—
	4	.784	[19.91]	.222	[5.64]	.970	[24.64]
31	1	.988	[25.10]	.177	[4.50]	—	—
	2	.962	[24.43]	.177	[4.50]	1.120	[28.45]
	3	.988	[25.10]	.222	[5.64]	—	—
	4	.934	[23.72]	.222	[5.64]	1.120	[28.45]
37	1	1.138	[28.91]	.177	[4.50]	—	—
	2	1.112	[28.24]	.177	[4.50]	1.270	[32.26]
	3	1.138	[28.91]	.222	[5.64]	—	—
	4	1.084	[27.53]	.222	[5.64]	1.270	[32.26]
51	1	1.088	[27.64]	.224	[5.69]	—	—
	2	1.062	[26.97]	.224	[5.69]	1.220	[30.99]
	3	1.088	[27.64]	.264	[6.71]	—	—
	4	1.034	[26.26]	.264	[6.71]	1.220	[30.99]

For Screw Mount MCK,
MCD and MCDM

9-51 Contacts
Slot Head

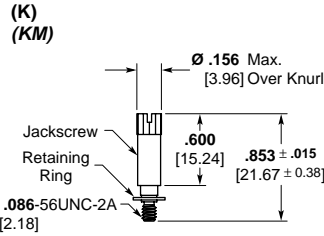

Part Number 5-1532137-8
Jackscrew Assembly
High Profile
(K) 096-0002-0010
M83513/5-06
(KM) S96-0002-0084

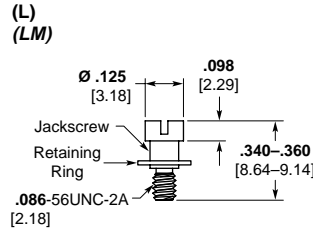

Part Number 5-1532137-7
Jackscrew Assembly
Low Profile
(L) 096-0002-0011
M83513/5-05
(LM) S96-0002-0085

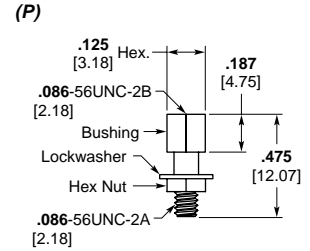

Part Number 5-1532137-9
Jackpost Assembly
(P) S96-0002-0009
M83513/5-07

P mates with K,KM, L,LM, Q,QM and R,RM Jackscrew Assemblies.

9-51 Contacts
1/16" Allen Head

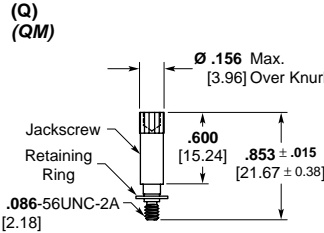

Part Number 5-1532137-6
Jackscrew Assembly
High Profile
(Q) 096-0002-0014
M83513/5-03
(QM) S96-0002-0086

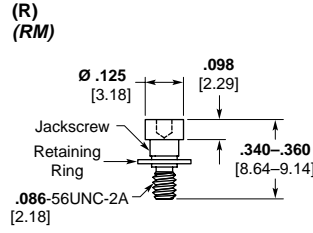

Part Number 5-1532137-5
Jackscrew Assembly
Low Profile
(R) 096-0002-0015
M83513/5-02
(RM) S96-0002-0087

Notes:

- Jackpost Assemblies will accommodate .094 [2.39] max. thickness panel.
- Letter(s) in parentheses is to assist in ordering hardware with the connector (See "How To Specify" page 5034).
- Single letters (e.g. K) designate hardware kits (2 pcs. per kit) that meets M83513/05 requirements except the material is 303 stainless steel, passivated.
- Add M suffix (e.g. KM) to designate hardware that meets all M83513/05 requirements. Material is corrosion resistant steel, non-magnetic, 125,000 PSI tensile strength minimum (Applies to jackscrews only).
- Non-MIL hardware ordered separately should be ordered in pairs; i.e. 2 pcs. P/N 096-0002-0009 per connector half.
- Items in bold italic are qualified to MIL-PRF-83513.**

100 Contacts
Slot Head

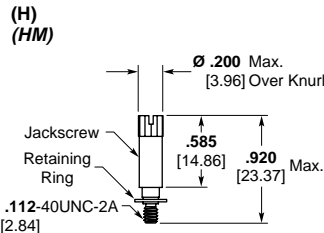

Part Number 6-1532137-3
Jackscrew Assembly
High Profile
(H) 096-0002-0061
M83513/5-16
(HM) S96-0002-0088

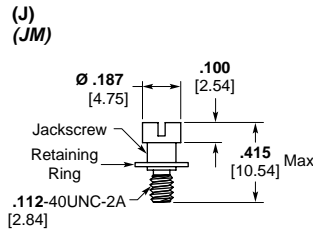

Part Number 6-1532137-2
Jackscrew Assembly
Low Profile
(J) 096-0002-0062
M83513/5-15
(JM) S96-0002-0089

100 Contacts
1/16" Allen Head

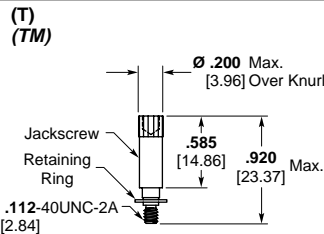

Part Number 6-1532137-1
Jackscrew Assembly
High Profile
(T) 096-0002-0064
M83513/5-13
(TM) S96-0002-0090

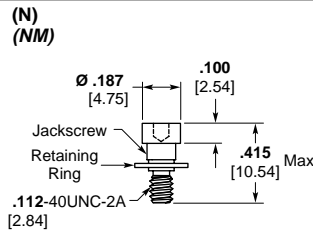

Part Number 6-1532137-0
Jackscrew Assembly
Low Profile
(N) 096-0002-0065
M83513/5-12
(NM) S96-0002-0091

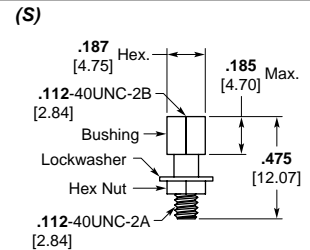

Part Number 6-1532137-4
Jackpost Assembly
(S) S96-0002-0060
M83513/5-17

S mates with H,HM, J,JM, T,TM and N,NM Jackscrew Assemblies.

Mounting and Coupling Hardware (Continued)

For Screw Mount MCK,
MCD and MCDM (Continued)

Slot Head
(X)

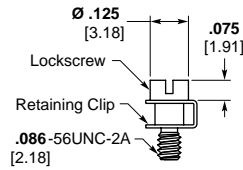

Part Number 4-1532137-3
Lockscrew Assembly
096-0002-0008

1/16" Allen Head
(Y)

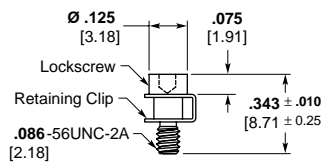

Part Number 1495164-1
Lockscrew Assembly
096-0002-0013

For Clip Mount — MCD

(Z)

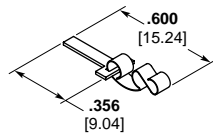

Part Number 1466018-1
Mounting Key and Clip
P/N 096-0001-0000
(2 Required)

For Float Mount — MCK,
MCD and MCDM

(F)

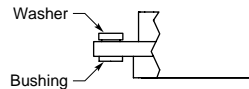

Float Mount Bushing
(Factory Installed)

Notes:

1. Jackpost Assemblies will accommodate .094 [2.39] max. thickness panel.
2. Letter(s) in parentheses is to assist in ordering hardware with the connector (See "How To Specify" page 5034).
3. Hardware ordered separately should be ordered in pairs; i.e. 2 pcs. P/N 096-0002-0013 per connector half.

MCK Transition Blocks

RT1 — Right-Angle Termination Configuration

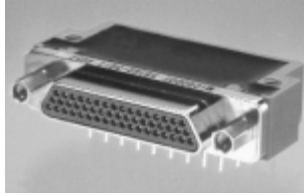

MIL-PRF-83513/10 through /21 configurations. 90° — Lo Profile termination configurations.
See pages 5061 & 5062 for M83513/cross references.

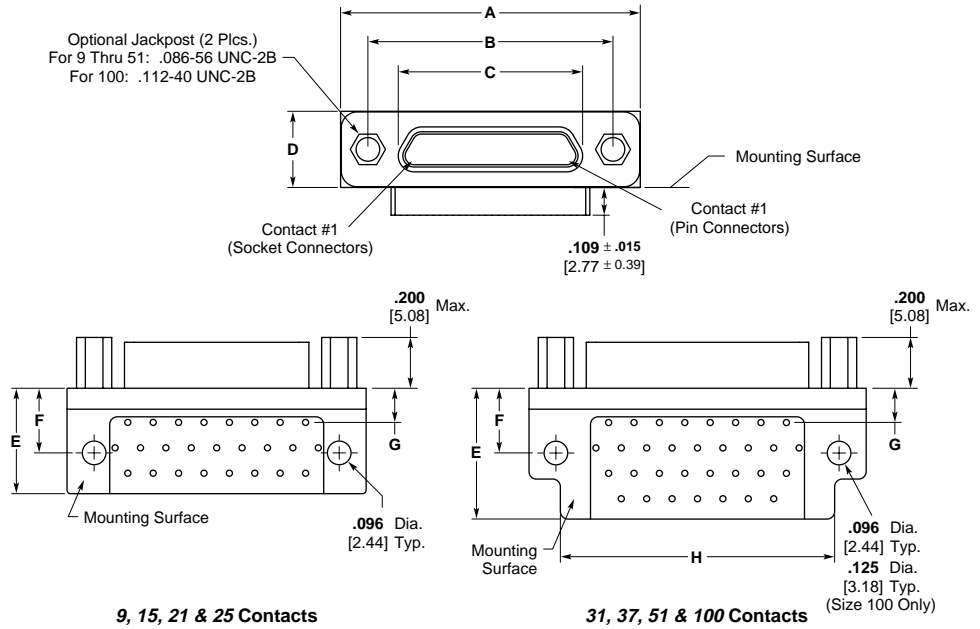

How To Specify

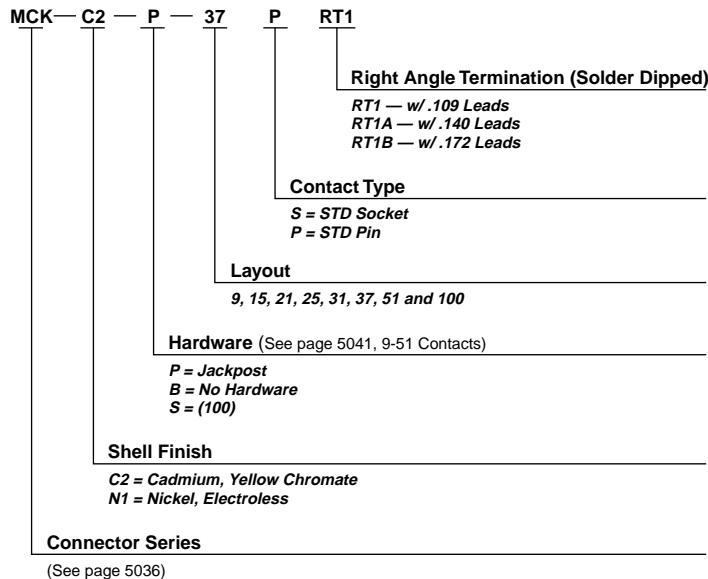

Notes:

1. For terminal identification see page 5045.
2. Grid pattern for all configurations is .100 x .100 [2.54 x 2.54].
3. Wire lengths shown are for RT1.
4. **Items in bold italic are qualified to MIL-PRF-83513.**

RT1 — Right-Angle Termination Configuration

(Continued)

Part Number	A Max.	B ± 005 [.127]	C Max.	D Max.	E Max.	F +.010 [.254]	G +.010 [.254]	H Max.
<i>MCK-**-*- 9PRTI</i>	.785 19.94	.565 14.35	.333 8.46	.308 7.83	.420 10.67	.250 6.35	.230 5.84	—
<i>MCK-**-*- 9SRTI</i>	.785 19.94	.565 14.35	.402 10.22	.308 7.83	.420 10.67	.250 6.35	.230 5.84	—
<i>MCK-**-*- 15PRTI</i>	.935 23.75	.715 18.16	.483 12.27	.308 7.83	.420 10.67	.250 6.35	.130 3.30	—
<i>MCK-**-*- 15SRTI</i>	.935 23.75	.715 18.16	.552 14.03	.308 7.83	.420 10.67	.250 6.35	.130 3.30	—
<i>MCK-**-*- 21PRTI</i>	1.085 27.56	.865 21.97	.633 16.08	.308 7.83	.420 10.67	.250 6.35	.130 3.30	—
<i>MCK-**-*- 21SRTI</i>	1.085 27.56	.865 21.97	.702 17.84	.308 7.83	.420 10.67	.250 6.35	.130 3.30	—
<i>MCK-**-*- 25PRTI</i>	1.185 30.10	.965 24.51	.733 18.62	.308 7.83	.420 10.67	.250 6.35	.130 3.30	—
<i>MCK-**-*- 25SRTI</i>	1.185 30.10	.965 24.51	.802 20.38	.308 7.83	.420 10.67	.250 6.35	.130 3.30	—
<i>MCK-**-*- 31PRTI</i>	1.335 33.91	1.115 28.32	.883 22.43	.308 7.83	.520 13.21	.250 6.35	.130 3.30	1.085 27.56
<i>MCK-**-*- 31SRTI</i>	1.335 33.91	1.115 28.32	.952 24.19	.308 7.83	.520 13.21	.250 6.35	.130 3.30	1.085 27.56
<i>MCK-**-*- 37PRTI</i>	1.485 37.72	1.265 32.13	1.033 26.24	.308 7.83	.520 13.21	.250 6.35	.130 3.30	1.185 30.10
<i>MCK-**-*- 37SRTI</i>	1.485 37.72	1.265 32.13	1.102 28.00	.308 7.83	.520 13.21	.250 6.35	.130 3.30	1.185 30.10
<i>MCK-**-*- 51PRTI</i>	1.435 36.45	1.215 30.86	.983 24.97	.351 8.92	.650 16.51	.300 7.62	.150 3.81	1.225 31.88
<i>MCK-**-*- 51SRTI</i>	1.435 36.45	1.215 30.86	1.052 26.73	.351 8.92	.650 16.51	.300 7.62	.150 3.81	1.225 31.88
<i>MCK-**-*- 100PRTI</i>	2.170 55.12	1.800 45.72	1.383 35.13	.394 10.01	1.000 25.40	.400 10.16	.200 5.08	1.815 46.11
<i>MCK-**-*- 100SRTI</i>	2.170 55.12	1.800 45.72	1.508 38.31	.394 10.01	1.000 25.40	.400 10.16	.200 5.08	1.815 46.11

P = Pin, S = Socket

Note: Items in bold italic are qualified to MIL-PRF-83513.

RT1 — Right-Angle Termination Configuration

(Continued)

View is from mounting surface of connector. Plug configuration shown. For receptacle, use mirror image. (Except 100 contacts)

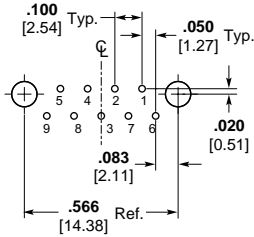

9 Contacts

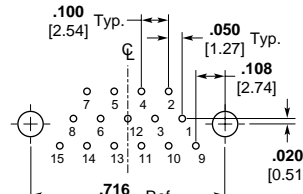

15 Contacts

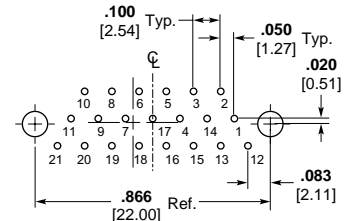

21 Contacts

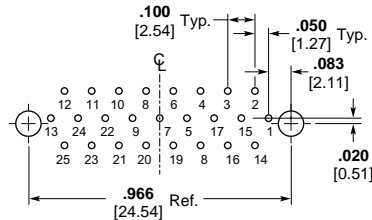

25 Contacts

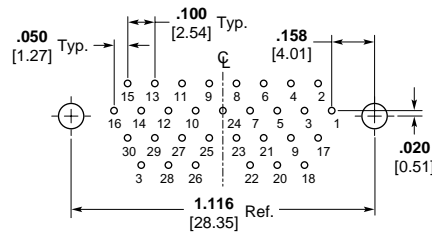

31 Contacts

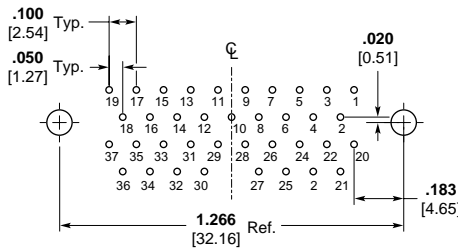

37 Contacts

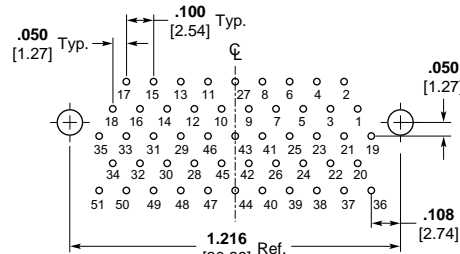

51 Contacts

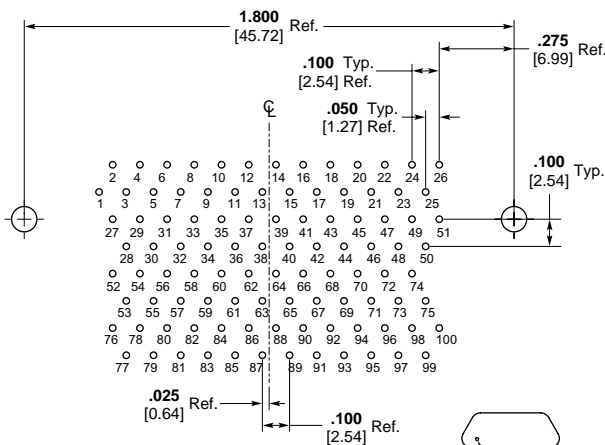

100 Contacts (Socket Connector)

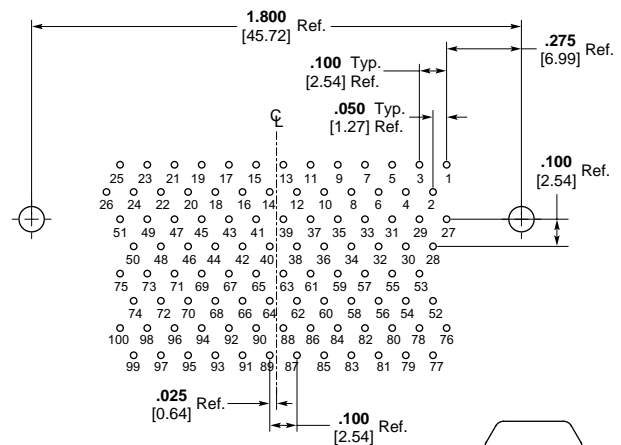
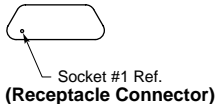

100 Contacts (Pin Connector)

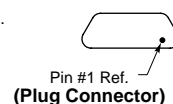

MCK Transition Blocks (Continued)

ST1 — Straight Termination Configuration

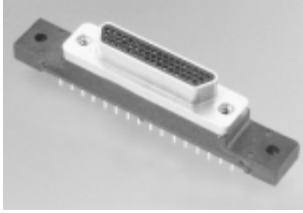

MIL-PRF-83513/22 through /27 configurations. 180° — Lo Profile termination configurations. See page 5062 for M83513/cross references.

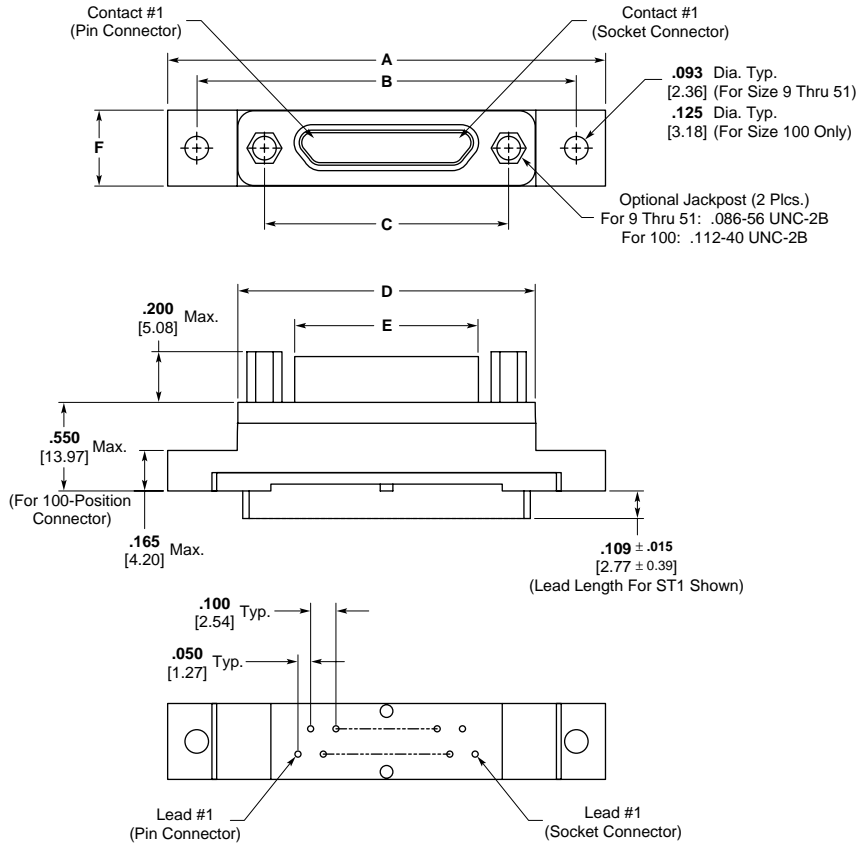

How To Specify

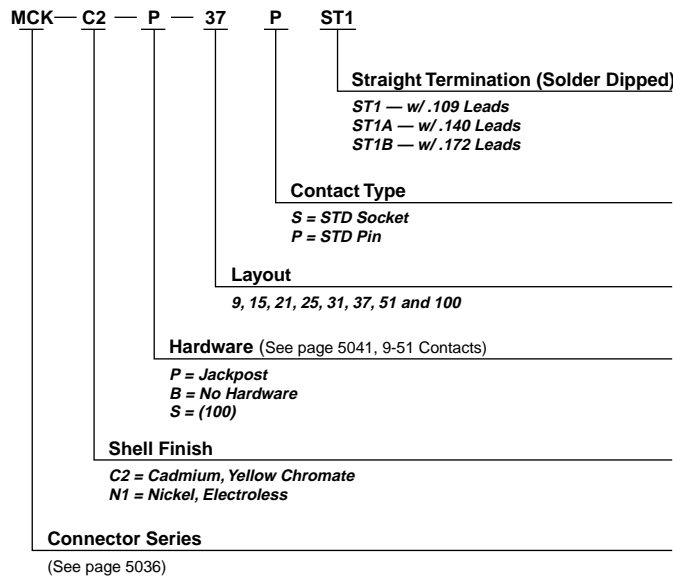

Notes:

1. For terminal identification see page 5048.
2. Grid pattern for all configurations is .100 x .100 [2.54 x 2.54].
3. Wire lengths shown are for ST1.
4. **Items in bold italic are qualified to MIL-PRF-83513.**

ST1 — Straight Termination Configuration (Continued)

Part Number	A Max.	B ± .005 [.127]	C ± .005 [.127]	D Max.	E Max.	F Max.
<i>MCK-**-*- 9PSTI</i>	1.390 35.31	1.150 29.21	.565 14.35	.785 19.94	.333 8.46	.308 7.83
<i>MCK-**-*- 9SSTI</i>	1.390 35.31	1.150 29.21	.565 14.35	.785 19.94	.402 10.22	.308 7.83
<i>MCK-**-*- 15PSTI</i>	1.390 35.31	1.150 29.21	.715 18.16	.935 23.75	.483 12.27	.308 7.83
<i>MCK-**-*- 15SSTI</i>	1.390 35.31	1.150 29.21	.715 18.16	.935 23.75	.552 14.03	.308 7.83
<i>MCK-**-*- 21PSTI</i>	1.690 42.93	1.450 36.83	.865 21.97	1.085 27.56	.633 16.08	.308 7.83
<i>MCK-**-*- 21SSTI</i>	1.690 42.93	1.450 36.83	.865 21.97	1.085 27.56	.702 17.84	.308 7.83
<i>MCK-**-*- 25PSTI</i>	1.740 44.20	1.500 38.10	.965 24.51	1.185 30.10	.733 18.62	.308 7.83
<i>MCK-**-*- 25SSTI</i>	1.740 44.20	1.500 38.10	.965 24.51	1.185 30.10	.802 20.38	.308 7.83
<i>MCK-**-*- 31PSTI</i>	2.040 51.82	1.800 45.72	1.115 28.32	1.335 33.91	.883 22.43	.308 7.83
<i>MCK-**-*- 31SSTI</i>	2.040 51.82	1.800 45.72	1.115 28.32	1.335 33.91	.952 24.19	.308 7.83
<i>MCK-**-*- 37PSTI</i>	2.340 59.44	2.100 53.34	1.265 32.13	1.485 37.72	1.033 26.24	.308 7.83
<i>MCK-**-*- 37SSTI</i>	2.340 59.44	2.100 53.34	1.265 32.13	1.485 37.72	1.102 28.00	.308 7.83
<i>MCK-**-*- 51PSTI</i>	2.270 57.66	2.000 50.80	1.215 30.86	1.435 36.45	.983 24.97	.351 8.92
<i>MCK-**-*- 51SSTI</i>	2.270 57.66	2.000 50.80	1.215 30.86	1.435 36.45	1.052 26.73	.351 8.92
<i>MCK-**-*- 100PSTI</i>	3.070 77.98	2.800 71.12	1.800 45.72	2.170 55.12	1.383 35.13	.394 10.01
<i>MCK-**-*- 100SSTI</i>	3.070 77.98	2.800 71.12	1.800 45.72	2.170 55.12	1.508 38.31	.394 10.01

P = Pin, S = Socket

Note: Items in bold italic are qualified to MIL-PRF-83513.

MCK Transition Blocks (Continued)

ST1 — Straight Termination Configuration (Continued)

View is from mounting surface of connector. Plug configuration shown. For receptacle, use mirror image.

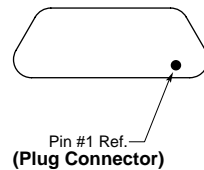
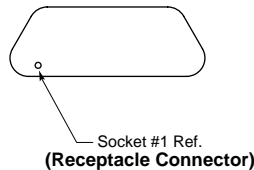
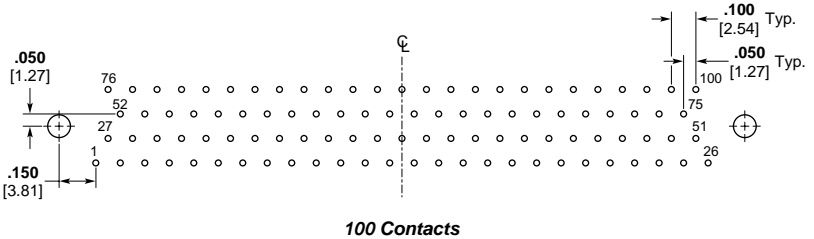
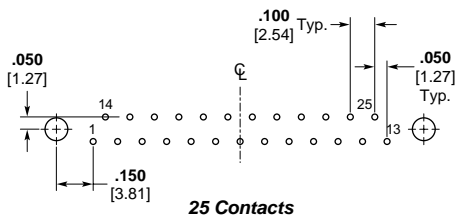
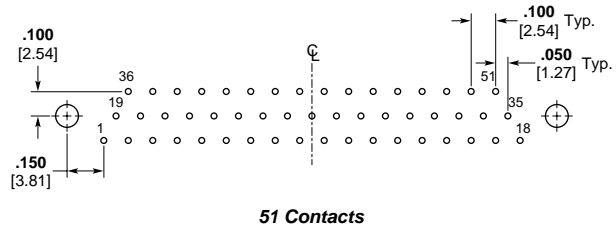
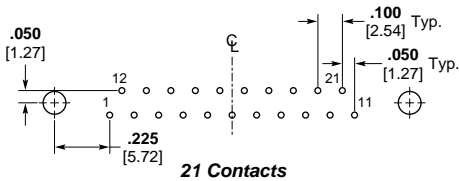
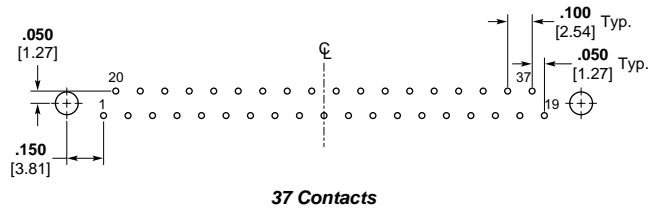
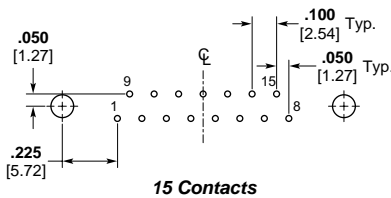
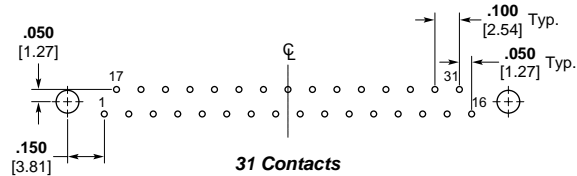
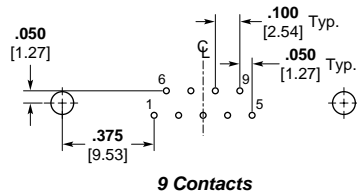

MCK ST2 Series Straight Mount PCB Connectors

MCK with Cactus Bend Termination

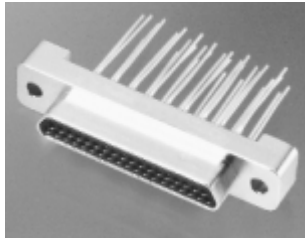

- Meets MIL-PRF-83513 Performance
- Single metal shell with no Transition Block
- Low profile and light weight
- .100 [2.54] x .075 [1.91] grid pattern
- Design allows lower cost construction

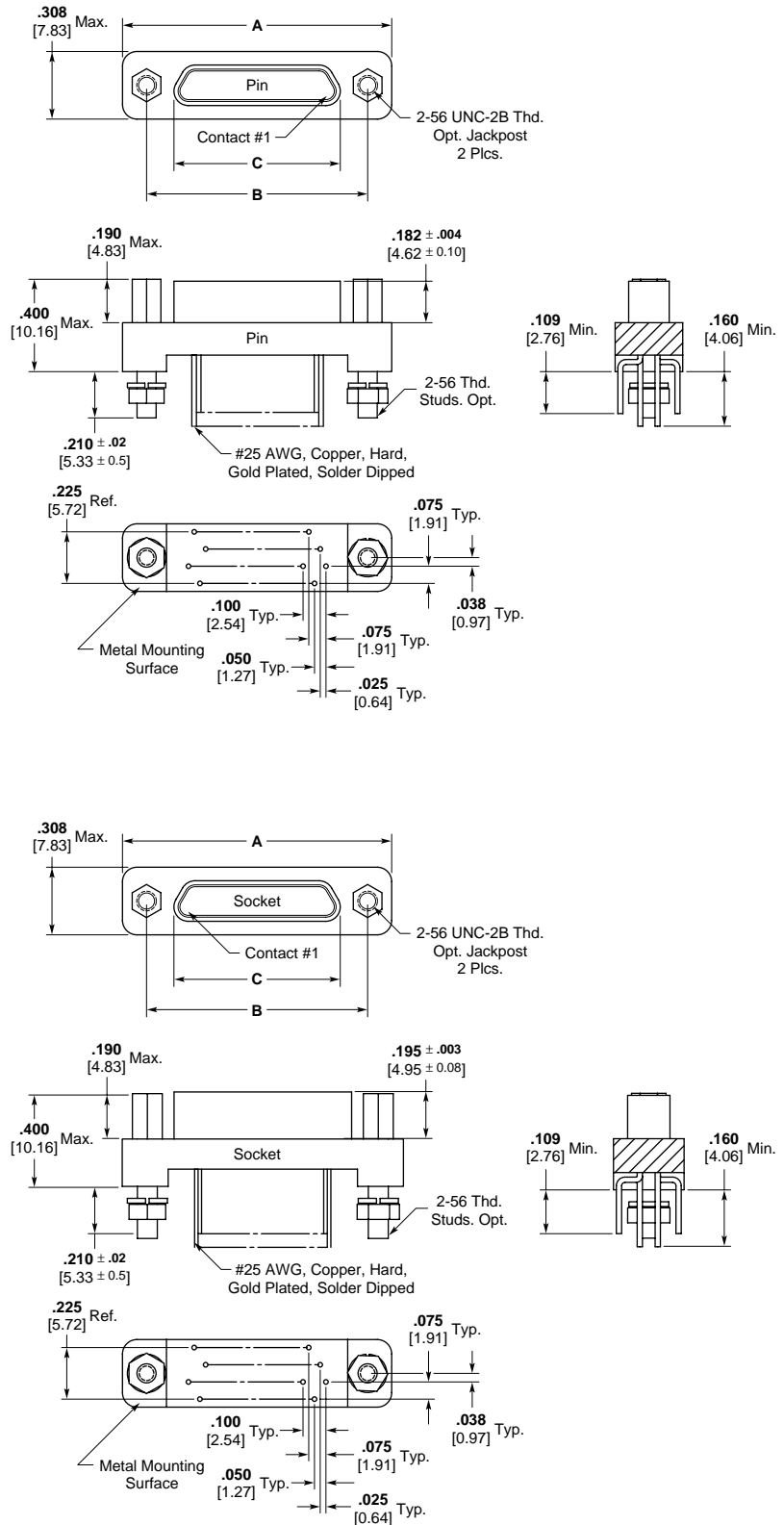

5 Pin and Socket Connectors

MCK ST2 Series Straight Mount PCB Connectors (Continued)

Part Number	A Max.	B ± .005	C Max.
MCK-**-*- 9 PST2	.785 19.94	.565 14.35	.333 8.46
MCK-**-*- 9 SST2	.785 19.94	.565 14.35	.402 10.21
MCK-**-*- 15 PST2	.935 23.75	.715 18.16	.483 12.27
MCK-**-*- 15 SST2	.935 23.75	.715 18.16	.552 14.02
MCK-**-*- 21 PST2	1.085 27.56	.865 21.97	.633 16.08
MCK-**-*- 21 SST2	1.085 27.56	.865 21.97	.702 17.83
MCK-**-*- 25 PST2	1.185 30.10	.965 24.51	.733 18.62
MCK-**-*- 25 SST2	1.185 30.10	.965 24.51	.802 20.37
MCK-**-*- 31 PST2	1.335 33.91	1.115 28.32	.883 22.43
MCK-**-*- 31 SST2	1.335 33.91	1.115 28.32	.952 24.18
MCK-**-*- 37 PST2	1.485 37.72	1.265 32.13	1.033 26.24
MCK-**-*- 37 SST2	1.485 37.72	1.265 32.13	1.102 27.99

How To Specify

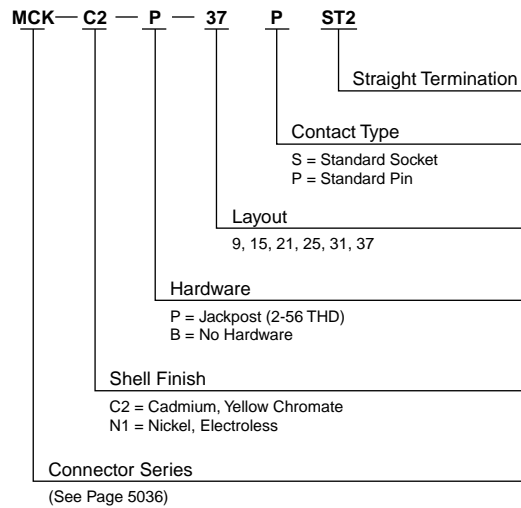

View is of mounting surface of pin connector

View is of mounting surface of socket connector

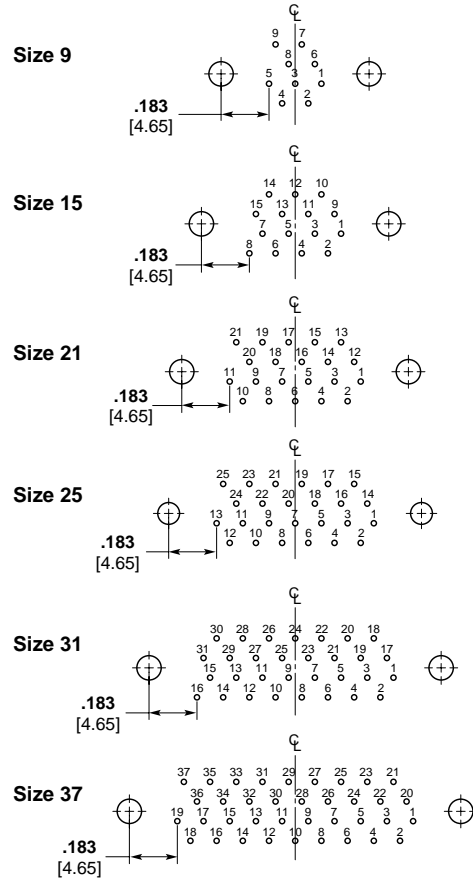
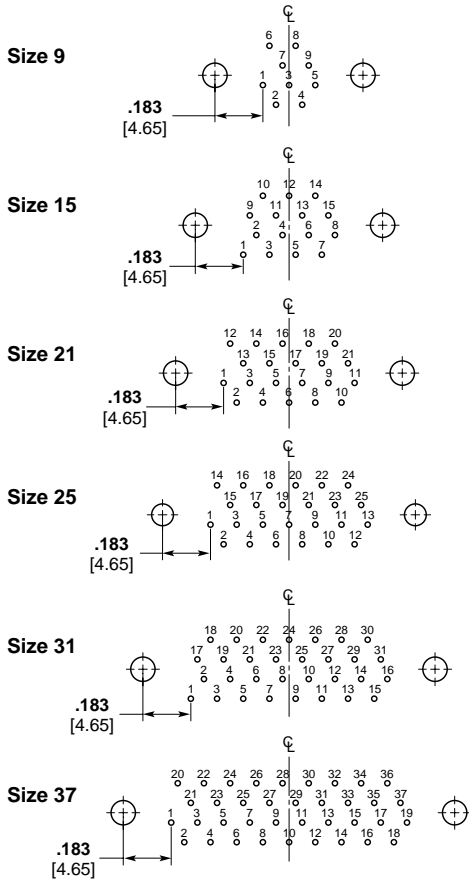

5
Pin and Socket Connectors

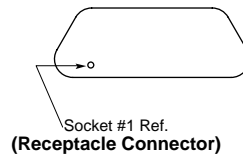
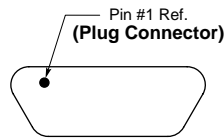

Technical & Performance Data

Performance

Contact Resistance — The average mated contact resistance is 4 milliohms, with a maximum value of 8 milliohms, using standard #24 solid copper leads when measured directly behind the crimp joints of the mated pin and socket contacts. The average resistance value at 100 microvolts is 4.8 milliohms.

Dielectric Withstanding Voltage (60 Hz rms room temperature) — 750 VAC at sea level; 200 VAC at 70,000 feet [21,336 m].

Vibration (Per MIL-STD-202C, Method 204-A, Condition D) — No discontinuity in excess of 1 microsecond during twelve 20 minute sweeps from 10 to 2,000 CPS at .06 double amplitude or 20 G forces, whichever is less.

Corrosion Resistance (Per MIL-STD-202C, Method 101B, Condition B) — Both mated and unmated samples do not exceed the

maximum allowable contact resistance (8 milliohms) when subjected to the 48 hour salt spray test.

Durability — The contact resistance after 500 mating cycles is less than the maximum allowable, 8 milliohms.

Insulation Resistance — Greater than 5,000 megohms at room temperature for the materials listed under "Materials".

Maximum Current Carrying Capacity — No. 24 contact, 3 amperes. It must be recognized, however, that all the wires to a connector will not carry their maximum current under all environmental conditions due to wire temperature.

Contact Engaging and Separation Forces — 6 oz. [1.67N] maximum (eng.); 0.5 oz. [.14N] minimum (sep.).

Temperature Range (Operating) — Diallyl phthalate -67°F to 257°F [-55°C to +125°C].

Materials

Insulator — Diallyl phthalate per MIL-M-14, Type SDG-F.

Contacts — Pin Contact: Copper alloy and beryllium copper alloy make up the complete construction. Socket Contact: Copper alloy.

Body Shell — High grade aluminum alloy.

Finishes

Contacts — Standard finish is 0.000050 [0.00127] gold over copper flash per MIL-G-45204, Type II.

Body Shell — Electroless nickel per AMS 2404.

Note:

Insulators are molded into their metal shells — No bonded joint is used.

Screw Mount

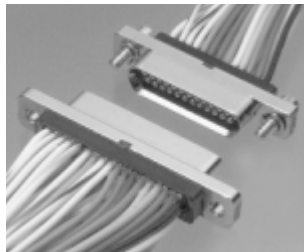

The only metal shell connector that mates with all existing plastic types. This line is ideal for external use and other applications requiring frequent disconnect and remating. When durability and reliability are paramount the metal shell connector is unsurpassed — it eliminates the need for retrofitting where new metal shell varieties must mate with older plastic types.

Originally designed for military applications, they are currently used for commercial requirements, including computers.

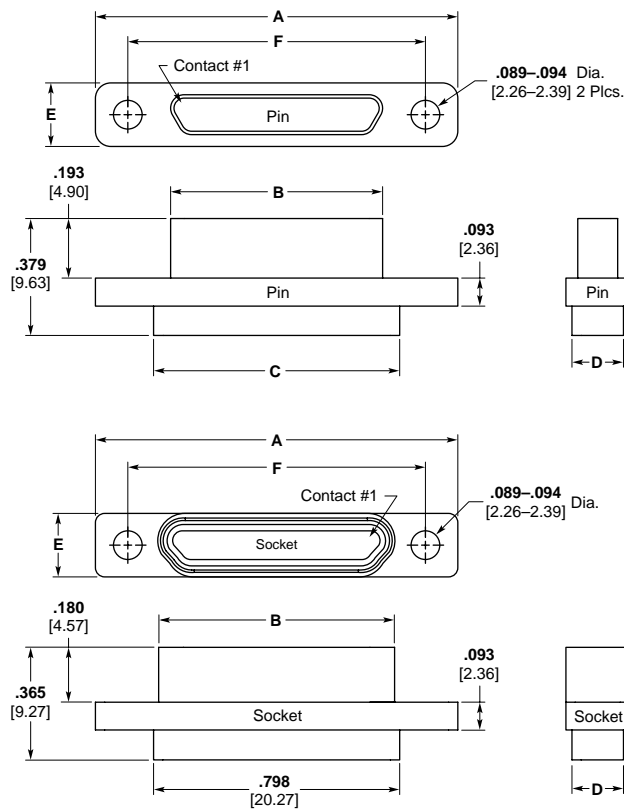

MCDM Series Metal Shell Connectors (Continued)

Screw Mount (Continued)

How To Specify

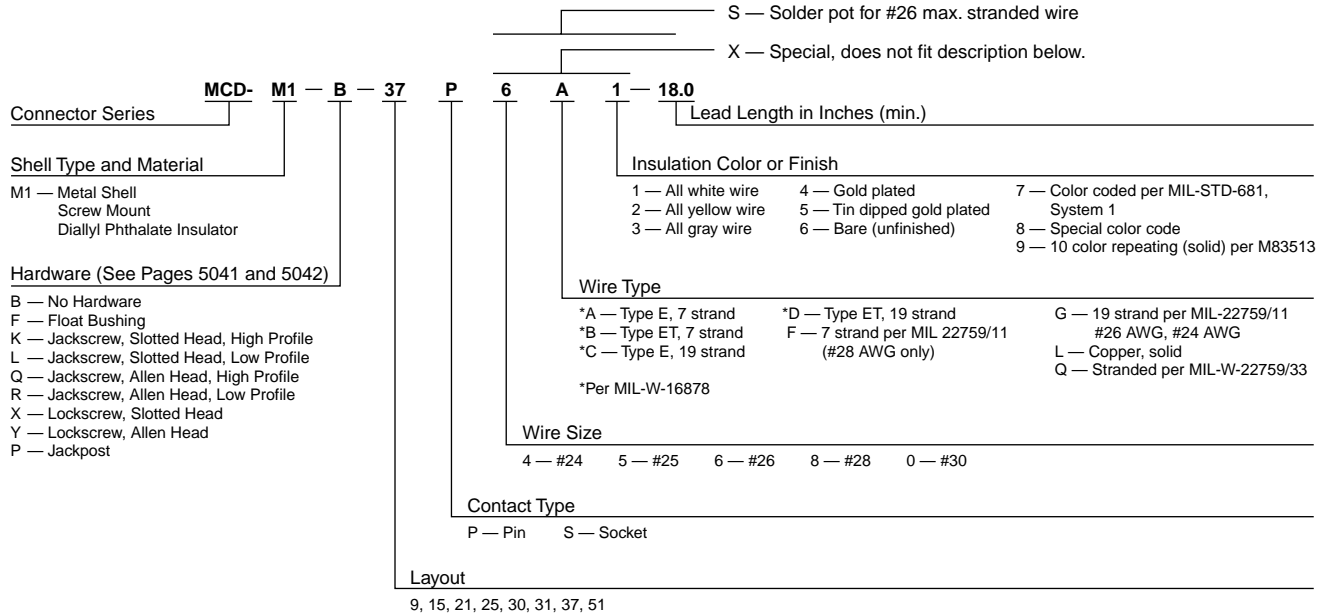

Part Number	A ± .005 [±.127]	B ± .005 [±.127]	C ± .010 [±.254]	D ± .010 [±.254]	E ± .005 [±.127]	F ± .005 [±.127]	Avg. Weight lbs. ± 5% [grams]
MCDM1-9P***	.780 19.81	.290 7.36	.398 10.11	.165 4.19	.208 5.28	.565 14.35	.003 1.36
MCDM1-9S***	.780 19.81	.365 9.27	.398 10.11	.165 4.19	.208 5.28	.565 14.35	.003 1.36
MCDM1-15P***	.930 23.62	.440 11.18	.548 13.92	.165 4.19	.208 5.28	.715 18.16	.004 1.81
MCDM1-15S***	.930 23.62	.515 13.08	.548 13.92	.165 4.19	.208 5.28	.715 18.16	.004 1.81
MCDM1-21P***	1.080 27.43	.590 14.99	.698 17.73	.165 4.19	.208 5.28	.865 21.97	.005 2.26
MCDM1-21S***	1.080 27.43	.665 16.89	.698 17.73	.165 4.19	.208 5.28	.865 21.97	.005 2.26
MCDM1-25P***	1.180 29.97	.690 17.53	.798 20.27	.165 4.19	.208 5.28	.965 24.51	.006 2.72
MCDM1-25S***	1.180 29.97	.765 19.43	.798 20.27	.165 4.19	.208 5.28	.965 24.51	.005 2.26
MCDM1-30P***	.930 23.62	.435 11.05	.548 13.92	.252 6.40	.295 7.49	.715 18.16	.007 3.17
MCDM1-30S***	.930 23.62	.515 13.08	.548 13.92	.252 6.40	.295 7.49	.715 18.16	.007 3.17
MCDM1-31P***	1.330 33.78	.840 21.34	.948 16.46	.165 4.19	.208 5.28	1.115 28.32	.007 3.17
MCDM1-31S***	1.330 33.78	.915 23.24	.948 16.46	.165 4.19	.208 5.28	1.115 28.32	.006 2.72
MCDM1-37P***	1.480 37.59	.990 25.15	1.098 27.89	.165 4.19	.208 5.28	1.270 32.26	.007 3.17
MCDM1-37S***	1.480 37.59	1.065 27.05	1.098 27.89	.165 4.19	.208 5.28	1.270 32.26	.007 3.17
MCDM1-51P***	1.430 36.32	.940 23.88	1.048 26.62	.208 5.28	.250 6.35	1.215 30.86	.009 4.08
MCDM1-51S***	1.430 36.32	1.015 25.78	1.048 26.62	.208 5.28	.250 6.35	1.215 30.86	.008 3.62

Note: Weight given is with .500 [12.7] uninsulated, solid, 24 AWG gold plated copper pigtailed.

MCDM Series Metal Shell RF COMBOMATE Connectors

Screw Mount Coaxial Terminations

Available *now* — RF Performance in standard subminiature rectangular connectors, with VSWR values of 1.01 to 1.10 in frequencies ranging in DC to 2.3 GHz. This is the COMBOMATE Connector.

This series of connectors incorporates the same metal shells and twist pin contacts used in the widely accepted, high reliability, MCDM Series.

The RF COMBOMATE Connector Series will accommodate RG 196 A/U or RG 178 B/U coaxial cable terminated in a unique, already tooled insert layouts. This feature results in savings in cost, time and space.

The RF COMBOMATE Connector Series will accommodate a maximum of 17 RG 196 A/U or RG 178 B/U cables in an area of less than .225 sq. inches [14.51 mm²]. Mixed layouts with coaxial terminations and standard AWG 24, 26 and 28 are also immediately available in 7 different shell sizes. The overall envelope and mounting dimensions of equivalent size of COMBOMATE Connectors are exactly the same as the standard MCDM Series.

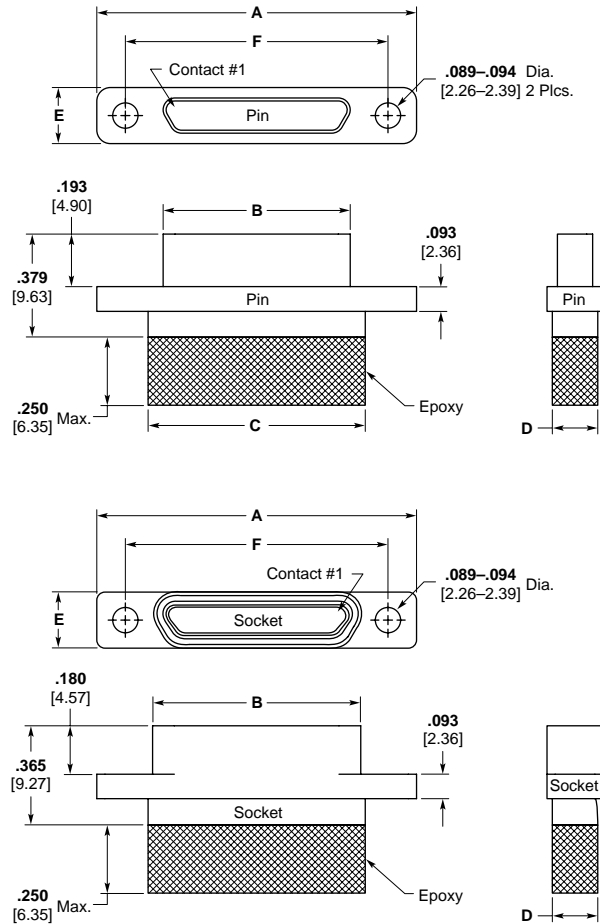

Performance Data — Coaxial Terminations

Impedance — 49.0 to 51.0 Ohms.

Voltage Standing Wave Ratio (VSWR) — 1.01:1 to 1.10:1 at frequency ranging in DC to 2.3 GHz.

Dielectric Withstanding Voltage (60 Hz rms room temperature) — 750 VAC at sea level; 200 VAC at 70,000 feet [21,336 m].

	(Actual Test Data) Crosstalk (Between Adjacent Lines)			
	1 to 2	2 to 3	3 to 4	4 to 5
30 MHz	60.0 db	59.8 db	60.7 db	60.0 db
100 MHz	49.1 db	48.3 db	51.7 db	50.6 db
175 MHz	42.6 db	41.4 db	47.2 db	47.0 db
500 MHz	38.0 db	38.8 db	39.5 db	40.0 db
1000 MHz	31.6 db	32.0 db	30.0 db	32.5 db
2000 MHz	22.4 db	22.5 db	22.3 db	20.8 db
3000 MHz	21.5 db	23.9 db	21.4 db	24.2 db

Sample	Insertion Loss				
	#1	#2	#3	#4	#5
30 MHz	.08 db	.08 db	.08 db	.08 db	.08 db
100 MHz	.24 db	.24 db	.25 db	.25 db	.25 db
175 MHz	.35 db	.36 db	.36 db	.34 db	.32 db
500 MHz	.58 db	.50 db	.60 db	.58 db	.48 db
1000 MHz	1.25 db	1.33 db	1.36 db	1.35 db	1.24 db
2000 MHz	1.48 db	1.71 db	1.42 db	1.40 db	1.45 db
3000 MHz	2.66 db	2.45 db	2.74 db	2.86 db	2.84 db

Note: Verification of all test data is on file at Tyco Electronics and is available upon request. All test runs using RG 196 A/U.

MCDM Series Metal Shell RF COMBOMATE Connectors (Continued)

Screw Mount Coaxial Terminations (Continued)

How To Specify

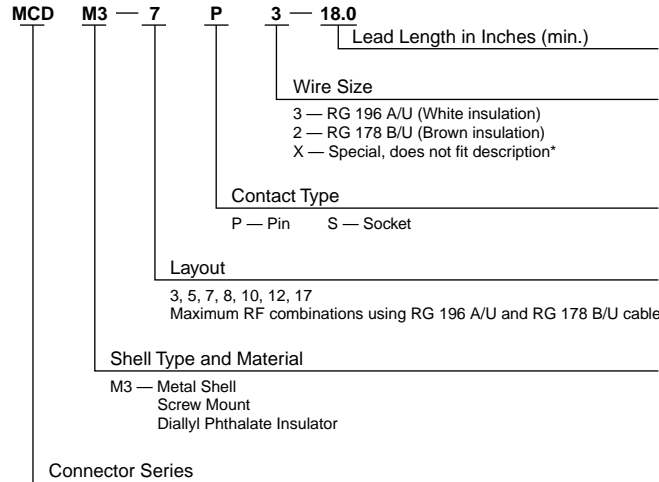

*Ordering Criteria: A wide variety of contact combinations, coaxial and power mixed, are available. Contact Tyco Electronics for additional arrangement numbers.

Part Number	A ± .005 [± .127]	B ± .005 [± .127]	C Max.	D Max.	E ± .005 [± .127]	F ± .005 [± .127]
MCDM3-3P**	.780 19.81	.290 7.36	.408 10.36	.200 5.08	.208 5.28	.565 14.35
MCDM3-3S**	.780 19.81	.365 9.27	.408 10.36	.200 5.08	.208 5.28	.565 14.35
MCDM3-5P**	.930 23.62	.440 11.18	.558 14.17	.200 5.08	.208 5.28	.715 18.16
MCDM3-5S**	.930 23.62	.515 13.08	.558 14.17	.200 5.08	.208 5.28	.715 18.16
MCDM3-7P**	1.080 27.43	.590 14.99	.708 17.98	.200 5.08	.208 5.28	.865 21.97
MCDM3-7S**	1.080 27.43	.665 16.89	.708 17.98	.200 5.08	.208 5.28	.865 21.97
MCDM3-8P**	1.180 29.97	.690 17.53	.808 20.52	.200 5.08	.208 5.28	.965 24.51
MCDM3-8S**	1.180 29.97	.765 19.43	.808 20.52	.200 5.08	.208 5.28	.965 24.51
MCDM3-10P**	1.330 33.78	.840 21.34	.958 24.33	.200 5.08	.208 5.28	1.115 28.32
MCDM3-10S**	1.330 33.78	.915 23.24	.958 24.33	.200 5.08	.208 5.28	1.115 28.32
MCDM3-12P**	1.480 37.59	.990 25.15	1.108 27.89	.200 5.08	.208 5.28	1.270 32.26
MCDM3-12S**	1.480 37.59	1.065 27.05	1.108 27.89	.200 5.08	.208 5.28	1.270 32.26
MCDM3-17P**	1.430 36.32	.940 23.88	1.058 26.87	.245 6.22	.250 6.35	1.215 30.86
MCDM3-17S**	1.430 36.32	1.015 25.78	1.058 26.87	.245 6.22	.250 6.35	1.215 30.86

5 Pin and Socket Connectors

MCDM Series Metal Shell RF COMBOMATE Connectors (Continued)

Contact Arrangement as Viewed from the Engaging Face of the Pin Side

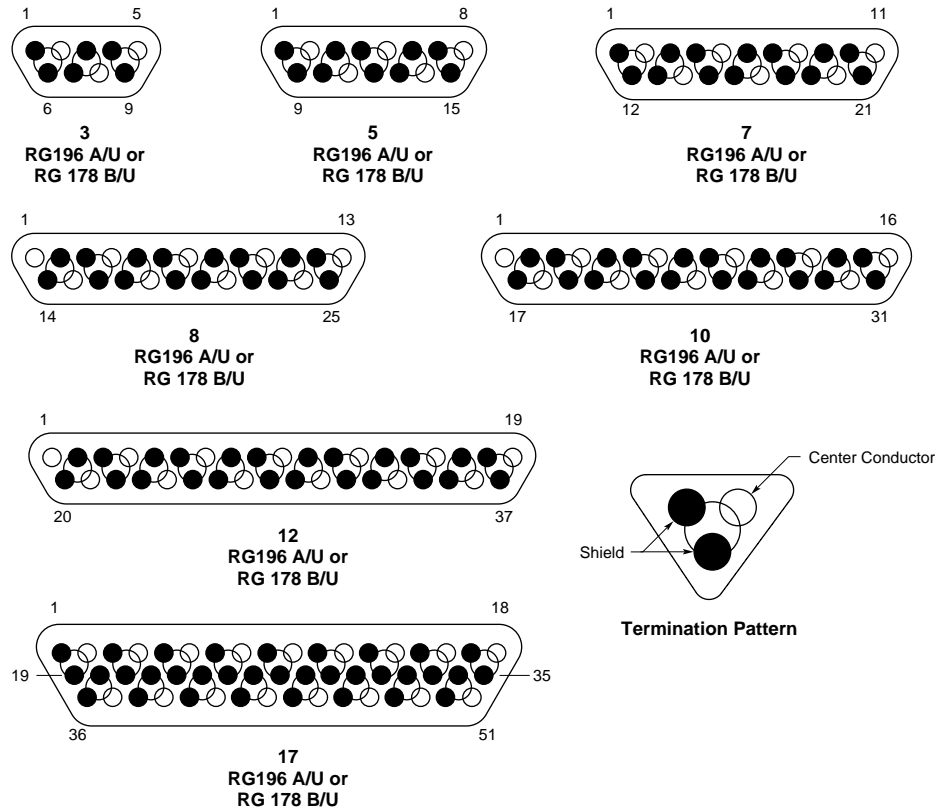

Note: The above contact arrangements are the maximum densities that can be obtained in each shell size when using RG 196 A/U or RG 178 B/U cable.

Panel Mounting
Dimensions — MCDM

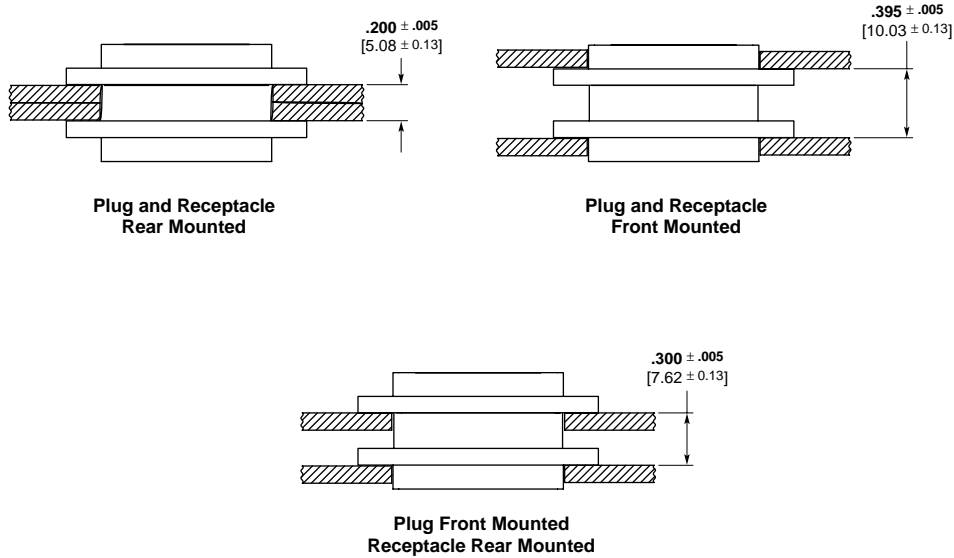

Panel Cutout Dimensions

Screw Mounting

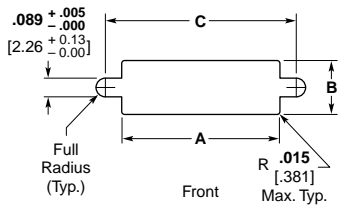

Figure 1

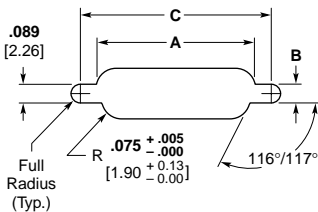

Figure 2

Note: Front mounting preferred.

Number of Contacts	Fig.	A		B		C	
		+ .004 [+ .102]	- .000 [- .000]	+ .004 [+ .102]	- .000 [- .000]	+ .005 [+ .127]	- .000 [- .000]
9	1	.412	[10.46]	.177	[4.50]	.570	[14.48]
	2	.384	[9.75]	.222	[5.64]	.570	[14.48]
15	1	.562	[14.27]	.177	[4.50]	.720	[18.29]
	2	.534	[13.56]	.222	[5.64]	.720	[18.29]
21	1	.712	[18.08]	.177	[4.50]	.870	[22.10]
	2	.684	[17.37]	.222	[5.64]	.870	[22.10]
25	1	.812	[20.62]	.177	[4.50]	.970	[24.64]
	2	.784	[19.91]	.222	[5.64]	.970	[24.64]
31	1	.962	[24.43]	.177	[4.50]	1.120	[28.45]
	2	.934	[23.72]	.222	[5.64]	1.120	[28.45]
37	1	1.112	[28.24]	.177	[4.50]	1.270	[32.26]
	2	1.084	[27.53]	.222	[5.64]	1.270	[32.26]
51	1	1.062	[26.97]	.224	[5.69]	1.220	[30.99]
	2	1.034	[26.26]	.264	[6.71]	1.220	[30.99]

MCK (Metal Shell)

Military Part No.	MICRODOT Part No.	Military Part No.	MICRODOT Part No.	Military Part No.	MICRODOT Part No.
M83513/01-A*	MCK--B- 9PS	M83513/03-E06*	MCK--B- 31P5L4-1.0	M83513/03-A14*	MCK--B- 9P6G9-72.0
M83513/01-B*	MCK--B- 15PS	M83513/03-F06*	MCK--B- 37P5L4-1.0	M83513/03-B14*	MCK--B- 15P6G9-72.0
M83513/01-C*	MCK--B- 21PS	M83513/03-G06*	MCK--B- 51P5L4-1.0	M83513/03-C14*	MCK--B- 21P6G9-72.0
M83513/01-D*	MCK--B- 25PS	M83513/03-H06*	MCK--B-100P5L4-1.0	M83513/03-D14*	MCK--B- 25P6G9-72.0
M83513/01-E*	MCK--B- 31PS	M83513/03-A07*	MCK--B- 9P5L5-0.5	M83513/03-E14*	MCK--B- 31P6G9-72.0
M83513/01-F*	MCK--B- 37PS	M83513/03-B07*	MCK--B- 15P5L5-0.5	M83513/03-F14*	MCK--B- 37P6G9-72.0
M83513/01-G*	MCK--B- 51PS	M83513/03-C07*	MCK--B- 21P5L5-0.5	M83513/03-G14*	MCK--B- 51P6G9-72.0
M83513/01-H*	MCK--B-100PS	M83513/03-D07*	MCK--B- 25P5L5-0.5	M83513/03-H14*	MCK--B-100P6G9-72.0
M83513/02-A*	MCK--B- 9SS	M83513/03-E07*	MCK--B- 31P5L5-0.5	M83513/03-A15*	MCK--B- 9P6Q1-72.0
M83513/02-B*	MCK--B- 15SS	M83513/03-F07*	MCK--B- 37P5L5-0.5	M83513/03-B15*	MCK--B- 15P6Q1-72.0
M83513/02-C*	MCK--B- 21SS	M83513/03-G07*	MCK--B- 51P5L5-0.5	M83513/03-C15*	MCK--B- 21P6Q1-72.0
M83513/02-D*	MCK--B- 25SS	M83513/03-H07*	MCK--B-100P5L5-0.5	M83513/03-D15*	MCK--B- 25P6Q1-72.0
M83513/02-E*	MCK--B- 31SS	M83513/03-A08*	MCK--B- 9P5L5-1.0	M83513/03-E15*	MCK--B- 31P6Q1-72.0
M83513/02-F*	MCK--B- 37SS	M83513/03-B08*	MCK--B- 15P5L5-1.0	M83513/03-F15*	MCK--B- 37P6Q1-72.0
M83513/02-G*	MCK--B- 51SS	M83513/03-C08*	MCK--B- 21P5L5-1.0	M83513/03-G15*	MCK--B- 51P6Q1-72.0
M83513/02-H*	MCK--B-100SS	M83513/03-D08*	MCK--B- 25P5L5-1.0	M83513/03-H15*	MCK--B-100P6Q1-72.0
M83513/03-A01*	MCK--B- 9P6G1-18.0	M83513/03-E08*	MCK--B- 31P5L5-1.0	M83513/03-A16*	MCK--B- 9P6Q9-72.0
M83513/03-B01*	MCK--B- 15P6G1-18.0	M83513/03-F08*	MCK--B- 37P5L5-1.0	M83513/03-B16*	MCK--B- 15P6Q9-72.0
M83513/03-C01*	MCK--B- 21P6G1-18.0	M83513/03-G08*	MCK--B- 51P5L5-1.0	M83513/03-C16*	MCK--B- 21P6Q9-72.0
M83513/03-D01*	MCK--B- 25P6G1-18.0	M83513/03-H08*	MCK--B-100P5L5-1.0	M83513/03-D16*	MCK--B- 25P6Q9-72.0
M83513/03-E01*	MCK--B- 31P6G1-18.0	M83513/03-A09*	MCK--B- 9P6Q1-18.0	M83513/03-E16*	MCK--B- 31P6Q9-72.0
M83513/03-F01*	MCK--B- 37P6G1-18.0	M83513/03-B09*	MCK--B- 15P6Q1-18.0	M83513/03-F16*	MCK--B- 37P6Q9-72.0
M83513/03-G01*	MCK--B- 51P6G1-18.0	M83513/03-C09*	MCK--B- 21P6Q1-18.0	M83513/03-G16*	MCK--B- 51P6Q9-72.0
M83513/03-H01*	MCK--B-100P6G1-18.0	M83513/03-D09*	MCK--B- 25P6Q1-18.0	M83513/03-H16*	MCK--B-100P6Q9-72.0
M83513/03-A02*	MCK--B- 9P6G1-36.0	M83513/03-E09*	MCK--B- 31P6Q1-18.0	M83513/04-A01*	MCK--B- 9S6G1-18.0
M83513/03-B02*	MCK--B- 15P6G1-36.0	M83513/03-F09*	MCK--B- 37P6Q1-18.0	M83513/04-B01*	MCK--B- 15S6G1-18.0
M83513/03-C02*	MCK--B- 21P6G1-36.0	M83513/03-G09*	MCK--B- 51P6Q1-18.0	M83513/04-C01*	MCK--B- 21S6G1-18.0
M83513/03-D02*	MCK--B- 25P6G1-36.0	M83513/03-H09*	MCK--B-100P6Q1-18.0	M83513/04-D01*	MCK--B- 25S6G1-18.0
M83513/03-E02*	MCK--B- 31P6G1-36.0	M83513/03-A10*	MCK--B- 9P6Q1-36.0	M83513/04-E01*	MCK--B- 31S6G1-18.0
M83513/03-F02*	MCK--B- 37P6G1-36.0	M83513/03-B10*	MCK--B- 15P6Q1-36.0	M83513/04-F01*	MCK--B- 37S6G1-18.0
M83513/03-G02*	MCK--B- 51P6G1-36.0	M83513/03-C10*	MCK--B- 21P6Q1-36.0	M83513/04-G01*	MCK--B- 51S6G1-18.0
M83513/03-H02*	MCK--B-100P6G1-36.0	M83513/03-D10*	MCK--B- 25P6Q1-36.0	M83513/04-H01*	MCK--B-100S6G1-18.0
M83513/03-A03*	MCK--B- 9P6G9-18.0	M83513/03-E10*	MCK--B- 31P6Q1-36.0	M83513/04-A02*	MCK--B- 9S6G1-36.0
M83513/03-B03*	MCK--B- 15P6G9-18.0	M83513/03-F10*	MCK--B- 37P6Q1-36.0	M83513/04-B02*	MCK--B- 15S6G1-36.0
M83513/03-C03*	MCK--B- 21P6G9-18.0	M83513/03-G10*	MCK--B- 51P6Q1-36.0	M83513/04-C02*	MCK--B- 21S6G1-36.0
M83513/03-D03*	MCK--B- 25P6G9-18.0	M83513/03-H10*	MCK--B-100P6Q1-36.0	M83513/04-D02*	MCK--B- 25S6G1-36.0
M83513/03-E03*	MCK--B- 31P6G9-18.0	M83513/03-A11*	MCK--B- 9P6Q9-18.0	M83513/04-E02*	MCK--B- 31S6G1-36.0
M83513/03-F03*	MCK--B- 37P6G9-18.0	M83513/03-B11*	MCK--B- 15P6Q9-18.0	M83513/04-F02*	MCK--B- 37S6G1-36.0
M83513/03-G03*	MCK--B- 51P6G9-18.0	M83513/03-C11*	MCK--B- 21P6Q9-18.0	M83513/04-G02*	MCK--B- 51S6G1-36.0
M83513/03-H03*	MCK--B-100P6G9-18.0	M83513/03-D11*	MCK--B- 25P6Q9-18.0	M83513/04-H02*	MCK--B-100S6G1-36.0
M83513/03-A04*	MCK--B- 9P6G9-36.0	M83513/03-E11*	MCK--B- 31P6Q9-18.0	M83513/04-A03*	MCK--B- 9S6G9-18.0
M83513/03-B04*	MCK--B- 15P6G9-36.0	M83513/03-F11*	MCK--B- 37P6Q9-18.0	M83513/04-B03*	MCK--B- 15S6G9-18.0
M83513/03-C04*	MCK--B- 21P6G9-36.0	M83513/03-G11*	MCK--B- 51P6Q9-18.0	M83513/04-C03*	MCK--B- 21S6G9-18.0
M83513/03-D04*	MCK--B- 25P6G9-36.0	M83513/03-H11*	MCK--B-100P6Q9-18.0	M83513/04-D03*	MCK--B- 25S6G9-18.0
M83513/03-E04*	MCK--B- 31P6G9-36.0	M83513/03-A12*	MCK--B- 9P6Q9-36.0	M83513/04-E03*	MCK--B- 31S6G9-18.0
M83513/03-F04*	MCK--B- 37P6G9-36.0	M83513/03-B12*	MCK--B- 15P6Q9-36.0	M83513/04-F03*	MCK--B- 37S6G9-18.0
M83513/03-G04*	MCK--B- 51P6G9-36.0	M83513/03-C12*	MCK--B- 21P6Q9-36.0	M83513/04-G03*	MCK--B- 51S6G9-18.0
M83513/03-H04*	MCK--B-100P6G9-36.0	M83513/03-D12*	MCK--B- 25P6Q9-36.0	M83513/04-H03*	MCK--B-100S6G9-18.0
M83513/03-A05*	MCK--B- 9P5L4-0.5	M83513/03-E12*	MCK--B- 31P6Q9-36.0	M83513/04-A04*	MCK--B- 9S6G9-36.0
M83513/03-B05*	MCK--B- 15P5L4-0.5	M83513/03-F12*	MCK--B- 37P6Q9-36.0	M83513/04-B04*	MCK--B- 15S6G9-36.0
M83513/03-C05*	MCK--B- 21P5L4-0.5	M83513/03-G12*	MCK--B- 51P6Q9-36.0	M83513/04-C04*	MCK--B- 21S6G9-36.0
M83513/03-D05*	MCK--B- 25P5L4-0.5	M83513/03-H12*	MCK--B-100P6Q9-36.0	M83513/04-D04*	MCK--B- 25S6G9-36.0
M83513/03-E05*	MCK--B- 31P5L4-0.5	M83513/03-A13*	MCK--B- 9P6G1-72.0	M83513/04-E04*	MCK--B- 31S6G9-36.0
M83513/03-F05*	MCK--B- 37P5L4-0.5	M83513/03-B13*	MCK--B- 15P6G1-72.0	M83513/04-F04*	MCK--B- 37S6G9-36.0
M83513/03-G05*	MCK--B- 51P5L4-0.5	M83513/03-C13*	MCK--B- 21P6G1-72.0	M83513/04-G04*	MCK--B- 51S6G9-36.0
M83513/03-H05*	MCK--B-100P5L4-0.5	M83513/03-D13*	MCK--B- 25P6G1-72.0	M83513/04-H04*	MCK--B-100S6G9-36.0
M83513/03-A06*	MCK--B- 9P5L4-1.0	M83513/03-E13*	MCK--B- 31P6G1-72.0	M83513/04-A05*	MCK--B- 9S5L4-0.5
M83513/03-B06*	MCK--B- 15P5L4-1.0	M83513/03-F13*	MCK--B- 37P6G1-72.0	M83513/04-B05*	MCK--B- 15S5L4-0.5
M83513/03-C06*	MCK--B- 21P5L4-1.0	M83513/03-G13*	MCK--B- 51P6G1-72.0	M83513/04-C05*	MCK--B- 21S5L4-0.5
M83513/03-D06*	MCK--B- 25P5L4-1.0	M83513/03-H13*	MCK--B-100P6G1-72.0	M83513/04-D05*	MCK--B- 25S5L4-0.5

MCK (Metal Shell) (Continued)

Military Part No.	MICRODOT Part No.	Military Part No.	MICRODOT Part No.	Military Part No.	MICRODOT Part No.
M83513/04-E05*	MCK-**-B- 31S5L4-0.5	M83513/04-D09*	MCK-**-B- 25S6Q1-18.0	M83513/04-C13*	MCK-**-B- 21S6G1-72.0
M83513/04-F05*	MCK-**-B- 37S5L4-0.5	M83513/04-E09*	MCK-**-B- 31S6Q1-18.0	M83513/04-D13*	MCK-**-B- 25S6G1-72.0
M83513/04-G05*	MCK-**-B- 51S5L4-0.5	M83513/04-F09*	MCK-**-B- 37S6Q1-18.0	M83513/04-E13*	MCK-**-B- 31S6G1-72.0
M83513/04-H05*	MCK-**-B-100S5L4-0.5	M83513/04-G09*	MCK-**-B- 51S6Q1-18.0	M83513/04-F13*	MCK-**-B- 37S6G1-72.0
M83513/04-A06*	MCK-**-B- 9S5L4-1.0	M83513/04-H09*	MCK-**-B-100S6Q1-18.0	M83513/04-G13*	MCK-**-B- 51S6G1-72.0
M83513/04-B06*	MCK-**-B- 15S5L4-1.0	M83513/04-A10*	MCK-**-B- 9S6Q1-36.0	M83513/04-H13*	MCK-**-B-100S6G1-72.0
M83513/04-C06*	MCK-**-B- 21S5L4-1.0	M83513/04-B10*	MCK-**-B- 15S6Q1-36.0	M83513/04-A14*	MCK-**-B- 9S6G9-72.0
M83513/04-D06*	MCK-**-B- 25S5L4-1.0	M83513/04-C10*	MCK-**-B- 21S6Q1-36.0	M83513/04-B14*	MCK-**-B- 15S6G9-72.0
M83513/04-E06*	MCK-**-B- 31S5L4-1.0	M83513/04-D10*	MCK-**-B- 25S6Q1-36.0	M83513/04-C14*	MCK-**-B- 21S6G9-72.0
M83513/04-F06*	MCK-**-B- 37S5L4-1.0	M83513/04-E10*	MCK-**-B- 31S6Q1-36.0	M83513/04-D14*	MCK-**-B- 25S6G9-72.0
M83513/04-G06*	MCK-**-B- 51S5L4-1.0	M83513/04-F10*	MCK-**-B- 37S6Q1-36.0	M83513/04-E14*	MCK-**-B- 31S6G9-72.0
M83513/04-H06*	MCK-**-B-100S5L4-1.0	M83513/04-G10*	MCK-**-B- 51S6Q1-36.0	M83513/04-F14*	MCK-**-B- 37S6G9-72.0
M83513/04-A07*	MCK-**-B- 9S5L5-0.5	M83513/04-H10*	MCK-**-B-100S6Q1-36.0	M83513/04-G14*	MCK-**-B- 51S6G9-72.0
M83513/04-B07*	MCK-**-B- 15S5L5-0.5	M83513/04-A11*	MCK-**-B- 9S6Q9-18.0	M83513/04-H14*	MCK-**-B-100S6G9-72.0
M83513/04-C07*	MCK-**-B- 21S5L5-0.5	M83513/04-B11*	MCK-**-B- 15S6Q9-18.0	M83513/04-A15*	MCK-**-B- 9S6Q1-72.0
M83513/04-D07*	MCK-**-B- 25S5L5-0.5	M83513/04-C11*	MCK-**-B- 21S6Q9-18.0	M83513/04-B15*	MCK-**-B- 15S6Q1-72.0
M83513/04-E07*	MCK-**-B- 31S5L5-0.5	M83513/04-D11*	MCK-**-B- 25S6Q9-18.0	M83513/04-C15*	MCK-**-B- 21S6Q1-72.0
M83513/04-F07*	MCK-**-B- 37S5L5-0.5	M83513/04-E11*	MCK-**-B- 31S6Q9-18.0	M83513/04-D15*	MCK-**-B- 25S6Q1-72.0
M83513/04-G07*	MCK-**-B- 51S5L5-0.5	M83513/04-F11*	MCK-**-B- 37S6Q9-18.0	M83513/04-E15*	MCK-**-B- 31S6Q1-72.0
M83513/04-H07*	MCK-**-B-100S5L5-0.5	M83513/04-G11*	MCK-**-B- 51S6Q9-18.0	M83513/04-F15*	MCK-**-B- 37S6Q1-72.0
M83513/04-A08*	MCK-**-B- 9S5L5-1.0	M83513/04-H11*	MCK-**-B-100S6Q9-18.0	M83513/04-G15*	MCK-**-B- 51S6Q1-72.0
M83513/04-B08*	MCK-**-B- 15S5L5-1.0	M83513/04-A12*	MCK-**-B- 9S6Q9-36.0	M83513/04-H15*	MCK-**-B-100S6Q1-72.0
M83513/04-C08*	MCK-**-B- 21S5L5-1.0	M83513/04-B12*	MCK-**-B- 15S6Q9-36.0	M83513/04-A16*	MCK-**-B- 9S6Q9-72.0
M83513/04-D08*	MCK-**-B- 25S5L5-1.0	M83513/04-C12*	MCK-**-B- 21S6Q9-36.0	M83513/04-B16*	MCK-**-B- 15S6Q9-72.0
M83513/04-E08*	MCK-**-B- 31S5L5-1.0	M83513/04-D12*	MCK-**-B- 25S6Q9-36.0	M83513/04-C16*	MCK-**-B- 21S6Q9-72.0
M83513/04-F08*	MCK-**-B- 37S5L5-1.0	M83513/04-E12*	MCK-**-B- 31S6Q9-36.0	M83513/04-D16*	MCK-**-B- 25S6Q9-72.0
M83513/04-G08*	MCK-**-B- 51S5L5-1.0	M83513/04-F12*	MCK-**-B- 37S6Q9-36.0	M83513/04-E16*	MCK-**-B- 31S6Q9-72.0
M83513/04-H08*	MCK-**-B-100S5L5-1.0	M83513/04-G12*	MCK-**-B- 51S6Q9-36.0	M83513/04-F16*	MCK-**-B- 37S6Q9-72.0
M83513/04-A09*	MCK-**-B- 9S6Q1-18.0	M83513/04-H12*	MCK-**-B-100S6Q9-36.0	M83513/04-G16*	MCK-**-B- 51S6Q9-72.0
M83513/04-B09*	MCK-**-B- 15S6Q1-18.0	M83513/04-A13*	MCK-**-B- 9S6G1-72.0	M83513/04-H16*	MCK-**-B-100S6Q9-72.0
M83513/04-C09*	MCK-**-B- 21S6Q1-18.0	M83513/04-B13*	MCK-**-B- 15S6G1-72.0		

*C = Cadmium or N = Nickel (space applications only)
 **C2 = Cadmium or N1 = Nickel (space applications only)

Hardware

Military Part No.	MICRODOT Part No.	Military Part No.	MICRODOT Part No.	Military Part No.	MICRODOT Part No.
M83513/05-02	"A. HD, J/S, L.F. #2"	M83513/05-05	"S. HD, J/S, L.F. #2"	M83513/05-07	"JACKPOST ASSY #2"
M83513/05-12	"A. HD, J/S, L.F. #4"	M83513/05-15	"S. HD, J/S, L.F. #4"	M83513/05-17	"JACKPOST ASSY, #4"
M83513/05-03	"A. HD, J/S,H.F. #2"	M83513/05-06	"S. HD, J/S, H.F. #2"		
M83513/05-13	"A. HD, J/S, H.F. #4"	M83513/05-16	"S. HD, J/S, H.F. #4"		

MCDR (Plastic Shell)

Military Part No.	MICRODOT Part No.	Military Part No.	MICRODOT Part No.	Military Part No.	MICRODOT Part No.
M83513/06-A	MCDR3-B- 9PS	M83513/07-G	MCDR3-B-51SS	M83513/08-F02	MCDR3-B-37P6G1-36.0
M83513/06-B	MCDR3-B-15PS	M83513/08-A01	MCDR3-B- 9P6G1-18.0	M83513/08-G02	MCDR3-B-51P6G1-36.0
M83513/06-C	MCDR3-B-21PS	M83513/08-B01	MCDR3-B-15P6G1-18.0	M83513/08-A03	MCDR3-B- 9P6G9-18.0
M83513/06-D	MCDR3-B-25PS	M83513/08-C01	MCDR3-B-21P6G1-18.0	M83513/08-B03	MCDR3-B-15P6G9-18.0
M83513/06-E	MCDR3-B-31PS	M83513/08-D01	MCDR3-B-25P6G1-18.0	M83513/08-C03	MCDR3-B-21P6G9-18.0
M83513/06-F	MCDR3-B-37PS	M83513/08-E01	MCDR3-B-31P6G1-18.0	M83513/08-D03	MCDR3-B-25P6G9-18.0
M83513/06-G	MCDR3-B-51PS	M83513/08-F01	MCDR3-B-37P6G1-18.0	M83513/08-E03	MCDR3-B-31P6G9-18.0
M83513/07-A	MCDR3-B- 9SS	M83513/08-G01	MCDR3-B-51P6G1-18.0	M83513/08-F03	MCDR3-B-37P6G9-18.0
M83513/07-B	MCDR3-B-15SS	M83513/08-A02	MCDR3-B- 9P6G1-36.0	M83513/08-G03	MCDR3-B-51P6G9-18.0
M83513/07-C	MCDR3-B-21SS	M83513/08-B02	MCDR3-B-15P6G1-36.0	M83513/08-A04	MCDR3-B- 9P6G9-36.0
M83513/07-D	MCDR3-B-25SS	M83513/08-C02	MCDR3-B-21P6G1-36.0	M83513/08-B04	MCDR3-B-15P6G9-36.0
M83513/07-E	MCDR3-B-31SS	M83513/08-D02	MCDR3-B-25P6G1-36.0	M83513/08-C04	MCDR3-B-21P6G9-36.0
M83513/07-F	MCDR3-B-37SS	M83513/08-E02	MCDR3-B-31P6G1-36.0	M83513/08-D04	MCDR3-B-25P6G9-36.0

MCDR (Plastic Shell) (Continued)

Military Part No.	MICRODOT Part No.
M83513/08-E04	MCDR3-B-31P6G9-36.0
M83513/08-F04	MCDR3-B-37P6G9-36.0
M83513/08-G04	MCDR3-B-51P6G9-36.0
M83513/08-A05	MCDR3-B- 9P5L4-0.5
M83513/08-B05	MCDR3-B-15P5L4-0.5
M83513/08-C05	MCDR3-B-21P5L4-0.5
M83513/08-D05	MCDR3-B-25P5L4-0.5
M83513/08-E05	MCDR3-B-31P5L4-0.5
M83513/08-F05	MCDR3-B-37P5L4-0.5
M83513/08-G05	MCDR3-B-51P5L4-0.5
M83513/08-A06	MCDR3-B- 9P5L4-1.0
M83513/08-B06	MCDR3-B-15P5L4-1.0
M83513/08-C06	MCDR3-B-21P5L4-1.0
M83513/08-D06	MCDR3-B-25P5L4-1.0
M83513/08-E06	MCDR3-B-31P5L4-1.0
M83513/08-F06	MCDR3-B-37P5L4-1.0
M83513/08-G06	MCDR3-B-51P5L4-1.0
M83513/08-A07	MCDR3-B- 9P5L5-0.5
M83513/08-B07	MCDR3-B-15P5L5-0.5
M83513/08-C07	MCDR3-B-21P5L5-0.5
M83513/08-D07	MCDR3-B-25P5L5-0.5
M83513/08-E07	MCDR3-B-31P5L5-0.5
M83513/08-F07	MCDR3-B-37P5L5-0.5
M83513/08-G07	MCDR3-B-51P5L5-0.5
M83513/08-A08	MCDR3-B- 9P5L5-1.0
M83513/08-B08	MCDR3-B-15P5L5-1.0
M83513/08-C08	MCDR3-B-21P5L5-1.0
M83513/08-D08	MCDR3-B-25P5L5-1.0
M83513/08-E08	MCDR3-B-31P5L5-1.0
M83513/08-F08	MCDR3-B-37P5L5-1.0
M83513/08-G08	MCDR3-B-51P5L5-1.0
M83513/08-A09	MCDR3-B- 9P6Q1-18.0
M83513/08-B09	MCDR3-B-15P6Q1-18.0
M83513/08-C09	MCDR3-B-21P6Q1-18.0
M83513/08-D09	MCDR3-B-25P6Q1-18.0
M83513/08-E09	MCDR3-B-31P6Q1-18.0
M83513/08-F09	MCDR3-B-37P6Q1-18.0
M83513/08-G09	MCDR3-B-51P6Q1-18.0
M83513/08-A10	MCDR3-B- 9P6Q1-36.0
M83513/08-B10	MCDR3-B-15P6Q1-36.0
M83513/08-C10	MCDR3-B-21P6Q1-36.0
M83513/08-D10	MCDR3-B-25P6Q1-36.0
M83513/08-E10	MCDR3-B-31P6Q1-36.0
M83513/08-F10	MCDR3-B-37P6Q1-36.0
M83513/08-G10	MCDR3-B-51P6Q1-36.0
M83513/08-A11	MCDR3-B- 9P6Q9-18.0
M83513/08-B11	MCDR3-B-15P6Q9-18.0
M83513/08-C11	MCDR3-B-21P6Q9-18.0
M83513/08-D11	MCDR3-B-25P6Q9-18.0
M83513/08-E11	MCDR3-B-31P6Q9-18.0
M83513/08-F11	MCDR3-B-37P6Q9-18.0
M83513/08-G11	MCDR3-B-51P6Q9-18.0
M83513/08-A12	MCDR3-B- 9P6Q9-36.0
M83513/08-B12	MCDR3-B-15P6Q9-36.0
M83513/08-C12	MCDR3-B-21P6Q9-36.0
M83513/08-D12	MCDR3-B-25P6Q9-36.0
M83513/08-E12	MCDR3-B-31P6Q9-36.0
M83513/08-F12	MCDR3-B-37P6Q9-36.0
M83513/08-G12	MCDR3-B-51P6Q9-36.0
M83513/08-A13	MCDR3-B- 9P6G1-72.0

Military Part No.	MICRODOT Part No.
M83513/08-B13	MCDR3-B-15P6G1-72.0
M83513/08-C13	MCDR3-B-21P6G1-72.0
M83513/08-D13	MCDR3-B-25P6G1-72.0
M83513/08-E13	MCDR3-B-31P6G1-72.0
M83513/08-F13	MCDR3-B-37P6G1-72.0
M83513/08-G13	MCDR3-B-51P6G1-72.0
M83513/08-A14	MCDR3-B- 9P6G9-72.0
M83513/08-B14	MCDR3-B-15P6G9-72.0
M83513/08-C14	MCDR3-B-21P6G9-72.0
M83513/08-D14	MCDR3-B-25P6G9-72.0
M83513/08-E14	MCDR3-B-31P6G9-72.0
M83513/08-F14	MCDR3-B-37P6G9-72.0
M83513/08-G14	MCDR3-B-51P6G9-72.0
M83513/08-A15	MCDR3-B- 9P6Q1-72.0
M83513/08-B15	MCDR3-B-15P6Q1-72.0
M83513/08-C15	MCDR3-B-21P6Q1-72.0
M83513/08-D15	MCDR3-B-25P6Q1-72.0
M83513/08-E15	MCDR3-B-31P6Q1-72.0
M83513/08-F15	MCDR3-B-37P6Q1-72.0
M83513/08-G15	MCDR3-B-51P6Q1-72.0
M83513/08-A16	MCDR3-B- 9P6Q9-72.0
M83513/08-B16	MCDR3-B-15P6Q9-72.0
M83513/08-C16	MCDR3-B-21P6Q9-72.0
M83513/08-D16	MCDR3-B-25P6Q9-72.0
M83513/08-E16	MCDR3-B-31P6Q9-72.0
M83513/08-F16	MCDR3-B-37P6Q9-72.0
M83513/08-G16	MCDR3-B-51P6Q9-72.0
M83513/09-A01	MCDR3-B- 9S6G1-18.0
M83513/09-B01	MCDR3-B-15S6G1-18.0
M83513/09-C01	MCDR3-B-21S6G1-18.0
M83513/09-D01	MCDR3-B-25S6G1-18.0
M83513/09-E01	MCDR3-B-31S6G1-18.0
M83513/09-F01	MCDR3-B-37S6G1-18.0
M83513/09-G01	MCDR3-B-51S6G1-18.0
M83513/09-A02	MCDR3-B- 9S6G1-36.0
M83513/09-B02	MCDR3-B-15S6G1-36.0
M83513/09-C02	MCDR3-B-21S6G1-36.0
M83513/09-D02	MCDR3-B-25S6G1-36.0
M83513/09-E02	MCDR3-B-31S6G1-36.0
M83513/09-F02	MCDR3-B-37S6G1-36.0
M83513/09-G02	MCDR3-B-51S6G1-36.0
M83513/09-A03	MCDR3-B- 9S6G9-18.0
M83513/09-B03	MCDR3-B-15S6G9-18.0
M83513/09-C03	MCDR3-B- 21S6G9-18.0
M83513/09-D03	MCDR3-B-25S6G9-18.0
M83513/09-E03	MCDR3-B-31S6G9-18.0
M83513/09-F03	MCDR3-B-37S6G9-18.0
M83513/09-G03	MCDR3-B-51S6G9-18.0
M83513/09-A04	MCDR3-B- 9S6G9-36.0
M83513/09-B04	MCDR3-B-15S6G9-36.0
M83513/09-C04	MCDR3-B-21S6G9-36.0
M83513/09-D04	MCDR3-B-25S6G9-36.0
M83513/09-E04	MCDR3-B-31S6G9-36.0
M83513/09-F04	MCDR3-B-37S6G9-36.0
M83513/09-G04	MCDR3-B-51S6G9-36.0
M83513/09-A05	MCDR3-B- 9S5L4-0.5
M83513/09-B05	MCDR3-B-15S5L4-0.5
M83513/09-C05	MCDR3-B-21S5L4-0.5
M83513/09-D05	MCDR3-B-25S5L4-0.5
M83513/09-E05	MCDR3-B-31S5L4-0.5

Military Part No.	MICRODOT Part No.
M83513/09-F05	MCDR3-B-37S5L4-0.5
M83513/09-G05	MCDR3-B-51S5L4-0.5
M83513/09-A06	MCDR3-B- 9S5L4-1.0
M83513/09-B06	MCDR3-B-15S5L4-1.0
M83513/09-C06	MCDR3-B-21S5L4-1.0
M83513/09-D06	MCDR3-B-25S5L4-1.0
M83513/09-E06	MCDR3-B-31S5L4-1.0
M83513/09-F06	MCDR3-B-37S5L4-1.0
M83513/09-G06	MCDR3-B-51S5L4-1.0
M83513/09-A07	MCDR3-B- 9S5L5-0.5
M83513/09-B07	MCDR3-B-15S5L5-0.5
M83513/09-C07	MCDR3-B-21S5L5-0.5
M83513/09-D07	MCDR3-B-25S5L5-0.5
M83513/09-E07	MCDR3-B-31S5L5-0.5
M83513/09-F07	MCDR3-B-37S5L5-0.5
M83513/09-G07	MCDR3-B-51S5L5-0.5
M83513/09-A08	MCDR3-B- 9S5L5-1.0
M83513/09-B08	MCDR3-B-15S5L5-1.0
M83513/09-C08	MCDR3-B-21S5L5-1.0
M83513/09-D08	MCDR3-B-25S5L5-1.0
M83513/09-E08	MCDR3-B-31S5L5-1.0
M83513/09-F08	MCDR3-B-37S5L5-1.0
M83513/09-G08	MCDR3-B-51S5L5-1.0
M83513/09-A09	MCDR3-B- 9S6Q1-18.0
M83513/09-B09	MCDR3-B-15S6Q1-18.0
M83513/09-C09	MCDR3-B-21S6Q1-18.0
M83513/09-D09	MCDR3-B-25S6Q1-18.0
M83513/09-E09	MCDR3-B-31S6Q1-18.0
M83513/09-F09	MCDR3-B-37S6Q1-18.0
M83513/09-G09	MCDR3-B-51S6Q1-18.0
M83513/09-A10	MCDR3-B- 9S6Q1-36.0
M83513/09-B10	MCDR3-B-15S6Q1-36.0
M83513/09-C10	MCDR3-B-21S6Q1-36.0
M83513/09-D10	MCDR3-B-25S6Q1-36.0
M83513/09-E10	MCDR3-B-31S6Q1-36.0
M83513/09-F10	MCDR3-B-37S6Q1-36.0
M83513/09-G10	MCDR3-B-51S6Q1-36.0
M83513/09-A11	MCDR3-B- 9S6Q9-18.0
M83513/09-B11	MCDR3-B-15S6Q9-18.0
M83513/09-C11	MCDR3-B-21S6Q9-18.0
M83513/09-D11	MCDR3-B-25S6Q9-18.0
M83513/09-E11	MCDR3-B-31S6Q9-18.0
M83513/09-F11	MCDR3-B-37S6Q9-18.0
M83513/09-G11	MCDR3-B-51S6Q9-18.0
M83513/09-A12	MCDR3-B- 9S6Q9-36.0
M83513/09-B12	MCDR3-B-15S6Q9-36.0
M83513/09-C12	MCDR3-B-21S6Q9-36.0
M83513/09-D12	MCDR3-B-25S6Q9-36.0
M83513/09-E12	MCDR3-B-31S6Q9-36.0
M83513/09-F12	MCDR3-B-37S6Q9-36.0
M83513/09-G12	MCDR3-B-51S6Q9-36.0
M83513/09-A13	MCDR3-B- 9S6G1-72.0
M83513/09-B13	MCDR3-B-15S6G1-72.0
M83513/09-C13	MCDR3-B-21S6G1-72.0
M83513/09-D13	MCDR3-B-25S6G1-72.0
M83513/09-E13	MCDR3-B-31S6G1-72.0
M83513/09-F13	MCDR3-B-37S6G1-72.0
M83513/09-G13	MCDR3-B-51S6G1-72.0
M83513/09-A14	MCDR3-B- 9S6G9-72.0
M83513/09-B14	MCDR3-B-15S6G9-72.0

MCDR (Plastic Shell) (Continued)

Military Part No.	MICRODOT Part No.
M83513/09-C14	MCDR3-B-21S6G9-72.0
M83513/09-D14	MCDR3-B-25S6G9-72.0
M83513/09-E14	MCDR3-B-31S6G9-72.0
M83513/09-F14	MCDR3-B-37S6G9-72.0
M83513/09-G14	MCDR3-B-51S6G9-72.0
M83513/09-A15	MCDR3-B- 9S6Q1-72.0
M83513/09-B15	MCDR3-B-15S6Q1-72.0

Military Part No.	MICRODOT Part No.
M83513/09-C15	MCDR3-B-21S6Q1-72.0
M83513/09-D15	MCDR3-B-25S6Q1-72.0
M83513/09-E15	MCDR3-B-31S6Q1-72.0
M83513/09-F15	MCDR3-B-37S6Q1-72.0
M83513/09-G15	MCDR3-B-51S6Q1-72.0
M83513/09-A16	MCDR3-B- 9S6Q9-72.0
M83513/09-B16	MCDR3-B-15S6Q9-72.0

Military Part No.	MICRODOT Part No.
M83513/09-C16	MCDR3-B-21S6Q9-72.0
M83513/09-D16	MCDR3-B-25S6Q9-72.0
M83513/09-E16	MCDR3-B-31S6Q9-72.0
M83513/09-F16	MCDR3-B-37S6Q9-72.0
M83513/09-G16	MCDR3-B-51S6Q9-72.0

MCK (Metal Shell)

Military Part No.	MICRODOT Part No.
M83513/10-A01*N	MCK--B- 9PRT1
M83513/10-B01*N	MCK--B- 15PRT1
M83513/10-C01*N	MCK--B- 21PRT1
M83513/10-D01*N	MCK--B- 25PRT1
M83513/10-E01*N	MCK--B- 31PRT1
M83513/10-F01*N	MCK--B- 37PRT1
M83513/10-A01*P	MCK--P- 9PRT1
M83513/10-B01*P	MCK--P- 15PRT1
M83513/10-C01*P	MCK--P- 21PRT1
M83513/10-D01*P	MCK--P- 25PRT1
M83513/10-E01*P	MCK--P- 31PRT1
M83513/10-F01*P	MCK--P- 37PRT1
M83513/10-A02*N	MCK--B- 9PRT1A
M83513/10-B02*N	MCK--B- 15PRT1A
M83513/10-C02*N	MCK--B- 21PRT1A
M83513/10-D02*N	MCK--B- 25PRT1A
M83513/10-E02*N	MCK--B- 31PRT1A
M83513/10-F02*N	MCK--B- 37PRT1A
M83513/10-A02*P	MCK--P- 9PRT1A
M83513/10-B02*P	MCK--P- 15PRT1A
M83513/10-C02*P	MCK--P- 21PRT1A
M83513/10-D02*P	MCK--P- 25PRT1A
M83513/10-E02*P	MCK--P- 31PRT1A
M83513/10-F02*P	MCK--P- 37PRT1A
M83513/10-A03*N	MCK--B- 9PRT1B
M83513/10-B03*N	MCK--B- 15PRT1B
M83513/10-C03*N	MCK--B- 21PRT1B
M83513/10-D03*N	MCK--B- 25PRT1B
M83513/10-E03*N	MCK--B- 31PRT1B
M83513/10-F03*N	MCK--B- 37PRT1B
M83513/10-A03*P	MCK--P- 9PRT1B
M83513/10-B03*P	MCK--P- 15PRT1B
M83513/10-C03*P	MCK--P- 21PRT1B
M83513/10-D03*P	MCK--P- 25PRT1B
M83513/10-E03*P	MCK--P- 31PRT1B
M83513/10-F03*P	MCK--P- 37PRT1B
M83513/11-G01*N	MCK--B- 51PRT1
M83513/11-G01*P	MCK--P- 51PRT1
M83513/11-G02*N	MCK--B- 51PRT1A
M83513/11-G02*P	MCK--P- 51PRT1A
M83513/11-G03*N	MCK--B- 51PRT1B
M83513/11-G03*P	MCK--P- 51PRT1B
M83513/12-H01*N	MCK--B-100PRT1
M83513/12-H01*P	MCK--P-100PRT1
M83513/12-H02*N	MCK--B-100PRT1A
M83513/12-H02*P	MCK--P-100PRT1A
M83513/12-H03*N	MCK--B-100PRT1B

Military Part No.	MICRODOT Part No.
M83513/12-H03*P	MCK--P-100PRT1B
M83513/13-A01*N	MCK--B- 9SRT1
M83513/13-B01*N	MCK--B- 15SRT1
M83513/13-C01*N	MCK--B- 21SRT1
M83513/13-D01*N	MCK--B- 25SRT1
M83513/13-E01*N	MCK--B- 31SRT1
M83513/13-F01*N	MCK--B- 37SRT1
M83513/13-A01*P	MCK--P- 9SRT1
M83513/13-B01*P	MCK--P- 15SRT1
M83513/13-C01*P	MCK--P- 21SRT1
M83513/13-D01*P	MCK--P- 25SRT1
M83513/13-E01*P	MCK--P- 31SRT1
M83513/13-F01*P	MCK--P- 37SRT1
M83513/13-A02*N	MCK--B- 9SRT1A
M83513/13-B02*N	MCK--B- 15SRT1A
M83513/13-C02*N	MCK--B- 21SRT1A
M83513/13-D02*N	MCK--B- 25SRT1A
M83513/13-E02*N	MCK--B- 31SRT1A
M83513/13-F02*N	MCK--B- 37SRT1A
M83513/13-A02*P	MCK--P- 9SRT1A
M83513/13-B02*P	MCK--P- 15SRT1A
M83513/13-C02*P	MCK--P- 21SRT1A
M83513/13-D02*P	MCK--P- 25SRT1A
M83513/13-E02*P	MCK--P- 31SRT1A
M83513/13-F02*P	MCK--P- 37SRT1A
M83513/13-A03*N	MCK--B- 9SRT1B
M83513/13-B03*N	MCK--B- 15SRT1B
M83513/13-C03*N	MCK--B- 21SRT1B
M83513/13-D03*N	MCK--B- 25SRT1B
M83513/13-E03*N	MCK--B- 31SRT1B
M83513/13-F03*N	MCK--B- 37SRT1B
M83513/13-A03*P	MCK--P- 9SRT1B
M83513/13-B03*P	MCK--P- 15SRT1B
M83513/13-C03*P	MCK--P- 21SRT1B
M83513/13-D03*P	MCK--P- 25SRT1B
M83513/13-E03*P	MCK--P- 31SRT1B
M83513/13-F03*P	MCK--P- 37SRT1B
M83513/14-G01*N	MCK--B- 51SRT1
M83513/14-G01*P	MCK--P- 51SRT1
M83513/14-G02*N	MCK--B- 51SRT1A
M83513/14-G02*P	MCK--P- 51SRT1A
M83513/14-G03*N	MCK--B- 51SRT1B
M83513/14-G03*P	MCK--P- 51SRT1B
M83513/15-H01*N	MCK--B-100SRT1
M83513/15-H01*P	MCK--P-100SRT1
M83513/15-H02*N	MCK--B-100SRT1A
M83513/15-H02*P	MCK--P-100SRT1A

Military Part No.	MICRODOT Part No.
M83513/15-H03*N	MCK--B-100SRT1B
M83513/15-H03*P	MCK--P-100SRT1B
M83513/16-A01*N	MCK--B- 9PRT3
M83513/16-B01*N	MCK--B- 15PRT3
M83513/16-C01*N	MCK--B- 21PRT3
M83513/16-D01*N	MCK--B- 25PRT3
M83513/16-E01*N	MCK--B- 31PRT3
M83513/16-F01*N	MCK--B- 37PRT3
M83513/16-A01*P	MCK--P- 9PRT3
M83513/16-B01*P	MCK--P- 15PRT3
M83513/16-C01*P	MCK--P- 21PRT3
M83513/16-D01*P	MCK--P- 25PRT3
M83513/16-E01*P	MCK--P- 31PRT3
M83513/16-F01*P	MCK--P- 37PRT3
M83513/16-A02*N	MCK--B- 9PRT3A
M83513/16-B02*N	MCK--B- 15PRT3A
M83513/16-C02*N	MCK--B- 21PRT3A
M83513/16-D02*N	MCK--B- 25PRT3A
M83513/16-E02*N	MCK--B- 31PRT3A
M83513/16-F02*N	MCK--B- 37PRT3A
M83513/16-A02*P	MCK--P- 9PRT3A
M83513/16-B02*P	MCK--P- 15PRT3A
M83513/16-C02*P	MCK--P- 21PRT3A
M83513/16-D02*P	MCK--P- 25PRT3A
M83513/16-E02*P	MCK--P- 31PRT3A
M83513/16-F02*P	MCK--P- 37PRT3A
M83513/16-A03*N	MCK--B- 9PRT3B
M83513/16-B03*N	MCK--B- 15PRT3B
M83513/16-C03*N	MCK--B- 21PRT3B
M83513/16-D03*N	MCK--B- 25PRT3B
M83513/16-E03*N	MCK--B- 31PRT3B
M83513/16-F03*N	MCK--B- 37PRT3B
M83513/16-A03*P	MCK--P- 9PRT3B
M83513/16-B03*P	MCK--P- 15PRT3B
M83513/16-C03*P	MCK--P- 21PRT3B
M83513/16-D03*P	MCK--P- 25PRT3B
M83513/16-E03*P	MCK--P- 31PRT3B
M83513/16-F03*P	MCK--P- 37PRT3B
M83513/17-G01*N	MCK--B- 51PRT3
M83513/17-G01*P	MCK--P- 51PRT3
M83513/17-G02*N	MCK--B- 51PRT3A
M83513/17-G02*P	MCK--P- 51PRT3A
M83513/17-G03*N	MCK--B- 51PRT3B
M83513/17-G03*P	MCK--P- 51PRT3B
M83513/18-H01*N	MCK--B-100PRT3
M83513/18-H01*P	MCK--P-100PRT3
M83513/18-H02*N	MCK--B-100PRT3A

MCK (Metal Shell) (Continued)

Military Part No.	MICRODOT Part No.	Military Part No.	MICRODOT Part No.	Military Part No.	MICRODOT Part No.
M83515/18-H02*P	MCK-**-P-100PRT3A	M83513/21-H03*N	MCK-**-B-100SRT3B	M83513/24-H03*P	MCK-**-P-100PST1B
M83513/18-H03*N	MCK-**-B-100PRT3B	M83513/21-H03*P	MCK-**-P-100SRT3B	M83513/25-A01*N	MCK-**-B- 9SST1
M83513/18-H03*P	MCK-**-P-100PRT3B	M83513/22-A01*N	MCK-**-B- 9PST1	M83513/25-B01*N	MCK-**-B- 15SST1
M83513/19-A01*N	MCK-**-B- 9SRT3	M83513/22-B01*N	MCK-**-B- 15PST1	M83513/25-C01*N	MCK-**-B- 21SST1
M83513/19-B01*N	MCK-**-B- 15SRT3	M83513/22-C01*N	MCK-**-B- 21PST1	M83513/25-D01*N	MCK-**-B- 25SST1
M83513/19-C01*N	MCK-**-B- 21SRT3	M83513/22-D01*N	MCK-**-B- 25PST1	M83513/25-E01*N	MCK-**-B- 31SST1
M83513/19-D01*N	MCK-**-B- 25SRT3	M83513/22-E01*N	MCK-**-B- 31PST1	M83513/25-F01*N	MCK-**-B- 37SST1
M83513/19-E01*N	MCK-**-B- 31SRT3	M83513/22-F01*N	MCK-**-B- 37PST1	M83513/25-A01*P	MCK-**-P- 9SST1
M83513/19-F01*N	MCK-**-B- 37SRT3	M83513/22-A01*P	MCK-**-P- 9PST1	M83513/25-B01*P	MCK-**-P- 15SST1
M83513/19-A01*P	MCK-**-P- 9SRT3	M83513/22-B01*P	MCK-**-P- 15PST1	M83513/25-C01*P	MCK-**-P- 21SST1
M83513/19-B01*P	MCK-**-P- 15SRT3	M83513/22-C01*P	MCK-**-P- 21PST1	M83513/25-D01*P	MCK-**-P- 25SST1
M83513/19-C01*P	MCK-**-P- 21SRT3	M83513/22-D01*P	MCK-**-P- 25PST1	M83513/25-E01*P	MCK-**-P- 31SST1
M83513/19-D01*P	MCK-**-P- 25SRT3	M83513/22-E01*P	MCK-**-P- 31PST1	M83513/25-F01*P	MCK-**-P- 37SST1
M83513/19-E01*P	MCK-**-P- 31SRT3	M83513/22-F01*P	MCK-**-P- 37PST1	M83513/25-A02*N	MCK-**-B- 9SST1A
M83513/19-F01*P	MCK-**-P- 37SRT3	M83513/22-A02*N	MCK-**-B- 9PST1A	M83513/25-B02*N	MCK-**-B- 15SST1A
M83513/19-A02*N	MCK-**-B- 9SRT3A	M83513/22-B02*N	MCK-**-B- 15PST1A	M83513/25-C02*N	MCK-**-B- 21SST1A
M83513/19-B02*N	MCK-**-B- 15SRT3A	M83513/22-C02*N	MCK-**-B- 21PST1A	M83513/25-D02*N	MCK-**-B- 25SST1A
M83513/19-C02*N	MCK-**-B- 21SRT3A	M83513/22-D02*N	MCK-**-B- 25PST1A	M83513/25-E02*N	MCK-**-B- 31SST1A
M83513/19-D02*N	MCK-**-B- 25SRT3A	M83513/22-E02*N	MCK-**-B- 31PST1A	M83513/25-F02*N	MCK-**-B- 37SST1A
M83513/19-E02*N	MCK-**-B- 31SRT3A	M83513/22-F02*N	MCK-**-B- 37PST1A	M83513/25-A02*P	MCK-**-P- 9SST1A
M83513/19-F02*N	MCK-**-B- 37SRT3A	M83513/22-A02*P	MCK-**-P- 9PST1A	M83513/25-B02*P	MCK-**-P- 15SST1A
M83513/19-A02*P	MCK-**-P- 9SRT3A	M83513/22-B02*P	MCK-**-P- 15PST1A	M83513/25-C02*P	MCK-**-P- 21SST1A
M83513/19-B02*P	MCK-**-P- 15SRT3A	M83513/22-C02*P	MCK-**-P- 21PST1A	M83513/25-D02*P	MCK-**-P- 25SST1A
M83513/19-C02*P	MCK-**-P- 21SRT3A	M83513/22-D02*P	MCK-**-P- 25PST1A	M83513/25-E02*P	MCK-**-P- 31SST1A
M83513/19-D02*P	MCK-**-P- 25SRT3A	M83513/22-E02*P	MCK-**-P- 31PST1A	M83513/25-F02*P	MCK-**-P- 37SST1A
M83513/19-E02*P	MCK-**-P- 31SRT3A	M83513/22-F02*P	MCK-**-P- 37PST1A	M83513/25-A03*N	MCK-**-B- 9SST1B
M83513/19-F02*P	MCK-**-P- 37SRT3A	M83513/22-A03*N	MCK-**-B- 9PST1B	M83513/25-B03*N	MCK-**-B- 15SST1B
M83513/19-A03*N	MCK-**-B- 9SRT3B	M83513/22-B03*N	MCK-**-B- 15PST1B	M83513/25-C03*N	MCK-**-B- 21SST1B
M83513/19-B03*N	MCK-**-B- 15SRT3B	M83513/22-C03*N	MCK-**-B- 21PST1B	M83513/25-D03*N	MCK-**-B- 25SST1B
M83513/19-C03*N	MCK-**-B- 21SRT3B	M83513/22-D03*N	MCK-**-B- 25PST1B	M83513/25-E03*N	MCK-**-B- 31SST1B
M83513/19-D03*N	MCK-**-B- 25SRT3B	M83513/22-E03*N	MCK-**-B- 31PST1B	M83513/25-F03*N	MCK-**-B- 37SST1B
M83513/19-E03*N	MCK-**-B- 31SRT3B	M83513/22-F03*N	MCK-**-B- 37PST1B	M83513/25-A03*P	MCK-**-P- 9SST1B
M83513/19-F03*N	MCK-**-B- 37SRT3B	M83513/22-A03*P	MCK-**-P- 9PST1B	M83513/25-B03*P	MCK-**-P- 15SST1B
M83513/19-A03*P	MCK-**-P- 9SRT3B	M83513/22-B03*P	MCK-**-P- 15PST1B	M83513/25-C03*P	MCK-**-P- 21SST1B
M83513/19-B03*P	MCK-**-P- 15SRT3B	M83513/22-C03*P	MCK-**-P- 21PST1B	M83513/25-D03*P	MCK-**-P- 25SST1B
M83513/19-C03*P	MCK-**-P- 21SRT3B	M83513/22-D03*P	MCK-**-P- 25PST1B	M83513/25-E03*P	MCK-**-P- 31SST1B
M83513/19-D03*P	MCK-**-P- 25SRT3B	M83513/22-E03*P	MCK-**-P- 31PST1B	M83513/25-F03*P	MCK-**-P- 37SST1B
M83513/19-E03*P	MCK-**-P- 31SRT3B	M83513/22-F03*P	MCK-**-P- 37PST1B	M83513/26-G01*N	MCK-**-B- 51SST1
M83513/19-F03*P	MCK-**-P- 37SRT3B	M83513/23-G01*N	MCK-**-B- 51PST1	M83513/26-G01*P	MCK-**-P- 51SST1
M83513/20-G01*N	MCK-**-B- 51SRT3	M83513/23-G01*P	MCK-**-P- 51PST1	M83513/26-G02*N	MCK-**-B- 51SST1A
M83513/20-G01*P	MCK-**-P- 51SRT3	M83513/23-G02*N	MCK-**-B- 51PST1A	M83513/26-G02*P	MCK-**-P- 51SST1A
M83513/20-G02*N	MCK-**-B- 51SRT3A	M83513/23-G02*P	MCK-**-P- 51PST1A	M83513/26-G03*N	MCK-**-B- 51SST1B
M83513/20-G02*P	MCK-**-P- 51SRT3A	M83513/23-G03*N	MCK-**-B- 51PST1B	M83513/26-G03*P	MCK-**-P- 51SST1B
M83513/20-G03*N	MCK-**-B- 51SRT3B	M83513/23-G03*P	MCK-**-P- 51PST1B	M83513/27-H01*N	MCK-**-B-100SST1
M83513/20-G03*P	MCK-**-P- 51SRT3B	M83513/24-H01*N	MCK-**-B-100PST1	M83513/27-H01*P	MCK-**-P-100SST1
M83513/21-H01*N	MCK-**-B-100SRT3	M83513/24-H01*P	MCK-**-P-100PST1	M83513/27-H02*N	MCK-**-B-100SST1A
M83513/21-H01*P	MCK-**-P-100SRT3	M83513/24-H02*N	MCK-**-B-100PST1A	M83515/27-H02*P	MCK-**-P-100SST1A
M83513/21-H02*N	MCK-**-B-100SRT3A	M83515/24-H02*P	MCK-**-P-100PST1A	M83513/27-H03*N	MCK-**-B-100SST1B
M83515/21-H02*P	MCK-**-P-100SRT3A	M83513/24-H03*N	MCK-**-B-100PST1B	M83513/27-H03*P	MCK-**-P-100SST1B

*C = Cadmium or N = Nickel (space applications only)
 **C2 = Cadmium or N1 = Nickel (space applications only)

Introduction

High Density Circular Connectors

Product Facts

- High density, light-weight Multi-Pin Circular Connectors feature a crimp contact retention method, requiring no insertion or removal tools
- Reverse gender available
- Ideal for harsh environment
- Sealed — Silicon rubber grommet/o-ring
- Unsealed — No grommet/o-ring
- Meets MIL Standards (high quality) but is not QPL qualified
- Ideally suited to applications where many conductors must be accommodated in a minimum of space with minimum weight
- MARC Series Connectors are non-magnetic



Our high density, light-weight Multi-Pin Circular Connectors are the industry's most advanced and are ideally suited to applications where many conductors must be accommodated in a minimum of space with minimum weight.

All series of connectors feature a crimp contact retention method, requiring no insertion or removal tools.

The MARC 43 Series Connectors conform to applicable performance requirements of MIL-C-26482 and has seen extensive service on many leading aerospace and ground support equipment programs.

The MARC 53 Series Connectors, designed to conform to the USAF high reliability specification MIL-C-38300, as offers high density connector performance. The positive lock coupling mechanism, combined with our exclusive floating interfacial seal, offers outstanding performance under rigorous service conditions.

The MARC 63 Series Connectors, our Bayonet Coupling Series, accommodates all insert patterns and layouts available in the MARC 43 Series Connectors, MARC 53 Series Connectors, and RMD Series Connectors. All insert assemblies are

completely interchangeable. Lighter in weight and smaller in size than any comparable connector on the market, it requires up to 50% less engagement/separation force. Conversion to bayonet coupling shell from MARC 43 Series Connectors or MARC 53 Series Connectors is done without tools by merely transferring the contacts and insert assemblies into the MARC 63 Series Connectors shell.

The newest addition to the Multi-Pin product line is the MARC 73 Series Connectors. The twist pin Circular Connector combines the lightweight, bayonet

Introduction (Continued)

coupling feature of the MARC 63 Series Connectors with the twist pin high density, center-to-center contact spacing of 0.065 [1.65] inch. The utilization of 22 AWG twist pin and socket contacts provide for 50% greater contact densities

than presently offered in the MARC 43 Series Connectors, MARC 53 Series Connectors, or MARC 63 Series Connectors.

The MQR Series is a line of circular quick disconnect connectors for rugged environmental use.

Consult Tyco Electronics for detailed information.



**SHM Receptacle
MARC 43 Series Connectors &
MARC 53 Series Connectors**



**Mated MARC 53
Series Connectors**



**SHM Receptacle
MARC 43 Series Connectors &
MARC 53 Series Connectors**



Mated MARC 63 Series Connectors



**Mated MARC 43 Series
Connectors**

MARC 43 Series Connectors

General Information

A high density (.080 [2.03] contact centers), lightweight, subminiature, cylindrical connector series featuring crimp contacts and fingertip, push-pull, quick disconnect coupling. This series conforms to the applicable performance requirements of MIL-C-26482 and is available in unsealed, environmentally sealed, and hermetic types.

A large assortment in insert arrangements — accommodating AWG 12 through 32 gauge wire and miniature coaxial cables — is available for the design engineer's choice. The contacts are

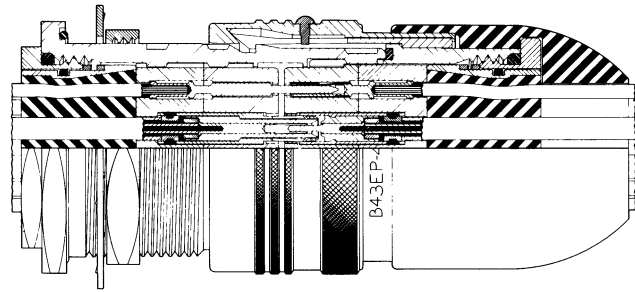

retained by shoulder entrapment and can be crimped with the standard M22520 tools, using appropriate locators. This proven series of connectors has a long history of outstanding performance

on many military and aerospace programs. MARC 43 Series Connectors are ideal for applications where high performance must be achieved at low cost.

Materials and Finishes

MARC 43 Series Connector housings and quick disconnect couplings are machined from bar stock aluminum to combine maximum strength with minimum weight. Threaded couplings are machined from non-magnetic, stainless steel bar stock for durability of the coupling threads. Contacts are manufactured from high conductivity copper alloys which have been selected for low contact resistance over the operat-

ing range of the connectors. Inserts are molded from flame-resistant, glass-filled diallyl phthalate, meeting MIL-M-14 requirements. All resilient parts are made of high temperature, silicone rubbers. Fuel resistant compounds are used where swelling affects the performance of the connector. All materials are carefully selected for their non-magnetic properties. The standard finish is clear, non-conductive anodize on

connector housings and quick disconnect couplings. For threaded coupling applications, aluminum components are hard, black anodized, and stainless steel plug coupling is passivated with black oxide finish. Conductive finish modifications include gold, cadmium, and iridium finishes. Contacts are gold plated per MIL-G-45204 requirements. See page 5071 for modification information.

Service and Performance Data

I. Electrical — Electrical Ratings

Contact Size	Current Rating		Dielectric Withstanding Voltage (RMS)	Working Voltage	
	Amperes, Max., +27°C ¹			Sea Level	70,000 ft. [21,336 m] Alt.
22 AWG	5 amps		1000	750	300
16 AWG	20 amps		1000	750	300
12 AWG	50 amps		1000	750	300
50 ohm	3 amps		1000	750	300
75 ohm	3 amps		1250	1000	300
95 ohm	3 amps		1500	1250	300

¹ Consult nomograph.

II. Mechanical — Durability: 500 Cycles Mate/Unmate. Coupling/Uncoupling Forces and Tightening Torques:

Shell Size	Coupling/Uncoupling Force (In-Lbs.) Max.	Tightening Torque (In-Lbs.)	
		Retaining Nut	Mounting Nut
A	13 [57.8 N]	20, Max. [2.26 Nm]	30-45 [3.39 Nm – 5.08 Nm]
B	17 [75.6 N]	20, Max. [2.26 Nm]	40-55 [4.52 Nm – 6.21 Nm]
C	21 [93.4 N]	20, Max. [2.26 Nm]	55-70 [6.21 Nm – 7.91 Nm]

Operating Temperature: -85°F to 257°F [-65°C to +125°C].

Contact Size	Wire Size	Conductor Dia. (Stranded) ¹	Dielectric Dia. (Teflon)	Shield Dia.	Jacket Dia. ²
22	22, 24, 26	.019-.032 .482-.813	—	—	.039-.054 .990-1.37
16 ³	16, 18, 20	.038-.061 .965-1.55	—	—	.065-.081 1.65-2.06
12	12 AWG	.071-.093 1.80-2.36	—	—	.096-.120 2.44-3.05
50 ohm	50 ohm	.013 .330 Max.	.032-.036 .813-.914	.048-.054 1.22-1.37	.065-.087 1.65-2.21
75 ohm	75 ohm	.013 .330 Max.	.060-.066 1.52-1.68	.078-.084 1.98-2.13	.096-.109 2.44-2.77
95 ohm	95 ohm	.013 .330 Max.	.100-.104 2.54-2.64	.115-.123 2.92-3.12	.137-.154 3.48-3.91

¹ Tolerance of conductor diameters required for a reliable crimp. Smaller sizes readily accommodated — consult Tyco Electronics.

² Smaller jacketed cable can be accommodated but environmental seal may be impaired. Smooth extruded jacket should be used for consistent wire sealing.

³ Size 16 AWG Contact for size 20 AWG Wire — Use Tool 010-0080-0000.

Test Data

MARC 43 Series Connectors meet the applicable performance requirements of specification MIL-C 26482 (Navy) to include the following selected test parameters listed below:

DESCRIPTION

MIL-C-26482 Test Para

TEST REQUIREMENTS

Insulation Resistance, Room and High Temp.,
Para. 4.7.3

Insulation resistance of unmated connectors shall be 5000 megohms, minimum at room temperature and 2000 megohms, minimum, at 257°F [+125°C] when measured per MIL-STD-202, Method 302, Test Condition B.

Dielectric Withstanding Voltage,
Para. 4.7.4

No evidence of dielectric breakdown or flashover when mated and unmated plugs are subjected to 1000 volts, rms, per MIL-STD-202, Method 301.

Durability,
Para. 4.7.9

Plugs and receptacles designed to withstand up to 500 cycles of engagement and separation without detrimental electrical or mechanical damage to the connectors.

Corrosion,
Para. 4.7.10

Unmated plugs and receptacles shall show no exposure of basis metal due to corrosion which would affect electrical or mechanical performance of the connectors after subjection to 24 hours exposure to salt spray atmosphere per MIL-STD 202, Method 101.

Sweep Vibration,
Mated, Para. 4.7.11

Mated connectors shall show no circuit interruptions greater than 10 microseconds during 12 hours vibration to include six sweeps in two axes at -67°F [-55°C], room temperature, and 257°F [+125°C] per MIL-STD-202, Method 204, Test Condition B. Post inspection shall show no detrimental cracking, breaking, or loosening of parts.

Moisture Resistance,
Para. 4.7.13 and 4.7.13.1

The insulation resistance of mated connectors shall exceed 100 megohms after subjection to moisture resistance testing per MIL-STD-202, Method 106.

Contact Retention,
Para. 4.7.16

Contacts shall withstand 15 lbs [66.7 N] axial load without axial displacement in excess of 0.012 [0.305] or damage to contacts or inserts when the axial load is applied to the mating end of the contacts in unmated plugs and receptacles at a rate of approximately 1 lb/sec.

Contact Arrangements¹

"A Size" Insert Layouts
(A =) Shell Size 9

Insert Arrangement²
Number of Contacts
Contact Size

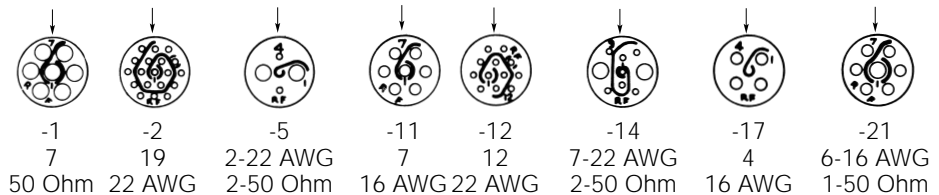

"B Size" Insert Layouts
(B =) Shell Size 12

Insert Arrangement²
Number of Contacts
Contact Size

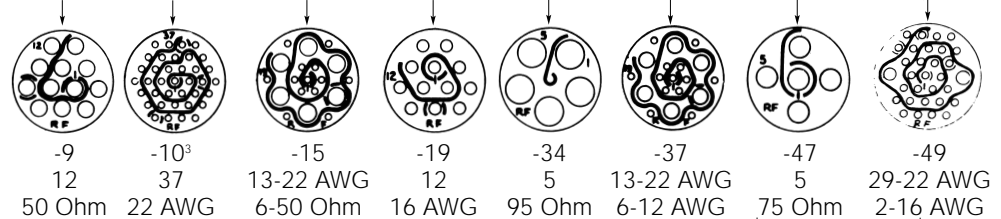

"C Size" Insert Layouts
(C =) Shell Size 15

Insert Arrangement²
Number of Contacts
Contact Size

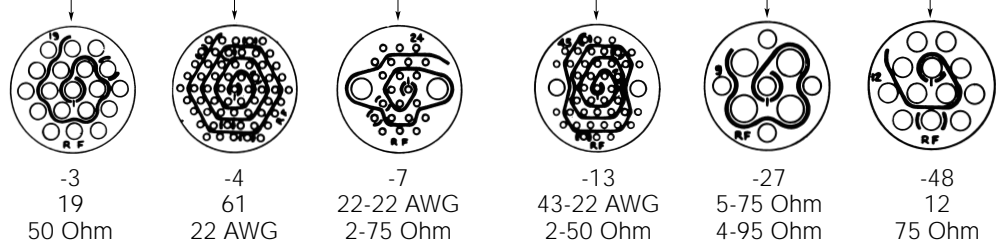

Notes: ¹ Views shown are front face view of receptacles. Front face view of plugs is mirror image of that shown.
² Arrow (↑) indicates insert top or vertical position in relation to top or vertical position of connector housings.
³ Arrangement also available in hermetic seal receptacles.

Part Number and Ordering Information

MARC 43 Series Connectors (Continued)

MARC 43 Series Connector part numbers indicate size, shape, insert layout, type of seal, style of contact and polarization. **Note:** Pin or socket (power or coaxial) contacts may be used in either plugs or receptacles. However, it is recommended that pins be placed in the receptacle when possi-

ble to take advantage of our "scuff-proof" design. (The style—pin or socket—of a coaxial contact refers to the outer contact body.)

Alternate Keying. Standard alternate polarizing key positions are shown below. Additional polarizing keyways are available upon request.

Supplemental Accessory Hardware. We also manufacture supplemental accessory hardware (protective covers, cable clamps, etc.) to adapt these connectors to almost any application. For modifications to fit your requirements, contact Tyco Electronics.

Typical Part Number

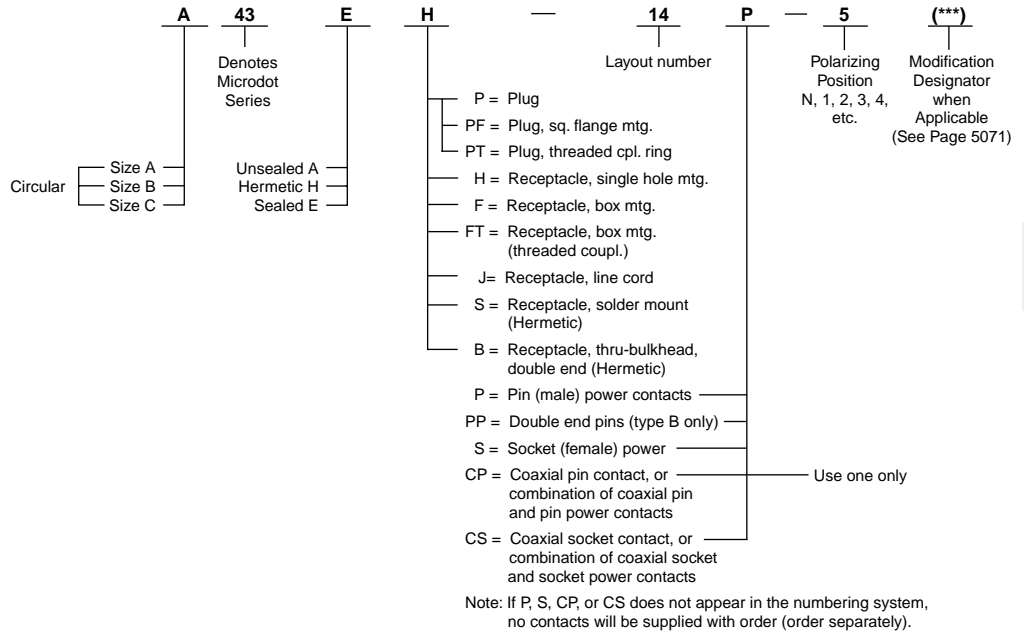

Polarizing Key Positions

All MARC 43 Series Connector multi-pin plugs and receptacles are available in alternate polarizing positions as listed below:

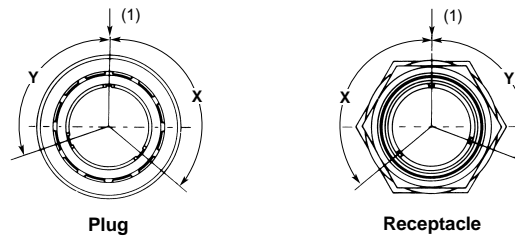

(1) Arrow (↓) indicates top or vertical position (master key-keyway) and coincides with top or vertical position of insert. This relationship remains constant with alternate polarizing key positions.

N—for Normal

Size A			Size B			Size C		
Part No.	X°	Y°	Part No.	X°	Y°	Part No.	X°	Y°
A43****N	130	110	B43****N	130	110	C43****N	130	110
A43****-1	130	150	B43****-1	130	90	C43****-1	130	90
A43****-2	90	110	B43****-2	130	145	C43****-2	130	150
A43****-3	210	110	B43****-3	105	110	C43****-3	130	170
A43****-4	130	35	B43****-4	155	110	C43****-4	190	110
A43****-5	90	230	B43****-5	80	110	C43****-5	150	110
			B43****-6	190	110	C43****-6	90	110
			B43****-7	130	170	C43****-7	70	110
			B43****-8	215	110	C43****-8	70	230
			B43****-9	80	230	C43****-9	90	230
			B43****-10	130	30	C43****-10	210	110
						C43****-11	30	110
						C43****-12	250	30
						C43****-13	130	30
						C43****-14	30	230

Configurations

Type P

Straight Plug, Push-Pull Coupling, Sealed or Unsealed (Mates with Receptacles, All Types)

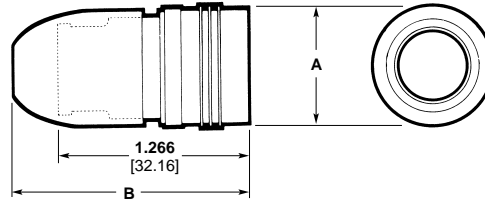

Shell Size	Dimensions	
	A	B
A	.766 19.46	1.578 40.08
B	.953 24.21	1.656 42.06
C	1.141 28.98	1.75 44.45

Type PF

Straight Plug, Square Flange Mounting, Push-Pull Coupling, Sealed or Unsealed (Mates with Receptacles, all Types.)

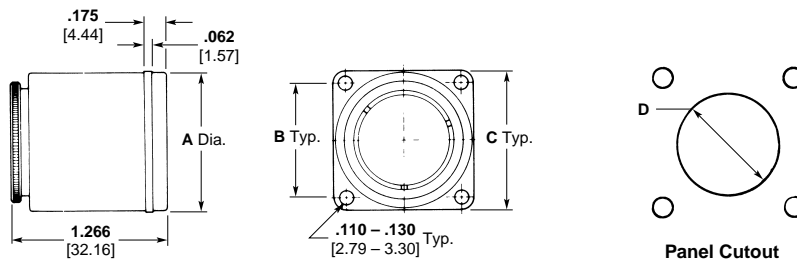
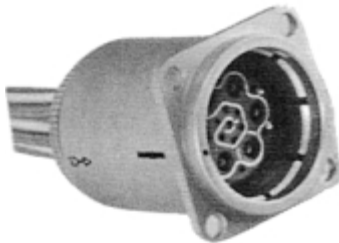

Shell Size	Dimensions			
	A	B	C	D
A	.730 18.54	.664 16.86	.875 22.23	.750 19.05
B	.920 23.37	.786 19.96	1.000 25.40	.940 23.88
C	1.110 28.19	.924 23.47	1.125 28.58	1.130 28.70

Type PT

Straight Plug, Threaded Coupling, Sealed or Unsealed (Mates with Receptacles, Types H, HH, and FT)

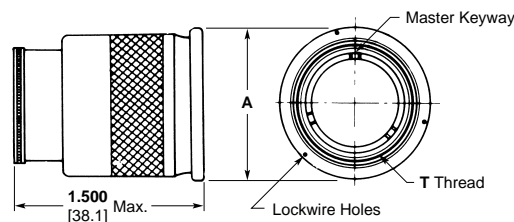

Shell Size	Dimensions	
	A	T (Class 2B)
A	.813 20.65	5/8-32 UN
B	1.000 25.40	13/16-28 UN
C	1.19 30.23	1-28 UN

MARC 43 Series Connectors (Continued)

Configurations (Continued)

Type H

Receptacle, Single Hole Mounting
Sealed or Unsealed
(Mates with Plugs, Types P, PF and PT)

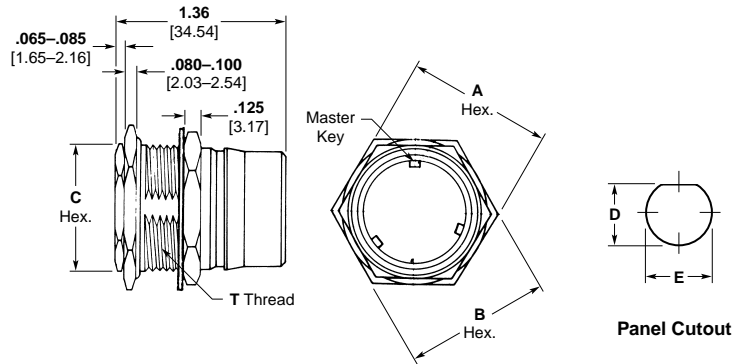
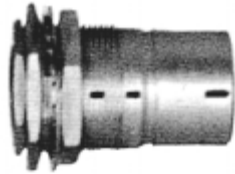

Shell Size	Dimensions					
	A	B	C	D	E	T (Class 2A)
A	.75 19.05	.687 17.45	.562 14.27	.607-.611 15.42-15.52	.625-.629 15.8-15.97	5/8-32 UN
B	.937 23.80	.875 22.23	.75 19.05	.794-.798 20.17-20.27	.812-.816 20.62-20.72	13/16-28 UN
C	1.125 28.58	1.062 26.97	.875 22.23	.975-.979 24.77-24.87	.999-1.003 25.37-25.47	1-28 UN

F: .313 [7.95] max. panel for P & PF; PT: .109 [2.77] max. panel.

Type 43F

Receptacle, Box Mounting,
Sealed or Unsealed (Mates with Plugs, Types P and PF)

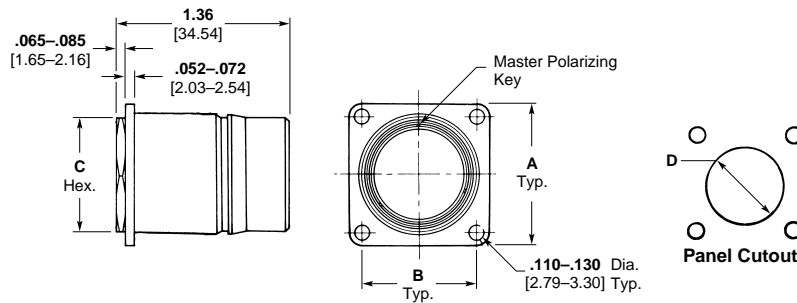
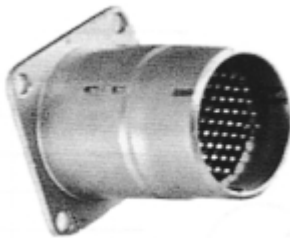

Shell Size	Dimensions			
	A	B	C	D
A	.875 22.23	.594 15.08	.562 14.27	.595 15.11
B	1.000 25.40	.786 19.96	.75 19.05	.783 19.89
C	1.125 28.58	.906 23.01	.875 22.23	.960 24.38

Note: Unless otherwise shown, tolerances are: Decimals ±.015 [±.381], fractions ±1/32.

Configurations (Continued)

Type FT

Receptacle, Box Mounting, Threaded Coupling, Sealed or Unsealed (Mates with Plugs, Types PT, P and PF)

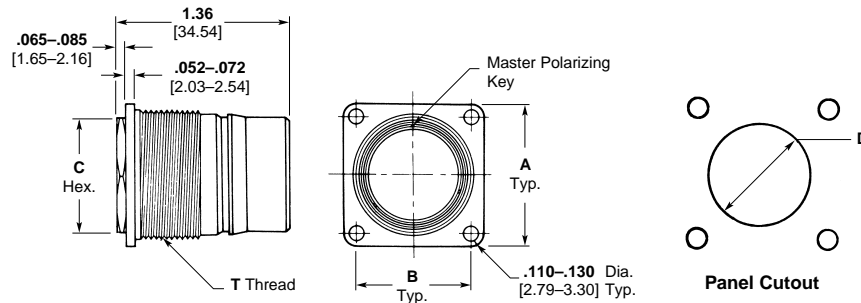
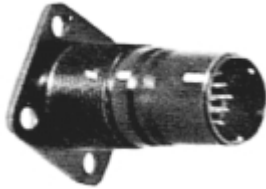

Shell Size	Dimensions			
	A	B	C	T (Class 2A)
A	.875 22.23	.594 15.08	.562 14.27	5/8-32 UN 16.38
B	1.000 25.40	.786 19.96	.75 19.05	13/16-28 UN 21.13
C	1.125 28.58	.906 23.01	.875 22.23	1-28 UN 25.90

Max. panel thickness is .125 [3.18].

Type J

Receptacle, Line Cord, Sealed or Unsealed (Mates with Plugs, Types P and PF)

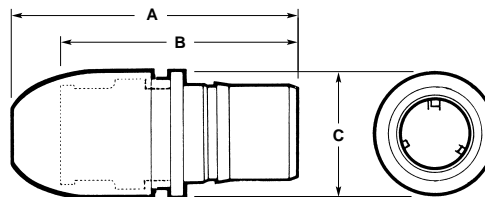

Shell Size	Dimensions		
	A	B	C
A	1.703 43.26	1.36 34.54	.766 19.46
B	1.781 45.24	1.36 34.54	.953 24.21
C	1.875 47.63	1.36 34.54	1.141 28.98

Note: Unless otherwise shown, tolerances are: Decimals ± 0.015 [± 381], fractions $\pm 1/32$.

Accessories
Cable Clamps

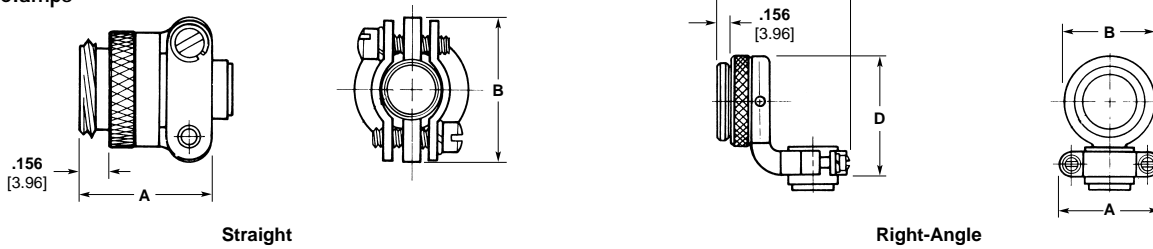

Shell Size	Part No.	A (Max.)	B (Max.)
A	086-0099-00X1	.704 17.88	.750 19.05
B	086-0100-00X1	.773 19.63	.932 23.67
C	086-0101-00X1	.829 21.05	1.078 27.38

Shell Size	Part No.	A (Max.)	B (Max.)	C (Max.)	D (Max.)
A	086-0103-00X1	.737 18.72	.600 15.24	1.100 27.94	.879 22.33
B	086-0104-00X1	.913 23.19	.770 19.55	1.250 31.75	1.067 27.10
C	086-0105-00X1	1.048 26.62	.962 24.43	1.469 37.31	1.233 31.32

Contacts (see pages 5086 and 5087)

Contact Size	Pin Part No.	Socket Part No.
22 AWG	083-0009-00R4	082-0464-00Y9
16 AWG	083-0158-00R4	082-0113-00T1
12 AWG	083-0173-00R4	082-0132-00T1
50 ohm Coaxial (Solder Type)	084-0024-00T2	084-0027-00T2
50 ohm Coaxial (Crimp Type)	141-1500-0001	142-1500-0001
75 ohm Coaxial	084-0025-00T2	084-0028-00T2
95 ohm Coaxial	084-0026-00T2	084-0029-00T2

Contact Cavity Sealing Plugs (see page 5088)

Contact Size	Sealed Connector Part No.	Unsealed Connector Part No.
22 AWG	086-0055-0000	086-0001-0000
16 AWG	086-0056-0000	086-0014-0000
12 AWG	086-0057-0000	086-0015-0000
50 ohm Coaxial	086-0058-0000	086-0061-0000
75 ohm Coaxial	086-0059-0000	086-0062-0000
95 ohm Coaxial	086-0060-0000	086-0063-0000

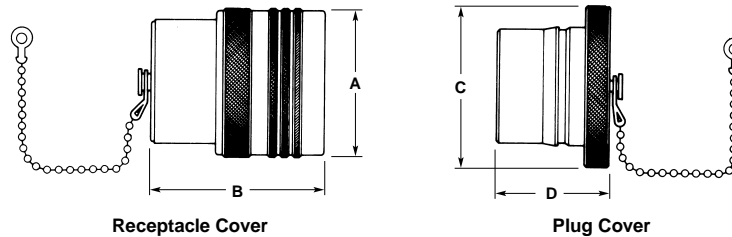

Protective Covers

Shell Size	Receptacle Cover Part No. ¹		Plug Cover Part No. ¹		Dimensions (Max.)			
	With Chain	Without Chain	With Chain	Without Chain	A	B	C	D
A	086-0049-00J2	086-0073-00P1	086-0052-00J2	086-0076-00P1	.766 19.46	.950 24.13	.969 24.62	.913 23.19
B	086-0050-00J2	086-0074-00P1	086-0053-00J2	086-0077-00P1	.953 24.21	.950 24.13	1.156 29.36	.913 23.19
C	086-0051-00J2	086-0075-00P1	086-0054-00J2	086-0078-00P1	1.141 28.98	.950 24.13	1.344 34.14	.913 23.19

¹ For threaded plug (PT) and receptacle (FT) covers, consult Tyco Electronics. Wire rope/lanyard attachments and plastic protective caps also available, consult Tyco Electronics.

Modifications

The MARC 43 Series Connector modification identification system provides alteration of standard MARC 43 Series Connectors to include special finishes, accessories, MARC 53 Series Connector housings, and custom quality assurance provisions — processing, testing, serialization, traceability. Consult your sales representative or Tyco Electronics for additional modification information.

Standard modifications include:

- (009): MARC 43 Series Connector, anodized finish — black.
- (048): MARC 43 Series Connector, iridite finish — gold.
- (056): MARC 43 Series Connector, cadmium plated — clear.
- (057): MARC 43 Series Connector including cable clamp, straight type.
- (078): MARC 43 Series Connector insert arrangement plus MARC 53 Series Connector positive lock coupling.
- (094): MARC 43 Series Connector coaxial insert arrangement to include all-crimp coaxial contacts plus MARC 53 Series Connector positive lock coupling.
- (098): MARC 43 Series Connector connector including cable clamp, right-angle type.

MARC 53 Series Connectors

General Information

The MARC 53 Series Connector family represents a major advancement in the design of high density (.080 [2.03] contact centers), sub-miniature, power and coaxial contact connectors. The MARC 53 Series Connectors consists of two connector styles — the Military approved MD53 featuring shoulder entrapped contacts, and the new RMD53 utilizing rear insertable/removable contacts. MARC 53 Series Connectors combine positive lock — the rugged, push-pull, lock-coupling mechanism — with the unique positive seal multiple sealing system.

Positive lock is our new finger-tip, push-pull coupling with the safety lock feature, and is the only connector made with positive "blind mating" indication. When the plug is fully engaged, the coupling ring can be rotated 45° to the safety lock position; if the plug is not

completely engaged, the coupling ring cannot be turned to the safety lock position. Consequently, under "blindmating" conditions, it is always possible to determine if the plug is properly engaged without visual reference, damage, or accidental disengagement.

The environmental integrity is guaranteed by multiple seal construction using silicone rubber "O" rings and a floating, voidless insert construction. The floating insert design allows the inserts to move within the connector housing to control interfacial sealing pressure in spite of tolerance accumulation, and a compression interfacial seal with minimum engaging force. Both the primary "O" ring system and the continuous dielectric construction withstand the MIL-C-38300A altitude breathing test. The sealing system meets the air leakage requirements of not more than 1 cubic inch

of air per hour at a 30 P.S.I. pressure differential. This redundant sealing method is indicative of the inherent reliability built into our connectors.

MARC 53 Series Connector power contacts are manufactured from high grade copper alloys, and are designed to be crimped with standard M22520 tooling using subminiature contact locators.

MARC 53 Series Connectors incorporate hard insulators in both the plug and receptacle inserts for exceptional contact stability. Shoulder entrapment positively retains the front insertable MD53 contacts between the front and rear insulators. The new RMD53 contacts are rear insertable and removable and are retained within the connector insulators by clips which can be visually inspected. No insertion or extraction tools are

required for either the MD53 or RMD53 contacts using nominal size wire.

MARC 53 Series Connectors are truly field serviceable... no special tools are required for maintainability. In addition, connector subcomponents damaged through handling or misuse can be procured separately generally without the need to scrap entire connector units.

Weight reductions as high as 67% are achieved without loss of performance.

MARC 53 Series Connectors are available in both environmental and hermetic styles. In addition to the positive lock plug, a threaded coupling plug is also available. Part numbers for configurations offering various finishes and accessories plus other design variations to satisfy special requirements are also available.

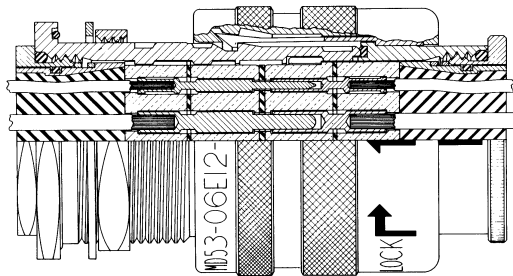

MD53
shoulder entrapped contacts

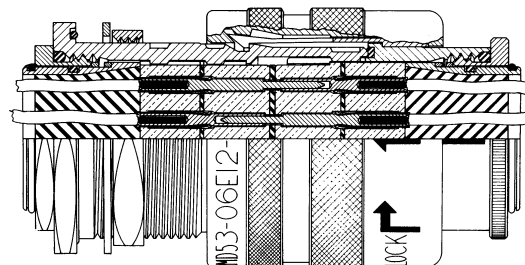

RMD53
rear insertable contacts

Materials and Finishes

Housings and quick disconnect couplings are machined from bar stock aluminum to combine maximum strength with minimum weight. Threaded couplings are machined from non-magnetic, stainless steel bar stock for durability of the coupling threads. Contacts are manufactured from high conductivity copper alloys

which have been selected for low contact resistance over the operating range of the connectors. Inserts are molded from flame-resistant, glass-filled diallyl phthalate, meeting MIL-M-14 requirements. All resilient parts are made of high-temperature, silicone elastomers. Fuel resistant compounds are used where swelling affects

the performance of the connector. All materials are selected for their non-magnetic properties.

The standard finish is hard black, non-conductive, anodized finish on connector housings and quick disconnect couplings; stainless steel threaded coupling is passivated with black oxide finish. Conductive finish

modifications include gold finish and electroless nickel finish. Multi-finish modifications for connector plugs include black anodized disconnect coupling with conductive finish on shell grounding members. Contacts are gold plated per MIL-G-45204 requirements. See Page 5081 for modification information.

MARC 53 Series Connectors (Continued)

I. Electrical — Electrical Ratings

Contact Size	Current Rating (Amperes, Max., 81°F [+27°C])	Dielectric Withstanding Voltage (RMS)	Working Voltage		Contact Resistance (Millivolts, Max.)
			Sea Level	110,000 ¹ Ft. Alt.	
22 AWG	5	1000	750	300	15
16 AWG	20	1000	750	300	20

¹ 10,000 ft equals 33,528 m altitude.

Wire Sizes Accommodated

Contact Size	Cond. Dia. (Stranded) ¹	Jacket Size ²
22 AWG	.019-.032 .483-.813	.039-.054 .991-1.37
16 AWG	.038-.061 .965-1.55	.065-.081 1.65-2.05

¹ Tolerance of conductor diameters required for a reliable crimp. Smaller sizes readily accommodated — consult Tyco Electronics.

² Smaller jacketed cable can be accommodated but environmental seal may be impaired. Smooth extruded jacket should be used for consistent wire sealing.

Insulation Resistance: 5000 megohms, minimum, at room ambient conditions.

II. Mechanical — Durability: 500 Cycles Mate/Unmate.

Coupling/Uncoupling Forces and Tightening Torques:

Shell Size	Coupling/Uncoupling Force (In-Lbs.) Max.	Tightening Torque (In-Lbs.)	
		Retaining Nut	Mounting Nut
9	18 [80.07 N]	20 [2.26 Nm], Max.	30-45 [3.39 – 5.08 Nm]
12	22 [97.86 N]	20 [2.26 Nm], Max.	40-55 [4.52 – 6.21 Nm]
15	27 [120.10 N]	20 [2.26 Nm], Max.	55-70 [6.21 – 7.91 Nm]
18	32 [142.34 N]	20 [2.26 Nm], Max.	70-85 [7.91 – 9.60 Nm]

Operating Temperature: -67°F to 257°F [-55°C to +125°C]
 Connector Mated Length: MD Plug (06) mated to MD Receptacles (00) (01) (02) (12): 2.031 [51.58], max. RMD Plug (06) mated to RMD Receptacles: 2.217 [56.31], max.

Test Data

MARC 53 Series Connectors exceed the requirements of specification MIL-C-38300A (USAF) as detailed in the applicable M38300A (USAF) military specification sheets.

MARC 53 Series Connectors meet the following selected test parameters as specified below:

DESCRIPTION MIL-C-38300 Test Para	TEST REQUIREMENTS
Contact Retention Para. 4.10.3	MD Contacts shall withstand 15 lbs [66.72 N] axial load and RMD contacts 10 lbs [44.48 N] axial load without axial displacement in excess of 0.012 [.305] or damage to contacts or inserts when the axial load is applied to the mating end of the contacts in unmated plugs and receptacles at a rate of approximately 1 lb/sec. [4.45 N].
Contact Resistance Para. 4.10.8	The potential drop across normally mated contacts shall not exceed 25 mv under room ambient and high temperature service conditions when measured as specified in MIL-C-26636, Fig. 2, with maximum rated current.
Dielectric Withstanding Voltage, Altitude and Sea Level Para. 4.10.10	No evidence of dielectric breakdown or flashover when mated and unmated plugs are subjected to 645 and 180 volts RMS, respectively, at altitudes up to 110,000 feet [33,528 m] and 1000 volts RMS at sea level.
Insulation Resistance, Room and High Temp. Para. 4.10.13 and 4.10.13.1	Insulation resistance of mated plugs and receptacles shall be 5000 megohms, minimum, at room temperature and 1000 megohms, minimum, at 257°F [+125°C] when measured per MIL-STD-202, Method 302, Test Condition B.
Coupling and Uncoupling Para. 4.11.3	Plugs and receptacles shall withstand up to 500 cycles of engagement and separation (locking mechanism actuated with each cycle) without detrimental damage to plugs or receptacles or not satisfying subsequent tests of MIL-C-38300.
Fluid Immersion Para. 4.11.5	Mating and unmating forces shall not exceed 27 lbs, [120.10 N] maximum, (15 shell size) after fully wired plugs and receptacles are immersed for 20 hours, each, in hydraulic fluid (MIL-H-5606) and high temperature lubricating oil (MIL-L-9236) followed by a one-hour dry.
Sweep Vibration, Mated Para. 4.11.6	Mated connectors shall show no circuit interruptions greater than one microsecond during 12 hours vibration to include six sweeps in each axis at extreme temperatures of -85°F [-65°C] and 257°F [+125°C] per MIL-STD-202, Method 204, Test Condition D. Post inspection shall show no detrimental cracking, breaking, or loosening of parts.
Moisture Resistance Para. 4.11.8	The insulation resistance of mated connectors shall exceed 1000 megohms after subjection to moisture resistance testing per MIL-STD-202, Method 106, as amended by MIL-C-38300.
Altitude Breathing Para. 4.11.12	The insulation resistance of wired and mated connectors shall be 5000 megohms, minimum, and there shall be no flashover or breakdown at a test voltage of 1000 volts RMS after the third cycle and while immersed in 5% salt water solution at 68°F [20°C] and room ambient pressure pressure at 68°F [20°C].
Salt Spray Para. 4.11.13	Unmated plugs and receptacles shall show no excessive corrosion which would detrimentally affect the electrical and mechanical performance of the connectors after subjection to 24 hours exposure to salt spray atmosphere per MIL-STD-202, Method 101.

MARC 53 Series Connectors (Continued)

Contact Arrangements ^{1,2}

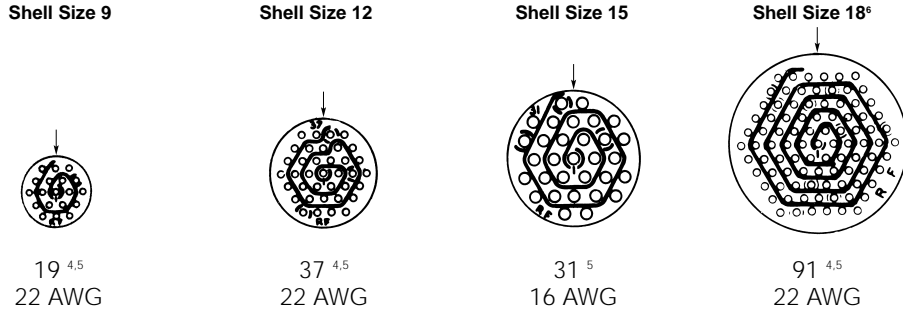

Insert Arrangement ³
Number of Contacts
Contact Size

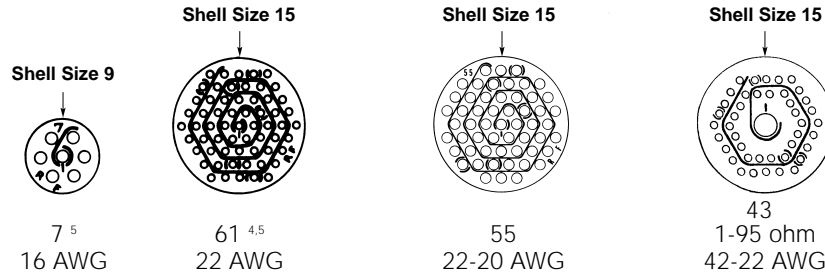

Insert Arrangement ³
Number of Contacts
Contact Size

¹ Views shown are front face view of receptacles. Front face view of plugs is mirror image of that shown.
² In addition to those inserts shown, MARC 43 Series Connector inserts may be utilized in MARC 53 Series Connector housings. See page 5071, MARC 43 Series Connector modifications.
³ Arrow (↓) indicates insert top or vertical position in relation to top or vertical position of connector housings.
⁴ Arrangement also available in RMD style.
⁵ Arrangement also available in hermetic seal receptacles.
⁶ Arrangement available in 06, 00, 01.

Part Number and Ordering Information

MARC 53 Series Connector part numbers indicate size, shape, insert layout, type of seal, style of contact and polarization.

Note: Pin or socket (power or coaxial) contacts may be used in either plugs or receptacles. However, it is recommended that pins be placed in the receptacles when possible to take advantage of our "scuff-proof" design.

Alternate Keying — Standard alternate polarizing key positions are shown below. Additional polarizing keyways are available upon request.

Supplemental Accessory Hardware — We also manu-

facture supplemental accessory hardware (protective covers, shield adapters, etc.) to adapt these connectors to almost any application. For modifications to fit your requirements, contact Tyco Electronics.

Typical Part Number

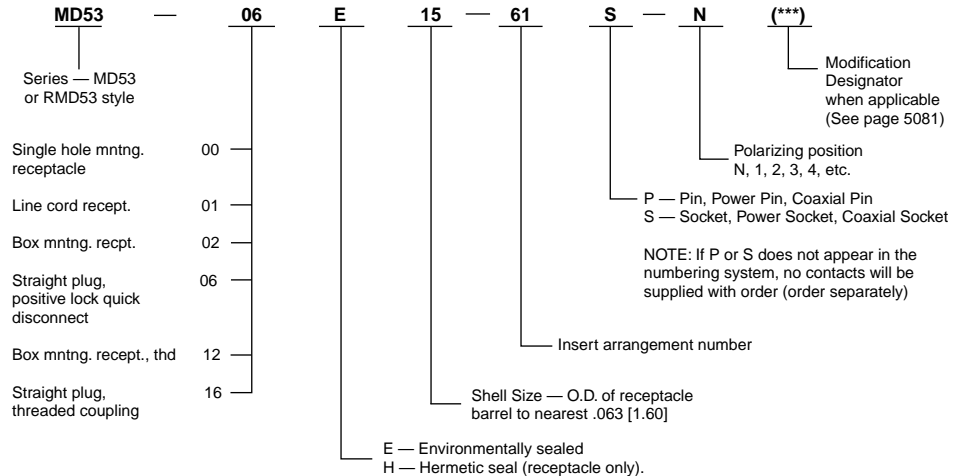

MARC 53 Series Connectors (Continued)

Polarizing Key Positions

All of our multi-pin plugs and receptacles are available in alternate polarizing positions as listed below:

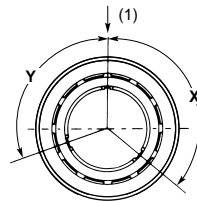

Plug
(Shell sizes 9, 12, 15 only)

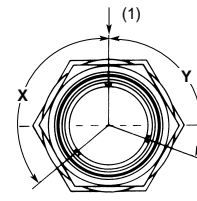

Receptacle
(Shell sizes 9, 12, 15 only)

Shell Size 9		
Part No.	X°	Y°
(R) MD53-***9-***-N	130	110
(R) MD53-***9-***-1	130	150
(R) MD53-***9-***-2	90	110
(R) MD53-***9-***-3	210	110
(R) MD53-***9-***-4	130	35
(R) MD53-***9-***-5	90	230

Shell Size 12		
Part No.	X°	Y°
(R) MD53-***12-***-N	130	110
(R) MD53-***12-***-1	130	90
(R) MD53-***12-***-2	130	145
(R) MD53-***12-***-3	105	110
(R) MD53-***12-***-4	155	110
(R) MD53-***12-***-5	80	110
(R) MD53-***12-***-6	190	110
(R) MD53-***12-***-7	130	170
(R) MD53-***12-***-8	215	110
(R) MD53-***12-***-9	80	230
(R) MD53-***12-***-10	130	30

Shell Size 15		
Part No.	X°	Y°
(R) MD53-***15-***-N	130	110
(R) MD53-***15-***-1	130	90
(R) MD53-***15-***-2	130	150
(R) MD53-***15-***-3	130	170
(R) MD53-***15-***-4	190	110
(R) MD53-***15-***-5	150	110
(R) MD53-***15-***-6	90	110
(R) MD53-***15-***-7	70	110
(R) MD53-***15-***-8	70	230
(R) MD53-***15-***-9	90	230
(R) MD53-***15-***-10	210	110
(R) MD53-***15-***-11	30	110
(R) MD53-***15-***-12	250	30
(R) MD53-***15-***-13	130	30
(R) MD53-***15-***-14	30	230

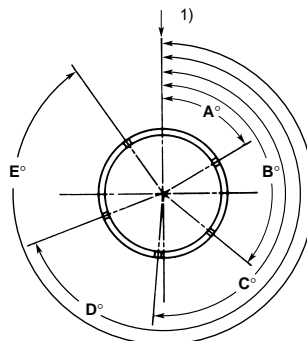

Plug
(Shell size 18 only)

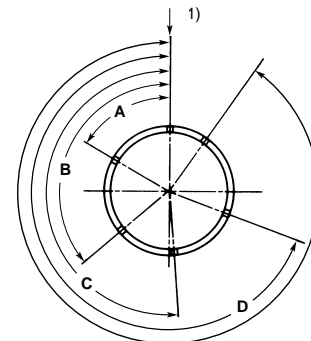

Receptacle
(Shell size 18 only)

Shell Size 18					
Part No.	A°	B°	C°	D°	E°
(R) MD53-***18-***-N	60	130	185	250	325
(R) MD53-***18-***-1	70	130	205	270	320
(R) MD53-***18-***-2	55	130	210	250	310
(R) MD53-***18-***-3	50	130	190	235	305
(R) MD53-***18-***-4	75	125	190	250	320
(R) MD53-***18-***-5	80	150	205	250	300
(R) MD53-***18-***-6	50	90	175	250	315
(R) MD53-***18-***-7	70	120	175	250	295
(R) MD53-***18-***-8	70	130	205	260	325
(R) MD53-***18-***-9	35	90	130	215	285
(R) MD53-***18-***-10	75	140	210	250	310

⁽¹⁾ Arrow (↑) indicates top or vertical position (master key/keyway) and coincides with top or vertical position of insert shown on page 5067. This relationship remains constant with alternate polarizing key positions.
(R) Rear insertable and removable.

MARC 53 Series Connectors (Continued)

Configurations

MD53-06E/RMD53-06E

Straight Plug, positive lock
Coupling, Environmental
(Mates with Receptacles,
All Types)

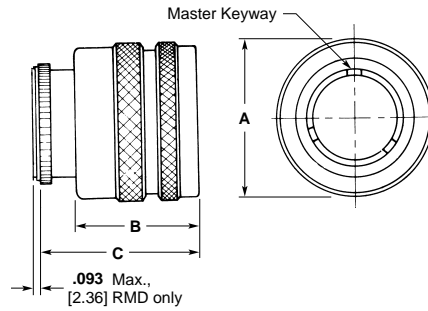

Shell Size	Dimensions		
	A	B (Max.)	C (Max.)
9	.890 22.60	1.000 25.4	1.281 32.54
12	1.078 27.38	1.000 25.4	1.281 32.54
15	1.262 32.05	1.000 25.4	1.281 32.54
18	1.577 40.06	1.000 25.4	1.281 32.54

MD53-16E/RMD53-16E

Straight Plug, Threaded
Coupling, Environmental
(Mates with Receptacles,
Types 00 and 12; Not avail-
able in 18 Shell Size)

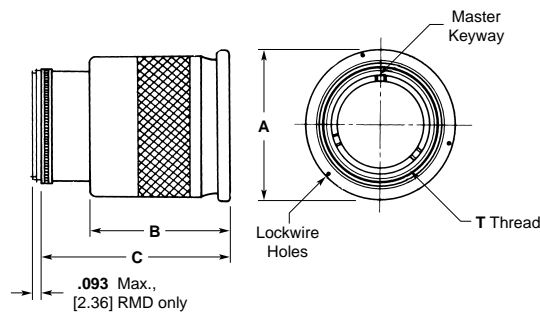

Shell Size	Dimensions			
	A	B (Max.)	C (Max.)	T (Class 2B)
9	.812 20.62	1.125 28.57	1.500 38.1	1/8-32UN
12	1.000 25.4	1.125 28.57	1.500 38.1	13/16-28UN
15	1.187 30.15	1.125 28.57	1.500 38.1	1-28UN
18	1.437 36.50	1.125 28.57	1.437 36.50	1-1/4-28UN

MARC 53 Series Connectors (Continued)

Configurations (Continued)

MD53-00E/RMD53-00E

Receptacle, Single Hole Mounting, Environmental (Mates with Plugs, Type 06 and 16)

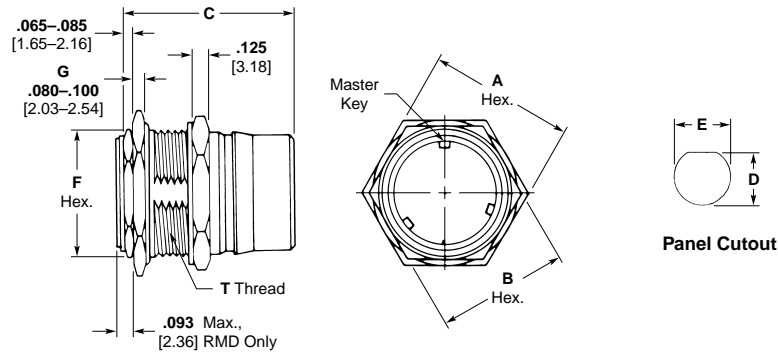

Shell Size	Dimensions							T (Class 2A)
	A	B	C	D	E	F	G	
9	.75 19.05	.687 17.45	1.360 34.54	.607-.611 15.42-15.52	.625-.629 15.87-15.97	.563 14.30	.090 2.29	5/8-32NS
12	.937 23.80	.875 22.23	1.360 34.54	.794-.798 20.17-20.27	.812-.816 20.62-20.73	.75 19.05	.090 2.29	13/16-28NS
15	1.125 28.58	1.062 26.97	1.360 34.54	.975-.979 24.76-24.86	.999-1.003 25.37-25.48	.875 22.23	.090 2.29	1-28UNS
18	1.625 41.28	1.375 34.93	1.360 34.54	1.214-1.218 30.83-30.94	1.251-1.255 31.77-31.87	1.125 28.58	.125 3.18	1-1/4-28UN

Note: .313 [7.95] Maximum Panel Thickness when mated with a positive lock 06 Plug.
.109 [2.77] Maximum Panel Thickness when mated with threaded 16 Plug.

MD53-01E/RMD53-01E

Receptacle, Line Cord, Environmental (Mates with Plug, Type 06)

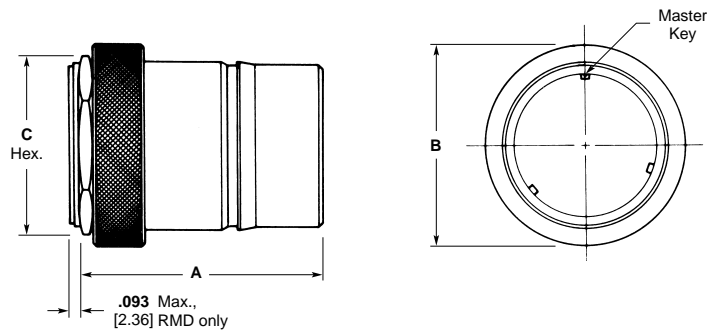

Shell Size	Dimensions		
	A (Max.)	B (Max.)	C
9	1.360 34.54	.766 19.46	.562 14.27
12	1.360 34.54	.953 24.21	.75 19.05
15	1.360 34.54	1.141 28.98	.875 22.23
18	1.360 34.54	1.578 40.08	1.125 28.58

Note: Unless otherwise shown, tolerances are: decimals ± .015 [±.381]; fractions ± 1/32.

MARC 53 Series Connectors (Continued)

Configurations (Continued)

MD53-02E/RMD53-02E

Receptacle, Box Mounting, Environmental (Mates with Plug, Type 06)

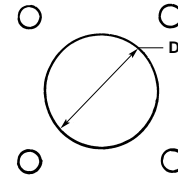
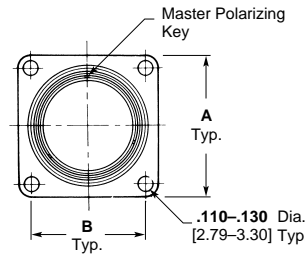
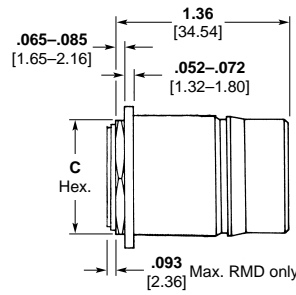
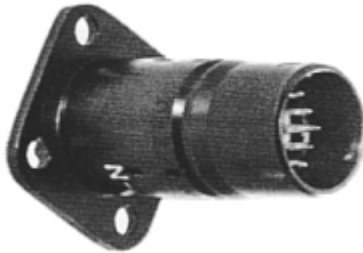

Panel Cutout

.375 [9.53] Max. Panel Thickness for rear-mount applications.

Shell Size	Dimensions			
	A	B	C	D
9	.875 22.23	.594 15.09	.563 14.30	.595 15.11
12	1.000 25.40	.786 19.96	.75 19.05	.783 19.89
15	1.125 28.58	.906 23.01	.875 22.23	.960 24.38
18	1.344 34.14	1.062 26.97	1.125 28.58	1.212 30.78

MD53-12E/RMD53-12E
Threaded Coupling

Receptacle, Box Mounting, Environmental (Mates with Plugs, Type 06 and 16; not available in 18 Shell Size)

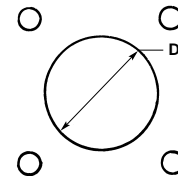
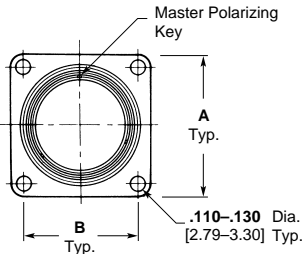
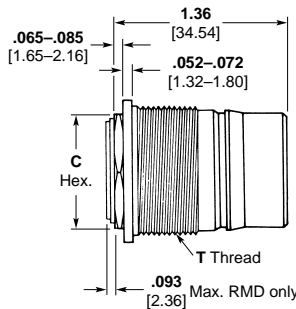
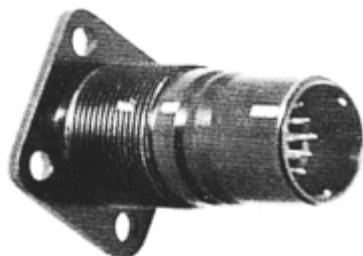

Panel Cutout

.125 [3.18] Max. Panel Thickness when mated with threaded 16 Plug for rear mount applications.

Shell Size	Dimensions				
	A	B	C	T (Class 2A)	D
9	.875 22.23	.594 15.09	.563 14.30	5/8-32UN	.645 16.38
12	1.000 25.40	.786 19.96	.75 19.05	13/16-28UN	.832 21.13
15	1.125 28.58	.906 23.01	.875 22.23	1-28UN	1.020 25.91

Note: Unless otherwise shown, tolerances are: decimals ± .015 [±.381]; fractions ± 1/32.

MARC 53 Series Connectors (Continued)

Accessories

Test Adapter

The test adapter accessory is utilized primarily as a connector simulator to preserve the end-use connector where this connector would be subjected to extensive testing, matings, or probings. The test adapter, when mated, provides the exact mating interface as that of the end-use connector and is completely field serviceable.

Test Adapter Product Part Number System

How to Specify

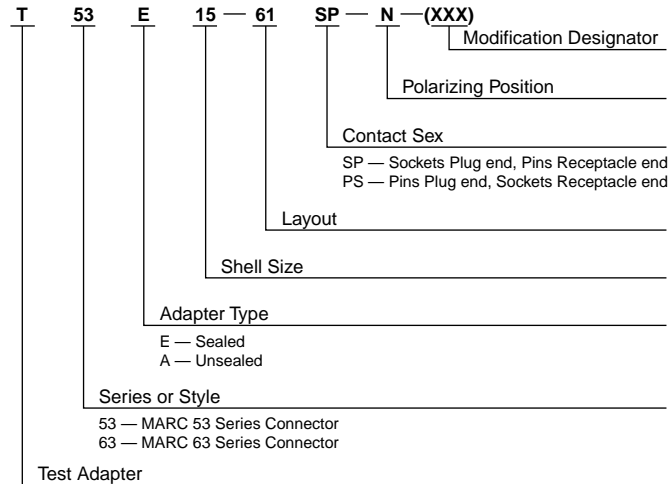

Shell Size	Dimension	
	A (Max.)	B (Max.)
9	.906 23.01	2.670 67.82
12	1.094 27.79	2.670 67.82
15	1.281 32.54	2.670 67.82
18	1.594 40.49	2.670 67.82

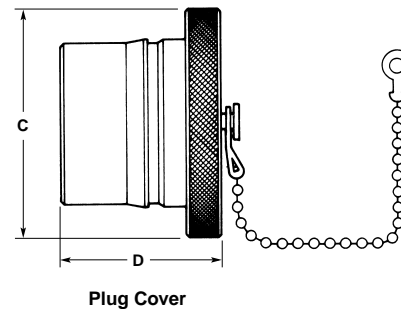
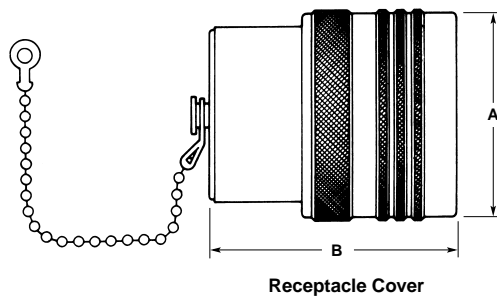
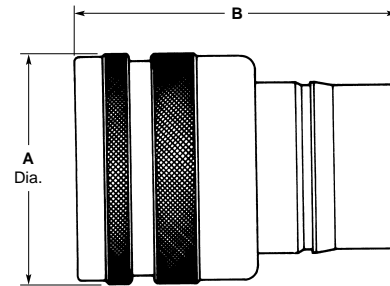

Protective Covers

Shell Size	Receptacle Cover Part No. ¹		Plug Cover Part No. ¹		Dimensions (Max.)			
	With Chain	Without Chain	With Chain	Without Chain	A	B	C	D
9	086-0049-00AL	086-0073-00W3	086-0052-00L6	086-0076-00P2	.766 19.46	.950 24.13	.969 24.61	.913 23.19
12	086-0050-00AL	086-0074-00W3	086-0053-00L6	086-0077-00P2	.953 24.21	.950 24.13	1.156 29.36	.913 23.19
15	086-0051-00AL	086-0075-00W3	086-0054-00L6	086-0078-00P2	1.141 28.98	.950 24.13	1.344 34.14	.913 23.19
18	086-0146-00AL	086-0139-00W3	086-0147-00L6	086-0140-00P2	1.578 40.08	1.000 25.4	1.781 45.24	.913 23.19

¹ For threaded plug (PT) cover, consult Tyco Electronics. Wire rope/lanyard attachments and plastic protective caps also available, consult Tyco Electronics.

Accessories (Continued)

Cable Clamps

Shell Size	Clamp Part No.		A	B	T Thd. 2A
	MD	RMD			
9	086-0099-00F5	086-0175-00F3	.704 17.88	.750 19.05	1/2-20 UNF
12	086-0100-00F5	086-0176-00F3	.773 19.63	.932 23.67	11/16-24 UNEF
15	086-0101-00F5	086-0177-00F3	.829 21.06	1.078 27.38	13/16-24 UNEF
18	086-0142-00F5	086-0178-00F3	.890 22.61	1.250 31.75	1-28 UN

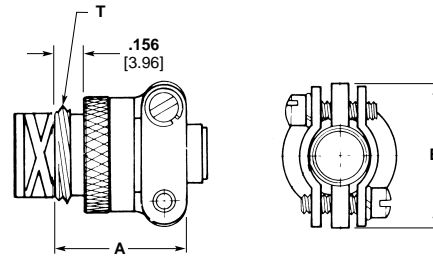

Straight

Shell Size	Clamp Part No.		A	B (Max.)	C (Max.)	D	T Thd. 2A
	MD	RMD					
9	086-0103-00F5	086-0179-00F3	.737 18.72	.600 15.24	1.100 27.94	.879 22.32	1/2-20 UNF
12	086-0104-00F5	086-0180-00F3	.913 23.19	.775 19.68	1.250 31.75	1.067 27.10	11/16-24 UNEF
15	086-0105-00F5	086-0181-00F3	1.048 26.62	.962 24.43	1.469 37.31	1.233 31.32	13/16-20 UNEF
18	086-0143-00F5	086-0182-00F3	1.225 31.12	1.185 30.01	1.550 39.37	1.550 39.37	1-28 UN

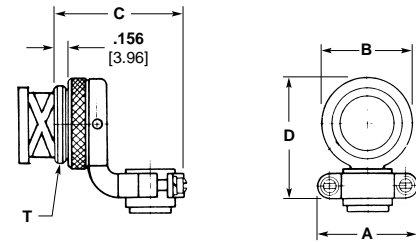

Right-Angle

Contacts (see pages 5086 and 5087)

Contact Size	Pin Part No.		Socket Part No.	
	MD	RMD	MD	RMD
22 AWG	083-0009-00R4	083-1200-00R4	082-0464-00Y9	082-0462-00Y9
16 AWG	083-0158-00R4	—	082-0113-00T1	—

Note: Standard packaging includes same quantity of contacts as contact cavities in insert.

Contact Cavity Sealing Plugs (see page 5088)

Contact Size	Standard Length Part No.		Short Length Part No.	
	MD	RMD	MD	RMD
22 AWG	086-0055-0000	086-0148-0000	082-0009-0000	086-0009-0000
16 AWG	086-0056-0000	—	082-0010-0000	—

Note: Standard length plug occupies contact cavity and wire sealing grommet. Short length plug occupies wire sealing grommet only (to be used behind non-wired contacts and in plugs which mate to hermetic receptacles).

Modifications

We offer a unique modification identification system which provides alteration of standard MARC 53 Series Connectors to include special finishes, accessories, MARC 43 Series Connector contact arrangements, and custom quality assurance provisions — processing, testing, serialization, traceability. Consult Tyco Electronics for additional modification information.

Standard modifications include:

- (503): MARC 53 Series Connector including cable clamp, straight type
- (504): MARC 53 Series Connector including cable clamp, right-angle type
- (506): MARC 53 Series Connector, gold finish

- (507): MARC 53 Series Connector, electroless nickel finish
- (508): MARC 53 Series Connector, black anodized coupling ring, gold over electroless nickel housings, retaining nuts and hardware.

MARC 63 Series Connectors RMD63 Performance Data

MARC 63 Series Connectors,0 RMD63 Series meet or exceed the performance requirements of specification MIL-C-38300A (USAF) as detailed in the M38300A (USAF) military specification sheets covering the MARC 53 Series Connectors. Tyco Electronics can supply detailed, cross reference information. MARC 63 Series Connectors, RMD63 Series meet the following selected test parameters as specified below:

DESCRIPTION	TEST REQUIREMENTS
Contact Retention	Contacts are to withstand 15 lbs. [66.72 N] axial load and RMD contacts 10 lbs. [44.48 N] axial load without axial displacement in excess of 0.012 [.305] or damage to contacts or inserts when the axial load is applied to the mating end of the contacts in unmated plugs and receptacles at a rate of approximately 1 lb/sec. [4.45 N].
Contact Resistance	The potential drop across normally mated contacts shall not exceed 25 mv under room ambient and high temperature service conditions when measured as specified in MIL-C-26636, Fig. 2, with maximum rated current.
Dielectric Withstanding Voltage, Altitude and Sea Level	No evidence of dielectric breakdown or flashover when mated and unmated plugs are subjected to 645 and 180 volts RMS, respectively, at altitudes up to 110,000 [33,528 m] feet and 1000 volts RMS at sea level.
Insulation Resistance, Room and High Temp.	Insulation resistance of mated plugs and receptacles shall be 5000 megohms, minimum, at room temperature and 1000 megohms, minimum, at 257°F [+125°C] when measured per MIL-STD-202, Method 302, Test Condition B.
Coupling and Uncoupling	Plugs and receptacles shall withstand up to 500 cycles of engagement and separation without detrimental damage to plugs or receptacles or not satisfying subsequent tests of MIL-C-38300.
Fluid Immersion	Mating and unmating forces shall not exceed 27 lbs. [120.10 N], maximum, (15 shell size) after fully wired plugs and receptacles are immersed for 20 hours, each, in hydraulic fluid (MIL-H-5606) and high temperature lubricating oil (MIL-L-9236) followed by a one-hour dry.
Sweep Vibration, Mated	Mated connectors shall show no circuit interruptions greater than one microsecond during 12 hours vibration to include six sweeps in each axis at extreme temperatures of -85°F [-65°C] and 257°F [+125°C] per MIL-STD-202, Method 204, Test Condition D. Post inspection shall show no detrimental cracking, breaking, or loosening of parts.
Moisture Resistance	The insulation resistance of mated connectors shall exceed 1000 megohms after subjection to moisture resistance testing per MIL-STD-202, Method 106, as amended by MIL-C-38300.
Altitude Breathing	The insulation resistance of wired and mated connectors shall be 5000 megohms, minimum, and there shall be no flashover or breakdown at test voltage of 1000 volts RMS after the third cycle and while immersed in 5% salt water solution at 68°F [20°C] and room ambient pressure at 68°F [20°C].
Salt Spray	Unmated plugs and receptacles shall show no excessive corrosion which would detrimentally affect the electrical and mechanical performance of the connectors after subjection to 24 hours exposure to salt spray atmosphere per MIL-STD-202, Method 101.

MARC 63 Series Connectors (Continued)

Part Number and Ordering Information

Connector part numbers indicate size, shape, insert layout, type of seal, style of contact and polarization.

Note: Pin or socket (power or coaxial) contacts may be used in either plugs or receptacles. However, it is recommended that pins be placed in the receptacle when possible to take advantage of our "scuff-proof" design.

Typical Part Number

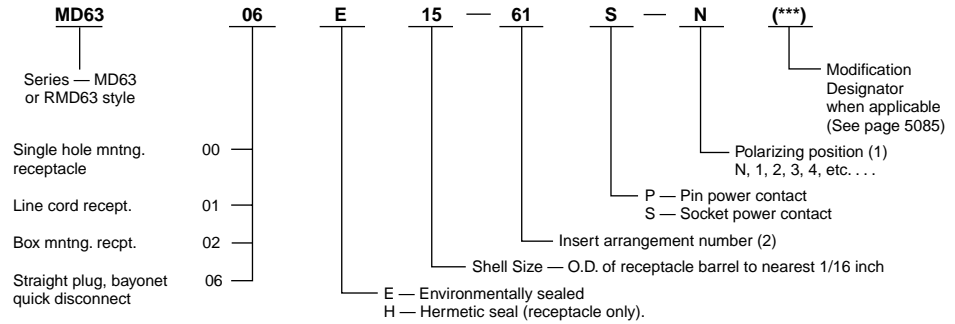

- (1) For polarizing key positions see MARC 53 Series Connectors.
 - (2) For contact arrangements see MARC 53 Series Connectors.
- Note:** If P or S does not appear in the numbering system, no contacts will be supplied with order (order separately).

Configurations

MD63-06E/RMD63-06E

Straight Plug, Bayonet Coupling, Environmental and Non-Environmental (Mates with Receptacles 02, 00 and 01)

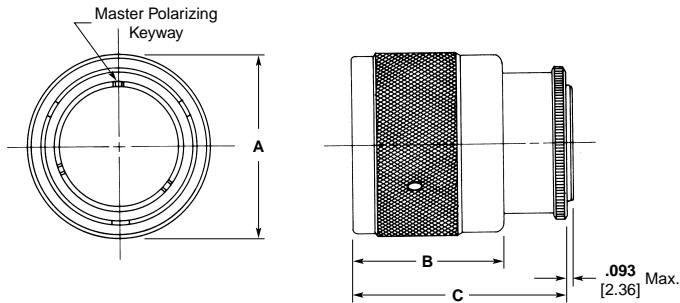

Shell Size	Dimensions		
	A	B (Max.)	C (Max.)
9	.813 20.65	1.000 25.4	1.288 32.72
12	1.000 25.40	1.000 25.4	1.288 32.72
15	1.125 28.58	1.000 25.4	1.288 32.72
18	1.594 40.49	1.000 25.4	1.288 32.72

MARC 63 Series Connectors (Continued)

Configurations (Continued)

MD63-02E/RMD63-02E

Receptacle, Box Mounting, Environmental and Non-Environmental (Mates with Plug, Type 06)

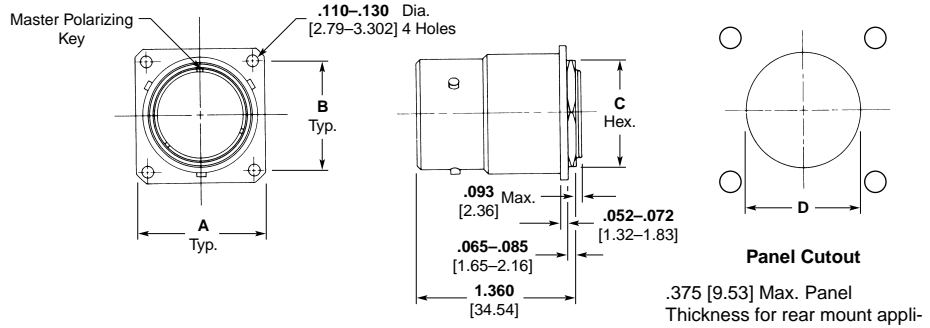

Shell Size	Dimensions			
	A	B	C	D
9	.875 22.23	.662 16.81	.562 14.27	.693-.697 17.60-17.70
12	1.000 25.40	.786 19.96	.75 19.05	.881-.885 22.38-22.48
15	1.125 28.58	.906 23.01	.875 22.23	1.006-1.011 25.55-25.68
18	1.344 34.14	1.062 26.97	1.125 28.58	1.250-1.260 30.48-32.00

MD63-00E/RMD63-00E

Receptacle, Single Hole Mounting, Environmental and Non-Environmental (Mates with Plug, Type 06)

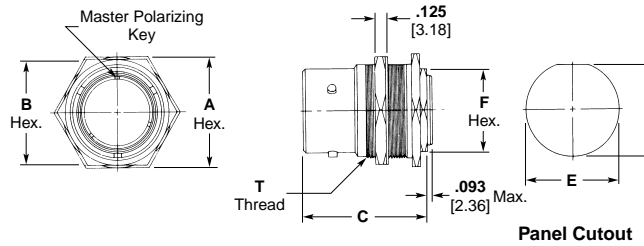

Shell Size	Dimensions						
	A	B	C	D	E	F	T (Class 2A)
9	.813 20.65	.75 19.05	1.360 34.54	.669-.673 16.99-17.09	.693-.697 17.60-17.70	.562 14.27	11/16-32UN
12	1.000 25.40	.937 23.80	1.360 34.54	.850-.856 21.59-21.74	.881-.885 22.38-22.48	.75 19.05	7/8-28UN
15	1.125 28.58	1.062 26.97	1.360 34.54	.975-.979 24.76-24.87	1.006-1.010 25.55-25.65	.875 22.23	1-28UN
18	1.625 41.28	1.375 34.93	1.360 34.54	1.212-1.216 30.78-30.88	1.251-1.255 31.78-31.88	1.125 28.58	1-1/4-28UN

MD63-01E/RMD63-01E

Receptacle, Line Cord, Environmental (Mates with Plug, Type 06)

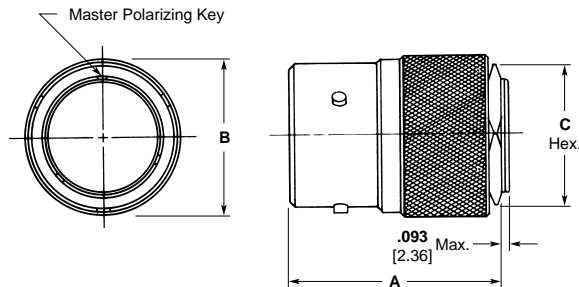

Shell Size	Dimensions		
	A	B (Max.)	C
9	1.360 34.54	.703 17.86	.562 14.27
12	1.360 34.54	.891 22.63	.75 19.05
15	1.360 34.54	1.016 25.81	.875 22.23
18	1.360 34.54	1.203 30.56	1.125 28.58

Accessories
Cable Clamps

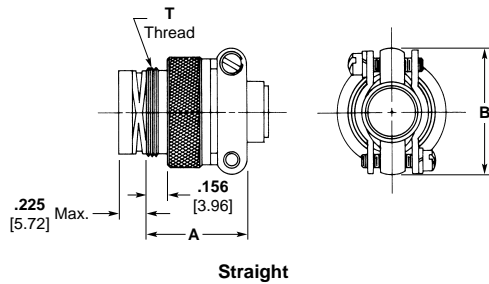

Shell Size	Part No.	A	B	T Thread
9	086-0175-00N1	.704 17.88	.750 19.05	1/2-20UNF-2A
12	086-0176-00N1	.773 19.63	.932 23.67	11/16-24UNEF-2A
15	086-0177-00N1	.829 21.06	1.078 27.38	13/16-20UNEF-2A
18	086-0178-00N1	.890 22.61	1.250 31.75	1-28UN-2A

Straight

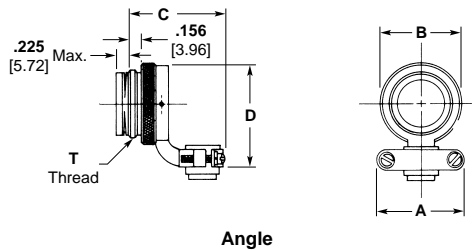

Angle

Shell Size	Part No.	A	B (Max.)	C (Max.)	D	T Thread
9	086-0179-00N1	.737 18.72	.600 15.24	1.100 27.94	.879 22.32	1/2-20UNF-2A
12	086-0180-00N1	.913 23.19	.785 19.94	1.250 31.75	1.067 27.10	11/16-24UNEF-2A
15	086-0181-00N1	1.048 26.62	.962 24.43	1.469 37.31	1.233 31.21	13/16-20UNEF-2A
18	086-0182-00N1	1.225 31.12	1.185 30.10	1.550 39.37	1.550 39.37	1-28UN-2A

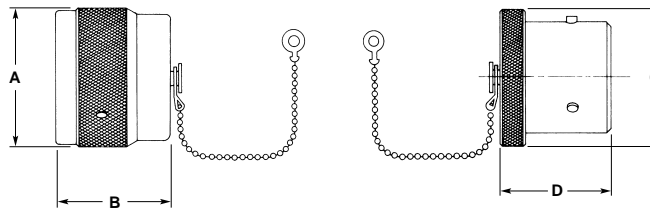

Protective Covers

Shell Size	Receptacle Part No.		Plug Part No.		Dimensions			
	Without Chain	With Chain	Without Chain	With Chain	A	B	C	D
9	086-0253-00P2	086-0257-00L6	086-0261-00F5	086-0265-00L6	.813 20.65	.950 24.13	.813 20.65	.913 23.19
12	086-0254-00P2	086-0258-00L6	086-0262-00F5	086-0266-00L6	1.000 25.40	.950 24.13	1.000 25.40	.913 23.19
15	086-0255-00P2	086-0259-00L6	086-0263-00F5	086-0267-00L6	1.125 28.58	.950 24.13	1.125 28.58	.913 23.19
18	086-0256-00P2	086-0260-00L6	086-0264-00F5	086-0268-00L6	1.594 40.49	.950 24.13	1.594 40.49	.913 23.19

Plastic Protective Covers also available; consult Tyco Electronics.

Modifications

We offer a unique modification system which provides alteration of standard MARC 63 Series Connectors to include special finishes, accessories, and custom

quality assurance provisions — processing, testing, serialization, traceability. Consult your sales representative or Tyco Electronics for additional modification information.

Standard modifications include:

(801): MARC 63 Series Connector, electroless nickel finish

(803): MARC 63 Series Connector including cable clamp, straight type

(804): MARC 63 Series Connector including cable clamp, right-angle type

Contacts for MARC 43, MARC 53 and MARC 63 Connectors

MARC 43, MD53, MD63 Series

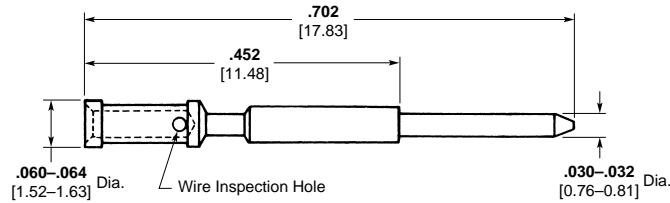

Part Number 083-0009-00R4
22 AWG Pin

MARC RMD53, RMD63 Series

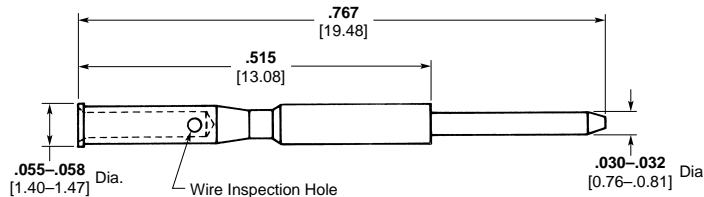

Part Number 083-1200-00R4
22 AWG Pin

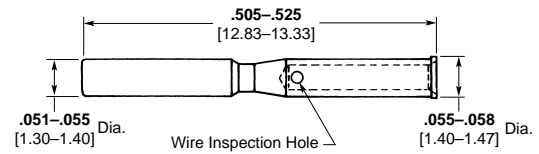

Part Number 082-0461-00Y9
22 AWG Socket

MARC 43, MD53, MD63 Series

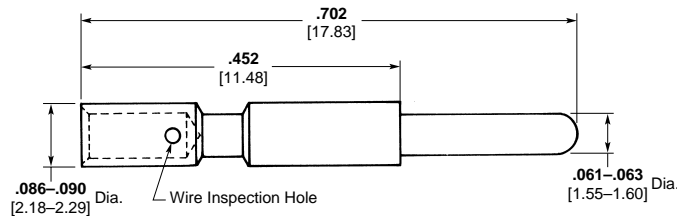

Part Number 083-0158-00R4
16 AWG Pin

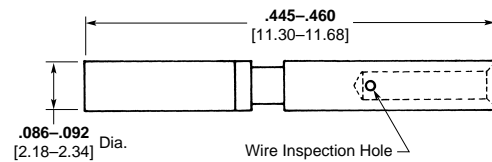

Part Number 082-0113-00T1
16 AWG Socket

MARC 43 Series

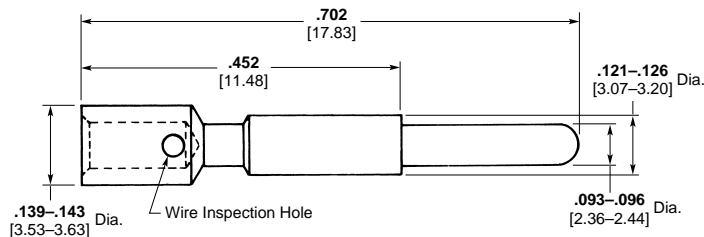

Part Number 083-0173-00R4
12 AWG Pin

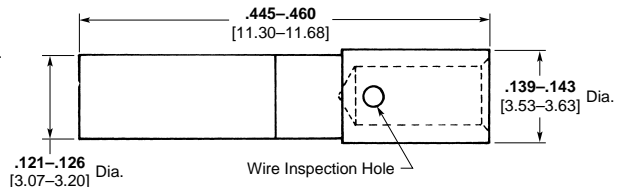

Part Number 082-0132-00T1
12 AWG Socket

MARC MD53, MD63 Series

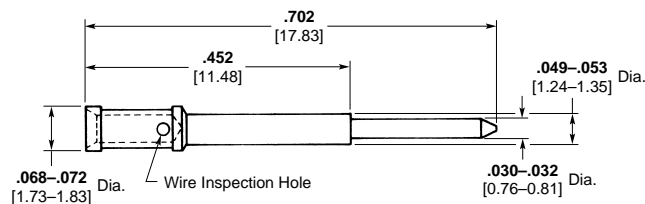

Part Number 083-1435-00R4
22-20 AWG Pin

Contacts for MARC 43, MARC 53 and MARC 63 Connectors (Continued)

MARC 43, MD53, MD63 Series

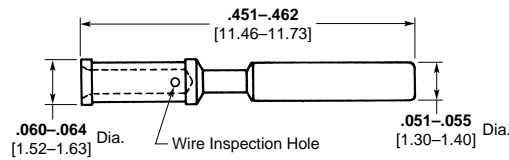

Part Number 082-0464-00Y9
22 AWG Socket

MARC MD53, MD63 Series

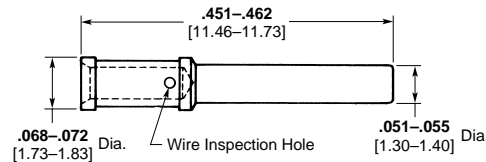

Part Number 082-0466-00Y9
22-20 AWG Socket

Coaxial Contacts

MARC 43, MD53, MD63 Series

Solder Type Coaxial Contacts

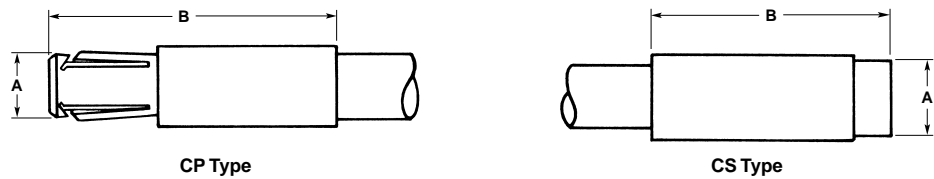

Contact	Part No.	Type	A Dia.	B
50 Ω	084-0027-00T2	CS	.109 2.77	.452 11.48
	084-0024-00T2	CP	.093 2.36	.600 15.24
75 Ω	084-0028-00T2	CS	.123 3.12	.452 11.48
	084-0025-00T2	CP	.106 2.69	.600 15.24
95 Ω	084-0029-00T2	CS	.168 4.27	.452 11.48
	084-0026-00T2	CP	.149 3.78	.600 15.24

MARC 43 Series

LEPRA/CON Crimp Type,
50 Ohm Coaxial Contacts

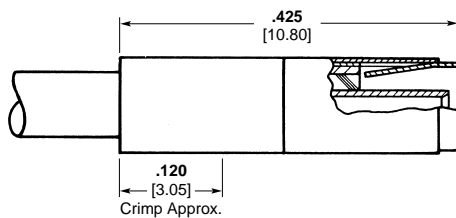

Part Number 142-1500-0001
CS Socket

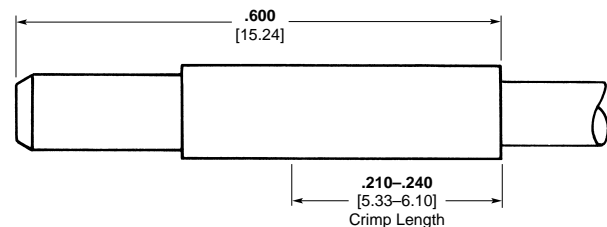

Part Number 141-1500-0001
CP Pin

Size	Part No.	Application	Description
	086-0001-0000	Unsealed 43 Series	
22 AWG	086-0009-0000	Sealed 43 Series MD53, RMD53 MD63, RMD63	
	086-0148-0000	RMD53, RMD63	
	086-0056-0000	Sealed 43 Series MD53, MD63	
16 AWG	086-0010-0000	Sealed 43 Series MD53, MD63	
	086-0014-0000	Unsealed 43 Series	
	086-0057-0000	Sealed 43 Series	
12 AWG	086-0015-0000	Unsealed 43 Series	
22/20 AWG	086-0251-0000	MD53, MD63	

Size	Part No.	Application	A Dia.	B Dia.	Description
5052	086-0061-0000	Unsealed 43 Series	.112-.120 2.84-3.05	—	
7552	086-0062-0000		.135-.143 3.43-3.63	—	
9552	086-0063-0000		.178-.186 4.52-4.72	—	
5052	086-0058-0000	Sealed 43 Series	.081-.089 2.06-2.26	.112-.120 2.84-3.05	
7552	086-0059-0000		.106-.114 2.69-2.90	.135-.143 3.43-3.63	
9552	086-0060-0000		.151-.159 3.84-4.04	.178-.186 4.52-4.72	

Assembly Tools

MARC 43, 53 and 63 Series Connectors

Removal Tool — None required.
Crimp Tools — Turret style tool (M22520/1-01 and TH88) MICRODOT Part Number 010-0080-0000 — Crimps all power contacts.
Locator Style Tool — MICRODOT Part Number 010-0070-0000 with locators.

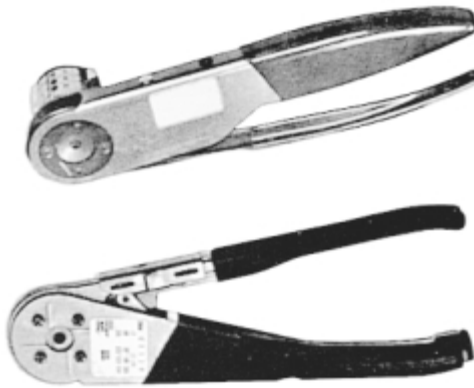

Contact Size	Wire Size	Locator
22	22, 24	010-0072-0000
22	26	010-0087-0000
16	16, 18	010-0075-0000

For MARC 43 Series Connector Crimp Coax Contacts Use 010-0132-0000 & 010-0169-0000.

MARC 73 Series Connectors

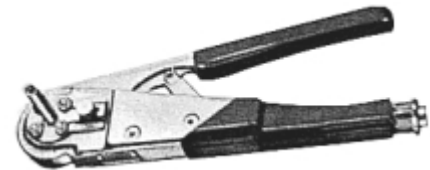
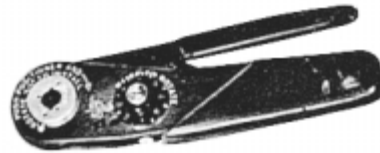

Description	Part No.
Crimp Tool w/ Locator	010-3008-0000
Crimp Tool Only	010-3009-0000 M22520/2-01
Locator Only	010-3010-0000

Description	Part No.
Crimp Tool w/ Locator	010-3002-0000
Crimp Tool Only	010-0190-0000
Locator Only	010-3007-0000

Service and Performance Data

MARC 73 Series Connectors meet or exceed the performance requirements of specification MIL-C-38999. Your sales representative or field engineer can supply detailed, cross-reference information. MARC 73 Series Connectors meet the following selected test parameters as specified below:

DESCRIPTION	TEST REQUIREMENTS
Contact Retention	Contacts are to withstand 10 lbs [44.48 N] axial load without axial displacement in excess of 0.012 [0.30] or damage to contacts or inserts when the axial load is applied to the mating end of the contacts in unmated plugs and receptacles at a rate of approximately 1 lb/sec. [4.45 N].
Contact Resistance	The potential drop across normally mated contacts shall not exceed 25 mv under room ambient and high temperature service conditions when measured as specified in MIL C-39029 with maximum rated current.
Dielectric Withstanding Voltage, Altitude and Sea Level	No evidence of dielectric breakdown or flashover when mated and unmated plugs are subjected to 645 and 180 volts RMS, respectively, at altitudes up to 70,000 feet [21,336 m] and 1000 volts RMS at sea level.
Insulation Resistance, Room and High Temp.	Insulation resistance of mated plugs and receptacles shall be 5000 megohms, minimum, at room temperature and 1000 megohms, minimum, at 257°F [+125°C] when measured per MIL-STD 202, Method 302, Test Condition B.
Coupling and Uncoupling	Plugs and receptacles shall withstand up to 500 cycles of engagement and separation without detrimental damage to plugs or receptacles or not satisfying subsequent tests.
Fluid Immersion	Mating and unmating forces shall not exceed 27 lbs [120.10 N] maximum, (15 shell size) after fully wired plugs and receptacles are immersed for 20 hours, each, in hydraulic fluid (MIL-H-5606) and high temperature lubricating oil (MIL-L-9236) followed by a one-hour dry.
Sweep Vibration, Mated	Mated connectors shall show no circuit interruptions greater than one microsecond during 12 hours vibration to include six sweeps in each axis at extreme temperatures of -85°F [-65°C] and 257°F [+125°C] per MIL-STD-202, Method 204, Test Condition D. Post inspection shall show no detrimental cracking, breaking, or loosening of parts.
Moisture Resistance	The insulation resistance of mated connectors shall exceed 1000 megohms after subjection to moisture resistance testing per MIL-STD-202, Method 106.
Altitude Breathing	The insulation resistance of wired and mated connectors shall be 5000 megohms, minimum, and there shall be no flashover or breakdown at test voltage of 1000 volts RMS after the third cycle and while immersed in 5% salt water solution at 68°F [20°C] and room ambient pressure at 68°F [20°C].
Salt Spray	Unmated plugs and receptacles shall show no excessive corrosion which would detrimentally affect the electrical and mechanical performance of the connectors after subjection to 24 hours exposure to salt spray atmosphere per MIL-STD-202, Method 101.

Service and Performance Data

I. Electrical — Electrical Ratings

Contact Size	Current Rating (Amperes, Max., 81°F [+27°C])	Dielectric Withstanding Voltage (RMS)	Working Voltage		Contact Resistance (Millivolts, Max.)
			Sea Level	110,000 Ft. Alt. ¹	
22 AWG	5	1000	750	300	8

¹ 110,000 ft = 33,528 m

Wire Range Accommodations

Wire Barrel Size	Wire Size	O.D. of Finished Wire Range	Nominal	Wire Spec. MIL-W-16878
22 AWG	26	.029 Min. 0.74	.031 Nom. 0.79	Type "E" or "ET"
	24	—	.036 Nom. 0.91	Type "ET"
	22	.044 Max. 1.12	.042 Nom. 1.07	Type "ET"

II. Mechanical — Durability: 500 Cycles Mate/Unmate. Coupling/Uncoupling Forces and Tightening Torques:

Shell Size	Coupling/Uncoupling Force (In-Lbs.) Max.	Tightening Torque (In-Lbs.)	
		Retaining Nut	Mounting Nut
9	10 [44.48]	20 [2.26 N] Max.	30-45 [3.39 Nm – 5.08 Nm]
12	15 [66.72]	20 [2.26 N] Max.	40-55 [4.52 Nm – 6.21 Nm]
15	22 [97.86]	20 [2.26 N] Max.	55-70 [6.21 Nm – 7.91 Nm]
18	28 [124.55]	20 [2.26 N] Max.	70-85 [7.91 Nm – 9.60 Nm]

Operating Temperature: -67°F to 257°F [-55°C to +125°C]. Connector Mated Length: 2.217 [56.31] Max.

Part Number and Ordering Information

MARC 73 Series Connector part numbers indicate size, shape, insert layout, type of seal, style of contact and polarization.

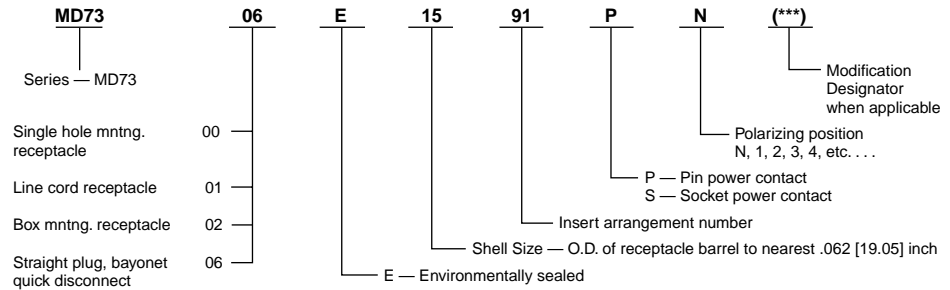

Notes: Pin contacts in plug; socket contacts in receptacle. If P or S does not appear in the numbering system, no contacts will be supplied with order (order separately).

Contact Arrangements¹

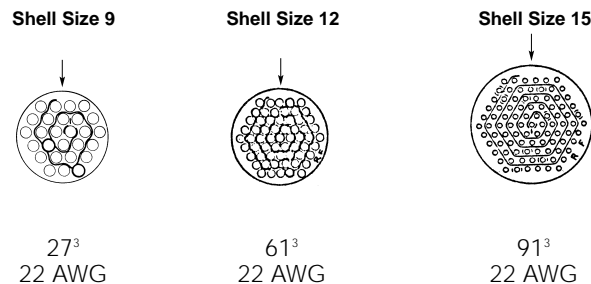

Insert Arrangement²
Number of Contacts
Contact Size

¹ Views shown are front face views of receptacles. Front face view of plug is mirror image of that shown.
² Arrow (↓) indicates insert top or vertical position in relation to top or vertical position of housing.
³ The 22 AWG contact arrangements will accommodate MIL-W-16878 Type ET, 22, 24, 26 AWG wire. Contact spacing is on 0.065 [1.65] centers.

MARC 73 Series Connectors (Continued)

Configurations

MD73-06E

Straight Plug, Bayonet Coupling, Environmental and Non-Environmental (Mates with Receptacles 02, 00 and 01)

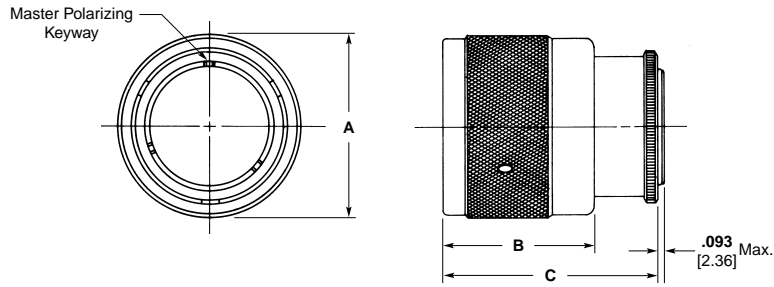

Shell Size	Dimensions		
	A	B (Max.)	C (Max.)
9	.813 20.65	1.000 25.40	1.288 32.72
12	1.000 25.40	1.000 25.40	1.288 32.72
15	1.125 28.58	1.000 25.40	1.288 32.72
18	1.594 40.49	1.000 25.40	1.288 32.72

MD73-02E

Receptacle, Box Mounting, Environmental and Non-Environmental (Mates with Plug, Type 06)

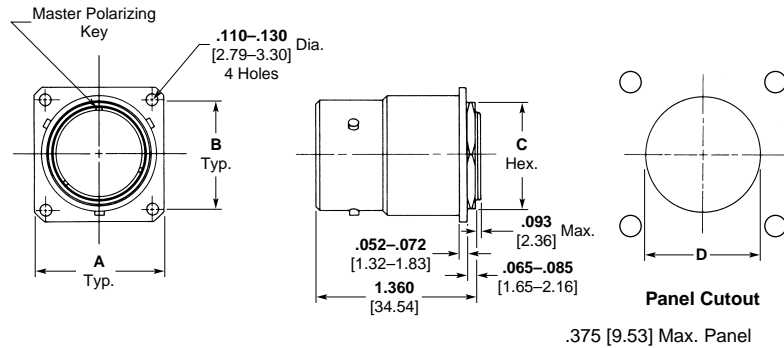

Shell Size	Dimensions			
	A	B	C	D
9	.875 22.23	.662 16.81	.562 14.27	.693-.697 17.60-17.70
12	1.000 25.40	.786 19.96	.75 19.05	.881-.885 22.38-22.48
15	1.125 28.58	.906 23.01	.875 22.23	1.006-1.011 25.55-25.68
18	1.344 34.14	1.062 26.97	1.125 28.58	1.250-1.260 31.75-32.00

MD73-00E

Receptacle, Single Hole Mounting, Environmental and Non-Environmental (Mates with Plug, Type 06)

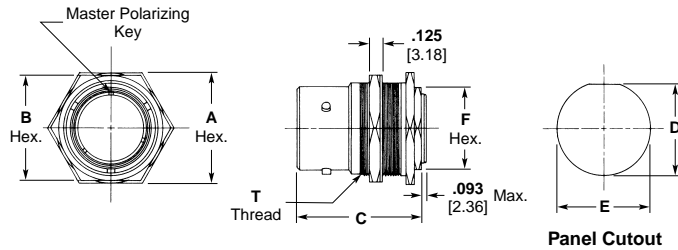

Shell Size	Dimensions						
	A	B	C	D	E	F	T (Class 2A)
9	.813 20.65	.75 19.05	1.360 34.54	.669-.673 16.99-17.09	.693-.697 17.60-17.70	.562 14.27	11/16-32UN
12	1.000 25.40	.937 23.80	1.360 34.54	.850-.856 21.59-21.74	.881-.885 22.38-22.48	.75 19.05	7/8-28UN
15	1.125 28.58	1.062 26.97	1.360 34.54	.975-.979 24.77-24.87	1.006-1.010 25.55-25.65	.875 22.23	1-28UN
18	1.625 41.28	1.375 34.93	1.360 34.54	1.212-1.216 30.78-30.89	1.251-1.255 31.78-31.88	1.125 28.58	1-1/4-28UN

MARC 73 Series Connectors (Continued)

Configurations (Continued)

MD73-01E

Receptacle, Line Cord,
Environmental (Mates with
Plug, Type 06)

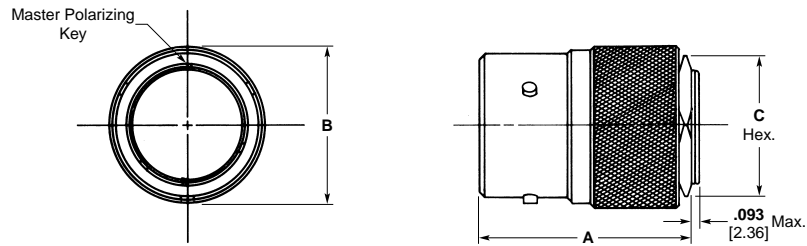

Shell Size	Dimensions		
	A	B (Max.)	C
9	1.360	.703	.562
	34.54	17.86	14.27
12	1.360	.891	.75
	34.54	20.57	19.05
15	1.360	1.016	.875
	34.54	25.81	22.23
18	1.360	1.203	1.125
	34.54	30.56	28.58

Accessories
Cable Clamps

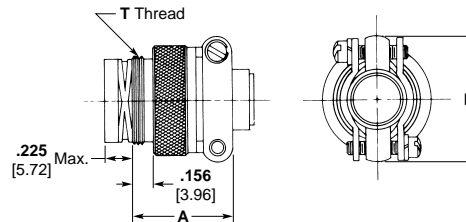

Shell Size	Clamp Part No.	A	B	T Thd. 2A
9	086-0341-00N1	.704 17.88	.750 19.05	1/2-20 UNF
12	086-0342-00N1	.773 19.63	.932 23.67	11/16-24 UNEF
15	086-0343-00N1	.829 21.06	1.078 27.38	13/16-20 UNEF
18	086-0344-00N1	.890 22.61	1.250 31.75	1-28 UN

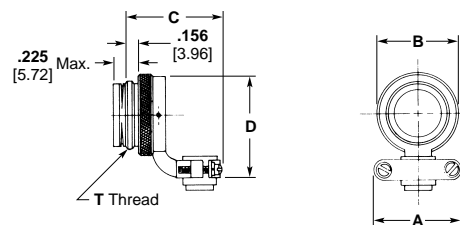

Shell Size	Clamp Part No.	A	B (Max.)	C (Max.)	D	T Thd. 2A
9	086-0337-00N1	.737 18.72	.600 15.24	1.100 27.94	.879 22.33	1/2-20 UNF
12	086-0338-00N1	.913 23.19	.785 19.94	1.250 31.75	1.067 27.10	11/16-24 UNEF
15	086-0339-00N1	1.048 26.62	.962 24.43	1.469 37.31	1.233 31.32	13/16-20 UNEF
18	086-0340-00N1	1.225 31.12	1.185 30.10	1.550 39.37	1.550 39.37	1-28 UN

Accessories (Continued)

Contacts

Twist pin — 22 Pins and Sockets

Copper alloy plated .000050 [0.00127]
gold over copper flash per MIL-G-45204,
Type II

Rating — 5 amps

Contact Resistance — .008 ohms
max.

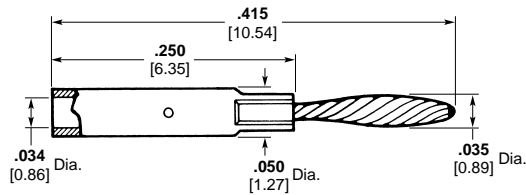

Part Number 096-0526-0000

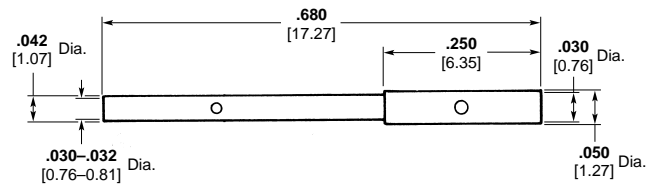

Part Number 096-0626-0001

Engineering/Separation Forces —
6 oz. [1.67 N] max. / .502 [1.139 N] min.

Durability — 2000 cycles

Contact Cavity Sealing Plugs

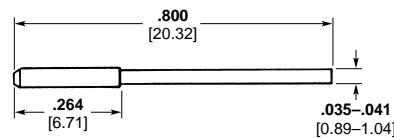

Part Number 086-0331-0000

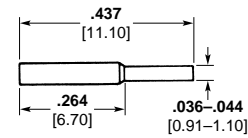

Part Number 086-0330-0000

Contact Size	Sealing Plug	Filler Plug
22 AWG	086-0331-0000	086-0330-0000

Note: Sealing plug occupies insert and grommet cavities.
Filler plug occupies insert cavity only.

MQR Series — Microminiature Circular Connectors



MQR stands for MICRODOT Quick Release. This line of circular quick disconnect connectors has metal shells with push-pull couplings which provide a positive connection for rugged environmental use. The MQR series is specified for cable-to-cable and cable-to-panel applications.

The plug connector side contains socket contacts. The receptacle connector side contains pin contacts. Because the pin contact is

“active” or “live”, the pins require the physical protection that the receptacle side offers. (Similar to a “protected” or “shrouded” header.)

While there is no optional hardware for the MQR series, the receptacles incorporate a standard jam nut to tighten the connector down to the board or panel.

MQR connectors are manufactured to the performance specifications of MIL-PRF-83513.

How to Specify/ Ordering Code

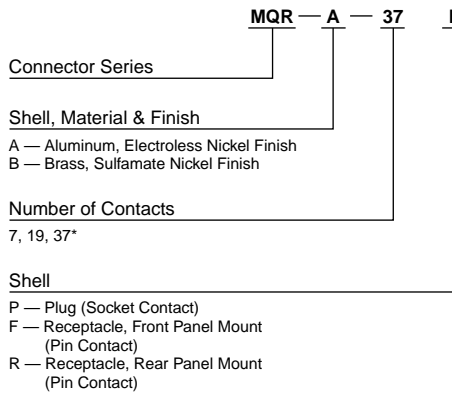

* uses twist pin contact

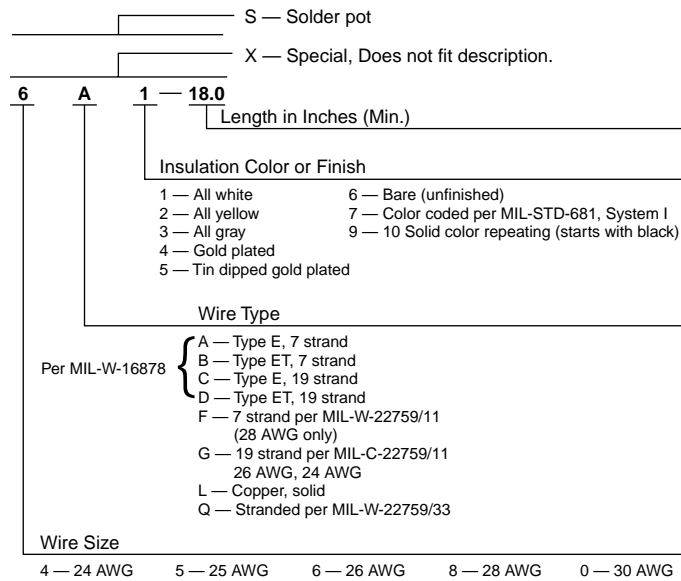

5 Pin and Socket Connectors

MQR Plug

Size	Dimensions	
	Ø A	Ø B
7	.375 9.53	.300 7.62
19	.475 12.07	.400 10.16
37	.750 19.05	.630 16.00

Front Panel Mount (MQR Receptacle)

Size	Dimensions			
	A (Hex)	B (Min.)	Ø C (Min.)	D Thd.
7	.500 12.7	.361 9.17	.376 9.55	3/8-32 UNEF-2A
19	.625 15.88	.477 12.16	.501 12.73	1/2-28 UNEF-2A
37	.812 20.62	.722 18.39	.751 19.07	3/4-20 UNEF-2A

MQR Series — Microminiature Circular Connectors (Continued)

Rear Panel Mount (MQR Receptacle)

Size	Dimensions			
	A (Hex)	B (Min.)	Ø C (Min.)	D Thd.
7	.500 12.7	.422 10.72	.440 11.18	7/16-28 UNEF-2A
19	.687 17.45	.531 13.49	.564 14.33	9/16-24 UNEF-2A
37	.812 20.62	.722 18.39	.751 19.07	3/4-20 UNEF-2A

Circular MQR Series Quick Release Plug

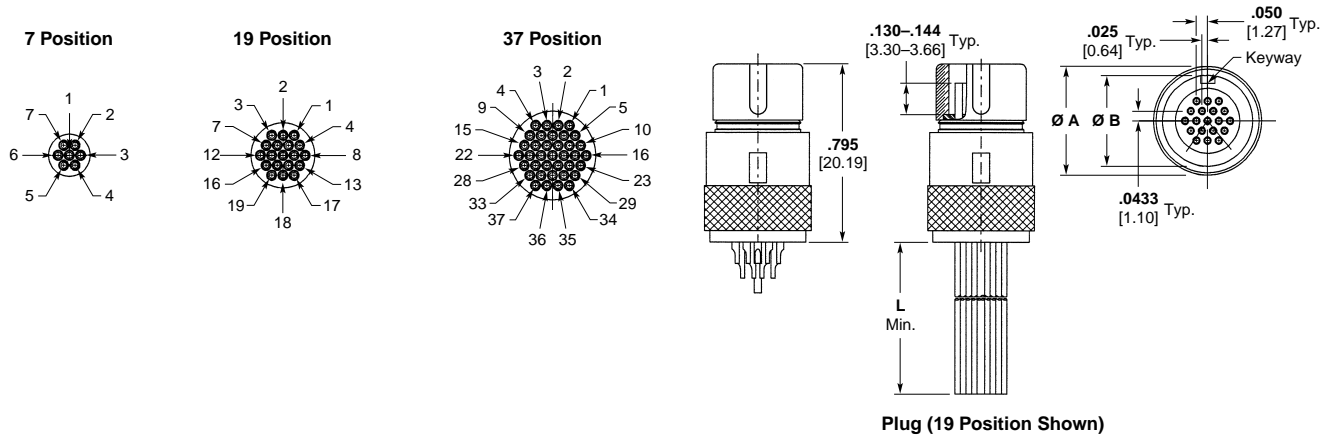

Circular MQR Series Quick Release Receptacle

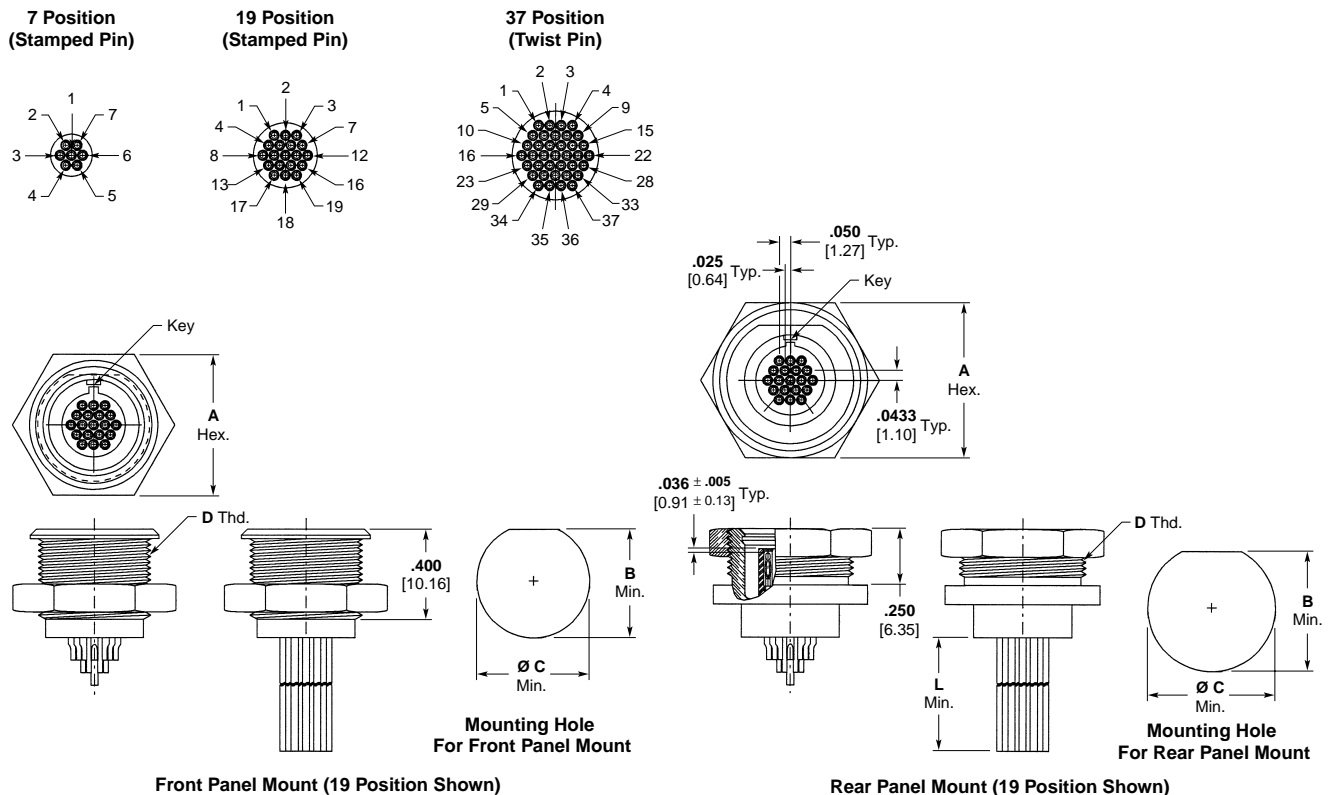

MTC Series — Microminiature Circular Connectors

How to Specify/
Ordering Code

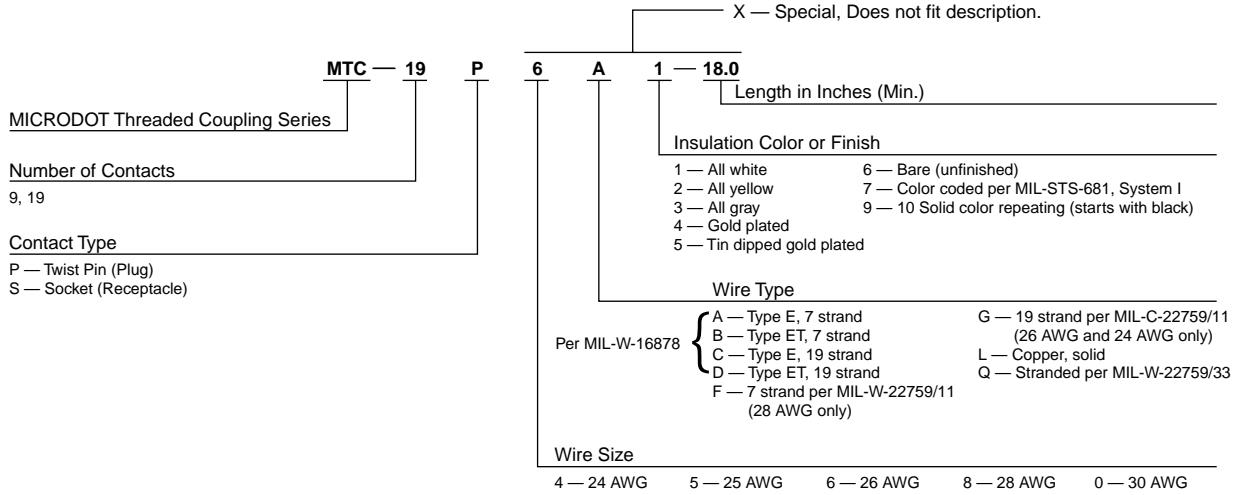

Material and Finish

Shell — Aluminum, nickel plated
Contact — Copper alloy, gold plated
Insulator — RYTON

MTC Series Plug

Size	Dimensions		
	Ø A	Ø B	C Thd.
9	.227	.456	M10 x 0.75
	5.77	11.58	19.05
19	.308	.545	M12 x 1
	7.82	13.84	25.40

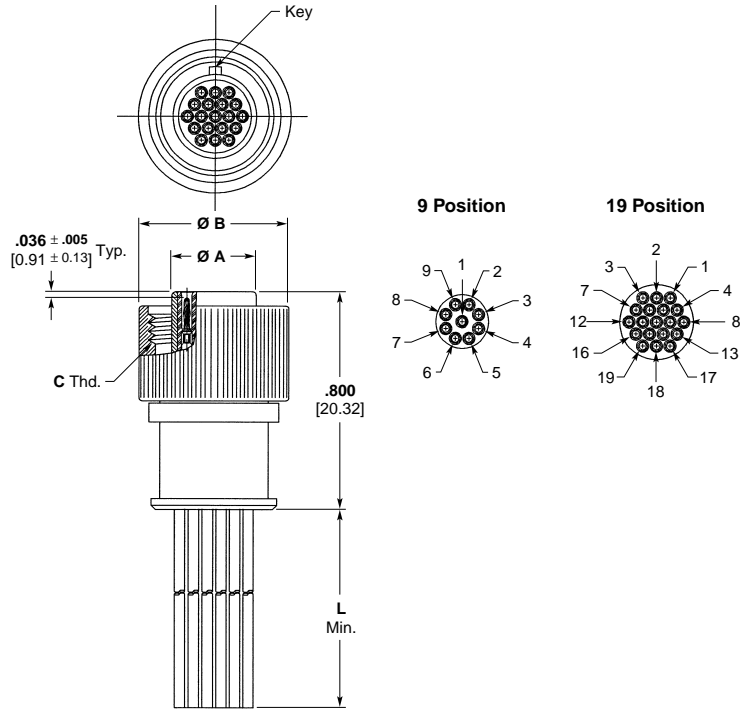

MTC Series Plug (19 Position Shown)

MTC Series — Microminiature Circular Connectors (Continued)

MTC Series Receptacle

Size	Dimensions				
	Ø A	B Hex.	C Thd.	D Min.	Ø E Min.
9	.562 14.27	.500 12.70	M10 x 0.75 19.05	.370 9.40	.394 10.01
19	.625 15.88	.625 15.88	M12 x 1 25.40	.445 11.30	.474 12.04

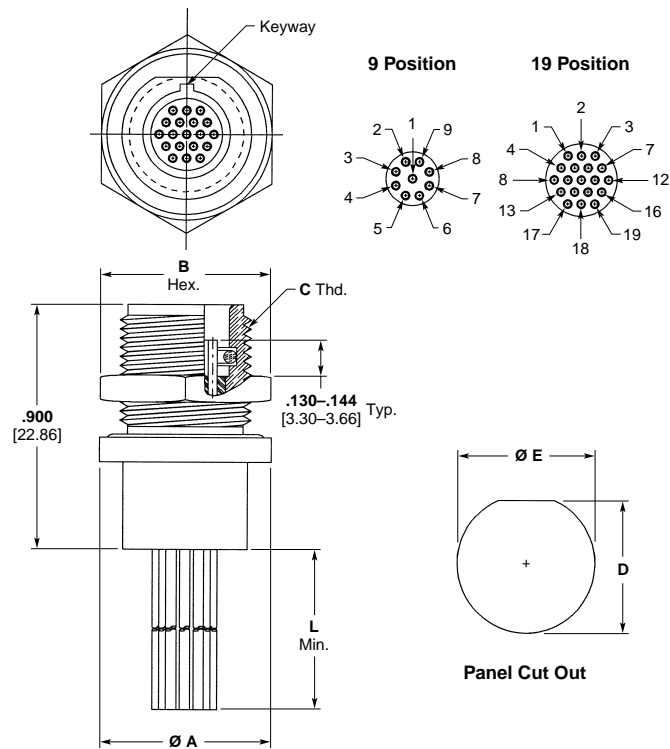

MTC Series Receptacle (19 Position Shown)

Introduction

Product Facts

- Military qualified connectors conform to the latest amendments of MIL-DTL-24308
- Industrial versions available that use the same manufacturing process of MIL-C-24308 connectors
- Non-magnetic versions available per NASA spec, or with rubber grommet on rear of NASA-type connector
- ULTRA-LITE AMPLIMITE non-magnetic connectors save weight and improve EMI shielding vs. brass shell NASA-style connectors
- MIL-C-39029 contacts offer reliability and economies of high speed termination by automatic machine
- Connector savers (feed-through) preserve permanently mounted connectors in high use applications
- Choice of sizes — Size 1 through 5 for Series 109, standard density with 9, 15, 25, 37 and 50 contacts; Size 1 through 6 for Series 90, high density with 15, 26, 44, 62, 78 and 104 contacts
- Series 109 standard density connectors are available with cavities for power or coaxial contacts mixed with size 20 signal contacts
- Right-angle and straight PC board connectors in Series 109, standard density
- Preloaded, straight-posted connectors available in Series 90, high density
- Preloaded, solder cup connectors available in Series 109, standard density
- Produced under a Quality Management System certified to ISO 9001

A copy of the certificate is available upon request

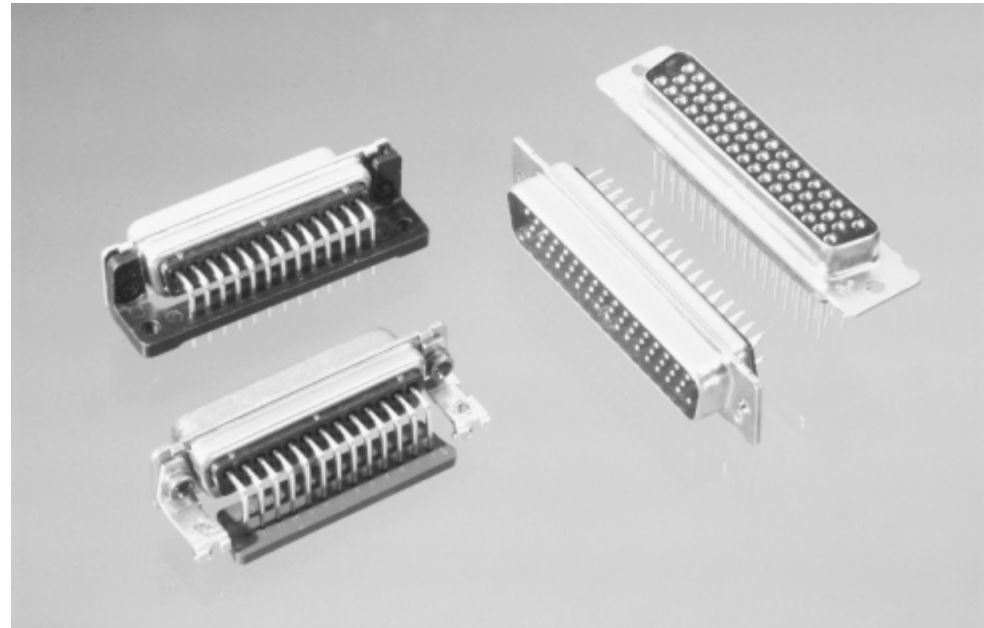

AMPLIMITE Military Subminiature D Connectors are compact pin and socket connectors especially designed for high density packages. They are ideally suited for applications such as military equipment, ground support devices, computer peripheral equipment, modems and industrial instrumentation.

In addition to the complete selection of standard military subminiature D-type connectors, Tyco Electronics offers special application versions such as connectors which mix power/coax cavities with size 20 signal contacts; feed-through connectors which provide a disposable interface for high use applications; and special non-magnetic connectors with a rubber grommet on the rear, for strain relief.

Series 109 and Series 90 military connectors conform

to the latest amendments of the MIL-DTL-24308 specification and thus are intermateable with similar connectors in the same sizes from other manufacturers. A broad range of connectors is included in this catalog, complemented by a variety of commercial cable clamps and mating hardware, which can be found in catalog 1307612.

Each AMPLIMITE crimp connector has metal clips which retain the pins and sockets after they are loaded into the inserts from the rear.

Series 109 connectors accept size 20 contacts, while Series 90 connectors accept size 22 contacts. Cavity spacing conforms to military specifications.

Size 20 and size 22 pins and sockets are designed for an 8-indent crimp. They are supplied loose-piece for

crimping in a standard M22520/2 hand operated tool or tape-mounted for high speed application by an AMP-TAPEMATIC Stripper/Crimper Machine.

Series 90 and Series 109 connectors preloaded with contacts are available for printed circuit board mounting.

Special Series 109 connectors with power/coax cavities accept power contacts for 18 through 8 AWG [0.8-8 mm²] wire or coaxial contacts for RG/U 174, 188A and 316 cable, in combination with standard size 20 signal contacts.

A complete range of non-military AMPLIMITE subminiature D connectors, contacts and accessories are shown in catalog 1307612, available on request from Tyco Electronics.

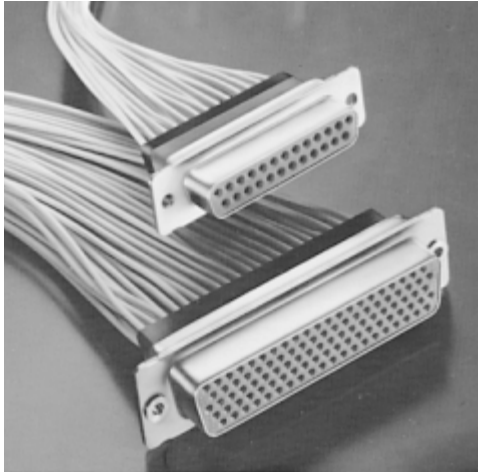

Connectors for crimp, snap-in contacts are available in both series, standard shells and non-magnetic, plus non-magnetic with rear rubber grommet.

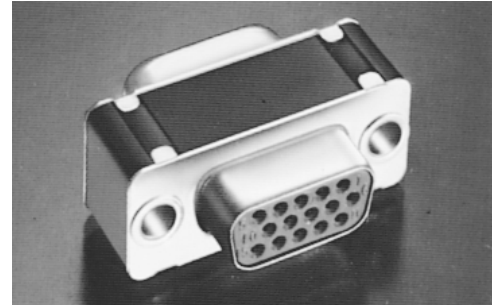

Connector savers extend life in high-use applications.

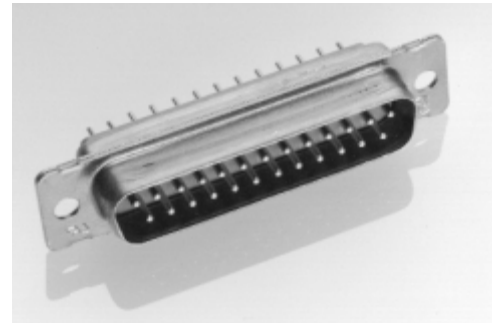

Straight posted versions available in both (Series 109) standard density and (Series 90) high density connectors.



Coax or power contacts can be mixed with signal contacts.

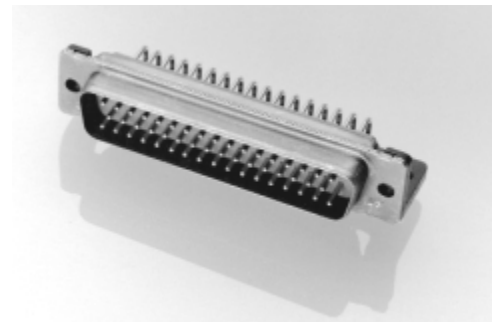

Right-angle board mount connectors for Series 109, standard density connections.

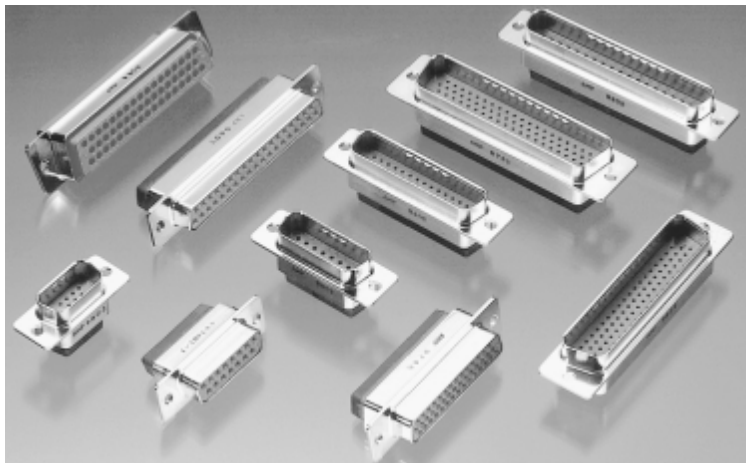

ULTRA-LITE AMPLIMITE Connectors for state-of-the-art weight savings and EMI performance.

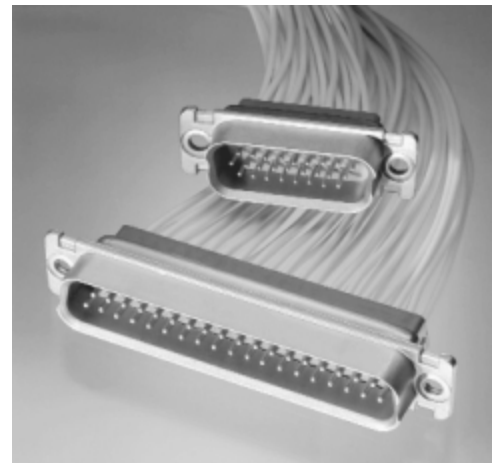

The Series 109 and 90 Blindmate Plug connectors are designed to prevent butting of contacts during mating.

Series 109 Connectors (Standard Density)

Insert Arrangements

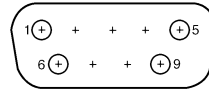

**9 Position
(Shell Size 1)
MS 18273-1**

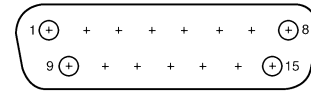

**15 Position
(Shell Size 2)
MS 18274-1**

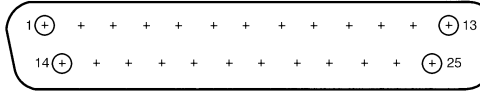

**25 Position
(Shell Size 3)
MS 18275-1**

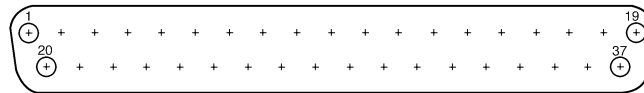

**37 Position
(Shell Size 4)
MS 18276-1**

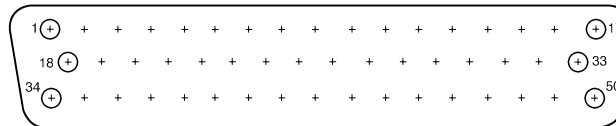

**50 Position
(Shell Size 5)
MS 18277-1**

Note: Mating face of plug shown; receptacle is mirror image.

Performance Specifications

All Series 109 AMPLIMITE military connectors conform to the latest amendments of military specification MIL-DTL-24308. For more detailed information refer to MIL-DTL-24308.

All Series 109 Connectors are designed for a -67°F to 257°F [-55°C to +125°C] temperature range.

Series 109 contact current rating for Crimp Snap Connectors for MIL-C-39029 7.5 amps in free air.

Series 109 contact current rating for PCB Mount Connectors 5.0 amps per 108-1770.

Technical Documents List

The following technical documents cover the application and performance of AMPLIMITE Series 109 Connectors, contacts, tooling and accessories.

Military Specifications

MIL-DTL-24308 Connectors, Electric, Rectangular, Miniature Polarized Shell, Rack and Panel, General Specifications for

MIL-C-39029 Contacts, Electrical Connector, General Specification for

NASA Specification

GSFC-S-311-P-4 Non-Magnetic Connectors, General Specification for

AMP Instruction Sheets

- 408-7516 AMP Application Tooling for MIL-C-39029 Contacts
- 408-7634 Application and Maintenance for AMP Hand Crimping Tool 90302-1
- 408-7694-1 Application and Maintenance for AMP Hand Crimping Tool 90312-1
- 408-7954 Application and Maintenance for AMP Hand Crimping Tool 90374-1
- 408-7508 AMP Insertion/Extraction Tools 91067-1, 91067-2 and 91067-3
- 408-7837 AMP Female Screwlock Kit 205817-1 and AMP Male Screw/Retainer Kit 211883-5

Size 20 Crimp Contacts for Series 109 Connectors (MIL-C-39029)

Size 20 Crimp, Snap-In Contacts .040 [1.02] Pin Diameter

Material and Finish:

Pin and Socket Body —

^aContact Body & Mating Area — Copper alloy, plated gold .000050–.000100 [0.00127–0.00254] thick over .000050–.000100 [0.00127–0.00254] thick nickel underplate.

^bContact Body — Copper alloy, gold flash .000005 [0.00013] min thick over .000050–.000100 [0.00127–0.00254] thick nickel underplate.

^cMating Area — Copper alloy, plated gold .000050 min thick over .000050–.000100 [0.00127–0.00254] thick nickel underplate.

Socket Hood — Passivated stainless steel.

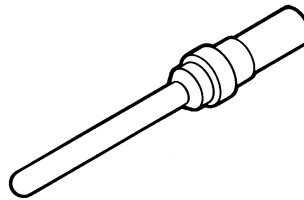

Pin
M39029/64-369
(Supersedes M24308/11-1)

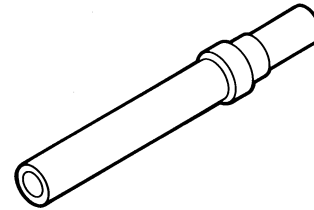

Socket
M39029/63-368
(Supersedes M24308/10-1)

Wire Size Range AWG [mm ²]	Ins. Dia. (Max.)	Contact Configuration	Tape Mounted Contacts Part No.	Loose Piece Contacts		Hand Tool		Contact Color Band
				Military Part No. (M39029/)	AMP Part No.	Tool No. (M22520/)	Positioner No. (M22520/)	
20-24 0.6-0.2	.072 1.83	Pin	205089-2 ^a	64-369	205089-1 ^a	02-01	02-08	orange, blue, white
		Socket	205090-2 ^a	63-368	205090-1 ^a	02-01	02-08	orange, blue, gray
20-24 0.6-0.2	.072 1.83	Pin	1218371-2 ^b	64-369	1218371-1 ^b	02-01	02-08	orange, blue, white
		Socket	1218372-2 ^b	63-368	1218372-1 ^b	02-01	02-08	orange, blue, gray

Tape mounted contacts are used in the AMP-TAPEMATIC Stripper/Crimper Machine Part Number 599406-7 (page 5142).

- Notes:** 1. These contacts are used in Series 109 military connectors.
 2. Insertion/Extraction Tool Part Number 91067-2 (Military Part Number M81969/1-02) is used to install and remove pin and socket contacts.
 3. See AMP Instruction Sheet 408-7516 for wire length, tool and selector settings.
 4. Color bands are read in the direction of terminal (wire barrel) end to mating end.

Size 20 Crimp Contacts for Series 109 Connectors (Industrial Grade)

Size 20 Crimp, Snap-In Contacts .040 [1.02] Pin Diameter

Material and Finish:

Pin and Socket Body —

Pin Body — Brass, plated gold .000030 [0.00076] min thick over .000050–.000150 [0.00127–0.00381] thick nickel underplate.

Socket Body — Brass, plated gold .000010 [0.00025] min thick over .000050–.000150 [0.00127–0.00381] thick nickel underplate.

Socket Clip — Copper alloy, plated gold .000050 [0.00013] min thick over .000050–.000150 [0.00127–0.00381] thick nickel underplate.

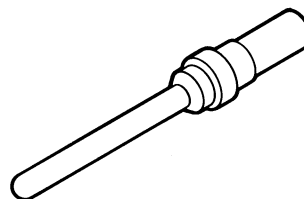

Pin

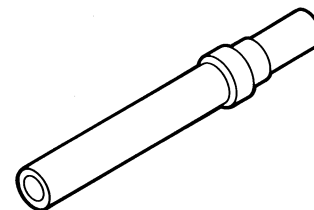

Socket

Wire Size Range AWG [mm ²]	Ins. Dia. (Max.)	Contact Configuration	Tape Mounted Contacts Part No.	Loose Piece Contacts Part No.	Hand Tool	
					Tool No. (M22520/)	Positioner No. (M22520/)
20-24 0.6-0.2	.072 1.83	Pin	1218266-4	1218266-3	02-01	02-08
		Socket	1218267-4	1218267-3	02-01	02-08
18 0.8	.083 2.11	Pin	1218266-2	1218266-1	02-01	02-08
		Socket	1218267-2	1218267-1	02-01	02-08

Tape mounted contacts are used in the AMP-TAPEMATIC Stripper/Crimper Machine Part Number 599406-7 (page 5142).

- Notes:** 1. These contacts are used in Series 109 connectors.
 2. Insertion/Extraction Tool Part Number 91067-2 (Military Part Number M81969/1-02) is used to install and remove pin and socket contacts.
 3. See AMP Instruction Sheet 408-7516 for wire length, tool and selector settings.

Size 20 Posted Contacts for Series 109 Connectors

Size 20 Posted Contacts

Material and Finish:

Pin and Socket Body —
Leaded nickel copper or beryllium copper, plated per chart below

Socket Hood —
See chart below



**Pin and Socket
Insertion/Extraction Tool**

AMP Part Number 91067-2 or
MIL Number M81969/1-02
Insertion tip, for replacement
Part Number 126195-3
Extraction tip, for replacement
Part Number 126195-4

Notes:

1. Contacts on this page can be used with connectors on pages 5105-5109, 5122, 5123 and 5139.
2. Mating End of pin and socket complies with MIL-C-39029.
3. See page 5144 for PCB layouts.

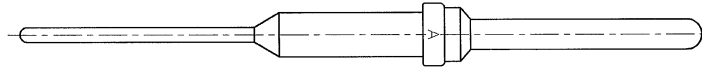

Pin
(See Drawing No. 212565 for latest configuration)

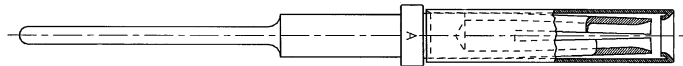

Socket
(See Drawing No. 208778 for latest configuration)

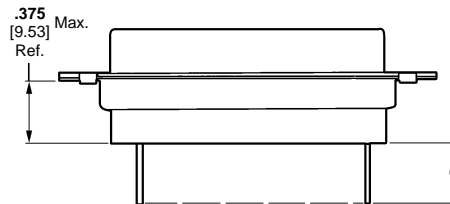

Post extension when used in a standard connector

Post Diameter ± .002 [± .050]	Post Extension C ± .025 [± 0.63]	Part Nos.		Contact Plating	Socket Hood Material and Finish
		Pin	Socket		
.018 0.46	.325 8.25	1-212565-0	1-208778-0	Gold .000050-.000100 [0.00127-0.00254] thick over .000150-.000250 [0.00381-0.00635] thick copper underplate	Passivated Stainless Steel
.018 0.46	.325 8.25	—	1-208778-1	Gold .000050-.000100 [0.00127-0.00254] thick over .000050-.000150 [0.00127-0.00381] thick nickel underplate	Passivated Stainless Steel
.018 0.46	.240 6.10	—	1-208778-2	Gold .000050-.000100 [0.00127-0.00254] thick over .000150-.000250 [0.00381-0.00635] thick copper underplate	Passivated Stainless Steel

Size 20 Posted Contacts for Series 109 Connectors (High Current Upgrade Program)

The High Current Size 20 contact has been designed to fit into the Series 109 AMPLIMITE Connectors per MIL-C-24308.

Material

Body — Copper Alloy
Louvertac Band — Beryllium Copper

Finish

Body — Gold
Louvertac Band — Gold

Current-Carrying Capacity. The High Current Size 20 contact with a 20 gage wire attached to the .030 [0.762] diameter solder tail acquired an initial 86°F [30°C] T-Rise of 11.85 amps in free air.

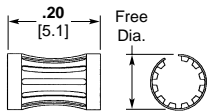

Multiple contact point due to hyperbolic shape.

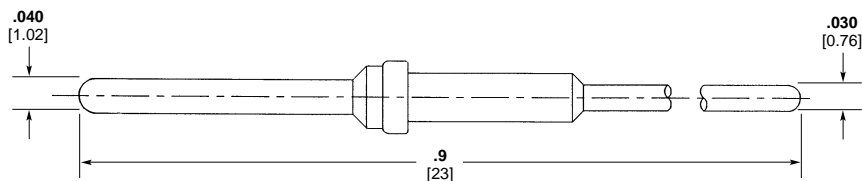
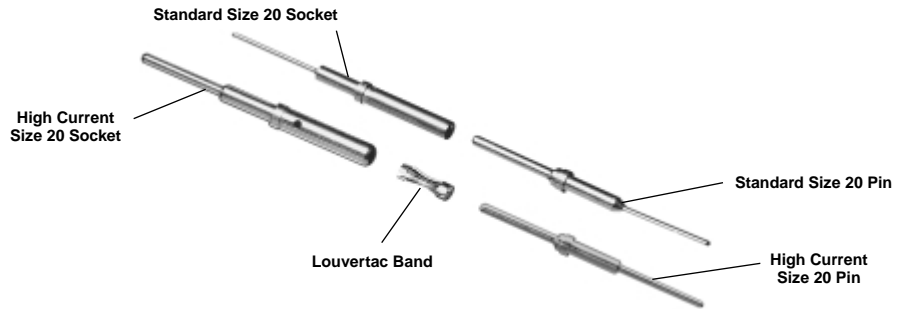

Pin Part Number 194081-1

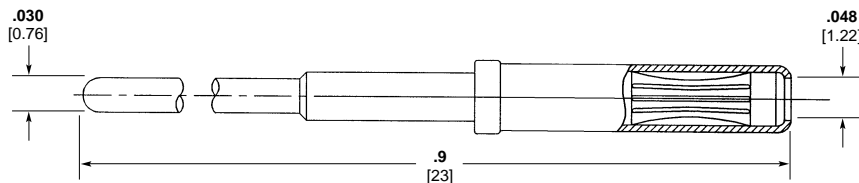

Socket Part Number 194083-1

The contacts can be sold loose piece or installed into any of the MIL Standard connectors.



Pin and Socket Insertion/Extraction Tool

Part Number 91067-2 or MIL number M81969/1-02

Insertion tip, for replacement Part Number 126195-3

Extraction tip, for replacement Part Number 126195-4

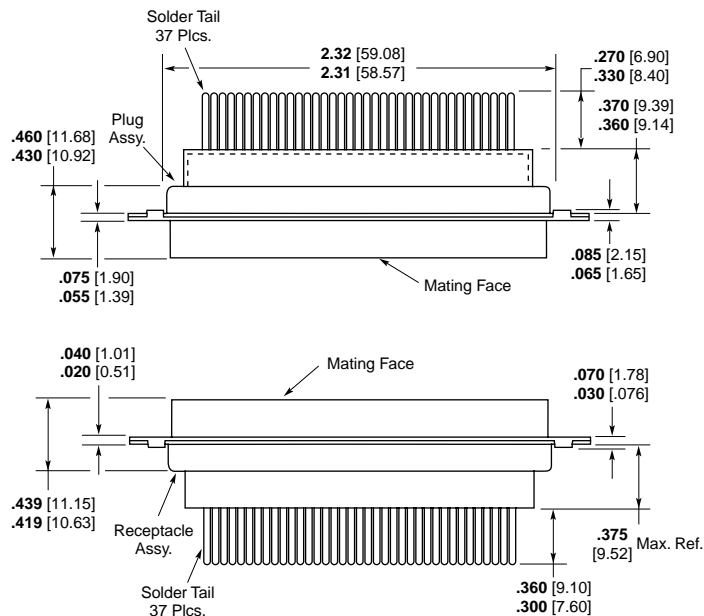

Typical Fully-Loaded 37 Position Plug and Receptacle

Notes: 1. High Current contacts with Louvertac bands are NOT intermateable with any other contact.

Material and Finish:

Shell — Steel, cadmium plated

Insert — Approved material per MIL-DTL-24308

Retention Clips — Stainless steel

Related Product Data:

Cavity Identification — page 5101

Contacts — pages 5102-5104

Mounting, Mating Specifications — page 5143

Accessories — pages 5148-5150

Attention: Connector marking

Connector marking may differ from package marking. All connectors marked per MIL-DTL-24308.

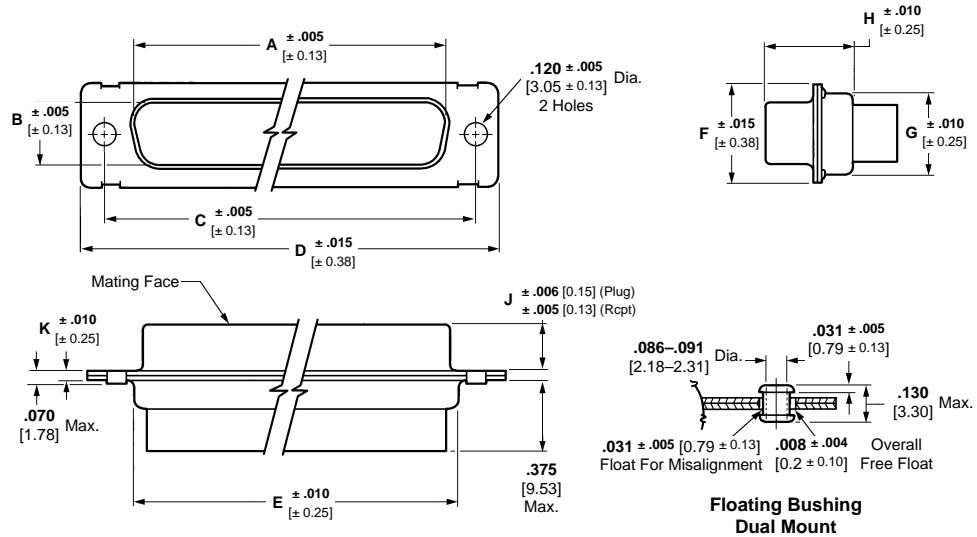

Series 109 Plugs per MIL-DTL-24308

No. of Contact Pos. (Shell Size)	Dimensions										Standard Mount		Floating Bushing Mount		Description
	A (Inside)	B (Inside)	C	D	E	F	G	H	J	K	Military Part No. M24308/	AMP Part No.	Military Part No. M24308/	AMP Part No.	
9 (1)	.666 16.92	.329 8.36	.984 24.99	1.213 30.81	.759 19.28	.494 12.55	.422 10.72	.422 10.72	.235 5.97	.030 0.76	4-259F	205162-1	4-324F	205412-1	Plug only
15 (2)	.994 25.25	.329 8.36	1.312 33.32	1.541 39.14	1.083 27.51	.494 12.55	.422 10.72	.422 10.72	.235 5.97	.030 0.76	4-260F	205164-1	4-325F	205408-1	Plug only
25 (3)	1.534 38.96	.329 8.36	1.852 47.04	2.088 53.04	1.625 41.3	.494 12.55	.422 10.72	.426 10.82	.230 5.84	.039 0.99	4-261F	205166-1	4-326F	205413-1	Plug only
37 (4)	2.182 55.42	.329 8.36	2.500 63.5	2.729 69.32	2.272 57.71	.494 12.55	.422 10.72	.426 10.82	.230 5.84	.039 0.99	4-262F	205168-1	4-327F	205414-1	Plug only
50 (5)	2.079 52.81	.441 11.2	2.406 61.11	2.635 66.93	2.178 55.32	.605 15.37	.534 13.56	.426 10.82	.230 5.84	.039 0.99	4-263F	205170-1	4-328F	205415-1	Plug only
											4-5F	205564-2	4-306F	205431-2	Plug with pins

Series 109 Receptacles per MIL-DTL-24308

No. of Contact Pos. (Shell Size)	Dimensions										Standard Mount		Floating Bushing Mount		Description
	A (Outside)	B (Outside)	C	D	E	F	G	H	J	K	Military Part No. M24308/	AMP Part No.	Military Part No. M24308/	AMP Part No.	
9 (1)	.643 16.33	.311 7.9	.984 24.99	1.213 30.81	.759 19.28	.494 12.55	.422 10.72	.429 10.9	.243 6.17	.030 0.76	2-281F	205161-1	2-292F	205416-1	Recept. only
15 (2)	.971 24.66	.311 7.9	1.312 33.32	1.541 39.14	1.083 27.51	.494 12.55	.422 10.72	.429 10.9	.243 6.17	.030 0.76	2-282F	205163-1	2-293F	205417-1	Recept. only
25 (3)	1.511 38.38	.311 7.9	1.852 47.04	2.088 53.04	1.625 41.3	.494 12.55	.422 10.72	.429 10.9	.243 6.17	.039 0.99	2-283F	205165-1	2-294F	205418-1	Recept. only
37 (4)	2.159 54.84	.311 7.9	2.500 63.5	2.729 69.32	2.272 57.71	.494 12.55	.422 10.72	.429 10.9	.243 6.17	.039 0.99	2-284F	205167-1	2-295F	205419-1	Recept. only
50 (5)	2.064 52.43	.423 10.74	2.406 61.11	2.635 66.93	2.178 55.32	.605 15.37	.534 13.56	.429 10.9	.243 6.17	.039 0.99	2-285F	205169-1	2-296F	205420-1	Recept. only
											2-5F	205563-2	2-27F	205432-2	Recept. with sockets

- Notes:**
- Size 20 contacts supplied with connectors are loose piece.
 - "F" is stamped on connectors following M24308 Part Number as required. "F" designates cadmium shell plating.
 - See pages 5151 through 5155 (Military to AMP Part Number cross reference) for additional part numbers.)

Crimp, Series 109, Standard Density Connectors (Industrial Grade)

Material and Finish:

Shell — Steel, zinc plated

Insert — Approved material per MIL-DTL-24308

Retention Clips — Stainless steel

Related Product Data:

Cavity Identification — page 5101

Contacts — pages 5102-5104

Mounting, Mating Specifications — page 5143

Accessories — pages 5148-5150

Attention: Connector marking

Connector marking may differ from package marking.

Note: Meets requirements of MIL-DTL-24308

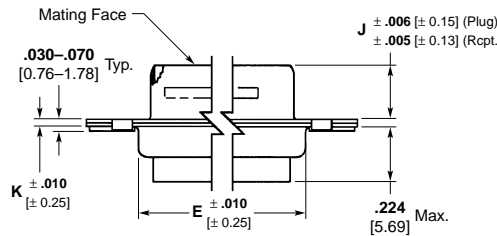
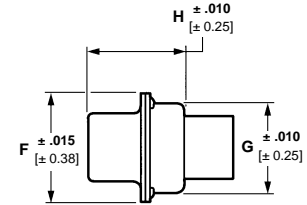
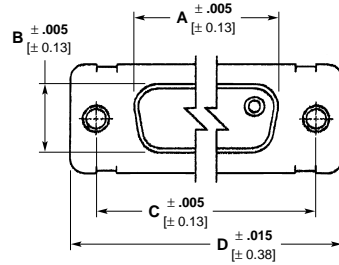

Clinch Nut Mount

Series 109 Plugs

No. of Contact Pos. (Shell Size)	Dimensions										Standard Mount Part No.	Description	
	A (Inside)	B (Inside)	C	D	E	F	G	H	J	K			
9 (1)	.666 16.92	.329 8.36	.984 24.99	1.213 30.81	.759 19.28	.494 12.55	.422 10.72	.422 10.72	.422 10.72	.235 5.97	.030 0.76	1218748-1	Plug only
15 (2)	.994 25.25	.329 8.36	1.312 33.32	1.541 39.14	1.083 27.51	.494 12.55	.422 10.72	.422 10.72	.422 10.72	.235 5.97	.030 0.76	1218748-2	Plug only
25 (3)	1.534 38.96	.329 8.36	1.852 47.04	2.088 53.04	1.625 41.3	.494 12.55	.422 10.72	.426 10.82	.426 10.82	.230 5.84	.039 0.99	1218748-3	Plug only
37 (4)	2.182 55.42	.329 8.36	2.500 63.5	2.729 69.32	2.272 57.71	.494 12.55	.422 10.72	.426 10.82	.426 10.82	.230 5.84	.039 0.99	1218748-4	Plug only
50 (5)	2.079 52.81	.441 11.2	2.406 61.11	2.635 66.93	2.178 55.32	.605 15.37	.534 13.56	.426 10.82	.426 10.82	.230 5.84	.039 0.99	1218748-5	Plug. only

Clinch Nut Mount available, contact Tyco Electronics.

Series 109 Receptacles

No. of Contact Pos. (Shell Size)	Dimensions										Clinch Nut Mount Part No.	Description	
	A (Inside)	B (Inside)	C	D	E	F	G	H	J	K			
9 (1)	.643 16.33	.311 7.9	.984 24.99	1.213 30.81	.759 19.28	.494 12.55	.422 10.72	.429 10.9	.429 10.9	.243 6.17	.030 0.76	1218749-1	Recept. only
15 (2)	.971 24.66	.311 7.9	1.312 33.32	1.541 39.14	1.083 27.51	.494 12.55	.422 10.72	.429 10.9	.429 10.9	.243 6.17	.030 0.76	1218749-2	Recept. only
25 (3)	1.511 38.38	.311 7.9	1.852 47.04	2.088 53.04	1.625 41.3	.494 12.55	.422 10.72	.429 10.9	.429 10.9	.243 6.17	.039 0.99	1218749-3	Recept. only
37 (4)	2.159 54.84	.311 7.9	2.500 63.5	2.729 69.32	2.272 57.71	.494 12.55	.422 10.72	.429 10.9	.429 10.9	.243 6.17	.039 0.99	1218749-4	Recept. only
50 (5)	2.064 52.43	.423 10.74	2.406 61.11	2.635 66.93	2.178 55.32	.605 15.37	.534 13.56	.429 10.9	.429 10.9	.243 6.17	.039 0.99	1218749-5	Recept. only

Standard Mount available, contact Tyco Electronics.

Non-Magnetic Crimp Plugs, Series 109, Standard Density Connectors (NASA Qualified)

Connector Material and Finish:
Shell — Brass, gold plated
Insert — Approved material per MIL-DTL-24308
Retention Clips — Copper alloy
Related Product Data:
Cavity Identification — page 5101
Mounting, Mating Specifications — page 5143
Accessories — pages 5148-5150

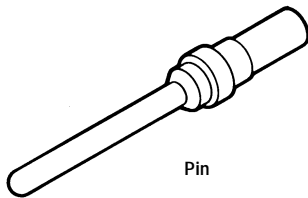
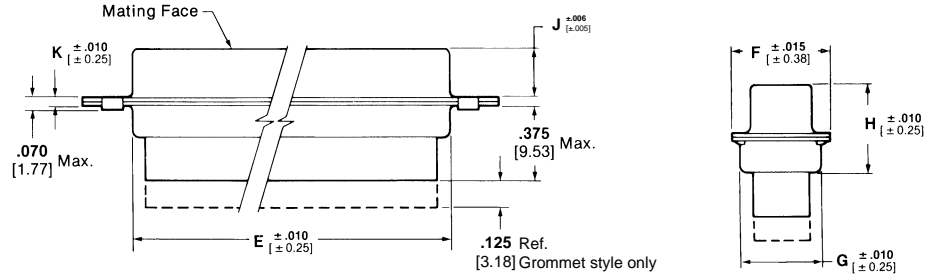
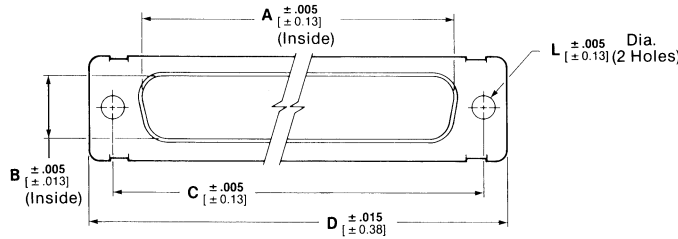

Pin

Pin Contact

Wire Size Range	AMP Part No. / NASA No.
26-28 0.15-0.08	206794-2
20-24 0.6-0.2	205089-4 G-10-P1

Strip length .140 [3.56]
 Max. insulation diameter .072 [1.83]
 Hand tool M22520/2-01 or AMP Part Number 601966-1
 Positioner M22520/2-08 or AMP Part Number 601966-5

Contact Material and Finish:
 Copper alloy plated gold
 .00050-.000100 [0.00127-.00254]
 thick over .000100-.000150
 [0.00254-.00381] copper underplate



Pin and Socket Insertion/Extraction Tool

AMP Part Number 91067-2 or MIL Number M81969/1-02
 Insertion tip, for replacement Part Number 126195-3
 Extraction tip, for replacement Part Number 126195-4

Non-Magnetic Plugs per NASA Specification

No. of Contact Pos. (Shell Size)	Dimensions											NASA No.	AMP Part No.
	A	B	C	D	E	F	G	H	J	K	L		
9 (1)	.666	.329	.984	1.213	.759	.494	.422	.422	.235	.030	.154	311P409-1P-B-15	207252-1
	16.92	8.36	24.99	30.81	19.28	12.55	10.72	10.72	5.97	0.76	3.91		
15 (2)	.994	.329	1.312	1.541	1.083	.494	.422	.422	.235	.030	.154	311P409-2P-B-15	206798-1
	25.25	8.36	33.32	39.14	27.51	12.55	10.72	10.72	5.97	0.76	3.91		
25 (3)	1.534	.329	1.852	2.088	1.625	.494	.422	.426	.230	.039	.154	311P409-3P-B-15	206800-1
	38.96	8.36	47.04	53.04	41.3	12.55	10.72	10.82	5.84	0.99	3.91		
37 (4)	2.182	.329	2.500	2.729	2.272	.494	.422	.426	.230	.039	.154	311P409-4P-B-15	206802-1
	55.42	8.36	63.5	69.32	57.71	12.55	10.72	10.82	5.84	0.99	3.91		
50 (5)	2.079	.441	2.406	2.635	2.178	.605	.534	.426	.230	.039	.154	311P409-5P-B-15	206804-1
	52.81	11.20	61.11	66.93	55.32	15.37	13.56	10.82	5.84	0.99	3.91		

Non-Magnetic Plugs With Silicone Rubber Rear Grommet¹

No. of Contact Pos. (Shell Size)	Dimensions											AMP Part No.
	A	B	C	D	E	F	G	H	J	K	L	
9 (1)	.666	.329	.984	1.213	.759	.494	.422	.422	.235	.030	.120	211638-4
	16.92	8.36	24.99	30.81	19.28	12.55	10.72	10.72	5.97	0.76	3.05	
15 (2)	.994	.329	1.312	1.541	1.083	.494	.422	.422	.235	.030	.120	211639-4
	25.25	8.36	33.32	39.14	27.51	12.55	10.72	10.72	5.97	0.76	3.05	
25 (3)	1.534	.329	1.852	2.088	1.625	.494	.422	.426	.230	.039	.120	211640-4
	38.96	8.36	47.04	53.04	41.3	12.55	10.72	10.82	5.84	0.99	3.05	
37 (4)	2.182	.329	2.500	2.729	2.272	.494	.422	.426	.230	.039	.120	211641-4
	55.42	8.36	63.5	69.32	57.71	12.55	10.72	10.82	5.84	0.99	3.05	
50 (5)	2.079	.441	2.406	2.635	2.178	.605	.534	.426	.230	.039	.120	211642-4
	52.81	11.20	61.11	66.93	55.32	15.37	13.56	10.82	5.84	0.99	3.05	

¹ Grommet provided for cable strain relief.

Non-Magnetic Crimp Receptacles, Series 109, Standard Density Connectors (NASA Qualified)

Connector Material and Finish:

Shell — Brass, gold plated

Insert — Approved material per MIL-DTL-24308

Retention Clips — Copper alloy

Related Product Data:

Cavity Identification — page 5101

Mounting, Mating Specifications — page 5143

Accessories — pages 5148-5150

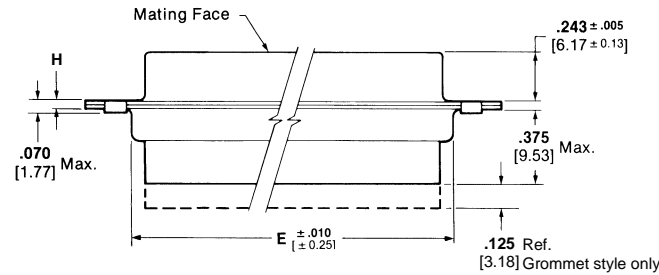
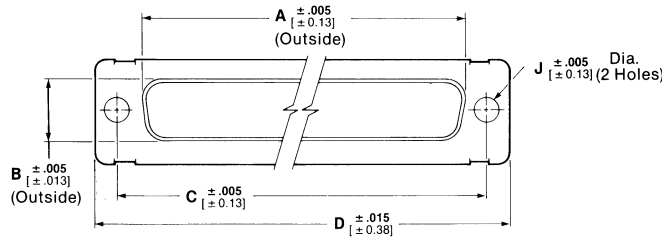
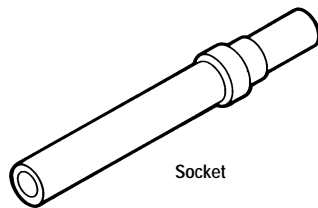

Socket Contact

Wire Size Range	AMP Part No. / NASA No.
26-28 0.15-0.08	206795-1 —
20-24 0.6-0.2	206793-1 G-10-S1

Strip length .140 [3.56]
Max. insulation diameter .072 [1.83]
Hand tool M22520/2-01 or AMP Part Number 601966-1
Positioner M22520/2-08 or AMP Part Number 601966-5

Contact Material and Finish:

Copper alloy plated gold
.000050-.000100 [0.00127-0.00254]
thick over .000100-.000150
[0.00254-0.00381] copper underplate

Non-Magnetic Receptacles per NASA Specification

No. of Contact Pos. (Shell Size)	Dimensions										NASA No.	AMP Part No.
	A	B	C	D	E	F	G	H	J			
9 (1)	.643	.311	.984	1.213	.759	.494	.422	.030	.154	3.91	311P409-1S-B-15	207253-1
	16.33	7.9	24.99	30.81	19.28	12.55	10.72	0.76	3.91	3.05		
15 (2)	.971	.311	1.312	1.541	1.083	.494	.422	.030	.154	3.91	311P409-2S-B-15	206799-1
	24.66	7.9	33.32	39.14	27.51	12.55	10.72	0.76	3.91	3.05		
25 (3)	1.511	.311	1.852	2.088	1.625	.494	.422	.039	.154	3.91	311P409-3S-B-15	206801-1
	38.38	7.9	47.04	53.04	41.3	12.55	10.72	0.99	3.91	3.05		
37 (4)	2.159	.311	2.500	2.729	2.272	.494	.422	.039	.154	3.91	311P409-4S-B-15	206803-1
	55.42	7.9	63.5	69.32	57.71	12.55	10.72	0.99	3.91	3.05		
50 (5)	2.064	.423	2.406	2.635	2.178	.605	.534	.039	.154	3.91	311P409-5S-B-15	206805-1
	52.43	10.74	61.11	66.93	55.32	15.37	13.56	0.99	3.91	3.05		

Non-Magnetic Receptacles With Silicone Rubber Rear Grommet¹

No. of Contact Pos. (Shell Size)	Dimensions										AMP Part No.
	A	B	C	D	E	F	G	H	J		
9 (1)	.643	.311	.984	1.213	.759	.494	.422	.030	.120	3.05	211633-4
15 (2)	.971	.311	1.312	1.541	1.083	.494	.422	.030	.120	3.05	
25 (3)	1.511	.311	1.852	2.088	1.625	.494	.422	.039	.120	3.05	211635-4
37 (4)	2.159	.311	2.500	2.729	2.272	.494	.422	.039	.120	3.05	
50 (5)	2.064	.423	2.406	2.635	2.178	.605	.534	.039	.120	3.05	211637-4
	52.43	10.74	61.11	66.93	55.32	15.37	13.56	0.99	3.05		

¹ Grommet provided for cable strain relief.



AMP Part Number 91067-2 or MIL Number M81969/1-02
Insertion tip, for replacement Part Number 126195-3
Extraction tip, for replacement Part Number 126195-4

Crimp, Blindmate Plugs, Series 109, Standard Density Connectors

Materials and Finish:

Shell, Front — Aluminum alloy, cadmium plated with yellow chromate

Shell, Rear — Steel, cadmium plated with yellow chromate

Insert Assembly — Approved material per MIL-DTL-24308

Retention Clips — Stainless steel

Related Product Data:

Cavity Identification — page 5101

Contacts — pages 5102-5104

Mounting Specifications — page 5143

Mating information contained on page 5143 does not pertain to Blindmate design. Flange to flange spacing can be a max. of .270 [6.86].

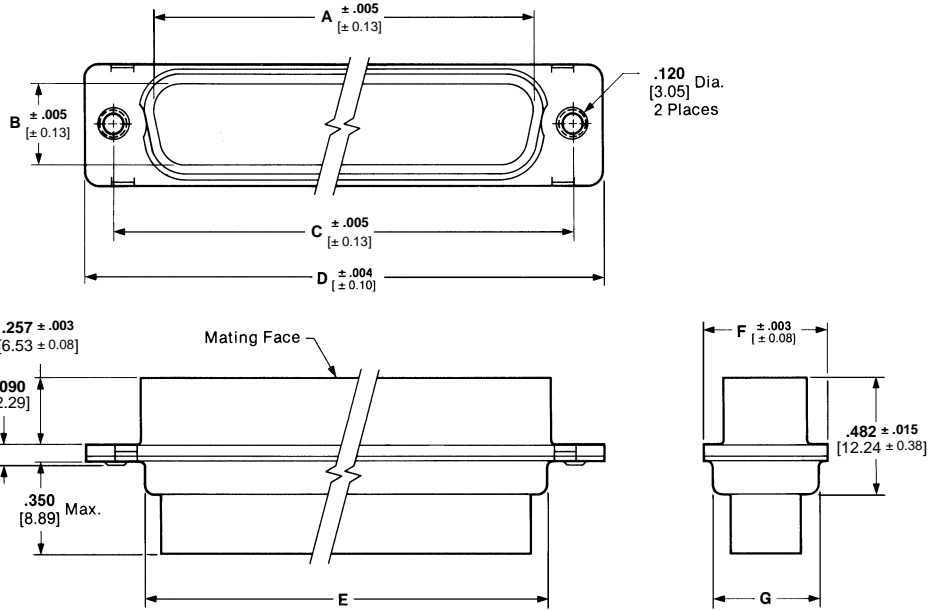

No. of Contact Pos. (Shell Size)	Dimensions							AMP Part No.
	A	B	C	D	E	F	G	
9 (1)	.656 16.66	.324 8.23	.984 24.99	1.224 31.09	.769/1.750 19.53/19.05	.506 12.85	.432/.413 10.97/10.49	445005-1
15 (2)	.984 25.0	.324 8.23	1.312 33.32	1.552 39.42	1.093/1.074 27.76/27.28	.506 12.85	.432/.413 10.97/10.49	445006-1
25 (3)	1.524 38.71	.324 8.23	1.852 47.04	2.099 53.31	1.635/1.616 41.53/41.05	.506 12.85	.432/.413 10.97/10.49	445007-1
37 (4)	2.172 55.17	.324 8.23	2.500 63.5	2.740 69.60	2.282/2.263 57.96/57.48	.506 12.85	.432/.413 10.97/10.49	445008-1
50 (5)	2.082 52.88	.444 11.28	2.406 61.11	2.646 67.21	2.188/2.167 55.58/55.04	.617 15.67	.544/.525 13.82/13.34	445009-1

Note: See page 5122 for Blindmate coax/signal combinations.

Straight PCB, Series 109, Standard Density Connectors (MIL Qualified)

Material and Finish:

- Shell** — Steel, cadmium plated
- Insert** — Approved material per MIL-DTL-24308
- Contact** — Copper alloy plated gold over nickel underplate*
- Spacer** — Aluminum alloy, Iridite finish

Related Product Data:

- Cavity Identification** — page 5101
- Mounting, Mating Specifications** — page 5143
- Accessories** — pages 5148-5150
- PCB Layouts** — See page 5144 or AMP customer drawing.
- *Socket Body** — .000050 [0.00127] min. gold over .000050 [0.00127] min. nickel
- Mating Area** — .000050 [0.00127] min. gold over .000050 [0.00127] min. nickel
- Plug Body** — .000050 [0.00127] min. gold over .000050 [0.00127] min. nickel

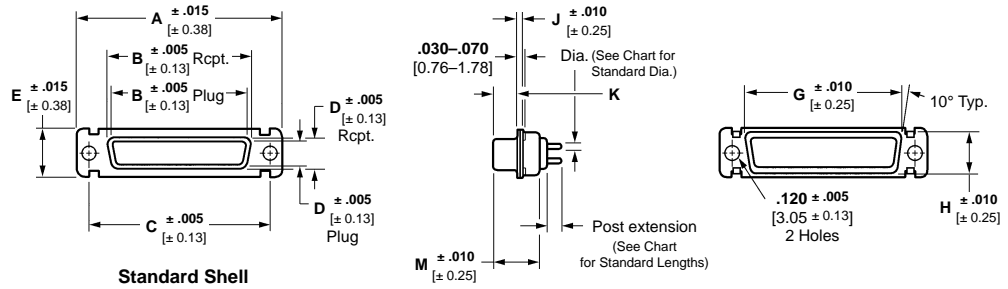

Standard Shell

MS Shell Size	Connector Style	Dimensions									
		A	B	C	D	E	G	H	J	K	M
1	Plug	1.213 30.81	.666 16.92	.984 24.99	.329 8.36	.494 12.55	.759 19.28	.422 10.72	.030 0.76	.238/.229 6.04/5.81	.422 10.72
	Receptacle	1.213 30.81	.643 16.33	.984 24.99	.311 7.90	.494 12.55	.759 19.28	.422 10.72	.030 0.76	.248/.238 6.29/6.04	.429 10.90
2	Plug	1.541 39.14	.994 25.25	1.312 33.32	.329 8.36	.494 12.55	1.083 27.51	.422 10.72	.030 0.76	.238/.229 6.04/5.81	.422 10.72
	Receptacle	1.541 39.14	.971 24.66	1.312 33.32	.311 7.90	.494 12.55	1.083 27.51	.422 10.72	.030 0.76	.248/.238 6.29/6.04	.429 10.90
3	Plug	2.088 53.04	1.534 38.96	1.852 47.04	.329 8.36	.494 12.55	1.625 41.28	.422 10.72	.039 0.99	.236/.224 5.99/5.68	.426 10.82
	Receptacle	2.088 53.04	1.511 38.38	1.852 47.04	.311 7.90	.494 12.55	1.625 41.28	.422 10.72	.030 0.76	.248/.238 6.29/6.04	.429 10.90
4	Plug	2.729 69.32	2.182 55.42	2.500 63.5	.329 8.36	.494 12.55	2.272 57.71	.422 10.72	.039 0.99	.236/.224 5.99/5.68	.426 10.82
	Receptacle	2.729 69.32	2.159 54.84	2.500 63.5	.311 7.90	.494 12.55	2.272 57.71	.422 10.72	.030 0.76	.248/.238 6.29/6.04	.429 10.90
5	Plug	2.635 66.93	2.079 52.81	2.406 61.11	.441 11.20	.605 15.37	2.178 55.32	.534 13.56	.039 0.99	.236/.224 5.99/5.68	.426 10.82
	Receptacle	2.635 66.93	2.064 52.43	2.406 61.11	.423 10.74	.605 15.37	2.178 55.32	.534 13.55	.030 0.76	.248/.238 6.29/6.04	.429 10.90

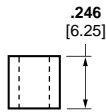

Spacer

Receptacle Assemblies

Shell Size	No. Pos.	Post Dia.	Post Ext. ±.020 [± 0.51]	Military Part No. M24308/	AMP Part No.
1	9	.030 0.76	.156 3.96	23-1F	443975-1
2	15	.030 0.76	.156 3.96	23-2F	443975-2
3	25	.030 0.76	.156 3.96	23-3F	443975-3
4	37	.030 0.76	.156 3.96	23-4F	443975-4
5	50	.030 0.76	.156 3.96	23-5F	443975-5
1	9	.030 0.76	.188 4.78	23-7F	443976-1
2	15	.030 0.76	.188 4.78	23-8F	443976-2
3	25	.030 0.76	.188 4.78	23-9F	443976-3
4	37	.030 0.76	.188 4.78	23-10F	443976-4
5	50	.030 0.76	.188 4.78	23-11F	443976-5
1	9	.040 1.02	.156 3.96	23-13F	443977-1
2	15	.040 1.02	.156 3.96	23-14F	443977-2
3	25	.040 1.02	.156 3.96	23-15F	443977-3
4	37	.040 1.02	.156 3.96	23-16F	443977-4
5	50	.040 1.02	.156 3.96	23-17F	443977-5
1	9	.040 1.02	.188 4.78	23-19F	443978-1
2	15	.040 1.02	.188 4.78	23-20F	443978-2
3	25	.040 1.02	.188 4.78	23-21F	443978-3
4	37	.040 1.02	.188 4.78	23-22F	443978-4
5	50	.040 1.02	.188 4.78	23-23F	443978-5

Plug Assemblies

Shell Size	No. Pos.	Post Dia.	Post Ext. ±.020 [± 0.51]	Military Part No. M24308/	AMP Part No.
1	9	.030 0.76	.156 3.96	24-1F	1218124-1
2	15	.030 0.76	.156 3.96	24-2F	1218124-2
3	25	.030 0.76	.156 3.96	24-3F	1218124-3
4	37	.030 0.76	.156 3.96	24-4F	1218124-4
5	50	.030 0.76	.156 3.96	24-5F	1218124-5
1	9	.030 0.76	.188 4.78	24-7F	1218125-1
2	15	.030 0.76	.188 4.78	24-8F	1218125-2
3	25	.030 0.76	.188 4.78	24-9F	1218125-3
4	37	.030 0.76	.188 4.78	24-10F	1218125-4
5	50	.030 0.76	.188 4.78	24-11F	1218125-5
1	9	.040 1.02	.156 3.96	24-13F	1218126-1
2	15	.040 1.02	.156 3.96	24-14F	1218126-2
3	25	.040 1.02	.156 3.96	24-15F	1218126-3
4	37	.040 1.02	.156 3.96	24-16F	1218126-4
5	50	.040 1.02	.156 3.96	24-17F	1218126-5
1	9	.040 1.02	.188 4.78	24-19F	1218127-1
2	15	.040 1.02	.188 4.78	24-20F	1218127-2
3	25	.040 1.02	.188 4.78	24-21F	1218127-3
4	37	.040 1.02	.188 4.78	24-22F	1218127-4
5	50	.040 1.02	.188 4.78	24-23F	1218127-5

Straight PCB, Series 109, Standard Density Connectors (Industrial Grade)

Material and Finish:

Shell — Steel, see below

Insert — Approved material per MIL-DTL-24308

Contact — Copper alloy plated gold over nickel underplate*

Spacer — Aluminum alloy, Iridite finish

Related Product Data:

Cavity Identification — page 5101

Mounting, Mating Specifications — page 5143

Accessories — pages 5148-5150

PCB Layouts — See page 5144 or AMP customer drawing.

***aSocket Body and Mating Area** —

.000050 [0.00127] min. gold over
.000050 [0.00127] min. nickel

Plug Body and Mating Area —

.000050 [0.00127] min. gold over
.000050 [0.00127] min. nickel

bMating Area — Copper alloy with
.000030 [0.00076] min. gold plate over
.000050 [0.00127] min. nickel underplate

Product Specification — 108-1770

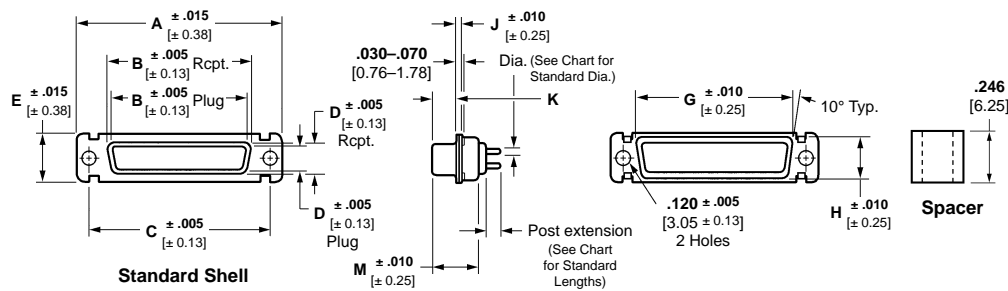

MS Shell Size	Connector Style	Dimensions									
		A	B	C	D	E	G	H	J	K	M
1	Plug	1.213 30.81	.666 16.92	.984 24.99	.329 8.36	.494 12.55	.759 19.28	.422 10.72	.030 0.76	.238/.229 6.04/5.81	.422 10.72
	Receptacle	1.213 30.81	.643 16.33	.984 24.99	.311 7.90	.494 12.55	.759 19.28	.422 10.72	.030 0.76	.248/.238 6.29/6.04	.429 10.90
2	Plug	1.541 39.14	.994 25.25	1.312 33.32	.329 8.36	.494 12.55	1.083 27.51	.422 10.72	.030 0.76	.238/.229 6.04/5.81	.422 10.72
	Receptacle	1.541 39.14	.971 24.66	1.312 33.32	.311 7.90	.494 12.55	1.083 27.51	.422 10.72	.030 0.76	.248/.238 6.29/6.04	.429 10.90
3	Plug	2.088 53.04	1.534 38.96	1.852 47.04	.329 8.36	.494 12.55	1.625 41.28	.422 10.72	.039 0.99	.236/.224 5.99/5.68	.426 10.82
	Receptacle	2.088 53.04	1.511 38.38	1.852 47.04	.311 7.90	.494 12.55	1.625 41.28	.422 10.72	.030 0.76	.248/.238 6.29/6.04	.429 10.90
4	Plug	2.729 69.32	2.182 55.42	2.500 63.5	.329 8.36	.494 12.55	2.272 57.71	.422 10.72	.039 0.99	.236/.224 5.99/5.68	.426 10.82
	Receptacle	2.729 69.32	2.159 54.84	2.500 63.5	.311 7.90	.494 12.55	2.272 57.71	.422 10.72	.030 0.76	.248/.238 6.29/6.04	.429 10.90
5	Plug	2.635 66.93	2.079 52.81	2.406 61.11	.441 11.20	.605 15.37	2.178 55.32	.534 13.56	.039 0.99	.236/.224 5.99/5.68	.426 10.82
	Receptacle	2.635 66.93	2.064 52.43	2.406 61.11	.423 10.74	.605 15.37	2.178 55.32	.534 13.55	.030 0.76	.248/.238 6.29/6.04	.429 10.90

Shell Size	No. Pos.	Post Dia.	Post Ext. ±.020 [± 0.51]	Receptacle Part No.		
				Tin Plated Shells ^a	Tin Plated Shells ^b	Zinc Plated Shells ^a
1	9	.030 0.76	.156 3.96	1218826-1	1218293-1	1218289-1
2	15	.030 0.76	.156 3.96	1218826-2	1218293-2	1218289-2
3	25	.030 0.76	.156 3.96	1218826-3	1218293-3	1218289-3
4	37	.030 0.76	.156 3.96	1218826-4	1218293-4	1218289-4
5	50	.030 0.76	.156 3.96	1218826-5	1218293-5	1218289-5
1	9	.030 0.76	.188 4.78	1218827-1	1218294-1	1218290-1
2	15	.030 0.76	.188 4.78	1218827-2	1218294-2	1218290-2
3	25	.030 0.76	.188 4.78	1218827-3	1218294-3	1218290-3
4	37	.030 0.76	.188 4.78	1218827-4	1218294-4	1218290-4
5	50	.030 0.76	.188 4.78	1218827-5	1218294-5	1218290-5
1	9	.040 1.02	.156 3.96	1218828-1	1218295-1	1218291-1
2	15	.040 1.02	.156 3.96	1218828-2	1218295-2	1218291-2
3	25	.040 1.02	.156 3.96	1218828-3	1218295-3	1218291-3
4	37	.040 1.02	.156 3.96	1218828-4	1218295-4	1218291-4
5	50	.040 1.02	.156 3.96	1218828-5	1218295-5	1218291-5
1	9	.040 1.02	.188 4.78	1218829-1	1218296-1	1218292-1
2	15	.040 1.02	.188 4.78	1218829-2	1218296-2	1218292-2
3	25	.040 1.02	.188 4.78	1218829-3	1218296-3	1218292-3
4	37	.040 1.02	.188 4.78	1218829-4	1218296-4	1218292-4
5	50	.040 1.02	.188 4.78	1218829-5	1218296-5	1218292-5

Shell Size	No. Pos.	Post Dia.	Post Ext. ±.020 [± 0.51]	Plug Part No.	
				Tin Plated Shells ^a	Zinc Plated Shells ^a
1	9	.030 0.76	.156 3.96	1218374-1	1218378-1
2	15	.030 0.76	.156 3.96	1218374-2	1218378-2
3	25	.030 0.76	.156 3.96	1218374-3	1218378-3
4	37	.030 0.76	.156 3.96	1218374-4	1218378-4
5	50	.030 0.76	.156 3.96	1218374-5	1218378-5
1	9	.030 0.76	.188 4.78	1218375-1	1218379-1
2	15	.030 0.76	.188 4.78	1218375-2	1218379-2
3	25	.030 0.76	.188 4.78	1218375-3	1218379-3
4	37	.030 0.76	.188 4.78	1218375-4	1218379-4
5	50	.030 0.76	.188 4.78	1218375-5	1218379-5
1	9	.040 1.02	.156 3.96	1218376-1	1218380-1
2	15	.040 1.02	.156 3.96	1218376-2	1218380-2
3	25	.040 1.02	.156 3.96	1218376-3	1218380-3
4	37	.040 1.02	.156 3.96	1218376-4	1218380-4
5	50	.040 1.02	.156 3.96	1218376-5	1218380-5
1	9	.040 1.02	.188 4.78	1218377-1	1218381-1
2	15	.040 1.02	.188 4.78	1218377-2	1218381-2
3	25	.040 1.02	.188 4.78	1218377-3	1218381-3
4	37	.040 1.02	.188 4.78	1218377-4	1218381-4
5	50	.040 1.02	.188 4.78	1218377-5	1218381-5

Straight PCB, Series 109, "Make First Break Last" Sub-D Connectors (Industrial Grade)

Material and Finish:

Shell — Steel, cadmium or tin plated

Insert — Polyester per MIL-M-24519

Contact — Copper alloy with .000030 [0.00076] min. gold plate over .000050 [0.00127] min. nickel underplate

Regular Length Contact Location: 1, 6, and 9

Short Length Contact Location: 2 thru 5, 7, and 8

Finish — Cadmium per QQ-P-416

Finish — Tin plated per MIL-T-10727

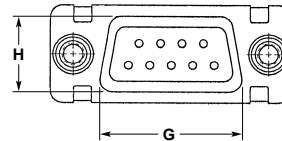
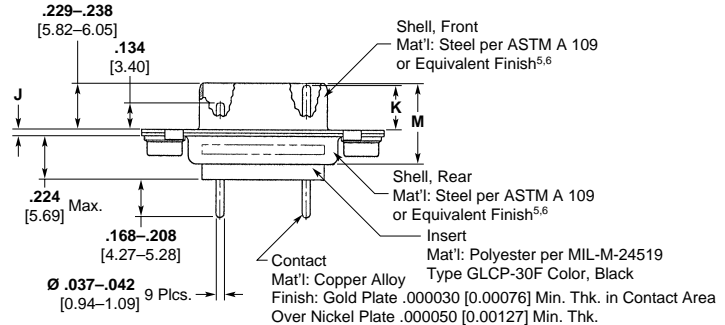
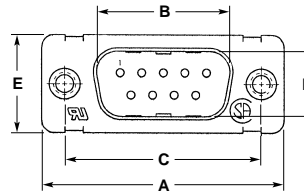

MS Shell Size	Connector Style	Dimensions									
		A	B	C	D	E	G	H	J	K	M
1	Plug	1.213 30.81	.666 16.92	.984 24.99	.329 8.36	.494 12.55	.759 19.28	.422 10.72	.020/.040 0.51/1.02	.223 5.66	.412/.432 10.46/10.97
	Receptacle	1.213 30.81	.643 16.33	.984 24.99	.311 7.90	.494 12.55	.759 19.28	.422 10.72	.238/.248 6.05/6.30	.178 4.52	.419/.439 10.64/11.15
2	Receptacle	1.541 39.14	.971 24.66	1.312 33.32	.311 7.90	.494 12.55	1.083 27.51	.422 10.72	.238/.248 6.05/6.30	.178 4.52	.419/.439 10.64/11.15
3	Plug	2.088 53.04	1.534 38.96	1.852 47.04	.329 8.36	.494 12.55	1.625 41.28	.422 10.72	.029/.049 0.74/1.24	.217 5.51	.416/.435 10.57/11.07

Plug Assemblies

Shell Size	No. Pos.	Post Dia.	Plug Part No.	
			Tin Plated Shells	Cadmium Plated Shells
1	9	.037/.043 0.94/1.09	443638-2	443638-1
3	25	.037/.043 0.94/1.09	443631-2	443631-1

Receptacle Assemblies

Shell Size	No. Pos.	Post Dia.	Plug Part No.	
			Tin Plated Shells	Cadmium Plated Shells
1	9	.037/.043 0.94/1.09	443637-2	443637-1
2	15	.037/.043 0.94/1.09	443646-2	443646-1

Right-Angle, PCB Plugs, Series 109, Standard Density Connectors (MIL Qualified)

Material and Finish:

Shell — Steel, cadmium plated
 Insert and Post Spacer — Approved material per MIL-DTL-24308
 Contact — Copper alloy with .000050 [0.00127] min. gold plate over .000050 [0.00127] min. nickel underplate

Related Product Data:

Cavity Identification — page 5101
 Mounting, Mating Specifications — page 5143
 Accessories — pages 5148-5150
 PCB Layouts — See page 5144 or AMP customer drawing.

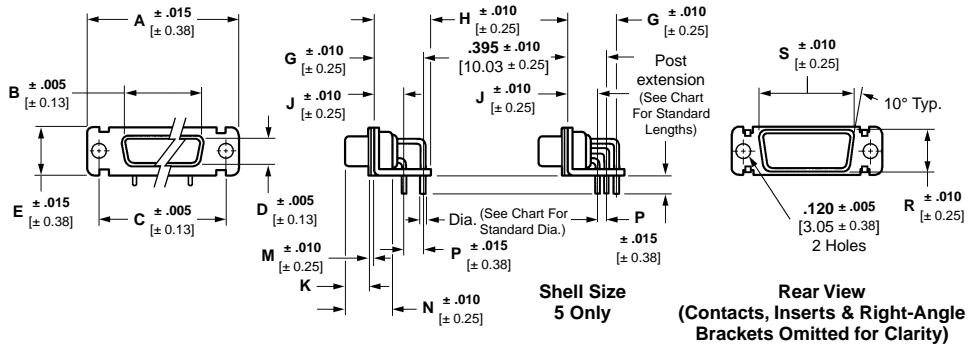

MS Shell Size	Connector Style	Dimensions													
		A	B	C	D	E	G	H	J	K	M	N	P	R	S
1	Plug	1.213	.666	.984	.329	.494	.395	.484	.283	.238/.229	.030	.422	.112	.422	.759
		30.81	16.92	24.99	8.36	12.55	10.03	12.29	7.19	6.04/5.81	0.76	10.72	2.84	10.72	19.28
2	Plug	1.541	.994	1.312	.329	.494	.395	.484	.283	.238/.229	.030	.422	.112	.422	1.083
		39.14	25.25	33.33	8.36	12.55	10.03	12.29	7.19	6.04/5.81	0.76	10.72	2.84	10.72	27.51
3	Plug	2.088	1.534	1.852	.329	.494	.395	.484	.283	.236/.224	.039	.426	.112	.422	1.625
		53.04	38.96	47.04	8.36	12.55	10.03	12.29	7.19	5.99/5.68	0.99	10.82	2.84	10.72	29.59
4	Plug	2.729	2.182	2.500	.329	.494	.395	.484	.283	.236/.224	.039	.426	.112	.422	2.272
		69.32	55.42	63.5	8.36	12.55	10.03	12.29	7.19	5.99/5.68	0.99	10.82	2.84	10.72	57.71
5	Plug	2.635	2.079	2.406	.441	.605	.507	.594	.283	.236/.224	.039	.426	.112	.534	2.178
		66.93	52.81	61.11	10.44	15.37	12.88	15.09	7.19	5.99/5.68	0.99	10.82	2.84	13.56	55.32

Plug Assemblies — .030 [0.76] Post Dia.

Shell Size	No. Pos.	Post Ext. ±.020 [±0.51]	Military Part No. M24308/	AMP Part No.
1	9	.125 3.18	24-25F	1218440-1
2	15	.125 3.18	24-26F	1218440-2
3	25	.125 3.18	24-27F	1218440-3
4	37	.125 3.18	24-28F	1218440-4
5	50	.125 3.18	24-29F	1218440-5
1	9	.156 3.96	24-31F	1218441-1
2	15	.156 3.96	24-32F	1218441-2
3	25	.156 3.96	24-33F	1218441-3
4	37	.156 3.96	24-34F	1218441-4
5	50	.156 3.96	24-35F	1218441-5
1	9	.188 4.78	24-49F	1218444-1
2	15	.188 4.78	24-50F	1218444-2
3	25	.188 4.78	24-51F	1218444-3
4	37	.188 4.78	24-52F	1218444-4
5	50	.188 4.78	24-53F	1218444-5

Plug Assemblies — .040 [1.02] Post Dia.

Shell Size	No. Pos.	Post Ext. ±.020 [±0.51]	Military Part No. M24308/	AMP Part No.
1	9	.125 3.18	24-37F	1218442-1
2	15	.125 3.18	24-38F	1218442-2
3	25	.125 3.18	24-39F	1218442-3
4	37	.125 3.18	24-40F	1218442-4
5	50	.125 3.18	24-41F	1218442-5
1	9	.156 3.96	24-43F	1218443-1
2	15	.156 3.96	24-44F	1218443-2
3	25	.156 3.96	24-45F	1218443-3
4	37	.156 3.96	24-46F	1218443-4
5	50	.156 3.96	24-47F	1218443-5
1	9	.188 4.78	24-55F	1218445-1
2	15	.188 4.78	24-56F	1218445-2
3	25	.188 4.78	24-57F	1218445-3
4	37	.188 4.78	24-58F	1218445-4
5	50	.188 4.78	24-59F	1218445-5

Note: The suffix "F" on M24308 part numbers designates cadmium shell plating.

Right-Angle, PCB Receptacles, Series 109, Standard Density Connectors (MIL Qualified)

Material and Finish:

- Shell — Steel, cadmium plated
- Insert and Post Spacer — Approved material per MIL-DTL-24308
- Contacts —
- Socket Body — Copper alloy with .000050 [0.00127] min. gold plate over .000050 [0.00127] min. nickel underplate
- Mating Area — Copper alloy with .000050 [0.00127] min. gold plate over .000050 [0.00127] min. nickel underplate

Related Product Data:

- Cavity Identification — page 5101
- Mounting, Mating Specifications — page 5143
- Accessories — pages 5148-5150
- PCB Layouts — See page 5144 or AMP customer drawing.

9, 15, 25 and 37 Positions

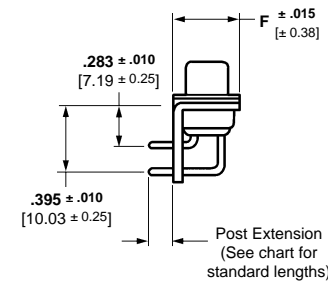
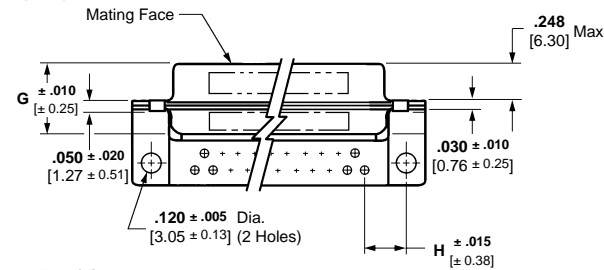

50 Positions

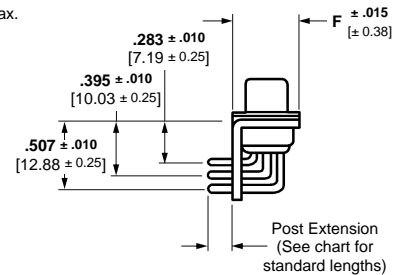
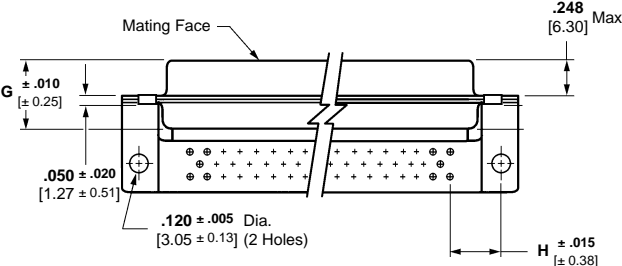

Receptacle Assemblies

No. of Contact Pos. (Shell Size)	Dimensions						
	A (Outside)	B (Outside)	C	D	F	G	H
9 (1)	.643 16.33	.311 7.9	.984 24.99	1.213 30.81	.494 12.55	.429 10.97	.276 7.01
15 (2)	.971 24.66	.311 7.9	1.312 33.32	1.541 39.14	.494 12.55	.429 10.97	.278 7.06
25 (3)	1.511 38.38	.311 7.9	1.852 47.04	2.088 53.04	.494 12.55	.429 10.97	.274 6.96
37 (4)	2.159 54.84	.311 7.9	2.500 63.5	2.729 69.32	.494 12.55	.429 10.97	.272 6.91
50 (5)	2.064 52.43	.423 10.74	2.406 61.11	2.635 66.93	.605 15.37	.429 10.97	.333 8.46

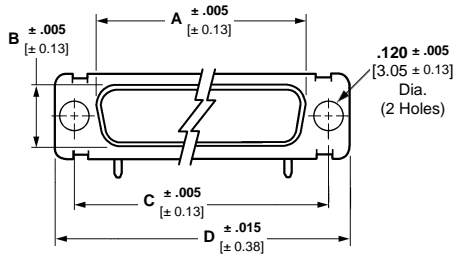

Receptacle Assemblies — .030 [0.76] Post Dia.

Shell Size	No. Pos.	Post Ext. ± .020 [± 0.51]	Military Part No. M24308/	AMP Part No.
1	9	.125 3.18	23-25F	1218434-1
2	15	.125 3.18	23-26F	1218434-2
3	25	.125 3.18	23-27F	1218434-3
4	37	.125 3.18	23-28F	1218434-4
5	50	.125 3.18	23-29F	1218434-5
1	9	.156 3.96	23-31F	1218408-1
2	15	.156 3.96	23-32F	1218408-2
3	25	.156 3.96	23-33F	1218408-3
4	37	.156 3.96	23-34F	1218408-4
5	50	.156 3.96	23-35F	1218408-5
1	9	.188 4.78	23-49F	1218437-1
2	15	.188 4.78	23-50F	1218437-2
3	25	.188 4.78	23-51F	1218437-3
4	37	.188 4.78	23-52F	1218437-4
5	50	.188 4.78	23-53F	1218437-5

Receptacle Assemblies — .040 [1.02] Post Dia.

Shell Size	No. Pos.	Post Ext. ± .020 [± 0.51]	Military Part No. M24308/	AMP Part No.
1	9	.125 3.18	23-37F	1218435-1
2	15	.125 3.18	23-38F	1218435-2
3	25	.125 3.18	23-39F	1218435-3
4	37	.125 3.18	23-40F	1218435-4
5	50	.125 3.18	23-41F	1218435-5
1	9	.156 3.96	23-43F	1218436-1
2	15	.156 3.96	23-44F	1218436-2
3	25	.156 3.96	23-45F	1218436-3
4	37	.156 3.96	23-46F	1218436-4
5	50	.156 3.96	23-47F	1218436-5
1	9	.188 4.78	23-55F	1218438-1
2	15	.188 4.78	23-56F	1218438-2
3	25	.188 4.78	23-57F	1218438-3
4	37	.188 4.78	23-58F	1218438-4
5	50	.188 4.78	23-59F	1218438-5

Note: The suffix "F" on M24308 part numbers designates cadmium shell plating.

Right-Angle, PCB Plugs, Series 109, Standard Density Connectors (Industrial Grade)

Material and Finish:

Shell — Steel, see below

Insert and Post Spacer — Approved material per MIL-DTL-24308

Contact — Copper alloy with .000050 [0.00127] min. gold plate over .000050 [0.00127] min. nickel underplate

Related Product Data:

Cavity Identification — page 5101

Mounting, Mating Specifications — page 5143

Accessories — pages 5148-5150

PCB Layouts — See page 5144 or AMP customer drawing.

Product Specification — 108-1770

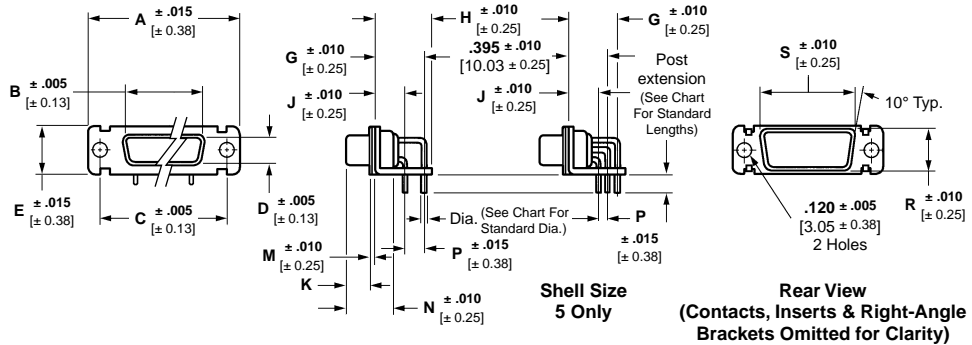

MS Shell Size	Connector Style	Dimensions													
		A	B	C	D	E	G	H	J	K	M	N	P	R	S
1	Plug	1.213	.666	.984	.329	.494	.395	.484	.283	.238/.229	.030	.422	.112	.422	.759
		30.81	16.92	24.99	8.36	12.55	10.03	12.29	7.19	6.04/5.81	0.76	10.72	2.84	10.72	19.28
2	Plug	1.541	.994	1.312	.329	.494	.395	.484	.283	.238/.229	.030	.422	.112	.422	1.083
		39.14	25.25	33.33	8.36	12.55	10.03	12.29	7.19	6.04/5.81	0.76	10.72	2.84	10.72	27.51
3	Plug	2.088	1.534	1.852	.329	.494	.395	.484	.283	.236/.224	.039	.426	.112	.422	1.625
		53.04	38.96	47.04	8.36	12.55	10.03	12.29	7.19	5.99/5.68	0.99	10.82	2.84	10.72	29.59
4	Plug	2.729	2.182	2.500	.329	.494	.395	.484	.283	.236/.224	.039	.426	.112	.422	2.272
		69.32	55.42	63.5	8.36	12.55	10.03	12.29	7.19	5.99/5.68	0.99	10.82	2.84	10.72	57.71
5	Plug	2.635	2.079	2.406	.441	.605	.507	.594	.283	.236/.224	.039	.426	.112	.534	2.178
		66.93	52.81	61.11	10.44	15.37	12.88	15.09	7.19	5.99/5.68	0.99	10.82	2.84	13.56	55.32

Plug Assemblies — .030 [0.76] Post Dia.

Shell Size	No. Pos.	Post Ext. ±.020 [± 0.51]	Part No.	
			Tin Plated Shells	Zinc Plated Shells
1	9	.125 3.18	1218830-1	1218831-1
2	15	.125 3.18	1218830-2	1218831-2
3	25	.125 3.18	1218830-3	1218831-3
4	37	.125 3.18	1218830-4	1218831-4
5	50	.125 3.18	1218830-5	1218831-5
1	9	.156 3.96	1218832-1	1218833-1
2	15	.156 3.96	1218832-2	1218833-2
3	25	.156 3.96	1218832-3	1218833-3
4	37	.156 3.96	1218832-4	1218833-4
5	50	.156 3.96	1218832-5	1218833-5
1	9	.188 4.78	1218838-1	1218839-1
2	15	.188 4.78	1218838-2	1218839-2
3	25	.188 4.78	1218838-3	1218839-3
4	37	.188 4.78	1218838-4	1218839-4
5	50	.188 4.78	1218838-5	1218839-5

Plug Assemblies — .040 [1.02] Post Dia.

Shell Size	No. Pos.	Post Ext. ±.020 [± 0.51]	Part No.	
			Tin Plated Shells	Zinc Plated Shells
1	9	.125 3.18	1218834-1	1218835-1
2	15	.125 3.18	1218834-2	1218835-2
3	25	.125 3.18	1218834-3	1218835-3
4	37	.125 3.18	1218834-4	1218835-4
5	50	.125 3.18	1218834-5	1218835-5
1	9	.156 3.96	1218836-1	1218837-1
2	15	.156 3.96	1218836-2	1218837-2
3	25	.156 3.96	1218836-3	1218837-3
4	37	.156 3.96	1218836-4	1218837-4
5	50	.156 3.96	1218836-5	1218837-5
1	9	.188 4.78	1218840-1	1218841-1
2	15	.188 4.78	1218840-2	1218841-2
3	25	.188 4.78	1218840-3	1218841-3
4	37	.188 4.78	1218840-4	1218841-4
5	50	.188 4.78	1218840-5	1218841-5

Right-Angle, PCB Receptacles, Series 109, Standard Density Connectors (Industrial Grade)

Material and Finish:

Shell — Steel, see following page for finish options

Insert and Post Spacer — Approved material per MIL-DTL-24308

Contacts —

Socket Body — Copper alloy with .000050 [0.00127] min. gold plate over .000050 [0.00127] min. nickel underplate

^a**Mating Area** — Copper alloy with .000050 [0.00127] min. gold plate over .000050 [0.00127] min. nickel underplate

^b**Mating Area** — Copper alloy with .000030 [0.00076] min. gold plate over .000050 [0.00127] min. nickel underplate

Related Product Data:

Cavity Identification — page 5101

Mounting, Mating Specifications — page 5143

Accessories — pages 5148-5150

PCB Layouts — See page 5144 or AMP customer drawing.

Product Specification — 108-1770

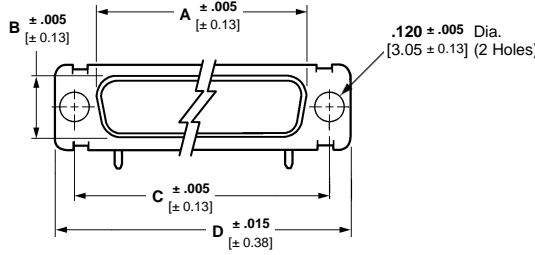

9, 15, 25 and 37 Positions

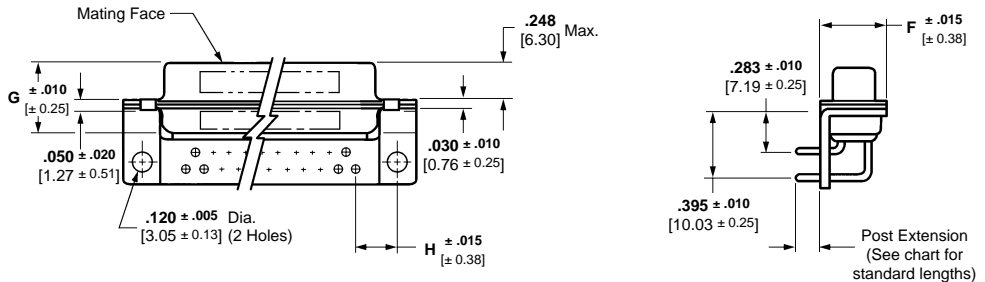

50 Positions

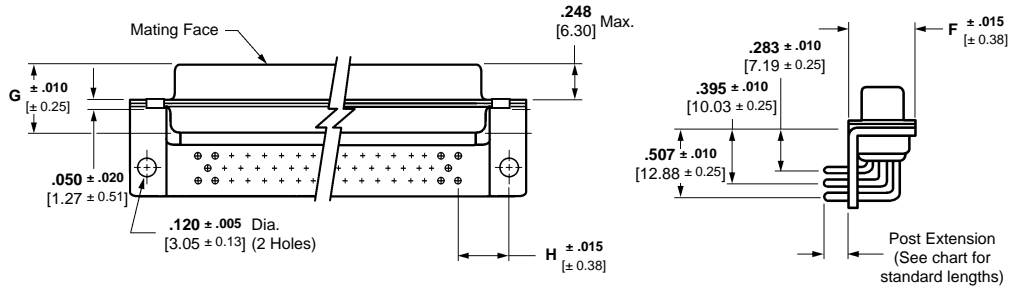

Receptacle Assemblies

No. of Contact Pos. (Shell Size)	Dimensions						
	A (Outside)	B (Outside)	C	D	F	G	H
9 (1)	.643 16.33	.311 7.9	.984 24.99	1.213 30.81	.494 12.55	.429 10.97	.276 7.01
15 (2)	.971 24.66	.311 7.9	1.312 33.32	1.541 39.14	.494 12.55	.429 10.97	.278 7.06
25 (3)	1.511 38.38	.311 7.9	1.852 47.04	2.088 53.04	.494 12.55	.429 10.97	.274 6.96
37 (4)	2.159 54.84	.311 7.9	2.500 63.5	2.729 69.32	.494 12.55	.429 10.97	.272 6.91
50 (5)	2.064 52.43	.423 10.74	2.406 61.11	2.635 66.93	.605 15.37	.429 10.97	.333 8.46

Right-Angle, PCB Receptacles, Series 109, Standard Density Connectors
(Industrial Grade) (Continued)

Material and Finish:

Shell — Steel
Insert and Post Spacer — Approved material per MIL-DTL-24308

Contacts —
Socket Body — Copper alloy with .000050 [0.00127] min. gold plate over .000050 [0.00127] min. nickel underplate

^aMating Area — Copper alloy with .000050 [0.00127] min. gold plate over .000050 [0.00127] min. nickel underplate

^bMating Area — Copper alloy with .000030 [0.00076] min. gold plate over .000050 [0.00127] min. nickel underplate

Related Product Data:

Cavity Identification — page 5101
Mounting, Mating Specifications — page 5143
Accessories — pages 5148-5150
PCB Layouts — See page 5144 or AMP customer drawing.
Product Specification — 108-1770

Receptacle Assemblies — .030 [0.76] Post Dia.

Shell Size	No. Pos.	Post Ext. ± .020 [± 0.51]	Part No.		
			Tin Plated Shells ^a	Tin Plated Shells ^a	Zinc Plated Shells ^a
1	9	.125 3.18	1218842-1	1218844-1	1218843-1
2	15	.125 3.18	1218842-2	1218844-2	1218843-2
3	25	.125 3.18	1218842-3	1218844-3	1218843-3
4	37	.125 3.18	1218842-4	1218844-4	1218843-4
5	50	.125 3.18	1218842-5	1218844-5	1218843-5
1	9	.156 3.96	1218845-1	1218847-1	1218846-1
2	15	.156 3.96	1218845-2	1218847-2	1218846-2
3	25	.156 3.96	1218845-3	1218847-3	1218846-3
4	37	.156 3.96	1218845-4	1218847-4	1218846-4
5	50	.156 3.96	1218845-5	1218847-5	1218846-5
1	9	.188 4.78	1218854-1	1218856-1	1218855-1
2	15	.188 4.78	1218854-2	1218856-2	1218855-2
3	25	.188 4.78	1218854-3	1218856-3	1218855-3
4	37	.188 4.78	1218854-4	1218856-4	1218855-4
5	50	.188 4.78	1218854-5	1218856-5	1218855-5

Receptacle Assemblies — .040 [1.02] Post Dia.

Shell Size	No. Pos.	Post Ext. ± .020 [± 0.51]	Part No.		
			Tin Plated Shells ^a	Tin Plated Shells ^a	Zinc Plated Shells ^a
1	9	.125 3.18	1218848-1	1218850-1	1218849-1
2	15	.125 3.18	1218848-2	1218850-2	1218849-2
3	25	.125 3.18	1218848-3	1218850-3	1218849-3
4	37	.125 3.18	1218848-4	1218850-4	1218849-4
5	50	.125 3.18	1218848-5	1218850-5	1218849-5
1	9	.156 3.96	1218851-1	1218853-1	1218852-1
2	15	.156 3.96	1218851-2	1218853-2	1218852-2
3	25	.156 3.96	1218851-3	1218853-3	1218852-3
4	37	.156 3.96	1218851-4	1218853-4	1218852-4
5	50	.156 3.96	1218851-5	1218853-5	1218852-5
1	9	.188 4.78	1218857-1	1218859-1	1218858-1
2	15	.188 4.78	1218857-2	1218859-2	1218858-2
3	25	.188 4.78	1218857-3	1218859-3	1218858-3
4	37	.188 4.78	1218857-4	1218859-4	1218858-4
5	50	.188 4.78	1218857-5	1218859-5	1218858-5

5 Pin and Socket Connectors

Electronics

Right-Angle, PCB Plugs, Series 109, with One Piece Insert
(Industrial Grade)

Material and Finish:
Shell — Steel, see below
Insert — Thermoplastic
Contact Material — Brass or Beryllium copper
Contact Finish — Gold with .000010 [0.00025] min. gold plate over .000050 [0.00127] min. nickel underplate
Interfacial Seal — Fluorosilicone

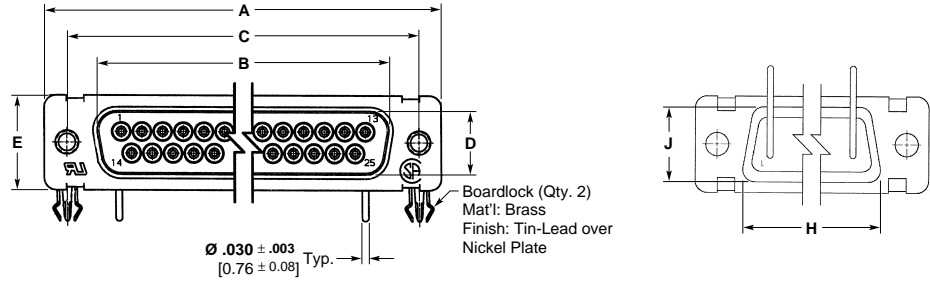

3 and 5 Positions (with interfacial seal)

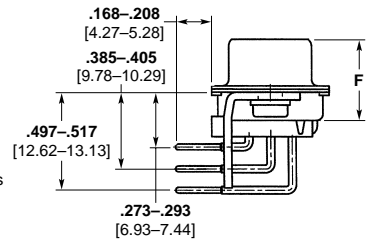
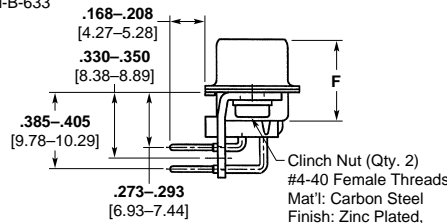
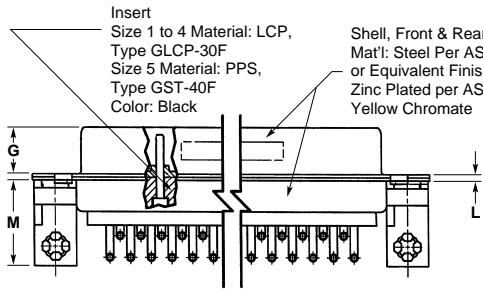

9 Position (with Locking Post)

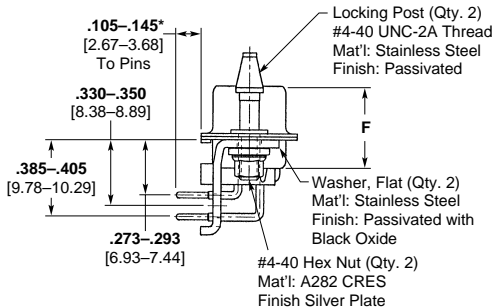
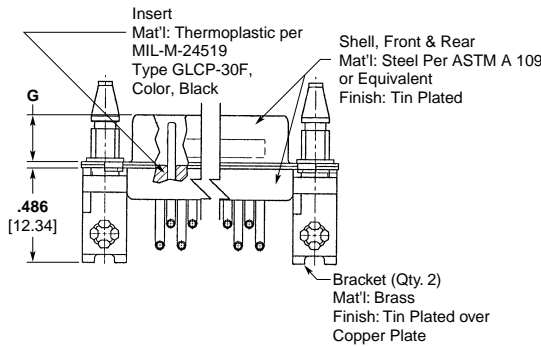
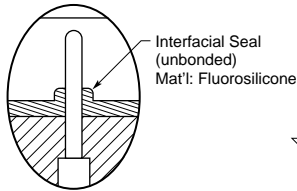

*Signal Contacts are solder dipped with SnPb 63/37 to meet the requirements of MIL-DTL-24308, method 208.

MS Shell Size	Connector Style	Dimensions										
		A	B	C	D	E	F	G	H	J	L	M
1	Plug	1.198/1.228 30.43/31.19	.661/1.671 16.21/16.46	.979/1.989 24.87/25.12	.324/1.334 8.23/8.48	.479/1.509 12.17/12.93	.412/1.432 10.46/10.97	.229/1.238 5.82/6.05	.749/1.769 19.02/19.53	.412/1.432 10.46/10.97	.020/0.040 0.51/1.02	—
3	Plug	2.073/2.103 52.65/53.42	1.529/1.539 38.25/38.51	1.847/1.857 46.91/47.17	.324/1.334 8.23/8.48	.479/1.509 12.17/12.93	.416/1.436 10.57/11.07	.224/1.236 5.69/5.99	1.615/1.635 41.02/41.53	.412/1.432 10.46/10.97	.029/0.049 0.74/1.24	.435/1.443 11.05/11.25
5	Plug	2.620/2.650 66.55/67.31	2.074/2.084 52.30/52.55	2.401/2.411 60.99/61.24	.436/1.446 11.07/11.33	.590/1.620 14.99/15.75	.416/1.436 10.57/11.07	.224/1.236 5.69/5.99	2.168/2.188 55.07/55.58	.524/1.544 13.31/13.82	.029/0.049 0.74/1.24	.490/1.498 12.45/12.65

Plug Assemblies — .030 [0.76] Post Dia.

Shell Size	No. Pos.	With interfacial Seal	Part No.	
			Tin Plated Shells	Zinc Plated Shells
1	9	No	1218606-6	—
3	25	Yes	—	1218538-3
5	50	Yes	—	1218538-5

Right-Angle, PCB Receptacles, Series 109, with One Piece Insert
(Industrial Grade)

Material and Finish:

Shell — Steel, tin plated

Insert — Thermoplastic

Contact Material — Brass or Beryllium copper

Contact Finish — Gold with .000010 [0.00025] min. gold over .000050 [0.00127] min. nickel underplate

9 Position

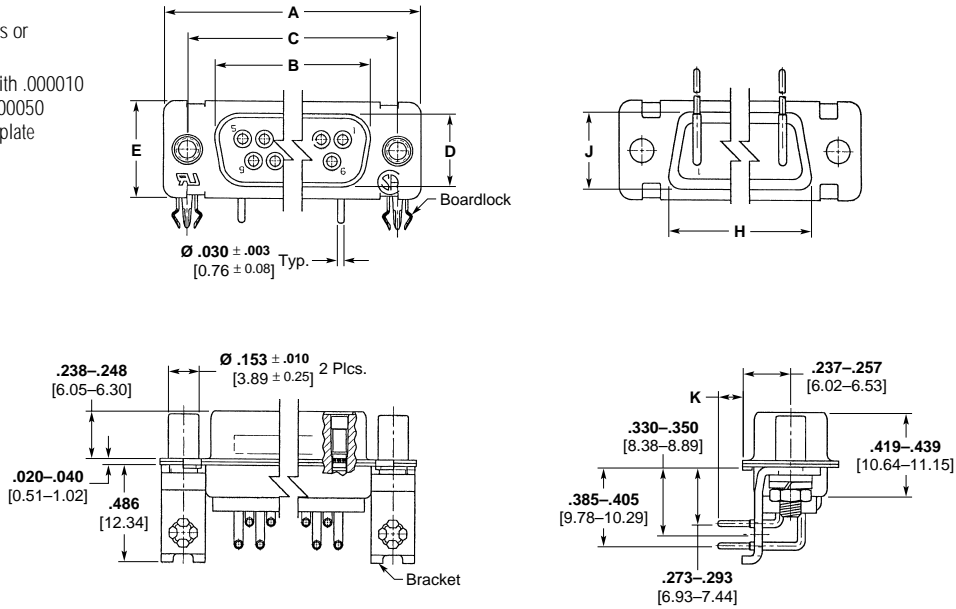

9 Position (with Locking Post)

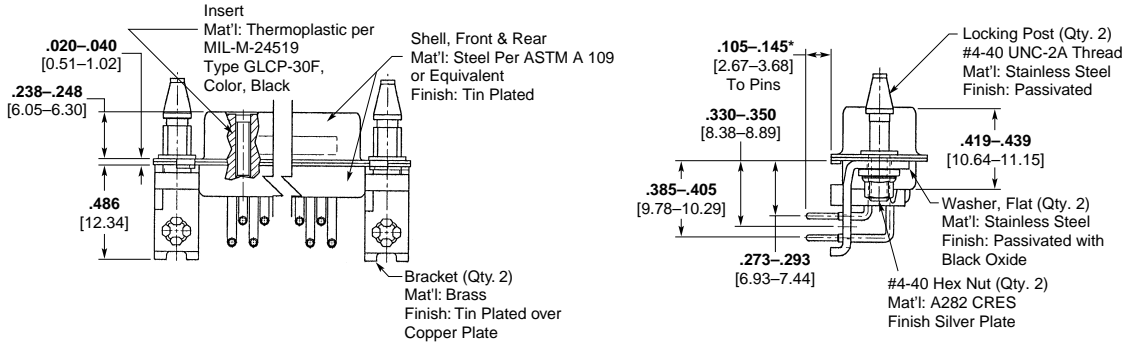

*Signal Contacts are solder dipped with SnPb 63/37 to meet the requirements of MIL-DTL-24308, method 208.

MS Shell Size	Connector Style	Dimensions					H	J	K	Part Number
		A	B	C	D	E				
1	Receptacle	1.198/1.228	.638/.648	.979/.989	.306/.316	.479/.509	.749/.769	.412/.432	.105/.145	1218665-1
		30.43/31.19	16.21/16.46	24.87/25.12	7.77/8.03	12.17/12.93	19.02/19.53	10.46/10.97	2.67/3.68	1218665-6
							.749/.769	.412/.432	—	1218607-6
						19.02/19.53	10.46/10.97			

Solder Cup, Series 109, Standard Density Connectors

Material and Finish:
Shell — Steel or brass, cadmium plated
Insert — Approved material per MIL-DTL-24308
Contact — Copper alloy, plated gold over copper underplate

Related Product Data:
Cavity Identification — page 5101
Mounting, Mating Specifications — page 5143
Accessories — pages 5148-5150

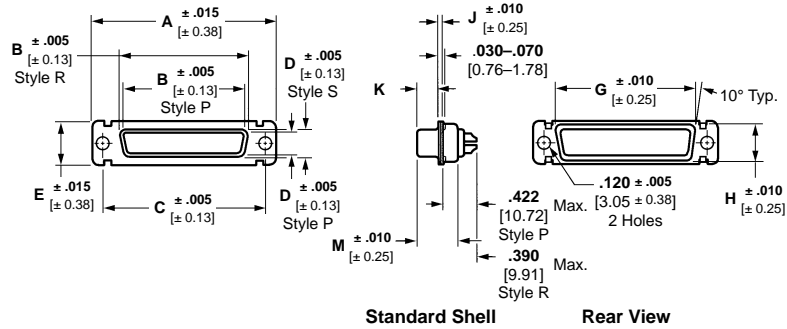

MS Shell Size	Connector Style	Dimensions									
		A	B	C	D	E	G	H	J	K	M
1	Plug	1.213 [30.81]	.666 [16.92]	.984 [24.99]	.329 [8.36]	.494 [12.55]	.759 [19.28]	.422 [10.72]	.030 [0.76]	.238/.229 [6.09/5.81]	.422 [10.72]
	Receptacle	1.213 [30.81]	.643 [16.33]	.984 [24.99]	.311 [7.90]	.494 [12.55]	.759 [19.28]	.422 [10.72]	.030 [0.76]	.248/.238 [6.29/6.09]	.429 [10.90]
2	Plug	1.541 [39.14]	.994 [25.25]	1.312 [33.32]	.329 [8.36]	.494 [12.55]	1.083 [27.51]	.422 [10.72]	.030 [0.76]	.238/.229 [6.09/5.81]	.422 [10.72]
	Receptacle	1.541 [39.14]	.971 [24.66]	1.312 [33.32]	.311 [7.90]	.494 [12.55]	1.083 [27.51]	.422 [10.72]	.030 [0.76]	.248/.238 [6.29/6.09]	.429 [10.90]
3	Plug	2.088 [53.04]	1.534 [38.96]	1.852 [47.04]	.329 [8.36]	.494 [12.55]	1.625 [41.28]	.422 [10.72]	.039 [0.99]	.236/.224 [5.99/5.68]	.426 [10.82]
	Receptacle	2.088 [53.04]	1.511 [38.38]	1.852 [47.04]	.311 [7.90]	.494 [12.55]	1.625 [41.28]	.422 [10.72]	.030 [0.76]	.248/.238 [6.29/6.09]	.429 [10.90]
4	Plug	2.729 [69.32]	2.182 [55.42]	2.500 [63.5]	.329 [8.36]	.494 [12.55]	2.272 [57.71]	.422 [10.72]	.039 [0.99]	.236/.224 [5.99/5.68]	.426 [10.82]
	Receptacle	2.729 [69.32]	2.159 [54.84]	2.500 [63.5]	.311 [7.90]	.494 [12.55]	2.272 [57.71]	.422 [10.72]	.030 [0.76]	.248/.238 [6.29/6.09]	.429 [10.90]
5	Plug	2.635 [66.93]	2.079 [52.81]	2.406 [61.11]	.441 [11.20]	.605 [15.37]	2.178 [55.32]	.534 [13.56]	.039 [0.99]	.236/.224 [5.99/5.68]	.426 [10.82]
	Receptacle	2.635 [66.93]	2.064 [52.43]	2.406 [61.11]	.423 [10.74]	.605 [15.37]	2.178 [55.32]	.534 [13.56]	.030 [0.76]	.248/.238 [6.29/6.09]	.429 [10.90]

Solder Cup Assemblies

Steel Shells

Contact Style	Shell Size	No. Pos.	Mount	Military Part No. M24308/	AMP Part No.
Receptacle	1	9	Std.	1-1F	593007-1
	2	15	Std.	1-2F	593007-2
	3	25	Std.	1-3F	593007-3
	4	37	Std.	1-4F	593007-4
	5	50	Std.	1-5F	593007-5
Receptacle	1	9	F/F	1-12F	593008-1
	2	15	F/F	1-13F	593008-2
	3	25	F/F	1-14F	593008-3
	4	37	F/F	1-15F	593008-4
	5	50	F/F	1-16F	593008-5
Receptacle	1	9	D/F	1-23F	593009-1
	2	15	D/F	1-24F	593009-2
	3	25	D/F	1-25F	593009-3
	4	37	D/F	1-26F	593009-4
	5	50	D/F	1-27F	593009-5
Plug	1	9	Std.	3-1F	593002-1
	2	15	Std.	3-2F	593002-2
	3	25	Std.	3-3F	593002-3
	4	37	Std.	3-4F	593002-4
	5	50	Std.	3-5F	593002-5
Plug	1	9	F/F	3-12F	593004-1
	2	15	F/F	3-13F	593004-2
	3	25	F/F	3-14F	593004-3
	4	37	F/F	3-15F	593004-4
	5	50	F/F	3-16F	593004-5

Brass Shells (Non-Magnetic)

Contact Style	Shell Size	No. Pos.	Mount	Military Part No. M24308/	AMP Part No.
Receptacle	1	9	Std.	5-1F	593036-1
	2	15	Std.	5-2F	593036-2
	3	25	Std.	5-3F	593036-3
	4	37	Std.	5-4F	593036-4
	5	50	Std.	5-5F	593036-5
Receptacle	1	9	F/F	5-12F	593037-1
	2	15	F/F	5-13F	593037-2
	3	25	F/F	5-14F	593037-3
	4	37	F/F	5-15F	593037-4
	5	50	F/F	5-16F	593037-5
Receptacle	1	9	D/F	5-23F	593038-1
	2	15	D/F	5-24F	593038-2
	3	25	D/F	5-25F	593038-3
	4	37	D/F	5-26F	593038-4
	5	50	D/F	5-27F	593038-5
Plug	1	9	Std.	7-1F	593057-1
	2	15	Std.	7-2F	593057-2
	3	25	Std.	7-3F	593057-3
	4	37	Std.	7-4F	593057-4
	5	50	Std.	7-5F	593057-5
Plug	1	9	F/F	7-12F	593058-1
	2	15	F/F	7-13F	593058-2
	3	25	F/F	7-14F	593058-3
	4	37	F/F	7-15F	593058-4
	5	50	F/F	7-16F	593058-5

Mounting Abbreviations: Std. = Standard, F/F = Front Float, D/F - Dual Float
Note: The suffix "F" on M24308 part numbers designates cadmium shell plating.

Connector Savers, Series 109, Standard Density

Connector savers prolong the life of permanently installed connectors which would otherwise be subjected to repeated cycles of mating and unmating, in applications such as test interfaces or on testing devices.

Material and Finish:

Standard —

- Shell** — Steel, cadmium plated
- Contact Body** — Beryllium copper with .000050 [0.00127] min. gold plate over .000050 [0.00127] min. nickel underplate
- Socket Hood** — Passivated stainless steel
- Insert** — Glass filled polyester
- Spacer** — Black nylon

Non Magnetic —

- Shell** — Brass, gold plated
- Contact Body** — Beryllium copper with .000050 [0.00127] min. gold plate over .000100 [0.00254] min. copper underplate
- Socket Hood** — Brass with .000050 [0.00127] min. gold over .000100 [0.00254] min. copper underplate
- Insert** — Glass filled polyester
- Spacer** — Black nylon

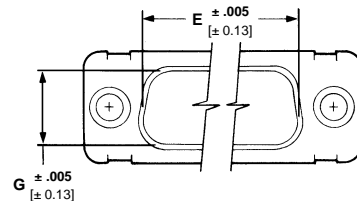
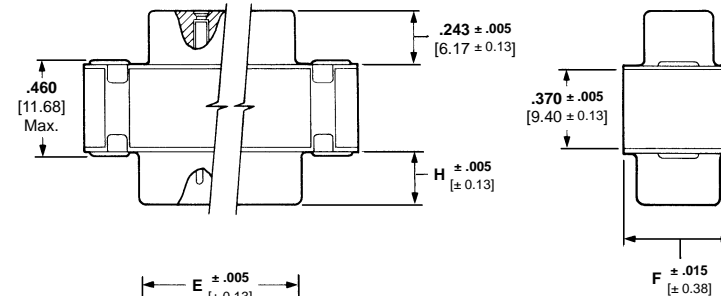
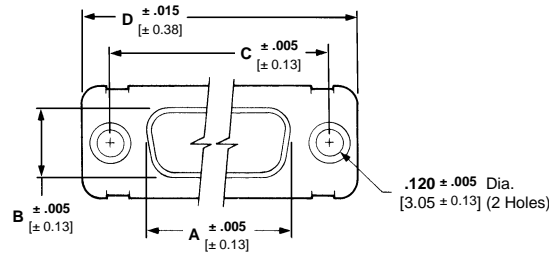

No. of Contact Pos. (Shell Size)	Dimensions							
	A (outside)	B (outside)	C	D	E (inside)	F	G (inside)	H
9 (1)	.643 16.33	.311 7.9	.984 24.99	1.213 30.81	.666 16.92	.494 12.55	.329 8.36	.235 5.97
15 (2)	.971 24.66	.311 7.9	1.312 33.32	1.541 39.14	.994 25.25	.494 12.55	.329 8.36	.235 5.97
25 (3)	1.511 38.38	.311 7.9	1.852 47.04	2.088 53.04	1.534 38.96	.494 12.55	.329 8.36	.230 5.84
37 (4)	2.159 54.84	.311 7.9	2.500 63.5	2.729 69.32	2.182 55.42	.494 12.55	.329 8.36	.230 5.84
50 (5)	2.064 52.43	.423 10.74	2.406 61.11	2.635 66.93	2.079 52.81	.605 15.37	.441 11.20	.230 5.84

No. of Contact Pos. (Shell Size)	Standard (Cadmium Plated Steel Shell)	Non-Magnetic (Gold Plated Brass Shell)
9 (1)	212559-1	212559-2
15 (2)	212560-1	212560-2
25 (3)	212561-1	212561-2
37 (4)	212562-1	212562-2
50 (5)	212563-1	212563-2

Crimp, Power/Coax/Signal Combination Standard Density, Series 109 Connectors

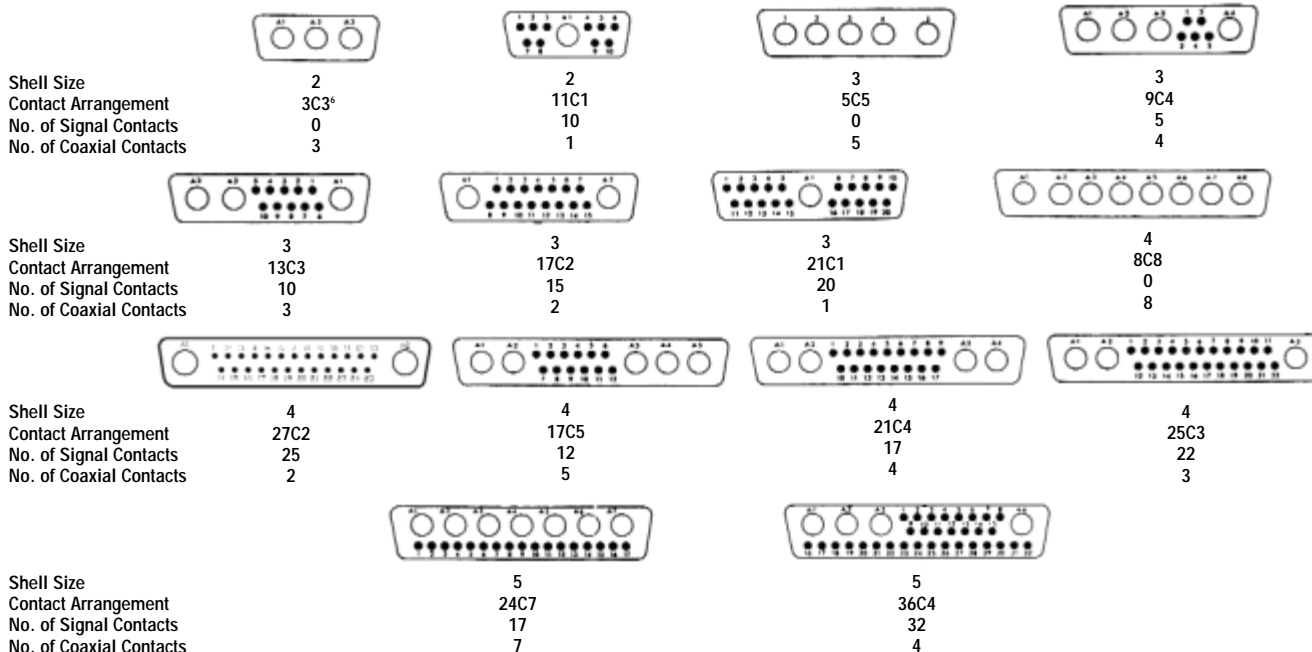

Material and Finish:

- Shell** — Steel or copper alloy
- Plating** — Cadmium, tin or gold
- Insert** — Approved material per MIL-DTL-24308
- Retention Clips** — Stainless steel or copper alloy

Contact Selection:

- Standard:**
 - Size 8 coax: Table I, page 5125
 - Size 8 power: page 5124
 - Size 20 signal: pages 5102-5104, 5107 and 5108
- Blindmate:**
 - Size 8 coax: Table II, page 5126
 - Size 8 power: page 5124
 - Size 20 signal: pages 5102-5104, 5107 and 5108

Insert Arrangement	Standard								Blindmate	
	Cad Plated Steel Shell (.120 Mounting Hole)		Tin Plated Steel Shell (.120 Mounting Hole)		NASA Gold Plated Brass (.120 Mounting Hole)		NASA Gold Plated Brass (.154 Mounting Hole)		Cad Plated Steel Shell (.120 Mounting Hole)	
	Plug (Pin)	Receptacle (Socket)	Plug (Pin)	Receptacle (Socket)	Plug (Pin)	Receptacle (Socket)	Plug (Pin)	Receptacle (Socket)	Plug (Pin)	Receptacle (Socket)
3C3	448153-1	445705-4	448153-4	445705-1	448153-2	445705-2	448153-3	445705-3	447717-1	447718-1
11C1	211111-1	211112-1	211111-4	211112-4	211111-2	211112-2	211111-3	211112-3	447721-1	447722-1
5C5	212491-1	212059-1	212491-3	212059-3	212491-6	212059-2	212491-7	212059-6	446630-1	212049-3
9C4	212498-1	212502-1	212498-4	212502-5	212498-2	212502-2	212498-3	212502-3	445701-1	212051-2
13C3	208810-1	208811-1	208810-2	208811-2	208810-3	208811-3	208810-4	208811-4	447723-1	212057-2
17C2	212506-1	212510-1	212506-5	212510-4	212506-2	212510-2	212506-4	212510-3	447724-1	212053-3
21C1	212522-1	212526-1	212522-2	212526-2	212522-3	212526-3	212522-4	212526-4	447727-1	212055-2
8C8	446405-1	445730-1	446405-4	445730-5	446405-2	445730-3	446405-3	445730-4	447719-1	447720-1
27C2	212538-1	212542-1	212538-4	212542-4	212538-2	212542-2	212538-3	212542-3	447732-1	447733-1
17C5	212514-1	212518-1	212514-5	212518-5	212514-3	212518-3	212514-4	212518-4	447725-1	447726-1
21C4	212530-1	212534-1	212530-4	212534-4	212530-2	212534-2	212530-3	212534-3	447728-1	447726-1
25C3	208742-1	208551-1	208742-4	208551-4	208742-2	208551-2	208742-3	208551-3	447730-1	447731-1
24C7	208743-1	208552-1	208743-4	208552-4	208743-2	208552-2	208743-6	208552-5	446631-1	445000-2
36C4	208744-1	208550-1	208744-5	208550-4	208744-3	208550-2	208744-4	208550-3	446710-1	446711-1

Notes:

- NASA connectors listed above are qualified to NASA specification 311-P-405. See pages 5156 and 5157 for NASA cross reference.
- Plug insert arrangements shown. Receptacle arrangement is mirror image.
- Cable clamp/strain relief hardware cannot be used with these arrangements.
- See pages 5146 and 5147 for PCB layouts.
- Blindmate plugs feature a chamfered lead-in on the front shell, which is constructed of aluminum alloy. See page 5109 for shell dimensions. Blindmate receptacles feature float bushings installed in the mounting holes. See pages 5105 and 5106 for shell dimensions.
- The 3C3 arrangement can be mated 180°. Contact Tyco Electronics or call Technical Support for keyed Part Numbers.
- All connector plugs with grounding indents except the cadmium plated.

Boardmount Power/Coax/Signal/Combination Standard Density, Series 109 Connectors

Shell Size	2	2	3	4
Contact Arrangement	3C3 ¹	11C1	13C3	17C5
No. of Signal Contacts	0	10	10	12
No. of Coaxial Contacts	3	1	3	5
Shell Size	4	4	5	
Contact Arrangement	21C4	25C3	36C4	
No. of Signal Contacts	17	22	32	
No. of Coaxial Contacts	4	3	4	

Material and Finish:

Shell — Steel or copper alloy

Plating — Cadmium or tin

Insert — Approved material per MIL-DTL-24308

Contact Selection:

Standard (If not shown with connector):

Size 8 coax: Table I, page 5125

Size 8 power: page 5124

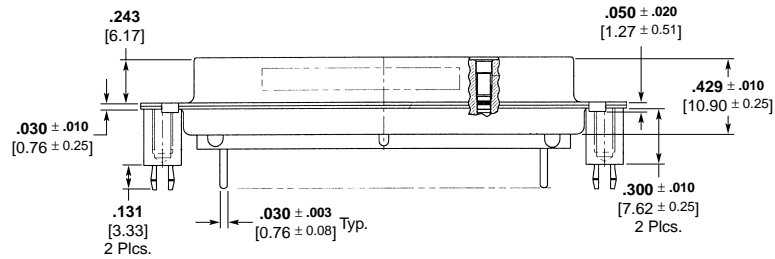

Typical Vertical Receptacle

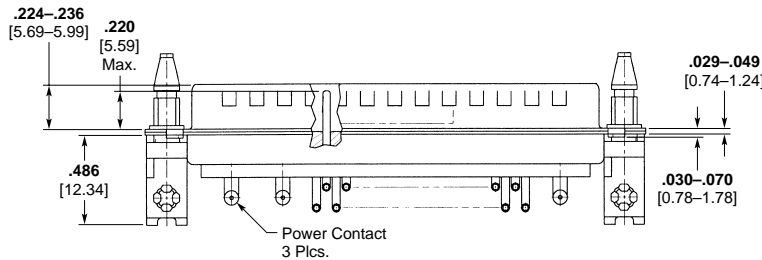

Typical Right-Angle Plug

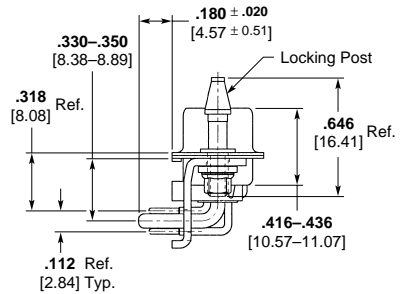

Contact Config.	Shell Plating	Style	Hardware Options		4-40 Standoff			Contacts		Spacers	Part No.
			Screwlocks	Boardlocks	Clinchnuts	w/ Boardlocks	Locking Posts	Power	Coax		
3C3	Tin	Vertical Recept.	No	No	No	Yes	No	No	No	No	1218896-1
11C1	Cad.	Vertical Plug	No	No	No	No	No	No	Yes	Yes	1218128-1
11C1	Cad.	Vertical Recept.	No	No	No	No	No	No	Yes	Yes	1218129-1
13C3	Tin	Vertical Plug	No	No	No	Yes	No	No	No	No	1218816-1
17C5	Tin	Right-Angle Plug	Yes	Yes	No	No	No	Yes	No	No	1218939-1
21C4	Tin	Vertical Recept.	No	No	No	Yes	No	No	No	No	1218887-1
25C3	Tin	Right-Angle Plug	No	Yes	No	No	Yes	Yes	No	No	1218611-1
36C4	Tin	Vertical Recept.	No	Yes	No	Yes	No	No	No	No	1218807-1

Notes:

1. Plug insert arrangements shown. Receptacle arrangement is mirror image.
2. See AMP customer drawing for PCB layouts.
3. The 3C3 arrangement can be mated 180°. Contact your Tyco Electronics Sales Engineer or call Technical Support for keyed Part Numbers.

Size 8 Contacts (Power) for Standard Density,
Series 109 Power/Coax/Signal Connectors

Crimp Contacts

Material and Finish:

Copper alloy, plated gold over nickel underplate

Retention Clips — Stainless steel or phosphor bronze

Note: clip may differ from view shown

Product Specification:

For Crimp Contacts — 108-10045
(current rating and wire size)

For PCB Contacts — 108-10045-1

Hand Crimp Tool — AMP 608651-1
with positioner AMP 608651-2

Extraction Tool — 318813-1

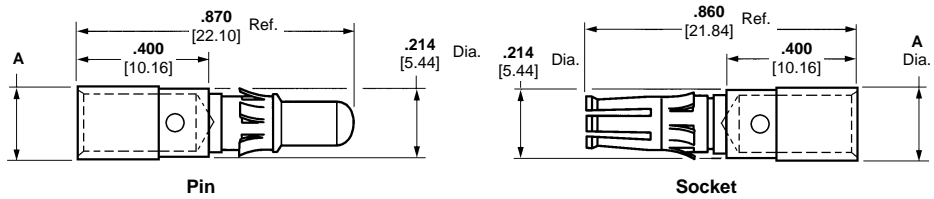

Wire Size Range		Dim. A	Part Numbers					
AWG	mm ²		50 Gold Pins ³	30 Gold Pins ³	50 Gold Sockets	30 Gold Sockets	Blindmate 50 Gold Pins	30 Blindmate Gold Pins
8 ²	8	.230 5.84	211159-1	211159-3	211161-1	211161-3	1218385-1	—
10 ²	5	.185 4.69	211159-2	211159-4	211161-2	211161-4	—	—
12-14	2-3	.150 3.81	212007-1	212007-2	212008-1	212008-2	1218483-1	1218483-2
16-18	0.8-1.4	.102 2.59	212013-1 ¹	212013-2 ¹	212014-1 ¹	212014-2 ¹	—	—

- Notes:** 1. 16-18 size use 608668-1 with Positioner 608668-2.
2. Retention clip shown is for 12-14, 16-18 Awg. See AMP customer drawing for 8, 10 AWG Retention Clip.
3. Use these contacts only with the **Standard** connectors on pages 5122 and 5123. Do not use with **Blindmate** connectors.

Printed Circuit Board Contacts

(Use these contacts only with the **Standard** connectors on page 5123. Do not use with **Blindmate** connectors.)

Right-Angle

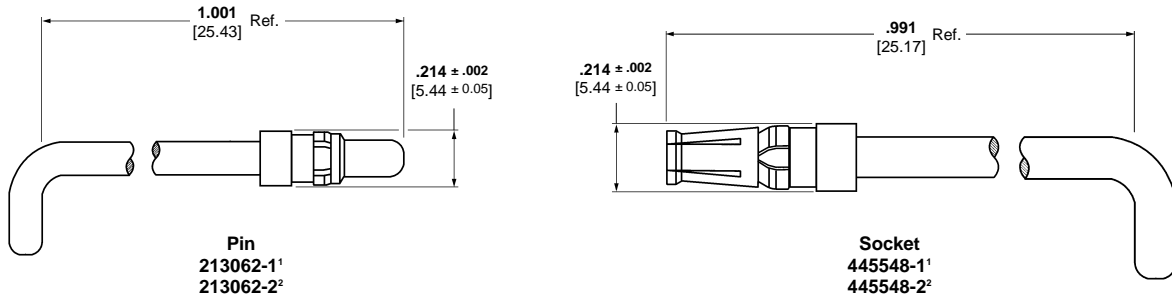

Vertical

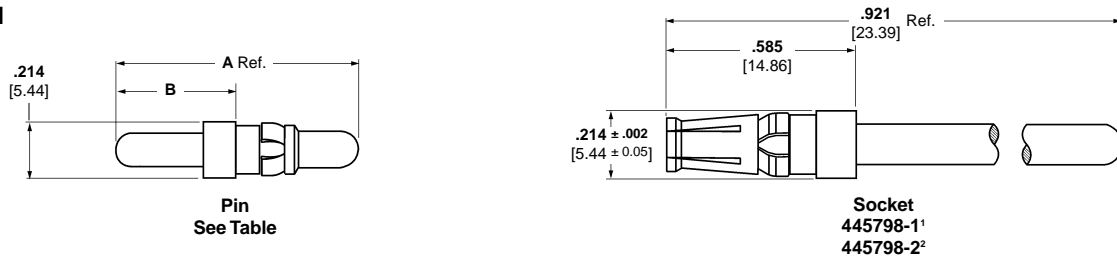

Part Number	Dim A	Dim B
449379-1 ¹	.931 [23.65]	.461 [11.71]
449379-2 ¹	.845 [21.46]	.375 [9.52]
1-449379-0 ²	.931 [23.65]	.461 [11.71]
1-449379-1 ²	.845 [21.46]	.375 [9.52]

- Note:** 1. Standard connector, .000050 [0.00127] gold plating.
2. Standard connector, .000030 [0.00076] gold plating.

RF Contacts for Standard Density, Series 109 Power/Coax/Signal Connectors

Performance Characteristics

Frequency Range — 0 to 500 MHz

Operating Voltage, Max. —
275 vac rms @ sea level

Termination Resistance, Max. —
Center Contact — 6.0 milliohms
Outer Contact — 3.0 milliohms

Insulation Resistance, Min. —
5,000 megohms @ 500 vdc

Dielectric Withstanding Voltage —
Sea Level — 800 Volts rms
30,000 ft [9,144 m] — 525 volts rms
70,000 ft [21,336m] — 275 volts rms

VSWR to 500MHz, Max.

Pin/Socket	VSWR
Straight/Straight	1.30
Right-Angle/Straight	1.35
Right-Angle/Right-Angle	1.40

Extraction Tool — 318813-1
Hand Crimp Tool — 69710-2
Pneu. Crimp Tool — 69365-8
Dies for Crimp Tools — See table
Instruction Sheet —
 408-06755 Size 8 Coaxial RF 50-Ohm
 and Non-Impedance
 Matched Pin and Socket
 Contact Kits

RF Crosstalk — 90dB @ 5-500 MHz

Mating Force, Max. — 4.0 lb
[17.8 N]

Unmating Force, Min. — 2.0 oz
[0.556 N]

Contact Retention — 20 lb [89 N]

Contact Durability — 500 cycles

Cable RG/U	Force	
	lb	[N]
316, 188, 174, 179, 179A, 179B	20	89
188-type Double-Braid	35	155.8
142, 142A, 142B	50	222.5

Operating Temperature —
131°F to 257°F [55°C to +125°C]

Thermal Shock — 131°F to 257°F
[55°C to +125°C] per MIL-STD-1344,
Method 1003, Cond. A

Physical Shock — 50 G's per MIL-
STD-1344, Method 2004, Cond. A

Vibration — MIL-STD-1344, Method
2005, Cond. II

Moisture Resistance — 240 hours
per MIL-STD-1344, Method 1002,
Cond. II

Salt Fog — 48 hours per MIL-STD-
1344, Method 1001, Cond. B

Extraction Tool Numbers

Subminiature D Housings —
58095-1 AMPLIMITE Connector

AMP-HDI Connector Housings —
58095-2

Material

Brass — per QQ-B-626 and MIL-C-50

Phosphor Bronze — per QQ-B-750

Beryllium Copper — per QQ-C-530

TEFLON — per MIL-P-19468

Nylon — per MIL-M-20693

Finish

Bright Tin-Lead Plating — per
ASTM-B-571

Copper Plating — per MIL-C-14550

Gold Plating — per MIL-G-45204

Nickel Plating — per QQ-N-290

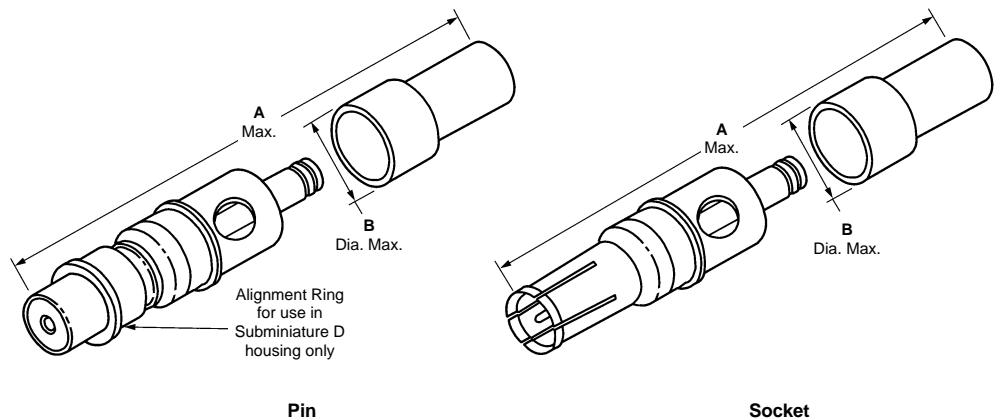

Table I - Standard

RG/U Cable	Dimensions A B		Contact Part Numbers				Die Insert for Tools
			Non-Impedance Matched		50 Ohm		
			Pin	Socket	Pin	Socket	
178, 178A, 178B 196, 196A	.950 24.13	.235 5.94	228618-5	228596-5	—	—	59993-1
174, 316 188, 188A	.956 24.28	.234 5.94	228618-1	228596-1	221980-1	221981-1	59993-1
179, 179A, 179B 187, 187A, 161 Belden 9221	.956 24.28	.234 5.94	228618-2	228596-2	221980-3	221981-3	59993-1
188-Type Double Braid	.956 24.28	.234 5.94	228618-3	228596-3	—	—	59993-1
142, 142A, 142B 400, Belden 9246	1.080 27.43	.255 6.48	228618-4	228596-4	221980-2	221981-2	58212-1

Notes:

1. Non Impedance Matched contacts and 50 ohm contacts are not intermateable.
2. Use these contacts only with the **Standard** connectors on pages 5122 and 5123.

RF Contacts for Standard Density,
Series 109 Power/Coax/Signal Connectors (Continued)

Materials

Center Contacts — Beryllium Copper or Brass per QQ-B-626, per QQ-C-530, gold plated

Outer Contacts — Beryllium copper per QQ-C-530, gold plated

Plugs — Beryllium copper per QQ-C-530, gold plated

Jack — Stainless steel per ASTM-A-582, gold plated

Shells — Stainless steel per ASTM-A-582, passivated

Panel Shells — Brass per QQ-B-626, nickel plated

Dielectrics — TEFLON per ASTM-D-1457

Grip Rings — Brass per MIL-C-50 or Beryllium Copper per QQ-C-530, nickel plated

Springs — Steel wire per QQ-W-470

Bushings — Stainless steel per ASTM-A-582, passivated

Retention Springs — Beryllium Copper per QQ-C-530, Tin-Lead Plated

Finishes

Passivate per QQ-P-35

Gold per MIL-G-45204

Nickel per QQ-N-290

Tin-Lead per ASTM-B-545

Performance Characteristics:

Electrical Characteristics

Nominal Impedance — 50 ohms

Frequency Range —

2.8 mm: 0 to 26.5 GHz

2.8 mm for size 8 cavities: 0 to 40 GHz

Operating Voltage —

RG-402/U Cable (3.58 [1.141] O.D.)

500 volts rms at 60 Hz (sea level)

125 volts rms at 60 Hz

(21 336 m [70,000 ft])

RG-405/U Cable (2.18 [.086] O.D.)

335 volts rms at 60 Hz (sea level)

85 volts rms at 60 Hz

70,000 ft [21,336 m]

Mechanical Characteristics

Cable Retention —

RG-402/U Cable (3.58 [1.141] O.D.)—

60 lb [266.9 N], min.

RG-405/U Cable (2.18 [.086] O.D.)—

30 lb [133.4 N], min.

Connector Mating Force —

2.8 mm: 3 lbs Max.

Environmental Characteristics

Temperature Range —

-85°F to +221°F [-65°C to +105°C]

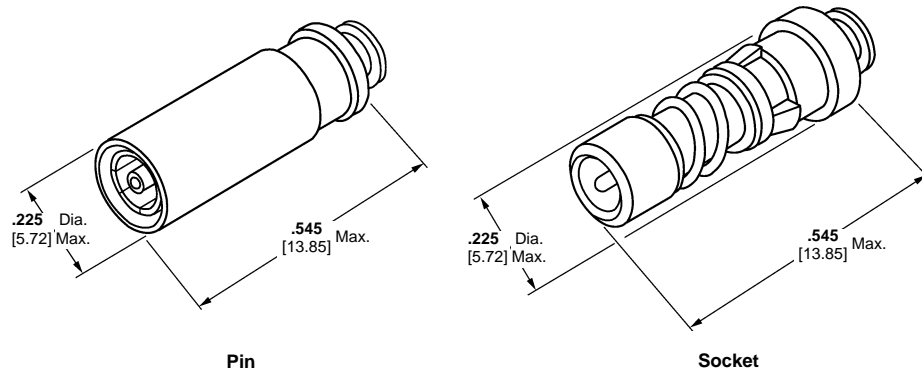

Table II - 2.8 mm Blindmate

RG/U Cable	Contact Type	Part Number	Crimp Tool	Die Set	Locator	Insertion Tool	Extraction Tool
405 Semi-Rigid .086 [2.18]	Pin (Plug)	413242-1	59980-1	312253-2	852113-1	852115-1	2-305183-0
	Socket (Jack)	413249-1	59980-1	312253-2	852114-1	—	318813-1

Note:

1. Use these contacts only with the **Blindmate** connectors on page 5122.

Insert Arrangements

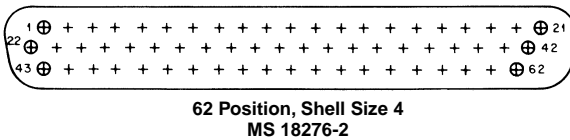
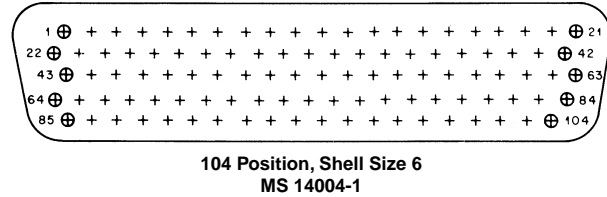
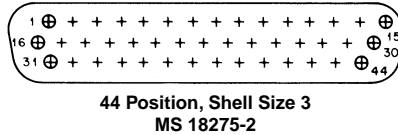
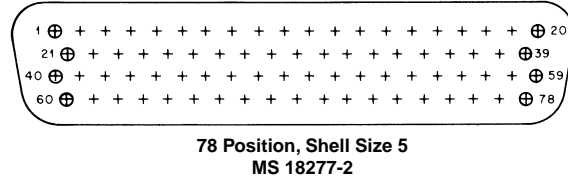
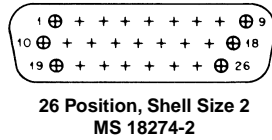
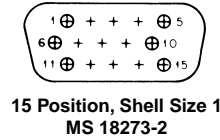

Note: Mating face of plug shown: receptacle is mirror image.

Performance Specifications

All Series 90 AMPLIMITE military connectors conform to the latest amendments of military specification MIL-DTL-24308. For more detailed information, refer to MIL-DTL-24308.

All Series 90 connectors are designed for a -67°F to 257°F [-55°C to +125°C] temperature range.

Technical Documents List

The following is a list of technical documents that cover the application and performance of AMPLIMITE Series 90 military connectors, contacts, tooling and accessories.

Military Specifications

- MIL-DTL-24308 Connectors, Electric, Rectangular, Miniature Polarized Shell, Rack and Panel, General Specifications for
- MIL-C-39029 Contacts, Electrical Connector, General Specification for

NASA Specification

- GSFC-S-311-P-4 Non-Magnetic Connectors, General Specification for

AMP Instruction Sheets

- 408-7516 AMP Application Tooling for MIL-C-39029 Contacts
- 408-7610 Application and Maintenance for AMP Hand Crimping Tool 90294-1
- 408-7508 AMP Insertion/Extraction Tools 91067-1, 91067-2 and 91067-3
- 408-7837 AMP Female Screwlock Kit 205817-8 and AMP Male Screw/Retainer Kit 211883-5

Size 22 Crimp Contacts for Series 90 Connectors (MIL-C-39029)

Size 22 Crimp, Snap-In
Contacts .030 [0.76]
Pin Diameter

Material and Finish

Pin, Socket Body — Copper alloy,
plated gold over nickel underplate
Socket Hood — Passivated stainless
steel

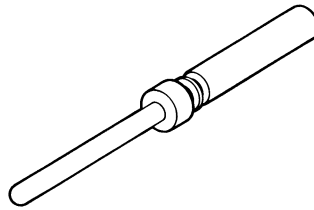

Pin
M39029/58-360
(Supersedes M24308/13-1)

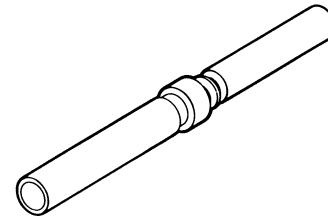

Socket
M39029/57-354
(Supersedes M24308/12-1)

Wire Size Range		Ins. Dia. (Max.)	Contact Configuration	Tape Mounted Contacts ¹		Loose Piece Contacts		Hand Tool		Contact Color Bands
AWG	[mm ²]			AMP Part No.	Military Part No. (M39029/)	AMP Part No.	Tool No. (M22520/)	Positioner No. (M22520/)		
22-28	0.4-0.8	.054 1.38	Pin	204370-5	58-360	204370-2	02-01	02-09	orange, blue, black	
			Socket	204351-2	57-354	204351-1	02-01	02-06	orange, green, yellow	

¹Tape mounted contacts are used in the AMP-TAPEMATIC Stripper/Crimper Machine Part Number **599406-7** (page 5142).

- Notes:**
1. These contacts are used in Series 90 military connectors.
 2. Insertion/Extraction Tool Part Number **91067-1** (Military Part Number **M81969/1-04**) is used to install and remove pin and socket contacts.
 3. See AMP Instruction Sheet 408-7516 for wire length, tool and selector settings.
 4. Color bands are read in the direction of terminal (wire barrel) end to mating end.

Size 22 Crimp Contacts for Series 90 Connectors (Industrial Grade)

Size 22 Crimp, Snap-In
Contacts .030 [0.76]
Pin Diameter

Material and Finish

Pin Body — Copper alloy with
.000050-.000100 [0.00127-0.00254]
gold plate over .000050-.000150
[0.00127-0.00381] nickel underplate

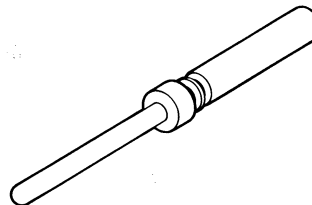

Pin

Wire Size Range		Ins. Dia. (Max.)	Contact Configuration	Tape Mounted Contacts ¹ Part No.	Loose Piece Contacts Part No.	Hand Tool	
AWG	[mm ²]					Tool No. (M22520/)	Positioner No. (M22520/)
22-28	0.4-0.8	.054 1.38	Pin	1218699-2	1218699-1	02-01	02-09
			Socket	—	—	—	—

¹Tape mounted contacts are used in the AMP-TAPEMATIC Stripper/Crimper Machine Part Number **599406-7** (page 5142).

- Notes:**
1. These contacts are used in Series 90 connectors.
 2. Insertion/Extraction Tool Part Number **91067-1** (Military Part Number **M81969/1-04**) is used to install and remove pin and socket contacts.
 3. See AMP Instruction Sheet 408-7516 for wire length, tool and selector settings.

Size 22 Posted Contacts for Series 90 Connectors

Size 22 Posted Contacts

Material and Finish

Pin and Socket Body — Leaded nickel copper or beryllium copper

Socket Hood — See chart below



Pin and Socket Insertion/Extraction Tool

AMP Part Number 91067-1 or MIL Part Number M81969/1-04
 Insertion tip, for replacement Part Number 126237-1
 Extraction tip, for replacement Part Number 126195-2

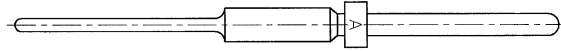

Pin
(See drawing No. 207683 for latest configurations)

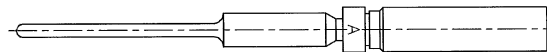

Socket
(See drawing No. 207684 for latest configurations)

Notes:

1. Contacts on this page can be used with connectors on pages 5130-5134, 5140. See page 5145 for PCB layouts.
2. Mating End of pin and socket complies with MIL-C-39029.

Post Diameter ± .002 [± .050]	Post Extension C ± .025 [± 0.63]	Part Nos.		Contact Plating	Socket Hood Material and Finish	
		Pin	Socket			
.018 0.46	.175 4.45	207683-6	207684-3	Pin .000050-.000100 [0.00127-0.00254] thick gold plate over	Socket .000050-.000100 [0.00127-0.00254] thick gold plate over	Brass or Beryllium copper with .000050-.000100 [0.00127-0.00254] thick gold plate over .000100-.000250 [0.00254-0.00635] thick copper underplate
	.275 6.99	207683-2	207684-1	.000100-.000150 [0.00254-0.00381] thick copper underplate	.000100-.000250 [0.00254-0.00635] thick copper underplate	
	.525 13.34	207683-4	207684-2			
.025 0.64	.275 6.99	207683-8	207684-4	.000050-.000100 [0.00127-0.00254] thick gold plate over .000050-.000150 [0.00127-0.00381] thick nickel underplate		Passivated Stainless Steel
	.275 6.99	—	207684-5	.000050-.000100 [0.00127-0.00254] thick gold plate over		
.018 0.46	.525 13.34	207683-9	—	.000050-.000150 [0.00127-0.00381] thick nickel underplate		Passivated Stainless Steel
	.175 4.45	1-207683-1	—	.000050-.000100 [0.00127-0.00254] thick gold plate over .000200-.000250 [0.00508-0.00635] thick nickel underplate		

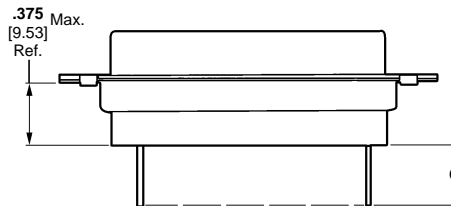

Post extension when used in a standard connector

(MIL Qualified)

Material and Finish

Shell — Steel, cadmium plated

Insert — Approved material per MIL-DTL-24308

Retention Clips — Stainless steel or copper alloy

(Industrial Grade)

Material and Finish

Shell — Steel, zinc plated

Insert — Polyphenylene Sulfide (PPS)

Retention Clips — Stainless steel or copper alloy

Related Product Data

Cavity Identification — page 5127

Contacts — pages 5128, 5129

Mounting, Mating Dimensions — page 5143

Accessories — pages 5148-5150

Attention: MIL Qualified Connector marking

Connector marking may differ from package marking. All connectors marked per MIL-DTL-24308.

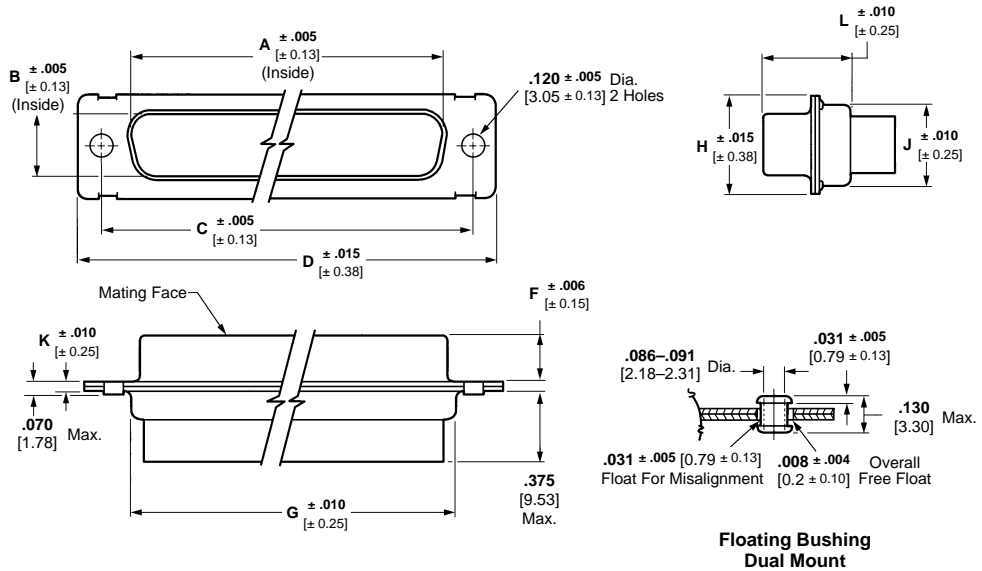

No. of Contact Pos. (Shell Size)	Dimensions											MIL Qualified				Description	Industrial Grade ³ Standard Mount Part No.
	A	B	C	D	F	G	H	J	K	L	Standard Mount		Floating Bushing Mount				
	Military Part No. ² M24308/	AMP Part No.	Military Part No. M24308/	AMP Part No.													
15 (1)	.666	.329	.984	1.213	.235	.759	.494	.422	.030	.422	4-264F	204501-1	4-329F	204525-1	Plug only	1218746-1	
	16.92	8.36	24.99	30.81	5.97	19.28	12.55	10.72	0.76	10.72	4-11F	204513-2	4-307F	204537-2	Plug with pins ¹	—	
26 (2)	.994	.329	1.312	1.541	.235	1.083	.494	.422	.030	.422	4-265F	204503-1	4-330F	204527-1	Plug only	1218746-2	
	25.25	8.36	33.32	39.14	5.97	27.51	12.55	10.72	0.76	10.72	4-12F	204515-2	4-308F	204539-2	Plug with pins ¹	—	
44 (3)	1.534	.329	1.852	2.088	.230	1.625	.494	.422	.039	.426	4-266F	204505-1	4-331F	204529-1	Plug only	1218746-3	
	38.96	8.36	47.04	53.04	5.84	4.13	12.55	10.72	0.99	10.82	4-13F	204517-2	4-309F	204541-2	Plug with pins ¹	—	
62 (4)	2.182	.329	2.500	2.729	.230	2.272	.494	.422	.039	.426	4-267F	204507-1	4-332F	204531-1	Plug only	1218746-4	
	55.42	8.36	63.5	69.32	5.84	57.7	12.55	10.72	0.99	10.82	4-14F	204519-2	4-310F	204543-2	Plug with pins ¹	—	
78 (5)	2.079	.441	2.406	2.635	.230	2.178	.605	.534	.039	.426	4-268F	204509-1	4-333F	204533-1	Plug only	1218746-5	
	52.81	11.2	61.11	66.93	5.84	55.32	15.37	13.56	0.99	10.82	4-15F	204521-2	4-311F	204545-2	Plug with pins ¹	—	
104 (6)	2.212	.503	2.500	2.729	.230	2.302	.668	.596	.039	.426	4-269F	204511-1	4-334F	204535-1	Plug only	1218746-6	
	56.18	12.78	63.5	69.32	5.84	58.47	16.97	15.14	0.99	10.82	4-16F	204523-2	4-312F	204547-2	Plug with pins ¹	—	

Notes: See pages 5151 through 5155 (military to AMP Part Number cross reference) for additional part numbers.
¹ Size 22 sockets supplied with receptacles are loose piece.
² "F" is stamped on connectors following M24308 part number as required. "F" designates cadmium shell plating.
³ Meets requirements of MIL-DTL-24308.

Crimp Receptacles, Series 90, High Density Connectors

(MIL Qualified)

Material and Finish

Shell — Steel, cadmium plated

Insert — Approved material per MIL-DTL-24308

Retention Clips — Stainless steel or copper alloy

(Industrial Grade)

Material and Finish

Shell — Steel, zinc plated

Insert — Polyphenylene Sulfide (PPS)

Retention Clips — Stainless steel or copper alloy

Related Product Data

Cavity Identification — page 5127

Contacts — pages 5128, 5129

Mounting, Mating Dimensions — page 5143

Accessories — pages 5148-5150

Attention: Connector marking

Connector marking may differ from package marking. All connectors marked per MIL-DTL-24308.

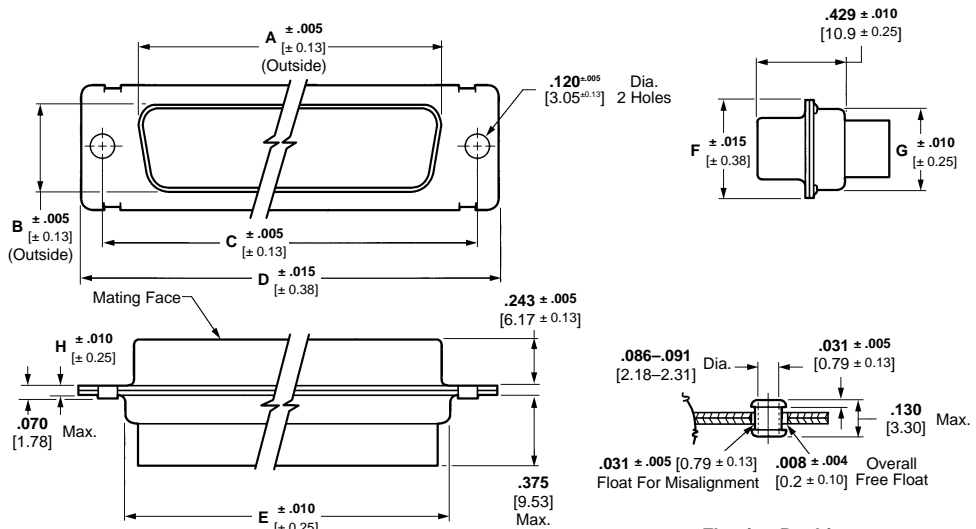

Floating Bushing Dual Mount



Clinch Nut Mount

No. of Contact Pos. (Shell Size)	Dimensions								MIL Qualified				Description	Industrial Grade ³ Clinch Nut Mount Part No.
	A	B	C	D	E	F	G	H	Standard Mount		Floating Bushing Mount			
	Military Part No. ² M24308/	AMP Part No.	Military Part No. ² M24308/	AMP Part No.	Military Part No. ² M24308/	AMP Part No.	Military Part No. ² M24308/	AMP Part No.	Military Part No. ² M24308/	AMP Part No.	Military Part No. ² M24308/	AMP Part No.		
15 (1)	.643 [16.33]	.311 [7.9]	.984 [24.99]	1.213 [30.81]	.759 [19.28]	.494 [12.55]	.422 [10.72]	.030 [0.76]	2-286F	204500-1	2-297F	204524-1	Recept. only	1218747-1
26 (2)	.971 [24.66]	.311 [7.9]	1.312 [33.32]	1.541 [39.14]	1.083 [27.51]	.494 [12.55]	.422 [10.72]	.030 [0.76]	2-287F	204502-1	2-298F	204526-1	Recept. only	1218747-2
									2-12F	204514-2	2-29F	204538-2	Recept. with sockets ¹	—
44 (3)	1.511 [38.38]	.311 [7.9]	1.852 [47.04]	2.088 [53.04]	1.625 [41.3]	.494 [12.55]	.422 [10.72]	.039 [0.99]	2-288F	204504-1	2-299F	204528-1	Recept. only	1218747-3
									2-13F	204516-2	2-30F	204540-2	Recept. with sockets ¹	—
62 (4)	2.159 [54.84]	.311 [8.36]	2.500 [63.5]	2.729 [69.32]	2.272 [57.7]	.494 [12.55]	.422 [10.72]	.039 [0.99]	2-289F	204506-1	2-300F	204530-1	Recept. only	1218747-4
									2-14F	204518-2	2-31F	204542-2	Recept. with sockets ¹	—
78 (5)	2.064 [52.43]	.423 [10.74]	2.406 [61.11]	2.635 [66.93]	2.178 [55.32]	.605 [15.37]	.534 [13.56]	.039 [0.99]	2-290F	204508-1	2-301F	204532-1	Recept. only	1218747-5
									2-15F	204520-2	2-32F	204544-2	Recept. with sockets ¹	—
104 (6)	2.189 [55.6]	.485 [12.32]	2.500 [63.5]	2.729 [69.32]	2.302 [58.47]	.668 [16.97]	.596 [15.14]	.039 [0.99]	2-291F	204510-1	2-302F	204534-1	Recept. only	1218747-6
									2-16F	204522-2	2-33F	204546-2	Recept. with sockets ¹	—

Notes: See pages 5151 through 5155 (military to AMP Part Number cross reference) for additional part numbers.

¹ Size 22 sockets supplied with receptacles are loose piece.

² "F" is stamped on connectors following M24308 part number as required. "F" designates cadmium shell plating.

³ Meets requirements of MIL-DTL-24308.

Non-Magnetic Crimp Plugs, Series 90, High Density Connectors
(NASA Qualified)

Connector Material and Finish

Shell — Brass, gold plated

Insert — Approved material per MIL-DTL-24308

Retention Clips — Copper alloy

Related Product Data

Cavity Identification — page 5127

Mounting, Mating Specifications — page 5143

Accessories — pages 5148-5150

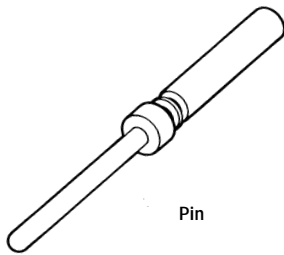
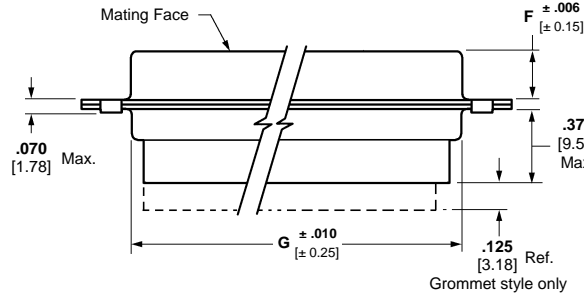
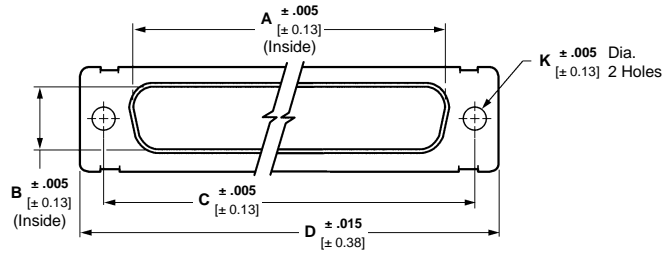

Pin

Non-Magnetic Plugs per NASA Specification

Wire Size Range	AMP Part No. / NASA No.
22-28 0.4-0.08	204370-8 G-08-P1
26-28 0.15-0.08	206495-3 —

Max. insulation diameter .054 [1.38]
Hand tool AMP Part Number 601966-1
or MIL Part Number M22520/2-01
Positioner AMP Part Number 601966-6
or MIL Part Number M22520/2-09

Contact Material and Finish

Copper alloy, .000050–.000100
[0.00127–0.0254] thick gold plate over
.000100–.000150 [0.0254–0.00381]
thick copper underplate

No. of Contact Pos. (Shell Size)	Dimensions										NASA No.	AMP Part No.	
	A	B	C	D	F	G	H	J	L	K			
15 (1)	.666 16.92	.329 8.36	.984 24.99	1.213 30.81	.235 5.97	.759 19.28	.494 12.55	.422 10.72	.422 10.72	.154 3.91	.120 3.05	311P407-1P-B-15	206498-1
26 (2)	.994 25.25	.329 8.36	1.312 33.32	1.541 39.14	.235 5.97	1.083 27.51	.494 12.55	.422 10.72	.422 10.72	.154 3.91	.120 3.05	311P407-2P-B-15 311P407-2P-B-12	206500-1 206500-4
44 (3)	1.534 38.96	.329 8.36	1.852 47.04	2.088 53.04	.230 5.84	1.625 41.3	.494 12.55	.422 10.72	.426 10.82	.154 3.91	.120 3.05	311P407-3P-B-15 311P407-3P-B-12	206063-2 206063-4
62 (4)	2.182 55.42	.329 8.36	2.500 63.5	2.729 69.32	.230 5.84	2.272 57.7	.494 12.55	.422 10.72	.426 10.82	.154 3.91	.120 3.05	311P407-4P-B-15 311P407-4P-B-12	206502-1 206502-4
78 (5)	2.079 52.81	.441 11.20	2.406 61.11	2.635 66.93	.230 5.84	2.178 57.7	.605 15.37	.534 13.56	.426 10.82	.154 3.91	.120 3.05	311P407-5P-B-15 311P407-5P-B-12	206504-1 206504-4
104 (6)	2.212 56.18	.503 12.78	2.500 63.5	2.729 69.32	.230 5.84	2.302 58.47	.668 16.97	.596 15.14	.426 10.82	.154 3.91	.120 3.05	311P407-6P-B-15 311P407-6P-B-12	206066-2 206066-4

Non-Magnetic Plugs With Silicone Rubber Rear Grommet¹



Pin and Socket Insertion/Extraction Tool

AMP Part Number 91067-1 or MIL Part Number M81969/1-04
Insertion tip, for replacement Part Number 126237-1
Extraction tip, for replacement Part Number 126195-2

No. of Contact Pos. (Shell Size)	Dimensions										AMP Part No.	
	A	B	C	D	F	G	H	J	K	L		
15 (1)	.666 16.92	.329 8.36	.984 24.99	1.213 30.81	.235 5.97	.759 19.28	.494 12.55	.422 10.72	.422 10.72	.120 3.05	.422 10.72	211673-4
26 (2)	.994 25.25	.329 8.36	1.312 33.32	1.541 39.14	.235 5.97	1.083 27.51	.494 12.55	.422 10.72	.422 10.72	.120 3.05	.422 10.72	211674-4
44 (3)	1.534 38.96	.329 8.36	1.852 47.04	2.088 53.04	.230 5.84	1.625 41.3	.494 12.55	.422 10.72	.426 10.82	.120 3.05	.426 10.82	211675-4
62 (4)	2.182 55.42	.329 8.36	2.500 63.5	2.729 69.32	.230 5.84	2.272 57.7	.494 12.55	.422 10.72	.426 10.82	.120 3.05	.426 10.82	211676-4
78 (5)	2.079 52.81	.441 11.20	2.406 61.11	2.635 66.93	.230 5.84	2.178 55.32	.605 15.37	.534 13.56	.426 10.82	.120 3.05	.426 10.82	211677-4
104 (6)	2.212 56.18	.503 12.78	2.500 63.5	2.729 69.32	.230 5.84	2.302 58.47	.668 16.97	.596 15.14	.426 10.82	.120 3.05	.426 10.82	211678-4

¹ Grommet provided for cable strain relief.

Non-Magnetic Crimp Receptacles, Series 90, High Density Connectors (NASA Qualified)

Connector Material and Finish

Shell — Brass, gold plated

Insert — Approved material per MIL-DTL-24308

Retention Clips — Copper alloy

Related Product Data

Cavity Identification — page 5127

Mounting, Mating Specifications — page 5143

Accessories — pages 5148-5150

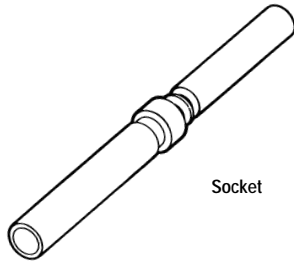
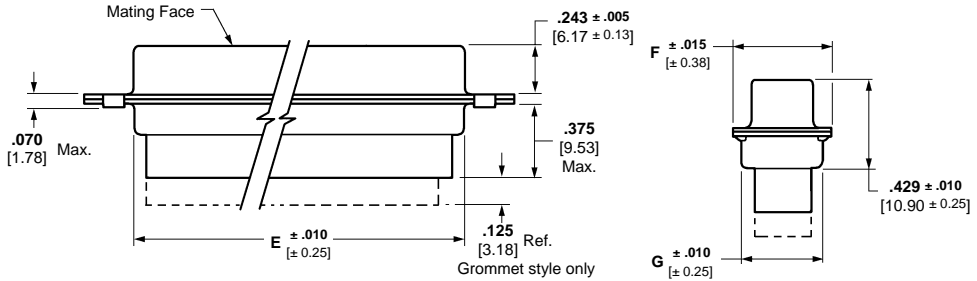
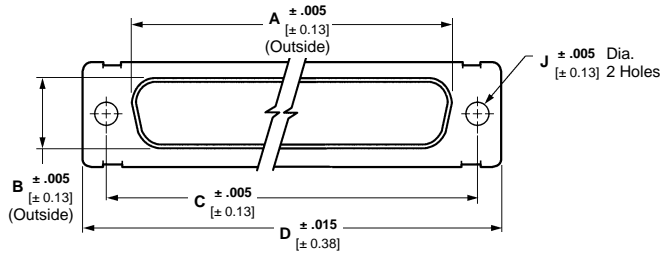

Socket

Wire Size Range	AMP Part No. / NASA No.
22-28 0.4-0.08	206071-1 G-08-S1
26-28 0.15-0.08	206496-1 —

Max. insulation diameter .054 [1.38]
Hand tool AMP Part Number 601966-1 or MIL Part Number M22520/2-01
Positioner AMP Part Number 601966-4 or MIL Part Number M22520/2-06

Contact and Hood Material and Finish

Copper alloy, .000050-.000100 [0.00127-0.0254] thick gold plate over .000100-.000150 [0.0254-0.00381] thick copper underplate

Non-Magnetic Receptacles per NASA Specification

No. of Contact Pos. (Shell Size)	Dimensions									NASA No.	AMP Part No.
	A	B	C	D	E	F	G	J			
15 (1)	.643	.311	.984	1.213	.759	.494	.422	.154	3.91	311P407-1S-B-15	206499-1
	16.33	7.9	24.99	30.81	19.28	12.55	10.72	.120	3.05		
26 (2)	.971	.311	1.312	1.541	1.083	.494	.422	.154	3.91	311P407-2S-B-15	206501-1
	24.66	7.9	33.32	39.14	27.51	12.55	10.72	.120	3.05		
44 (3)	1.511	.311	1.852	2.088	1.625	.494	.422	.154	3.91	311P407-3S-B-15	206064-2
	38.38	7.9	47.04	53.04	41.3	12.55	10.72	.120	3.05		
62 (4)	2.159	.311	2.500	2.729	2.272	.494	.422	.154	3.91	311P407-4S-B-15	206503-1
	54.84	7.9	63.5	69.32	57.7	12.55	10.72	.120	3.05		
78 (5)	2.064	.423	2.406	2.635	2.178	.605	.534	.154	3.91	311P407-5S-B-15	206505-1
	52.43	10.74	61.11	66.93	55.32	15.37	13.56	.120	3.05		
104 (6)	2.189	.485	2.500	2.729	2.302	.668	.596	.154	3.91	311P407-6S-B-15	206065-2
	55.6	12.32	63.5	69.32	58.47	16.97	15.14	.120	3.05		

Non-Magnetic Receptacles With Silicone Rubber Rear Grommet¹



Pin and Socket Insertion/Extraction Tool

AMP Part Number 91067-1 or MIL Part Number M81969/1-04
Insertion tip, for replacement Part Number 126237-1
Extraction tip, for replacement Part Number 126195-2

No. of Contact Pos. (Shell Size)	Dimensions									AMP Part No.
	A	B	C	D	E	F	G	J		
15 (1)	.643	.311	.984	1.213	.759	.494	.422	.120	3.05	211667-4
	16.33	7.9	24.99	30.81	19.28	12.55	10.72	3.05		
26 (2)	.971	.311	1.312	1.541	1.083	.494	.422	.120	3.05	211668-4
	24.66	7.9	33.32	39.14	27.51	12.55	10.72	3.05		
44 (3)	1.511	.311	1.852	2.088	1.625	.494	.422	.120	3.05	211669-4
	38.38	7.9	47.04	53.04	41.3	12.55	10.72	3.05		
62 (4)	2.159	.311	2.500	2.729	2.272	.494	.422	.120	3.05	211670-4
	54.84	7.9	63.5	69.32	57.7	12.55	10.72	3.05		
78 (5)	2.064	.423	2.406	2.635	2.178	.605	.534	.120	3.05	211671-4
	52.43	10.74	61.11	66.93	55.32	15.37	13.56	3.05		
104 (6)	2.189	.485	2.500	2.729	2.302	.668	.596	.120	3.05	211672-4
	55.6	12.32	63.5	69.32	58.47	16.97	15.14	3.05		

¹ Grommet provided for cable strain relief.

Crimp Blindmate Plugs, Series 90, High Density Connectors

Material and Finish

Shell, Front — Aluminum alloy, cadmium plated with yellow chromate

Shell, Rear — Steel, cadmium plated with yellow chromate

Insert Assembly — Approved material per MIL-DTL-24308

Retention Clips — Stainless steel

Related Product Data

Cavity Identification — page 5127

Contacts — pages 5128, 5129

Mounting Specifications — page 5143

Flange to flange spacing can be a max. of .270 [6.86] for Blindmate connectors.

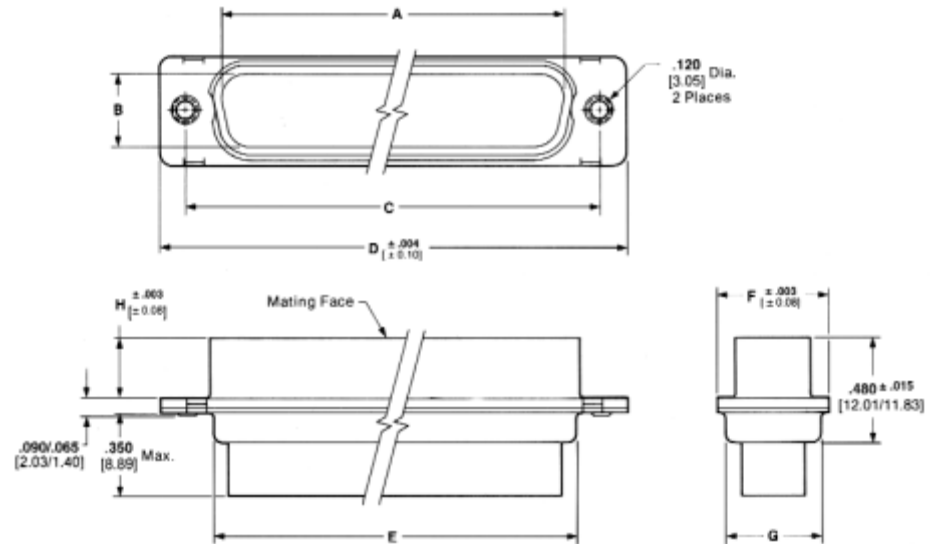

No. of Contact Pos. (Shell Size)	Dimensions								AMP Part No.
	A	B	C	D	E	F	G	H	
15 (1)	.656 16.66	.324 8.23	.984 24.99	1.224 31.09	.769/.750 19.53/19.05	.506 12.85	.432/.413 10.97/10.49	.257 6.53	213153-1
26 (2)	.984 25.0	.324 8.23	1.312 33.32	1.552 39.42	1.093/1.074 27.76/27.28	.506 12.85	.432/.413 10.97/10.49	.257 6.53	445010-1
44 (3)	1.524 38.71	.324 8.23	1.852 47.04	2.099 53.31	1.635/1.616 41.53/41.05	.506 12.85	.432/.413 10.97/10.49	.257 6.53	445011-1
62 (4)	2.172 55.17	.324 8.23	2.500 63.5	2.740 69.6	2.282/2.263 57.96/57.48	.506 12.85	.432/.413 10.97/10.49	.257 6.53	213118-1
78 (5)	2.082 52.88	.444 11.28	2.406 61.11	2.646 67.21	2.188/2.167 55.58/55.04	.617 15.67	.544/.525 13.82/13.34	.257 6.53	445012-1
104 (6)	2.212 56.18	.503 12.78	2.500 63.5	2.740 69.6	2.302 58.47	.680 17.27	.606/.587 15.39/14.91	.267 6.78	212933-3

Straight PCB, Series 90, High Density Connectors (Industrial Grade)

Material and Finish

- Shell — Steel, cadmium plated
- Insert — Polyphenylene Sulfide (PPS)
- Retention Clips — Stainless steel

Related Product Data

- Cavity Identification — page 5127
- Contacts — page 5129
- Mounting, Mating Dimensions — page 5143
- Accessories — pages 5148-5150
- PCB Layouts — See page 5145 or AMP customer drawing

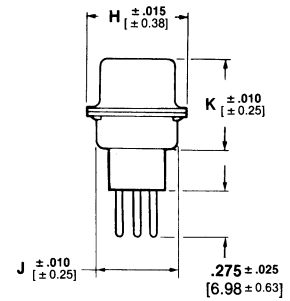
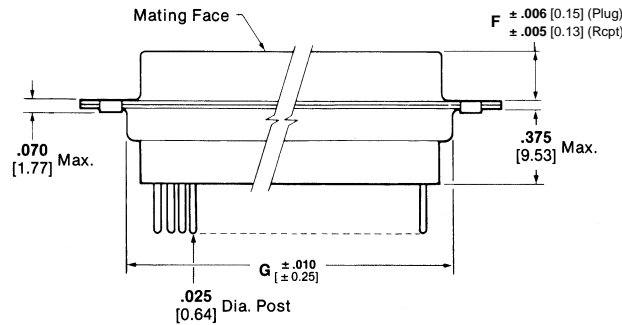
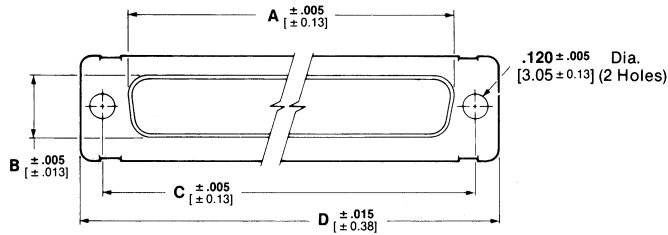

Replacement Pin Contact
Part Number 207683-8

Plugs

No. of Contact Pos. (Shell Size)	Dimensions										AMP Part No.
	A (Inside)	B (Inside)	C	D	F	G	H	J	K		
15 (1)	.666 16.92	.329 8.36	.984 24.99	1.213 30.81	.235 5.97	.759 19.28	.494 12.55	.422 10.72	.422 10.72	208866-1	
26 (2)	.994 25.25	.329 8.36	1.312 33.32	1.541 39.14	.235 5.97	1.083 27.51	.494 12.55	.422 10.72	.422 10.72	208867-1	
44 (3)	1.534 38.96	.329 8.36	1.852 47.04	2.088 53.04	.230 5.84	1.625 41.3	.494 12.55	.422 10.72	.426 10.82	208868-1	
62 (4)	2.182 55.42	.329 8.36	2.500 63.5	2.729 69.32	.230 5.84	2.272 57.7	.494 12.55	.422 10.72	.426 10.82	208869-1	
78 (5)	2.079 52.81	.441 11.20	2.406 61.11	2.635 66.93	.230 5.84	2.178 55.32	.605 15.37	.534 13.56	.426 10.82	208870-1	
104 (6)	2.212 56.18	.503 12.78	2.500 63.5	2.729 69.32	.230 5.84	2.302 58.47	.668 16.97	.596 15.14	.426 10.82	208871-1	

Replacement Socket Contact
Part Number 207684-4

Receptacles

No. of Contact Pos. (Shell Size)	Dimensions										AMP Part No.
	A (Outside)	B (Outside)	C	D	F	G	H	J	K		
15 (1)	.643 16.33	.311 7.9	.984 24.99	1.213 30.81	.243 6.17	.759 19.28	.494 12.55	.422 10.72	.429 10.9	208872-1	
26 (2)	.971 24.66	.311 7.9	1.312 33.32	1.541 39.14	.243 6.17	1.083 27.51	.494 12.55	.422 10.72	.429 10.9	208873-1	
44 (3)	1.511 38.38	.311 7.9	1.852 47.04	2.088 53.04	.243 6.17	1.625 41.3	.494 12.55	.422 10.72	.429 10.9	208874-1	
62 (4)	2.159 54.84	.311 7.9	2.500 63.5	2.729 69.32	.243 6.17	2.272 57.7	.494 12.55	.422 10.72	.429 10.9	208875-1	
78 (5)	2.064 52.43	.423 10.74	2.406 61.11	2.635 66.93	.243 6.17	2.178 55.32	.605 15.37	.534 13.56	.429 10.9	208876-1	
104 (6)	2.189 55.6	.485 12.32	2.500 63.5	2.729 69.32	.243 6.17	2.302 58.47	.668 16.97	.596 15.14	.429 10.9	208877-1	

Right-Angle PCB, Series 90, with Female Screwlocks

Material and Finish

Shell — Brass, gold over copper plated

Insert — Diallyl phthalate or polyester or Polyphenylene Sulfide (PPS)

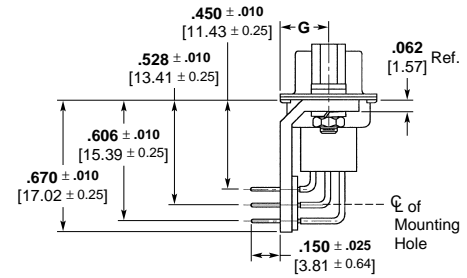
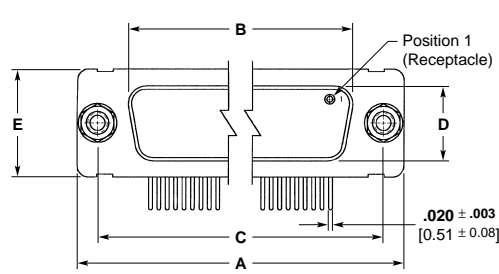

Shell Size 1 thru 4

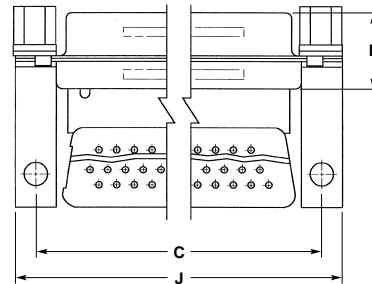

Plugs

No. of Contact Pos. (Shell Size)	Dimensions									AMP Part No.
	A	B	C	D	E	F	G	J		
15 (1)	1.213 30.81	.666 16.92	.984 24.99	.329 8.36	.494 12.55	.422 10.72	.246 ± .010 6.25 ± 0.25	1.204 30.58		1-593326-7
26 (2)	1.541 39.14	.994 25.25	1.312 33.32	.329 8.36	.494 12.55	.422 10.72	.246 ± .010 6.25 ± 0.25	1.532 38.91		1-593326-8
44 (3)	2.088 53.04	1.534 38.96	1.852 47.04	.329 8.36	.494 12.55	.426 10.82	.246 ± .010 6.25 ± 0.25	2.077 52.76		1-593326-9
62 (4)	2.729 69.32	2.182 55.42	2.500 63.50	.329 8.36	.494 12.55	.426 10.82	.246 ± .010 6.25 ± 0.25	2.720 69.09		2-593326-0
78 (5)	2.635 66.93	2.079 52.81	2.406 61.11	.441 11.20	.605 15.37	.426 10.82	.246 ± .010 6.25 ± 0.25	2.626 66.70		2-593326-1
104 (6)	2.729 69.32	2.213 56.21	2.500 63.50	.503 12.78	.668 16.97	.426 10.82	.246 ± .010 6.25 ± 0.25	2.720 69.09		2-593326-2

Receptacles

No. of Contact Pos. (Shell Size)	Dimensions									AMP Part No.
	A	B	C	D	E	F	G	J		
15 (1)	1.213 30.81	.643 16.33	.984 24.99	.311 7.90	.494 12.55	.422 10.72	.248 ± .010 6.30 ± 0.25	1.204 30.58		1-593327-7
26 (2)	1.541 39.14	.971 24.66	1.312 33.32	.311 7.90	.494 12.55	.422 10.72	.248 ± .010 6.30 ± 0.25	1.532 38.91		1-593327-8
44 (3)	2.088 53.04	1.511 38.38	1.852 47.04	.311 7.90	.494 12.55	.426 10.82	.248 ± .010 6.30 ± 0.25	2.077 52.76		1-593327-9
62 (4)	2.729 69.32	2.159 54.84	2.500 63.50	.311 7.90	.494 12.55	.426 10.82	.248 ± .010 6.30 ± 0.25	2.720 69.09		2-593327-0
78 (5)	2.635 66.93	2.064 52.43	2.406 61.11	.423 10.74	.605 15.37	.426 10.82	.248 ± .010 6.30 ± 0.25	2.626 66.70		2-593327-1
104 (6)	2.729 69.32	2.188 55.58	2.500 63.50	.485 12.32	.668 16.97	.426 10.82	.248 ± .010 6.30 ± 0.25	2.726 69.24		2-593327-2

Connector savers prolong the life of permanently installed connectors which would otherwise be subjected to repeated cycles of mating and unmating, in applications such as test interfaces or on testing devices.

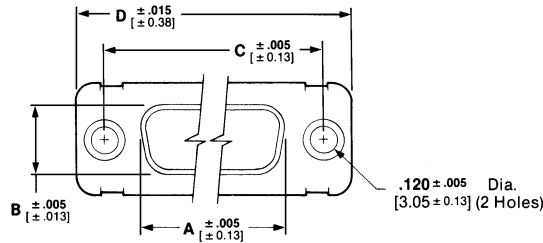

Material and Finish

Standard

Shell — Steel, cadmium plated
Contact Body — Beryllium copper, .000050 [0.00127] min. gold plate over .000050 [0.00127] min. nickel underplate

Socket Hood — Passivated stainless steel

Insert — Polyphenylene Sulfide (PPS)

Spacer — Black nylon

Non Magnetic

Shell — Brass, gold plated

Contact Body — Beryllium copper, .000050 [0.00127] min. gold plate over .000050 [0.00127] min. copper underplate

Socket Hood — Brass, .000050 [0.00127] min. gold plate over .000100 [0.00254] min. copper underplate

Insert — Polyphenylene Sulfide (PPS)

Spacer — Black nylon

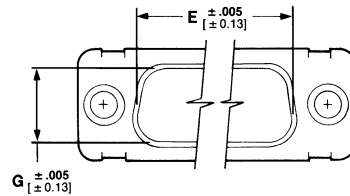
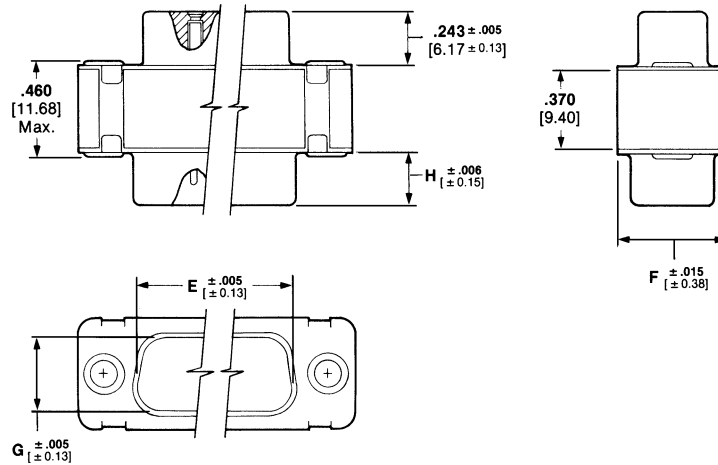

Dimensions							
A (Outside)	B (Outside)	C	D	E (Inside)	F	G (Inside)	H
.643 16.33	.311 7.9	.984 24.99	1.213 30.81	.666 16.92	.494 12.55	.329 8.36	.235 5.97
.971 24.66	.311 7.9	1.312 33.32	1.541 39.14	.994 25.25	.494 12.55	.329 8.36	.235 5.97
1.511 38.38	.311 7.9	1.852 47.04	2.088 53.04	1.534 38.96	.494 12.55	.329 8.36	.230 5.84
2.159 54.84	.311 7.9	2.500 63.5	2.729 69.32	2.182 55.42	.494 12.55	.329 8.36	.230 5.84
2.064 52.43	.423 10.74	2.406 61.11	2.635 66.93	2.079 52.81	.605 15.37	.441 11.20	.230 5.84
2.189 55.60	.485 12.32	2.500 63.5	2.729 69.32	2.212 56.18	.668 16.97	.503 12.78	.230 5.84

No. of Contact Pos. (Shell Size)	Standard (Cadmium Over Steel)	Non-Magnetic (Gold Over Brass)
15 (1)	211010-1	211010-4
26 (2)	211011-1	211011-4
44 (3)	211012-1	211012-4
62 (4)	211013-1	211013-4
78 (5)	211014-1	211014-4
104 (6)	211015-1	211015-4

Introduction

Product Facts

- One-piece aluminum shells for light-weight and enhanced EMI performance
- Connectors are typically 15–20% lighter than brass counterparts
- Interates/interchanges with existing designs
- Enhanced EMI performance over brass shells by 10–20 dB
- Series 109 Plugs & Receptacles shell size 1 through 5 (9-50 positions)
- Series 90 Plugs & Receptacles in shell size 1 through 6 (15-104 positions)
- Can be provided with or without grommet
- Plug shells include grounding indents
- Designed to meet NASA 311P
- Designed to meet MIL-DTL-24308D specification
- DSCC Drawings 99012 through 99015

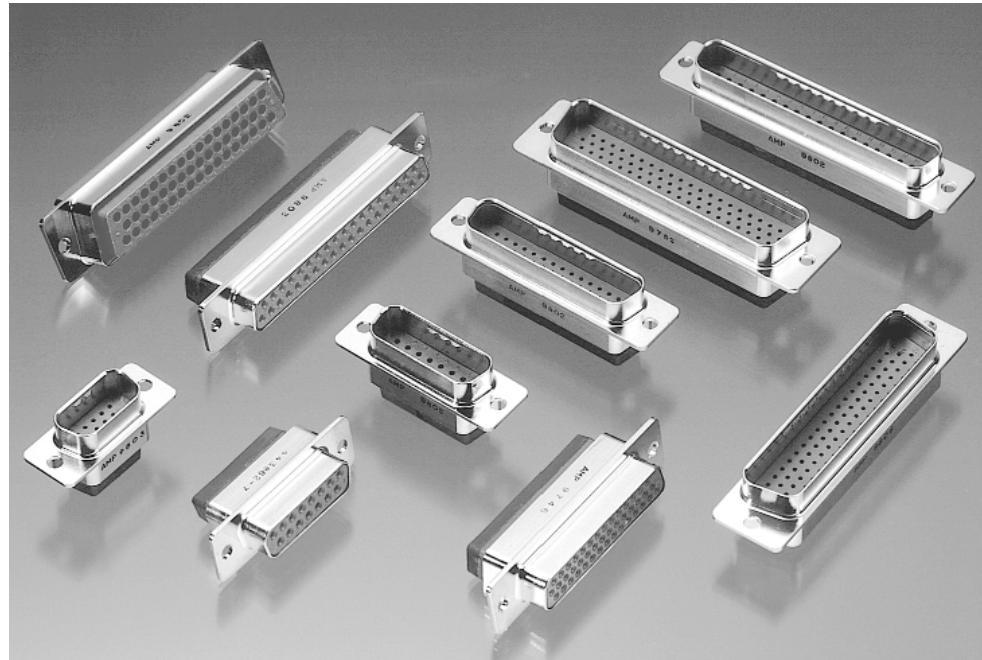

Material and Finish

Housing Material — Polyphenylene Sulfide (PPS)

Shell Finish — .000050 [0.00127] min. gold plate over .00100–.00125 [0.0254–0.0318] nickel underplate

Shell Material — Aluminum alloy

Temperature Range — -67°F to 257°F [-55°C to 125°C]

Voltage Rating — 300 V

Current Rating — Contact current rating per MIL-C-39029

Size 20 — 7.5 amps in free air
Size 22 — 5.0 amps in free air (refer to MIL Spec. for cable specifications)

Low Level Termination Resistance

— 11 Ohm max. 109 Series, 17 milliohms only for 90 Series per MIL-C-39029

Performance Characteristics

Dielectric Withstanding Voltage — 1000 VAC between adjacent pos.

Insulation Resistance — Min. 1000 milliohm between adjacent pos.

Voltage Rating — 300 V

Durability — Up to 500 matings/cycle

Vibration — 3.13 G's RMS between 5–500 Hz 15 minutes per plane

Physical Shock — 18 drops, half-sine 30 G's at 11 millisecond

Temperature Range — -67°F to 257°F [-55°C to 125°C]

Thermal Shock — -67°F to 257°F [-55°C to 125°C]

Temperature-Humidity — 77°F to 149°F [+25°C to +65°C] at 95% relative humidity

Corrosion — Mixed flowing gas, class II

Product Specifications — 108-1834 (Design objectives)

Weight Comparisons for the AMPLIMITE Connector Series 90 (1) PC AL vs the (2) PC Brass NASA Grade Connector Assemblies

Receptacles

Shell Size	Connector Position	Aluminum Shell Assy. Without Grommet	Brass Shell Assy. Without Grommet	Brass to Aluminum % Difference Without Grommet
1	15	4	5.2	23.1%
2	26	6.2	7.5	17.3%
3	44	9	10.9	17.4%
4	62	12.4	15.3	19.0%
5	78	15.3	17.9	14.5%
6	104	17.2	20	14.0%

Note: All weight values are in grams.

Plugs

Shell Size	Connector Position	Aluminum Shell Assy. Without Grommet	Brass Shell Assy. Without Grommet	Brass to Aluminum % Difference Without Grommet
1	15	3.6	4.6	21.7%
2	26	5.3	6.2	14.5%
3	44	7.8	10.3	24.3%
4	62	10.9	14.1	22.7%
5	78	12.7	15.9	20.1%
6	104	14.3	17.5	18.3%

Note: All weight values are in grams.

ULTRA-LITE Connector Plugs and Receptacles, Series 109

Connector Material and Finish

Shell — Aluminum alloy, gold plated per MIL-G-45204 over nickel per MIL-C-26074.

Insert — Blue diallyl phthalate per MIL-M-14 or black Polyphenylene Sulfide (PPS) per MIL-M-24519 or blue thermoplastic per MIL-M-24519

Retention Clips — Beryllium copper

Grommet — Silicon rubber per ZZ-R-765, color: red

Contacts — Uses size 20 crimp or posted contacts, ref. pages 5102-5104.

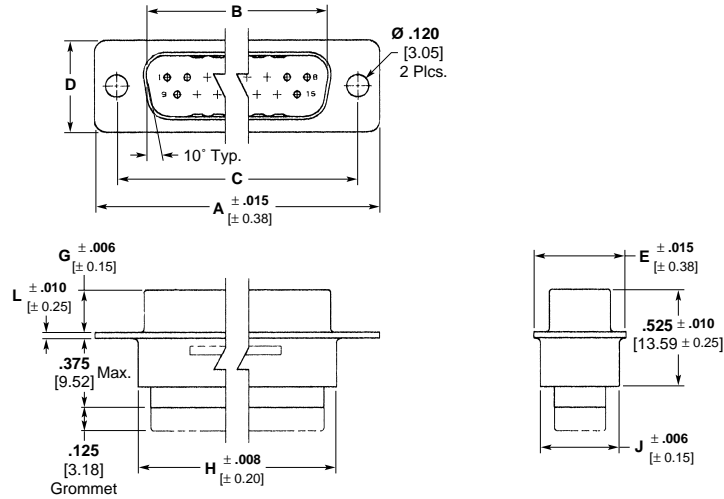

Plugs

No. of Contact Pos. (Shell Size)	Dimensions									AMP Part No.
	A	B	C	D	E	G	H	J	L	
9 (1)	1.213 30.81	.666 16.92	.984 24.99	.329 8.36	.494 12.55	.235 5.97	.770 19.56	.438 11.13	.030 0.76	1218234-1 1218234-6*
15 (2)	1.541 39.14	.994 25.25	1.312 33.32	.329 8.36	.494 12.55	.235 5.97	1.094 27.79	.438 11.13	.030 0.76	1218234-2 1218234-7*
25 (3)	2.088 53.04	1.534 38.96	1.852 47.04	.329 8.36	.494 12.55	.230 5.84	1.636 41.55	.438 11.13	.039 0.99	1218234-3 1218234-8*
37 (4)	2.729 69.32	2.182 55.42	2.500 63.50	.329 8.36	.494 12.55	.230 5.84	2.284 58.01	.438 11.13	.039 0.99	1218234-4 1218234-9*
50 (5)	2.635 66.93	2.079 52.81	2.406 61.11	.441 11.20	.605 15.38	.230 5.84	2.189 55.60	.550 13.97	.039 0.99	1218234-5 1-1218234-0*

*Rubber Grommet

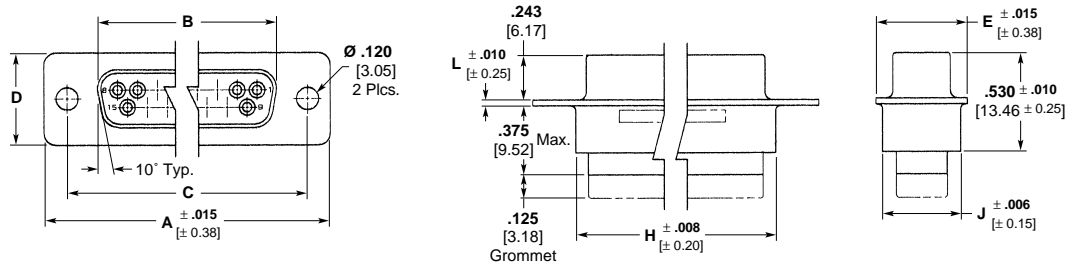

Receptacles

No. of Contact Pos. (Shell Size)	Dimensions									AMP Part No.
	A	B	C	D	E	H	J	L		
9 (1)	1.213 30.81	.643 16.33	.984 24.99	.311 7.90	.494 12.55	.770 19.56	.438 11.13	.030 0.76	1218235-1 1218235-6*	
15 (2)	1.541 39.14	.971 24.66	1.312 33.32	.311 7.90	.494 12.55	1.094 27.79	.438 11.13	.030 0.76	1218235-2 1218235-7*	
25 (3)	2.088 53.04	1.511 38.38	1.852 47.04	.311 7.90	.494 12.55	1.636 41.55	.438 11.13	.039 0.99	1218235-3 1218235-8*	
37 (4)	2.729 69.32	2.159 54.84	2.500 63.50	.311 7.90	.494 12.55	2.284 58.01	.438 11.13	.039 0.99	1218235-4 1218235-9*	
50 (5)	2.635 66.93	2.064 52.43	2.406 61.11	.423 10.74	.605 15.38	2.189 55.60	.550 13.97	.039 0.99	1218235-5 1-1218235-0*	

*Rubber Grommet

ULTRA-LITE Connector Plugs and Receptacles, Series 90

Connector Material and Finish

Shell — Aluminum alloy, gold plated per MIL-G-45204 over nickel per MIL-C-26074.

Insert — Blue diallyl phthalate per MIL-M-14 or black Polyphenylene Sulfide (PPS) per MIL-M-24519 or blue thermoplastic per MIL-M-24519

Retention Clips — Beryllium copper

Grommet — Silicon rubber per ZZ-R-765, color: red

Contacts — Uses size 22 crimp and posted contacts, ref. pages 5128 and 5129.

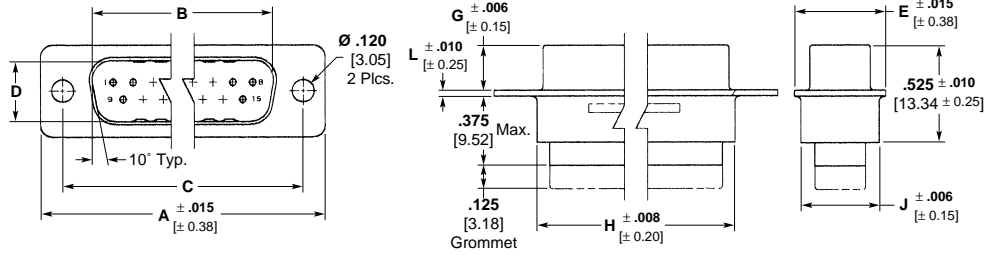

Plugs

No. of Contact Pos. (Shell Size)	Dimensions									AMP Part No.
	A	B	C	D	E	G	H	J	L	
15 (1)	1.213 30.81	.666 16.92	.984 24.99	.329 8.36	.494 12.55	.235 5.97	.770 19.56	.438 11.13	.030 0.76	1218232-1 1218232-7*
26 (2)	1.541 39.14	.994 25.25	1.312 33.32	.329 8.36	.494 12.55	.235 5.97	1.094 27.79	.438 11.13	.030 0.76	1218232-2 1218232-8*
44 (3)	2.088 53.04	1.534 38.96	1.852 47.04	.329 8.36	.494 12.55	.230 5.84	1.636 41.55	.438 11.13	.039 0.99	1218232-3 1218232-9*
62 (4)	2.729 69.32	2.182 55.42	2.500 63.50	.329 8.36	.494 12.55	.230 5.84	2.284 58.01	.438 11.13	.039 0.99	1218232-4 1-1218232-0*
78 (5)	2.635 66.93	2.079 52.81	2.406 61.11	.441 11.20	.605 15.38	.230 5.84	2.189 55.60	.550 13.97	.039 0.99	1218232-5 1-1218232-1*
104 (6)	2.729 69.32	2.212 56.18	2.500 63.50	.503 12.78	.668 16.97	.230 5.84	2.313 58.75	.608 15.44	.039 0.99	1218232-6 1-1218232-2*

*Rubber Grommet

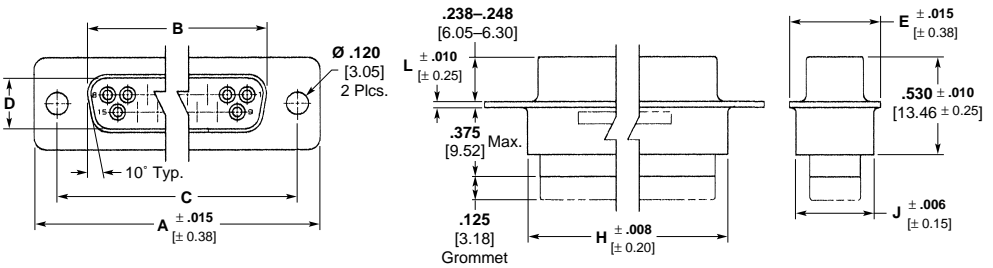

Receptacles

No. of Contact Pos. (Shell Size)	Dimensions								AMP Part No.
	A	B	C	D	E	H	J	L	
15 (1)	1.213 30.81	.644 16.36	.984 24.99	.311 7.90	.494 12.55	.770 19.56	.438 11.13	.030 0.76	1218233-1 1218233-7*
26 (2)	1.541 39.14	.972 24.69	1.312 33.32	.311 7.90	.494 12.55	1.094 27.79	.438 11.13	.030 0.76	1218233-2 1218233-8*
44 (3)	2.088 53.04	1.512 38.40	1.852 47.04	.311 7.90	.494 12.55	1.636 41.55	.438 11.13	.039 0.99	1218233-3 1218233-9*
62 (4)	2.729 69.32	2.160 54.86	2.500 63.50	.311 7.90	.494 12.55	2.284 58.01	.438 11.13	.039 0.99	1218233-4 1-1218233-0*
78 (5)	2.635 66.93	2.065 52.45	2.406 61.11	.423 10.74	.605 15.38	2.189 55.60	.550 13.97	.039 0.99	1218233-5 1-1218233-1*
104 (6)	2.729 69.32	2.190 55.63	2.500 63.50	.485 12.32	.668 16.97	2.313 58.75	.608 15.44	.039 0.99	1218233-6 1-1218233-2*

*Rubber Grommet

ULTRA-LITE AMPLIMITE Connector Part Numbers vs. NASA's 311P Part Numbers and DSCC Part Numbers

AMPLIMITE Connector Series 90 (High Density Sub "D"'s)

DSCC Part No. w/Grommet	DSCC Part No. w/out Grommet	NASA Part No. w/out Grommet	Plug / Receptacle	Shell Size	Position	ULTRA-LITE Connectors	
						Part No. w/out Grommet	Part No. with Grommet
99012SAFPRA-1	99012NAFPR-1	311P407-1P-B-12	Plug	1	15	1218232-1	1218232-7
99012SAFPRA-2	99012NAFPR-2	311P407-1P-B-12	Plug	2	26	1218232-2	1218232-8
99012SAFPRA-3	99012NAFPR-3	311P407-1P-B-12	Plug	3	44	1218232-3	1218232-9
99012SAFPRA-4	99012NAFPR-4	311P407-1P-B-12	Plug	4	62	1218232-4	1-1218232-0
99012SAFPRA-5	99012NAFPR-5	311P407-1P-B-12	Plug	5	78	1218232-5	1-1218232-1
99012SAFPRA-6	99012NAFPR-6	311P407-1P-B-12	Plug	6	104	1218232-6	1-1218232-2
99014SAESR-1	99014NAESR-1	311P407-1S-B-12	Receptacle	1	15	1218233-1	1218233-7
99014SAESR-2	99014NAESR-2	311P407-1S-B-12	Receptacle	2	26	1218233-2	1218233-8
99014SAESR-3	99014NAESR-3	311P407-1S-B-12	Receptacle	3	44	1218233-3	1218233-9
99014SAESR-4	99014NAESR-4	311P407-1S-B-12	Receptacle	4	62	1218233-4	1-1218233-0
99014SAESR-5	99014NAESR-5	311P407-1S-B-12	Receptacle	5	78	1218233-5	1-1218233-1
99014SAESR-6	99014NAESR-6	311P407-1S-B-12	Receptacle	6	104	1218233-6	1-1218233-2

AMPLIMITE Connector Series 109 (Standard Density Sub "D"'s)

DSCC Part No. w/Grommet	DSCC Part No. w/out Grommet	NASA Part No. w/out Grommet	Plug / Receptacle	Shell Size	Position	ULTRA-LITE Connectors	
						Part No. w/out Grommet	Part No. with Grommet
99013SAEPR-1	99013NAEPR-1	311P409-1P-B-12	Plug	1	9	1218234-1	1218234-7
99013SAEPR-2	99013NAEPR-2	311P409-2P-B-12	Plug	2	15	1218234-2	1218234-8
99013SAEPR-3	99013NAEPR-3	311P409-3P-B-12	Plug	3	25	1218234-3	1218234-9
99013SAEPR-4	99013NAEPR-4	311P409-4P-B-12	Plug	4	37	1218234-4	1-1218234-0
99013SAEPR-5	99013NAEPR-5	311P409-5P-B-12	Plug	5	50	1218234-5	1-1218234-1
99015SAESR-1	99015NAESR-1	311P409-1S-B-12	Receptacle	1	9	1218235-1	1218235-7
99015SAESR-2	99015NAESR-2	311P409-2S-B-12	Receptacle	2	15	1218235-2	1218235-8
99015SAESR-3	99015NAESR-3	311P409-3S-B-12	Receptacle	3	25	1218235-3	1218235-9
99015SAESR-4	99015NAESR-4	311P409-4S-B-12	Receptacle	4	37	1218235-4	1-1218235-0
99015SAESR-5	99015NAESR-5	311P409-5S-B-12	Receptacle	5	50	1218235-5	1-1218235-1

Note: AMP Part Nos. are not NASA approved parts, but will conform to NASA's performance requirements.

Application Tools for Series 109 (Size 20) Crimp Contacts



**Pin and Socket
Insertion/Extraction Tool**

AMP Part Number 91067-2 or
MIL Part Number M81969/1-02
Insertion tip, for replacement
Part Number 126195-3
Extraction tip, for replacement
Part Number 126195-4



**AMP-TAPEMATIC Stripper/
Crimper Machine Part Number
599406-7**

**Funnel Part Number 125905-1 for
Size 20 Contacts**

The AMP-TAPEMATIC Stripper/Crimper Machine strips wire and applies an 8-indent crimp termination per MIL-C-22520. The machine terminates pin and socket contacts which are tape mounted and reel fed. It offers production rates of up to 1200 finished leads per hour, provides overall lower applied costs and maintains a high degree of termination reliability.



**Hand Crimping Tool
AMP Part Number 601966-1 or
MIL Part Number M22520/2-01**

**Positioner
AMP Part Number 601966-5 or
MIL Part Number M22520/2-08**

This standard military-type hand tool terminates pins and sockets to wire with an 8-indent, M22520/2 crimp. It is ideally suited for prototype, field maintenance and other applications where volume production is not a factor.

Application Tools for Series 90 (Size 22) Crimp Contacts



**Pin and Socket
Insertion/Extraction Tool**

AMP Part Number 91067-1 or
MIL Part Number M81969/1-04
Insertion tip, for replacement
Part Number 126237-1
Extraction tip, for replacement
Part Number 126195-2



**AMP-TAPEMATIC Stripper/
Crimper Machine Part Number
599406-7**

**Funnel Part Number 125905-2 for
Size 22 Contacts**

The AMP-TAPEMATIC Stripper/Crimper Machine strips wire and applies an 8-indent crimp termination per MIL-C-22520. The machine terminates pin and socket contacts which are tape mounted and reel fed. It offers production rates of up to 1200 finished leads per hour, provides overall lower applied costs and maintains a high degree of termination reliability.



**Hand Crimping Tool
AMP Part Number 601966-1 or
MIL Part Number M22520/2-01**

**Positioner (Pin)
AMP Part Number 601966-6 or
MIL Part Number M22520/2-09**

**Positioner (Socket)
AMP Part Number 601966-4 or
MIL Part Number M22520/2-06**

This standard military-type hand tool terminates pins and sockets to wire with an 8-indent, M22520/2 crimp. It is ideally suited for prototype, field maintenance and other applications where volume production is not a factor.

Mating and Mounting Specifications for Series 109 and Series 90 Connectors

Plug Receptacle Mating

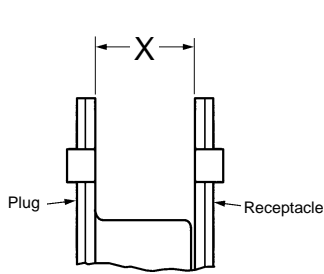

Shell Sizes 1 and 2 —
x = .280/.250 [7.11/6.35]

Shell Sizes 3, 4, 5 and 6 —
x = .271/.241 [6.88/6.12]

Blindmate Connectors (all sizes) —
x = .270 [6.86] min.

The X dimension is necessary for full mating of connector halves. This dimension must be taken into consideration when determining the method of mounting, panel thickness, etc.



AMPLIMITE Plug,
Front-Panel Mounted



AMPLIMITE Receptacle,
Rear-Panel Mounted

Attention: Front-Panel Mount

When front mounting a MIL-DTL-24308 connector utilizing the tab method of securing shell halves, it is recommended to utilize a .032 [0.81] thick washer (not supplied) to prevent deformation of connector flange.

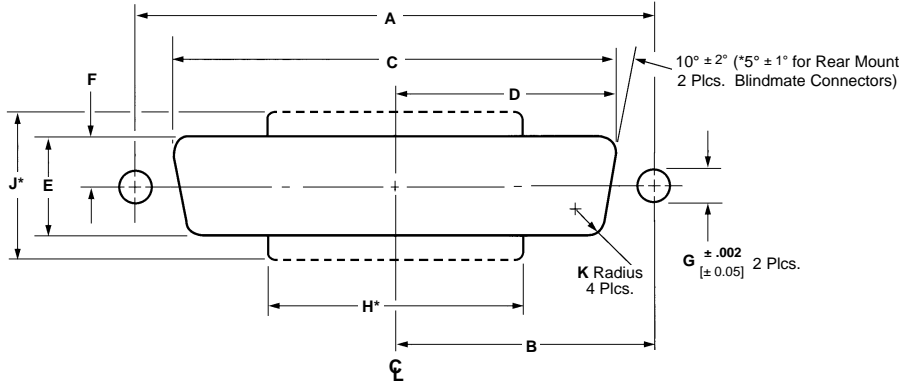

Panel Cutout

Shell Size (No. of Contact Pos.)		Mounting Method		Dimensions										
Series 109 Connectors	Series 90 Connectors	Front/Rear Panel	W/ith/Without Flouting Bushing	A	B	C	D	E	F	G	H*	J*	K	
1 (9 Pos.)	1 (15 Pos.)	Front	With	.906 23.01	.453 11.51	.545 13.84	.273 6.93	.088 2.24	—	—	—	—	.083 2.11	
			Without	.874 22.2	.437 11.1	.513 13.03	.257 6.53	.120 3.05	—	—	—	—	—	
		Rear	With	.838 21.29	.419 10.64	.481 12.22	.241 6.12	.088 2.24	.332 8.43	.662 16.81	—	—	—	.132 3.35
			Without	.806 20.47	.403 10.24	.449 11.4	.225 5.72	.120 3.05	.300 7.62	.630 16	—	—	—	—
2 (15 Pos.)	2 (26 Pos.)	Front	With	1.234 31.34	.617 15.67	.545 13.84	.273 6.93	.088 2.24	—	—	—	—	.083 2.11	
			Without	1.202 30.53	.601 15.27	.513 13.03	.257 6.53	.120 3.05	—	—	—	—	—	
		Rear	With	1.166 29.62	.583 14.81	.481 12.22	.241 6.12	.088 2.24	.665 16.81	.662 16.81	—	—	—	.132 3.35
			Without	1.134 28.8	.567 14.4	.449 11.4	.225 5.72	.120 3.05	.623 15.82	.630 16	—	—	—	—
3 (25 Pos.)	3 (44 Pos.)	Front	With	1.775 45.09	.888 22.55	.545 13.84	.273 6.93	.088 2.24	—	—	—	—	.083 2.11	
			Without	1.743 44.27	.872 22.15	.513 13.03	.257 6.53	.120 3.05	—	—	—	—	—	
		Rear	With	1.706 43.33	.853 21.67	.481 12.22	.241 6.12	.088 2.24	1.197 30.4	.662 16.81	—	—	—	.132 3.35
			Without	1.674 42.52	.837 21.26	.449 11.4	.225 5.72	.120 3.05	1.165 29.59	.630 16	—	—	—	—
4 (37 Pos.)	4 (62 Pos.)	Front	With	2.423 61.17	1.212 30.78	.545 13.84	.273 6.93	.088 2.24	—	—	—	—	.083 2.11	
			Without	2.391 60.73	1.196 30.38	.513 13.03	.257 6.53	.120 3.05	—	—	—	—	—	
		Rear	With	2.354 59.79	1.777 29.9	.481 12.22	.241 6.12	.088 2.24	1.845 46.86	.662 16.81	—	—	—	.132 3.35
			Without	2.326 59.08	1.163 29.54	.449 11.4	.225 5.72	.120 3.05	1.813 46.05	.630 16	—	—	—	—
5 (50 Pos.)	5 (78 Pos.)	Front	With	2.329 59.16	1.165 29.59	.655 16.64	.328 8.33	.088 2.24	—	—	—	—	.083 2.11	
			Without	2.297 58.34	1.149 29.18	.623 15.82	.312 7.92	.120 3.05	—	—	—	—	—	
		Rear	With	2.250 57.15	1.125 28.58	.587 14.91	.294 7.47	.088 2.24	1.740 44.2	.772 19.61	—	—	—	.132 3.35
			Without	2.218 56.34	1.109 28.17	.555 14.1	.278 7.06	.120 3.05	1.708 43.38	.740 18.8	—	—	—	—
—	6 (104 Pos.)	Front	With	2.453 62.31	1.227 31.17	.717 18.21	.359 9.12	.088 2.24	—	—	—	—	.083 2.11	
			Without	2.421 61.49	1.211 30.76	.685 17.4	.343 8.71	.120 3.05	—	—	—	—	—	
		Rear	With	2.388 60.66	1.194 30.33	.654 16.61	.327 8.31	.088 2.24	1.875 47.64	.835 21.21	—	—	—	.132 3.35
			Without	2.356 59.84	1.179 29.92	.622 5.8	.311 7.9	.120 3.05	1.843 46.81	.803 20.4	—	—	—	—

*Panel cutout configuration with these dimensions provides clearance for mounting connectors with cable clamp assemblies.

PCB Layouts—Series 109 (Standard Density)

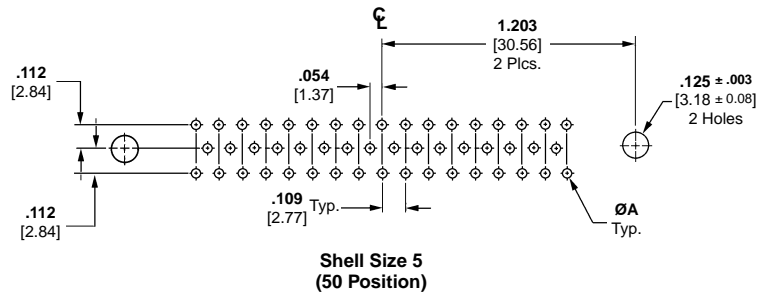
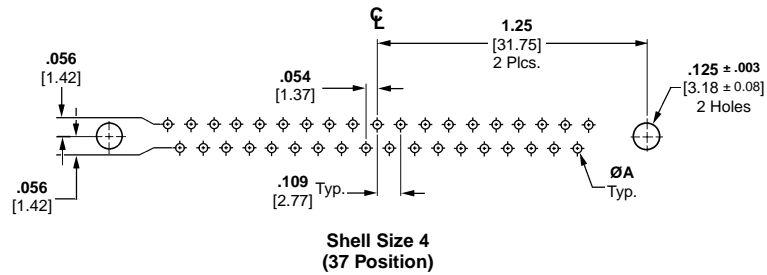
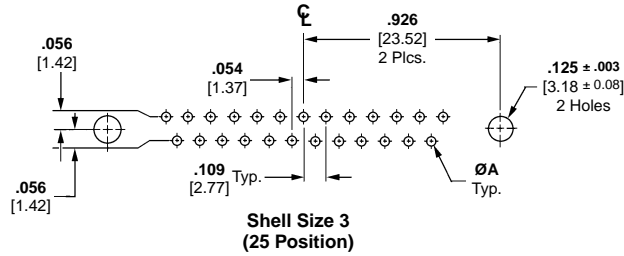
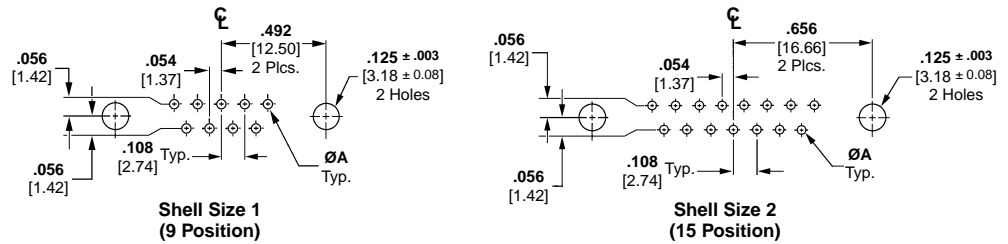

Post Diameter	ØA
.018 [0.46]	.028 [0.71] — .038 [0.96]
.025 [0.64]	.035 [0.89] — .045 [1.14]
.030 [0.76]	.040 [1.02] — .050 [1.27]
.040 [1.02]	.050 [1.27] — .060 [1.52]

- Notes:**
- Mating face of plug is shown, receptacle is mirror image.
 - PCB mounting hole diameters are provided for connectors with .120 [3.05] diameter mounting holes. For connectors with .154 [3.91] mounting holes, use PCB mounting hole diameter .160 ± .003 [4.06 ± 0.08].
 - PC layouts illustrated above serve as a guide only; they are not to be used for actual design or construction of customer equipment. Consult AMP customer print for detailed PC board layout requirements.

PCB Layouts—Series 90 (High Density)

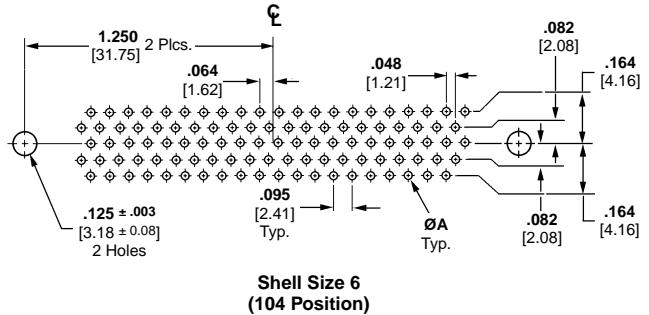
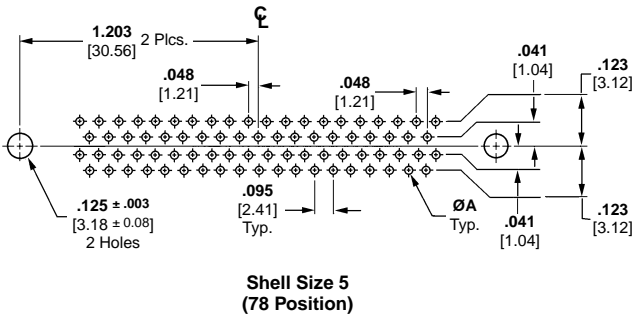
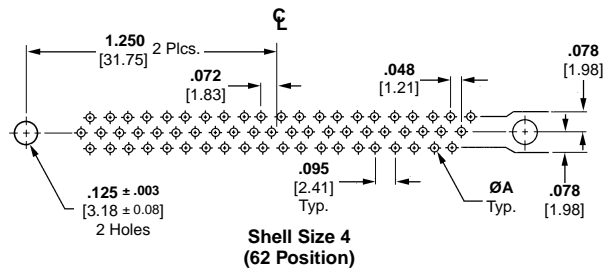
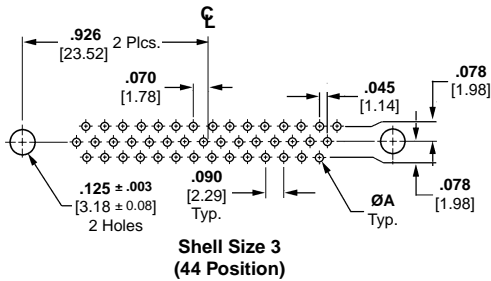
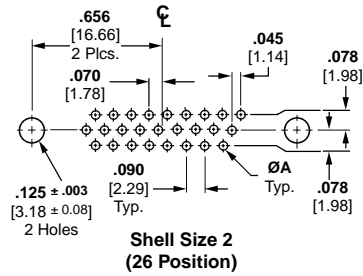
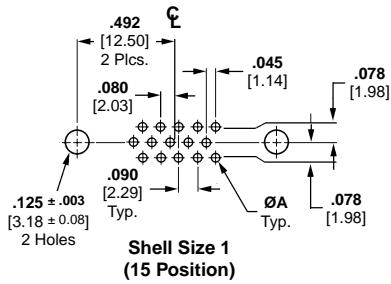

Post Diameter	ØA
.018 [0.46]	.028 [0.71] — .038 [0.96]
.025 [0.64]	.035 [0.89] — .045 [1.14]
.030 [0.76]	.040 [1.02] — .050 [1.27]
.040 [1.02]	.050 [1.27] — .060 [1.52]

- Notes:**
1. Mating face of plug is shown, receptacle is mirror image.
 2. PCB mounting hole diameters are provided for connectors with .120 [3.05] diameter mounting holes. For connectors with .154 [3.91] mounting holes, use PCB mounting hole diameter .160 ± .003 [4.06 ± 0.08].
 3. PC layouts illustrated above serve as a guide only; they are not to be used for actual design or construction of customer equipment. Consult AMP customer print for detailed PC board layout requirements.

PCB Layouts (Power/Coax/Signal)

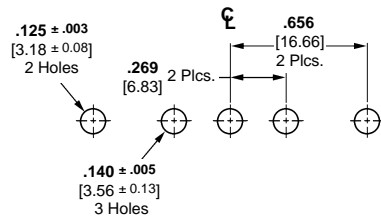

3C3

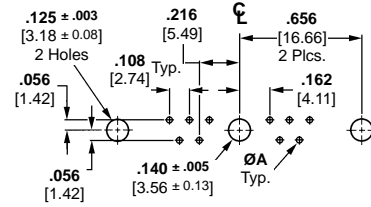

11C1

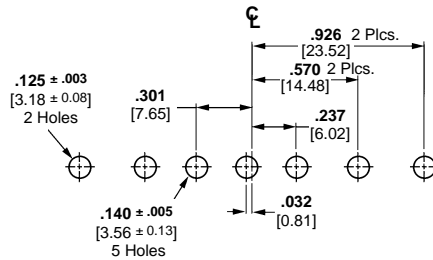

5C5

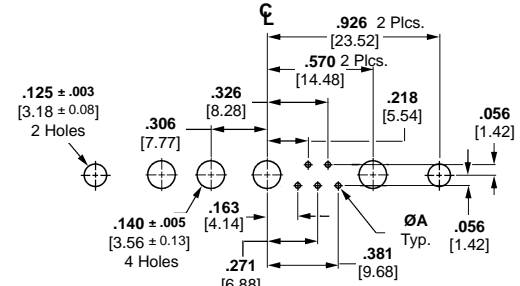

9C4

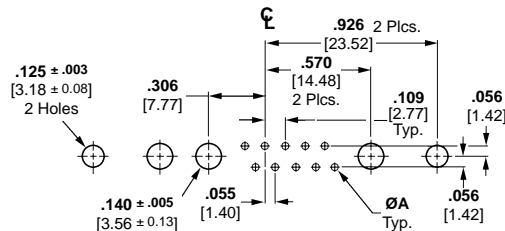

13C3

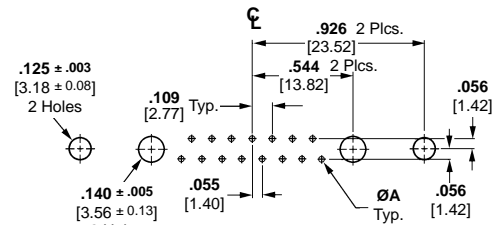

17C2

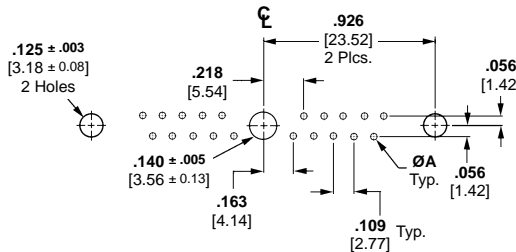

21C1

Post Diameter	ØA
.018 [0.46]	.028 [0.71] — .038 [0.96]
.025 [0.64]	.035 [0.89] — .045 [1.14]
.030 [0.76]	.040 [1.02] — .050 [1.27]
.040 [1.02]	.050 [1.27] — .060 [1.52]

- Notes:**
- Mating face of plug is shown, receptacle is mirror image.
 - PCB mounting hole diameters are provided for connectors with .120 [3.05] diameter mounting holes. For connectors with .154 [3.91] mounting holes, use PCB mounting hole diameter .160 ± .003 [4.06 ± 0.08].
 - PC layouts illustrated above serve as a guide only; they are not to be used for actual design or construction of customer equipment. Consult AMP customer print for detailed PC board layout requirements.

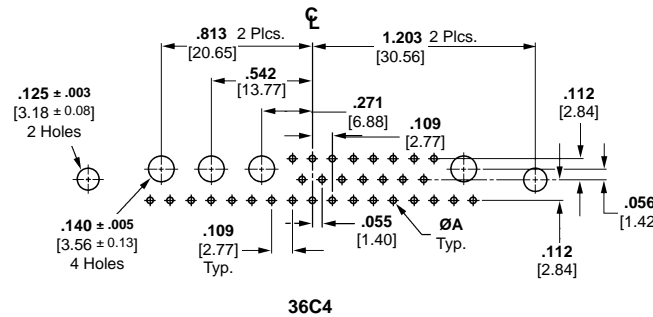
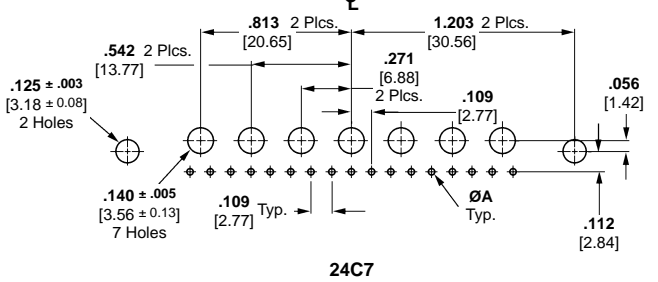
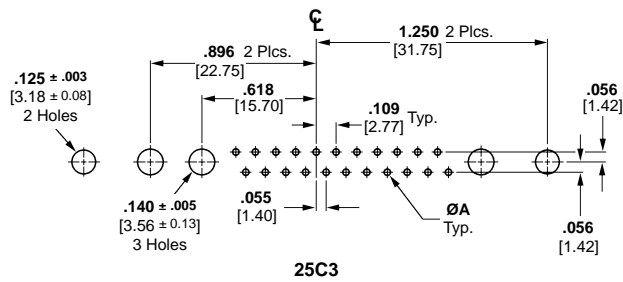
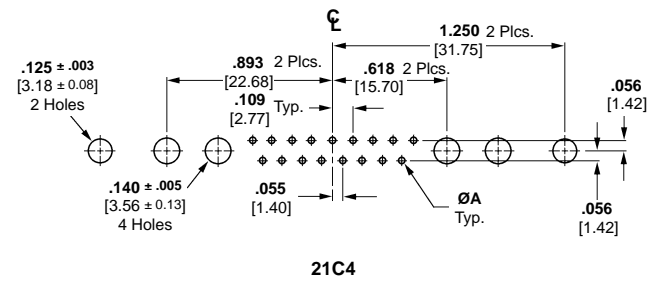
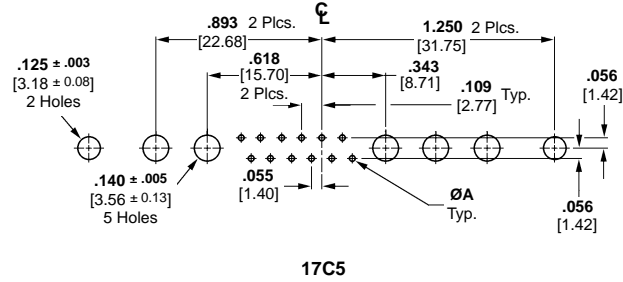
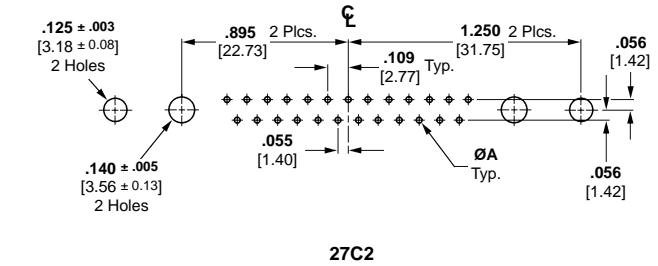
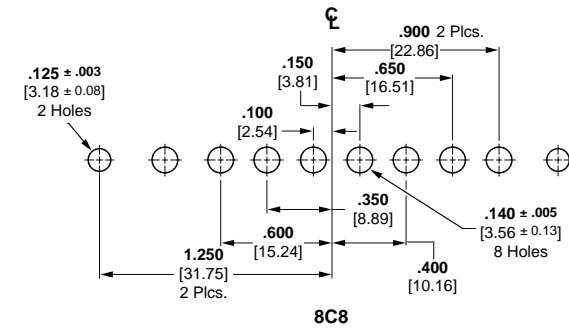

Post Diameter	ØA
.018 [0.46]	.028 [0.71] - .038 [0.96]
.025 [0.64]	.035 [0.89] - .045 [1.14]
.030 [0.76]	.040 [1.02] - .050 [1.27]
.040 [1.02]	.050 [1.27] - .060 [1.52]

- Notes:**
1. Mating face of plug is shown, receptacle is mirror image.
 2. PCB mounting hole diameters are provided for connectors with .120 [3.05] diameter mounting holes. For connectors with .154 [3.91] mounting holes, use PCB mounting hole diameter .160 ± .003 [4.06 ± 0.08].
 3. PC layouts illustrated above serve as a guide only; they are not to be used for actual design or construction of customer equipment. Consult AMP customer print for detailed PC board layout requirements.

5
Pin and Socket Connectors

Female Screwlocks for Metal-Shell Connectors

Material and Finish

Standard Steel Parts — Cold rolled steel per ASTM A108, zinc plated per ASTM B633, Type II, Class SCI

Stainless Steel — Passivated stainless steel

Technical Documents

Instruction Sheet — 408-7837

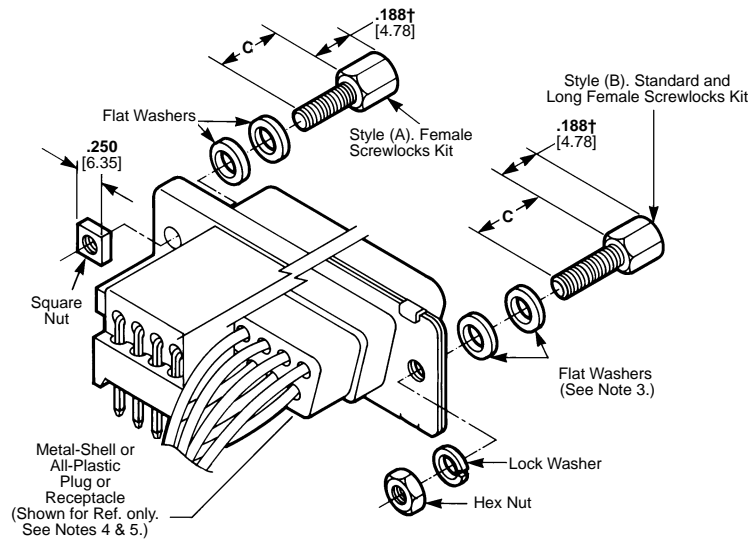

Nut Driver, Part Number 811262-1
(Used for assembling female screwlocks to connector flange)

Connector Used with	Style	Dim. C	Thread Size	Finish	Steel Kit Number		Stainless Steel	
					Individual	Bulk Packed ^a	Standard Kit	Long Special
6	(B)	.312 7.93	4-40	Yellow Chromate	205817-1	205817-2	—	—
				Clear Chromate	748271-1†	—	—	—
			M3 (Metric)	Yellow Chromate	207872-1	—	—	—
				Clear Chromate	207872-3	—	—	—
			4-40††	Yellow Chromate	206897-1	—	—	—
.090 Thick Panels†	(B)	.312 7.93	4-40	Yellow Chromate	748271-3	—	—	—
6	(B)	.312 7.93	4-40	Yellow Chromate	—	—	212447-1	—
6	(B)	.500 12.7	4-40	Yellow Chromate	—	—	—	212452-1

Individual Screwlocks

(Washers and Nuts not included)

Connector Used with	Style	Dimension C	Thread Size	Finish	Screwlocks	
					Individual	Bulk Packed ^a
6	(B)	.312 7.93	4-40	Yellow Chromate	205818-2	—
				Clear Chromate	205818-3	—
				Clear Chromate	748558-3 ^{ΔΔ}	748558-4 ^{ΔΔ}
			M2.6** (Metric)	Clear Chromate	749765-3	—
			4-40	Yellow Chromate	748270-2†	—
			M3*** (Metric)	Clear Chromate	747404-3	—
			(Special)	.185 4.70	4-40	Clear Chromate

^aEach part is individually bulk packed for multiple kit orders.

^{ΔΔ}With captivated star washer. No additional hardware included.

†Part Number 748270-2 and 748271-1 Dimension .158 [4.01]

††206897-1 kit contains 2-screwlocks, 2-hex nuts and 2-retainers.

**M2.6 is the female thread size. The male thread size is 4-40.

***M3 is the female thread size. The male thread size is 4-40.

Notes: 1. All parts are packaged unassembled.

2. Each female screwlock kit is comprised of two assemblies as illustrated above.

3. One or two flat washers may be required for panel thicknesses less than .060 [1.52]. Female screwlocks are not recommended for panel thicknesses greater than .060 [1.52].

4. Female screwlocks with 2-56 thread size are to be used with cable clamps with mounting flanges. Female screwlocks with 4-40 and M3 (Metric) thread sizes can be used with all other cable clamps.

5. Female screwlocks mate with male screw retainers (page 5149).

6. Series 90 and 109 Connectors without eyelets or floating bushings.

Male Screw Retainers for Metal-Shell Connectors

Material and Finish

Male Screw — Steel, zinc plated clear or yellow chromate

Retaining Clip — .012 [0.31] stainless steel

Technical Documents

Instruction Sheet — 408-7837

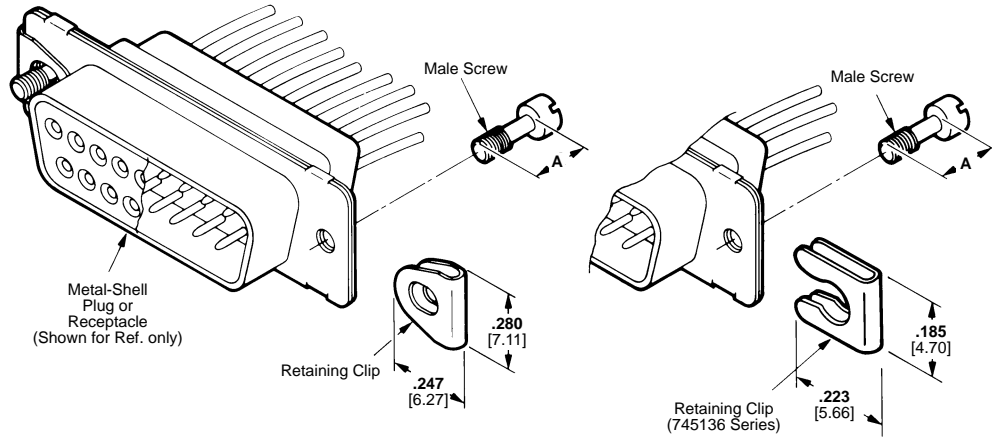

Male Screw Finish	Thread Size	Dimension A	Male Screw Retainer Kit No.	
			Individual	Bulk Packed*
Yellow Chromate	4-40	.220 5.59	205980-1	205980-3
		.200 5.08	745136-1	745136-2
	M3 (Metric)	.225 5.72	207871-1	—
	M2.6 (Metric)	.225 5.72	750035-1	—
Clear Chromate	4-40	.220 5.59	205980-4	205980-5
		.200 5.08	745136-3	745136-4

*Each part is individually bulk packed for multiple kit orders.

Notes: 1. All parts are packaged unassembled.

- Each kit is comprised of two male screws and two retaining clips. Male screw retainers are also furnished as part of cable clamp kits (pages 5148 and 5149).
- Male screw retainers mate with female screwlocks (page 5148) and with metal-shell board mount connectors featuring 4-40 threaded inserts or female screwlocks.
- Retaining clip must be assembled onto connector flanges with threaded hole toward wire side of connector.

Stainless Steel Kit

Materials

All Parts — Stainless steel, passivated per QQ-P-35B.

AMP Part Number 211883-5 or MIL Part Number M24308/25-6P

Notes:

- Each kit includes two screws and two retainers.
- Retainer is assembled onto connector flange with threaded hole toward the wire side of the connector.

Male Screw Retainer Kits

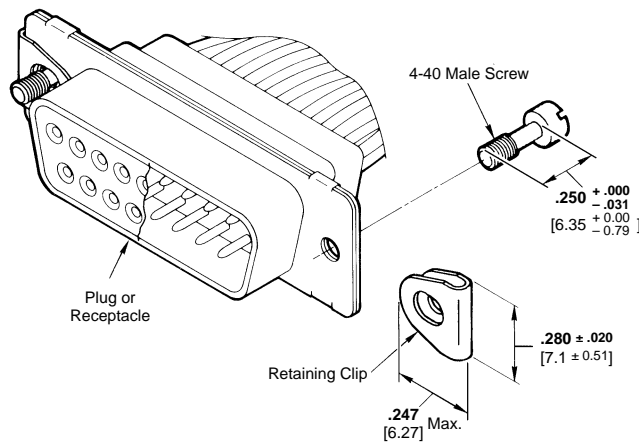

Accessories (Continued)

Standard Bushings (for Connectors with Straight Posted Contacts, PC Board Mounted)

Material
Aluminum

Kit Numbers

*Parts are individually bulk packed for multiple kit orders.

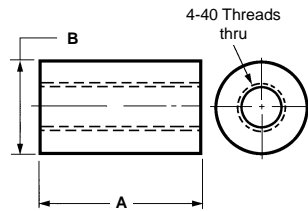

Note: Standoff Bushings are used with a plug or receptacle of PC board mounted connectors.

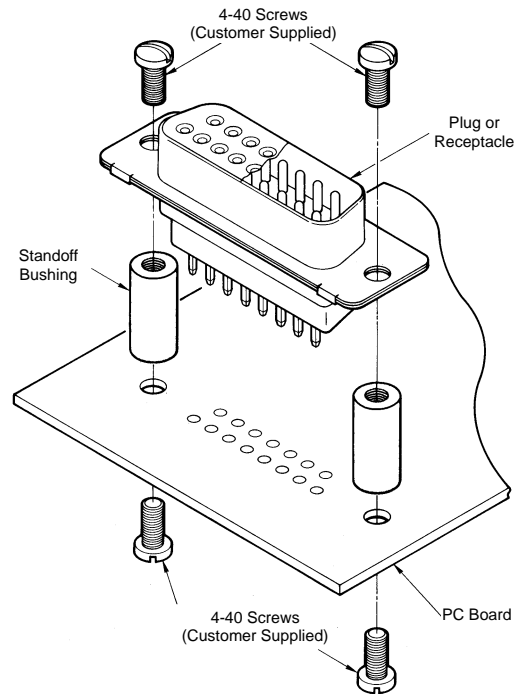

Part No.	Dim. A	Dim. B	Packaged
205933-3	.435 11.05	.250 6.35	2 Per Bag
205933-4	.435 11.05	.250 6.35	*Bulked Pack
443279-2	.246 6.25	.190 4.83	2 Per Bag
443279-3	.246 6.25	.190 4.83	*Bulk Pack

Dust Covers

Dust covers for subminiature D connectors are not manufactured by Tyco Electronics. They may be purchased from:*

Caplugs
2150 Elmwood Avenue
Buffalo, NY 14207
Phone: (716) 876-9855
Fax: (716) 874-1680

See Catalog 1307612 for additional hardware such as cable clamps, strain reliefs, etc.

Notes:

1. There are no cable clamp/strain relief hardware available for size 6 connectors.

2. Cable clamp/strain relief hardware cannot be used with the Power/Coax/Combination Product shown on pages 5122 and 5123 of this catalog.

* Caplugs is not an affiliate of Tyco Electronics.

EMI/RFI Gaskets

Material and Finish

Brass, .006 [0.15] thick;
bright tin plated

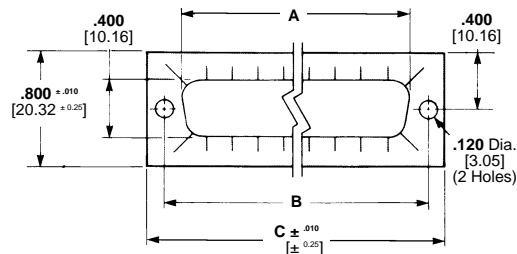

9, 15, 25 and 37 Positions

Shell Size (No. of Contact Pos.)	Dimensions			Gasket Part No.
	A	B	C	
1 (9)	.746 18.95	.984 24.99	1.220 30.99	747024-3
2 (15)	1.074 27.28	1.312 33.32	1.555 39.50	747025-3
3 (25)	1.614 41.00	1.852 47.04	2.100 53.34	745776-3
4 (37)	2.266 57.56	2.500 63.50	2.730 69.34	745777-3

MIL-DTL-24308 vs. AMP AMPLIMITE Connectors

This list is provided for reference only. In the event that a discrepancy exists between this catalog and the respective military QPL, then the QPL shall take precedence.

MILITARY PART NUMBER FOR ORDERING	MILITARY PART NUMBER ON CONNECTOR	AMP PART NUMBER FOR ORDERING	AMP PART NUMBER ON CONNECTOR	REMARKS (All connectors provided with contacts unless otherwise specified)	
/1	M24308/1-1F	M24308/1-1F	593007-1	593007-1	
	M24308/1-2F	M24308/1-2F	593007-2	593007-2	
	M24308/1-3F	M24308/1-3F	593007-3	593007-3	
	M24308/1-4F	M24308/1-4F	593007-4	593007-4	
	M24308/1-5F	M24308/1-5F	593007-5	593007-5	
	M24308/1-12F	M24308/1-12F	593008-1	593008-1	
	M24308/1-13F	M24308/1-13F	593008-2	593008-2	
	M24308/1-14F	M24308/1-14F	593008-3	593008-3	
	M24308/1-15F	M24308/1-15F	593008-4	593008-4	
	M24308/1-16F	M24308/1-16F	593008-5	593008-5	
	M24308/1-23F	M24308/1-23F	593009-1	593009-1	
	M24308/1-24F	M24308/1-24F	593009-2	593009-2	
	M24308/1-25F	M24308/1-25F	593009-3	593009-3	
	M24308/1-26F	M24308/1-26F	593009-4	593009-4	
	M24308/1-27F	M24308/1-27F	593009-5	593009-5	
/2	M24308/2-1F	M24308/2-1F	205555-2	205555-2	
	M24308/2-2F	M24308/2-2F	205557-2	205557-2	
	M24308/2-3F	M24308/2-3F	205559-2	205559-2	
	M24308/2-4F	M24308/2-4F	205561-2	205561-2	
	M24308/2-5F	M24308/2-5F	205563-2	205563-2	
	M24308/2-6F	M24308/2-1F	205555-3	205555-2	WITH TOOL
	M24308/2-7F	M24308/2-2F	205557-3	205557-2	WITH TOOL
	M24308/2-8F	M24308/2-3F	205559-3	205559-2	WITH TOOL
	M24308/2-9F	M24308/2-4F	205561-3	205561-2	WITH TOOL
	M24308/2-10F	M24308/2-5F	205563-3	205563-2	WITH TOOL
	M24308/2-11F	M24308/2-11F	204512-2	204512-2	
	M24308/2-12F	M24308/2-12F	204514-2	204514-2	
	M24308/2-13F	M24308/2-13F	204516-2	204516-2	
	M24308/2-14F	M24308/2-14F	204518-2	204518-2	
	M24308/2-15F	M24308/2-15F	204520-2	204520-2	
	M24308/2-16F	M24308/2-16F	204522-2	204522-2	
	M24308/2-17F	M24308/2-11F	204512-3	204512-2	WITH TOOL
	M24308/2-18F	M24308/2-12F	204514-3	204514-2	WITH TOOL
	M24308/2-19F	M24308/2-13F	204516-3	204516-2	WITH TOOL
	M24308/2-20F	M24308/2-14F	204518-3	204518-2	WITH TOOL
	M24308/2-21F	M24308/2-15F	204520-3	204520-2	WITH TOOL
	M24308/2-22F	M24308/2-16F	204522-3	204522-2	WITH TOOL
	M24308/2-23F	M24308/2-23F	205483-2	205483-2	
	M24308/2-24F	M24308/2-24F	205433-2	205433-2	
	M24308/2-25F	M24308/2-25F	205484-2	205484-2	
	M24308/2-26F	M24308/2-26F	205485-2	205485-2	
	M24308/2-27F	M24308/2-27F	205432-2	205432-2	
	M24308/2-28F	M24308/2-28F	204536-2	204536-2	
	M24308/2-29F	M24308/2-29F	204538-2	204538-2	
	M24308/2-30F	M24308/2-30F	204540-2	204540-2	
	M24308/2-31F	M24308/2-31F	204542-2	204542-2	
	M24308/2-32F	M24308/2-32F	204544-2	204544-2	
	M24308/2-33F	M24308/2-33F	204546-2	204546-2	
	M24308/2-281F	M24308/2-1F	205161-1	205555-2	LESS CONTACTS
	M24308/2-282F	M24308/2-2F	205163-1	205557-2	LESS CONTACTS
	M24308/2-283F	M24308/2-3F	205165-1	205559-2	LESS CONTACTS
	M24308/2-284F	M24308/2-4F	205167-1	205561-2	LESS CONTACTS
	M24308/2-285F	M24308/2-5F	205169-1	205563-2	LESS CONTACTS
	M24308/2-286F	M24308/2-11F	204500-1	204512-2	LESS CONTACTS
	M24308/2-287F	M24308/2-12F	204502-1	204514-2	LESS CONTACTS
	M24308/2-288F	M24308/2-13F	204504-1	204516-2	LESS CONTACTS
	M24308/2-289F	M24308/2-14F	204506-1	204518-2	LESS CONTACTS
	M24308/2-290F	M24308/2-15F	204508-1	204520-2	LESS CONTACTS
	M24308/2-291F	M24308/2-16F	204510-1	204522-2	LESS CONTACTS

Note: The suffix "F" on M24308 part numbers designates cadmium shell plating.

MIL-DTL-24308 vs. AMP AMPLIMITE Connectors (Continued)

MILITARY PART NUMBER FOR ORDERING	MILITARY PART NUMBER ON CONNECTOR	AMP PART NUMBER FOR ORDERING	AMP PART NUMBER ON CONNECTOR	REMARKS (All connectors provided with contacts unless otherwise specified)	
/2	M24308/2-292F	M24308/2-23F	205416-1	205483-2	LESS CONTACTS
	M24308/2-293F	M24308/2-24F	205417-1	205433-2	LESS CONTACTS
	M24308/2-294F	M24308/2-25F	205418-1	205484-2	LESS CONTACTS
	M24308/2-295F	M24308/2-26F	205419-1	205485-2	LESS CONTACTS
	M24308/2-296F	M24308/2-27F	205420-1	205432-2	LESS CONTACTS
	M24308/2-297F	M24308/2-28F	204524-1	204536-2	LESS CONTACTS
	M24308/2-298F	M24308/2-29F	204526-1	204538-2	LESS CONTACTS
	M24308/2-299F	M24308/2-30F	204528-1	204540-2	LESS CONTACTS
	M24308/2-300F	M24308/2-31F	204530-1	204542-2	LESS CONTACTS
	M24308/2-301F	M24308/2-32F	204532-1	204544-2	LESS CONTACTS
	M24308/2-302F	M24308/2-33F	204534-1	204546-2	LESS CONTACTS
	M24308/2-342F	M24308/2-342F	211525-2	211525-2	
	M24308/2-343F	M24308/2-343F	211526-2	211526-2	
	M24308/2-344F	M24308/2-344F	211527-2	211527-2	
	M24308/2-345F	M24308/2-345F	211528-2	211528-2	
	M24308/2-346F	M24308/2-346F	211529-2	211529-2	
	M24308/2-347F	M24308/2-347F	211536-2	211536-2	
	M24308/2-348F	M24308/2-348F	211537-2	211537-2	
	M24308/2-349F	M24308/2-349F	211538-2	211538-2	
	M24308/2-350F	M24308/2-350F	211539-2	211539-2	
	M24308/2-351F	M24308/2-351F	211540-2	211540-2	
	M24308/2-352F	M24308/2-352F	211541-2	211541-2	
	M24308/2-482F	M24308/2-342F	211525-1	211525-2	LESS CONTACTS
	M24308/2-483F	M24308/2-343F	211526-1	211526-2	LESS CONTACTS
	M24308/2-484F	M24308/2-344F	211527-1	211527-2	LESS CONTACTS
	M24308/2-485F	M24308/2-345F	211528-1	211528-2	LESS CONTACTS
	M24308/2-486F	M24308/2-346F	211529-1	211529-2	LESS CONTACTS
M24308/2-487F	M24308/2-347F	211536-1	211536-2	LESS CONTACTS	
M24308/2-488F	M24308/2-348F	211537-1	211537-2	LESS CONTACTS	
M24308/2-489F	M24308/2-349F	211538-1	211538-2	LESS CONTACTS	
M24308/2-490F	M24308/2-350F	211539-1	211539-2	LESS CONTACTS	
M24308/2-491F	M24308/2-351F	211540-1	211540-2	LESS CONTACTS	
M24308/2-492F	M24308/2-352F	211541-1	211541-2	LESS CONTACTS	
/3	M24308/3-1F	M24308/3-1F	593002-1	593002-1	
	M24308/3-2F	M24308/3-2F	593002-2	593002-2	
	M24308/3-3F	M24308/3-3F	593002-3	593002-3	
	M24308/3-4F	M24308/3-4F	593002-4	593002-4	
	M24308/3-5F	M24308/3-5F	593002-5	593002-5	
	M24308/3-12F	M24308/3-12F	593004-1	593004-1	
	M24308/3-13F	M24308/3-13F	593004-2	593004-2	
	M24308/3-14F	M24308/3-14F	593004-3	593004-3	
	M24308/3-15F	M24308/3-15F	593004-4	593004-4	
	M24308/3-16F	M24308/3-16F	593004-5	593004-5	
	/4	M24308/4-1F	M24308/4-1F	205556-2	205556-2
M24308/4-2F		M24308/4-2F	205558-2	205558-2	
M24308/4-3F		M24308/4-3F	205560-2	205560-2	
M24308/4-4F		M24308/4-4F	205562-2	205562-2	
M24308/4-5F		M24308/4-5F	205564-2	205564-2	
M24308/4-6F		M24308/4-1F	205556-3	205556-2	WITH TOOL
M24308/4-7F		M24308/4-2F	205558-3	205558-2	WITH TOOL
M24308/4-8F		M24308/4-3F	205560-3	205560-2	WITH TOOL
M24308/4-9F		M24308/4-4F	205562-3	205562-2	WITH TOOL
M24308/4-10F		M24308/4-5F	205564-3	205564-2	WITH TOOL
M24308/4-11F		M24308/4-11F	204513-2	204513-2	
M24308/4-12F		M24308/4-12F	204515-2	204515-2	
M24308/4-13F		M24308/4-13F	204517-2	204517-2	
M24308/4-14F		M24308/4-14F	204519-2	204519-2	
M24308/4-15F		M24308/4-15F	204521-2	204521-2	
M24308/4-16F		M24308/4-16F	204523-2	204523-2	

Note: The suffix "F" on M24308 part numbers designates cadmium shell plating.

MIL-DTL-24308 vs. AMP AMPLIMITE Connectors (Continued)

	MILITARY PART NUMBER FOR ORDERING	MILITARY PART NUMBER ON CONNECTOR	AMP PART NUMBER FOR ORDERING	AMP PART NUMBER ON CONNECTOR	REMARKS (All connectors provided with contacts unless otherwise specified)
/4	M24308/4-17F	M24308/4-11F	204513-3	204513-2	WITH TOOL
	M24308/4-18F	M24308/4-12F	204515-3	204515-2	WITH TOOL
	M24308/4-19F	M24308/4-13F	204517-3	204517-2	WITH TOOL
	M24308/4-20F	M24308/4-14F	204519-3	204519-2	WITH TOOL
	M24308/4-21F	M24308/4-15F	204521-3	204521-2	WITH TOOL
	M24308/4-22F	M24308/4-16F	204523-3	204523-2	WITH TOOL
	M24308/4-259F	M24308/4-1F	205162-1	205556-2	LESS CONTACTS
	M24308/4-260F	M24308/4-2F	205164-1	205558-2	LESS CONTACTS
	M24308/4-261F	M24308/4-3F	205166-1	205560-2	LESS CONTACTS
	M24308/4-262F	M24308/4-4F	205168-1	205562-2	LESS CONTACTS
	M24308/4-263F	M24308/4-5F	205170-1	205564-2	LESS CONTACTS
	M24308/4-264F	M24308/4-11F	204501-1	204513-2	LESS CONTACTS
	M24308/4-265F	M24308/4-12F	204503-1	204515-2	LESS CONTACTS
	M24308/4-266F	M24308/4-13F	204505-1	204517-2	LESS CONTACTS
	M24308/4-267F	M24308/4-14F	204507-1	204519-2	LESS CONTACTS
	M24308/4-268F	M24308/4-15F	204509-1	204521-2	LESS CONTACTS
	M24308/4-269F	M24308/4-16F	204511-1	204523-2	LESS CONTACTS
	M24308/4-302F	M24308/4-302F	205486-2	205486-2	
	M24308/4-303F	M24308/4-303F	205409-2	205409-2	
	M24308/4-304F	M24308/4-304F	205487-2	205487-2	
	M24308/4-305F	M24308/4-305F	205488-2	205488-2	
	M24308/4-306F	M24308/4-306F	205431-2	205431-2	
	M24308/4-307F	M24308/4-307F	204537-2	204537-2	
	M24308/4-308F	M24308/4-308F	204539-2	204539-2	
	M24308/4-309F	M24308/4-309F	204541-2	204541-2	
	M24308/4-310F	M24308/4-310F	204543-2	204543-2	
	M24308/4-311F	M24308/4-311F	204545-2	204545-2	
	M24308/4-312F	M24308/4-312F	204547-2	204547-2	
	M24308/4-324F	M24308/4-302F	205412-1	205486-2	LESS CONTACTS
	M24308/4-325F	M24308/4-303F	205408-1	205409-2	LESS CONTACTS
	M24308/4-326F	M24308/4-304F	205413-1	205487-2	LESS CONTACTS
	M24308/4-327F	M24308/4-305F	205414-1	205488-2	LESS CONTACTS
	M24308/4-328F	M24308/4-306F	205415-1	205431-2	LESS CONTACTS
	M24308/4-329F	M24308/4-307F	204525-1	204537-2	LESS CONTACTS
M24308/4-330F	M24308/4-308F	204527-1	204539-2	LESS CONTACTS	
M24308/4-331F	M24308/4-309F	204529-1	204541-2	LESS CONTACTS	
M24308/4-332F	M24308/4-310F	204531-1	204543-2	LESS CONTACTS	
M24308/4-333F	M24308/4-311F	204533-1	204545-2	LESS CONTACTS	
M24308/4-334F	M24308/4-312F	204535-1	204547-2	LESS CONTACTS	
/5	M24308/5-1F	M24308/5-1F	593036-1	593036-1	
	M24308/5-2F	M24308/5-2F	593036-2	593036-2	
	M24308/5-3F	M24308/5-3F	593036-3	593036-3	
	M24308/5-4F	M24308/5-4F	593036-4	593036-4	
	M24308/5-5F	M24308/5-5F	593036-5	593036-5	
	M24308/5-12F	M24308/5-12F	593037-1	593037-1	
	M24308/5-13F	M24308/5-13F	593037-2	593037-2	
	M24308/5-14F	M24308/5-14F	593037-3	593037-3	
	M24308/5-15F	M24308/5-15F	593037-4	593037-4	
	M24308/5-16F	M24308/5-16F	593037-5	593037-5	
	M24308/5-23F	M24308/5-23F	593038-1	593038-1	
	M24308/5-24F	M24308/5-24F	593038-2	593038-2	
	M24308/5-25F	M24308/5-25F	593038-3	593038-3	
	M24308/5-26F	M24308/5-26F	593038-4	593038-4	
	M24308/5-27F	M24308/5-27F	593038-5	593038-5	
	/23	M24308/23-1F	M24308/23-1F	443975-1	443975-1
M24308/23-2F		M24308/23-2F	443975-2	443975-2	
M24308/23-3F		M24308/23-3F	443975-3	443975-3	
M24308/23-4F		M24308/23-4F	443975-4	443975-4	
M24308/23-5F		M24308/23-5F	443975-5	443975-5	

Note: The suffix "F" on M24308 part numbers designates cadmium shell plating.

MIL-DTL-24308 vs. AMP AMPLIMITE Connectors (Continued)

MILITARY PART NUMBER FOR ORDERING	MILITARY PART NUMBER ON CONNECTOR	AMP PART NUMBER FOR ORDERING	AMP PART NUMBER ON CONNECTOR	REMARKS (All connectors provided with contacts unless otherwise specified)
/23	M24308/23-7F	M24308/23-7F	443976-1	443976-1
	M24308/23-8F	M24308/23-8F	443976-2	443976-2
	M24308/23-9F	M24308/23-9F	443976-3	443976-3
	M24308/23-10F	M24308/23-10F	443976-4	443976-4
	M24308/23-11F	M24308/23-11F	443976-5	443976-5
	M24308/23-13F	M24308/23-13F	443977-1	443977-1
	M24308/23-14F	M24308/23-14F	443977-2	443977-2
	M24308/23-15F	M24308/23-15F	443977-3	443977-3
	M24308/23-16F	M24308/23-16F	443977-4	443977-4
	M24308/23-17F	M24308/23-17F	443977-5	443977-5
	M24308/23-19F	M24308/23-19F	443978-1	443978-1
	M24308/23-20F	M24308/23-20F	443978-2	443978-2
	M24308/23-21F	M24308/23-21F	443978-3	443978-3
	M24308/23-22F	M24308/23-22F	443978-4	443978-4
	M24308/23-23F	M24308/23-23F	443978-5	443978-5
	M24308/23-31F	M24308/23-31F	1218408-1	1218408-1
	M24308/23-32F	M24308/23-32F	1218408-2	1218408-2
	M24308/23-33F	M24308/23-33F	1218408-3	1218408-3
	M24308/23-34F	M24308/23-34F	1218408-4	1218408-4
	M24308/23-35F	M24308/23-35F	1218408-5	1218408-5
/24	M24308/24-1F	M24308/24-1F	1218124-1	1218124-1
	M24308/24-2F	M24308/24-2F	1218124-2	1218124-2
	M24308/24-3F	M24308/24-3F	1218124-3	1218124-3
	M24308/24-4F	M24308/24-4F	1218124-4	1218124-4
	M24308/24-5F	M24308/24-5F	1218124-5	1218124-5
	M24308/24-7F	M24308/24-7F	1218125-1	1218125-1
	M24308/24-8F	M24308/24-8F	1218125-2	1218125-2
	M24308/24-9F	M24308/24-9F	1218125-3	1218125-3
	M24308/24-10F	M24308/24-10F	1218125-4	1218125-4
	M24308/24-11F	M24308/24-11F	1218125-5	1218125-5
	M24308/24-13F	M24308/24-13F	1218126-1	1218126-1
	M24308/24-14F	M24308/24-14F	1218126-2	1218126-2
	M24308/24-15F	M24308/24-15F	1218126-3	1218126-3
	M24308/24-16F	M24308/24-16F	1218126-4	1218126-4
	M24308/24-17F	M24308/24-17F	1218126-5	1218126-5
	M24308/24-19F	M24308/24-19F	1218127-1	1218127-1
	M24308/24-20F	M24308/24-20F	1218127-2	1218127-2
	M24308/24-21F	M24308/24-21F	1218127-3	1218127-3
	M24308/24-22F	M24308/24-22F	1218127-4	1218127-4
	M24308/24-23F	M24308/24-23F	1218127-5	1218127-5
	M24308/24-25F	M24308/24-25F	1218440-1	1218440-1
	M24308/24-26F	M24308/24-26F	1218440-2	1218440-2
	M24308/24-27F	M24308/24-27F	1218440-3	1218440-3
	M24308/24-28F	M24308/24-28F	1218440-4	1218440-4
	M24308/24-29F	M24308/24-29F	1218440-5	1218440-5
	M24308/24-31F	M24308/24-31F	1218441-1	1218441-1
	M24308/24-32F	M24308/24-32F	1218441-2	1218441-2
	M24308/24-33F	M24308/24-33F	1218441-3	1218441-3
	M24308/24-34F	M24308/24-34F	1218441-4	1218441-4
	M24308/24-35F	M24308/24-35F	1218441-5	1218441-5
	M24308/24-37F	M24308/24-37F	1218442-1	1218442-1
	M24308/24-38F	M24308/24-38F	1218442-2	1218442-2
	M24308/24-39F	M24308/24-39F	1218442-3	1218442-3
	M24308/24-40F	M24308/24-40F	1218442-4	1218442-4
	M24308/24-41F	M24308/24-41F	1218442-5	1218442-5
	M24308/24-43F	M24308/24-43F	1218443-1	1218443-1
	M24308/24-44F	M24308/24-44F	1218443-2	1218443-2
	M24308/24-45F	M24308/24-45F	1218443-3	1218443-3
	M24308/24-46F	M24308/24-46F	1218443-4	1218443-4
	M24308/24-47F	M24308/24-47F	1218443-5	1218443-5

Note: The suffix "F" on M24308 part numbers designates cadmium shell plating.

MIL-DTL-24308 vs. AMP AMPLIMITE Connectors (Continued)

MILITARY PART NUMBER FOR ORDERING	MILITARY PART NUMBER ON CONNECTOR	AMP PART NUMBER FOR ORDERING	AMP PART NUMBER ON CONNECTOR	REMARKS (All connectors provided with contacts unless otherwise specified)	
/24	M24308/24-49F	M24308/24-49F	1218444-1	1218444-1	
	M24308/24-50F	M24308/24-50F	1218444-2	1218444-2	
	M24308/24-51F	M24308/24-51F	1218444-3	1218444-3	
	M24308/24-52F	M24308/24-52F	1218444-4	1218444-4	
	M24308/24-53F	M24308/24-53F	1218444-5	1218444-5	
	M24308/24-55F	M24308/24-55F	1218445-1	1218445-1	
	M24308/24-56F	M24308/24-56F	1218445-2	1218445-2	
	M24308/24-57F	M24308/24-57F	1218445-3	1218445-3	
	M24308/24-58F	M24308/24-58F	1218445-4	1218445-4	
	M24308/24-59F	M24308/24-59F	1218445-5	1218445-5	
	M24308/23-25F	M24308/23-25F	1218434-1	1218434-1	
	M24308/23-26F	M24308/23-26F	1218434-2	1218434-2	
	M24308/23-27F	M24308/23-27F	1218434-3	1218434-3	
	M24308/23-28F	M24308/23-28F	1218434-4	1218434-4	
	M24308/23-29F	M24308/23-29F	1218434-5	1218434-5	
	M24308/23-37F	M24308/23-37F	1218435-1	1218435-1	
	M24308/23-38F	M24308/23-38F	1218435-2	1218435-2	
	M24308/23-39F	M24308/23-39F	1218435-3	1218435-3	
	M24308/23-40F	M24308/23-40F	1218435-4	1218435-4	
	M24308/23-41F	M24308/23-41F	1218435-5	1218435-5	
	M24308/23-43F	M24308/23-43F	1218436-1	1218436-1	
	M24308/23-44F	M24308/23-44F	1218436-2	1218436-2	
	M24308/23-45F	M24308/23-45F	1218436-3	1218436-3	
	M24308/23-46F	M24308/23-46F	1218436-4	1218436-4	
	M24308/23-47F	M24308/23-47F	1218436-5	1218436-5	
	M24308/23-49F	M24308/23-49F	1218437-1	1218437-1	
	M24308/23-50F	M24308/23-50F	1218437-2	1218437-2	
	M24308/23-51F	M24308/23-51F	1218437-3	1218437-3	
	M24308/23-52F	M24308/23-52F	1218437-4	1218437-4	
	M24308/23-53F	M24308/23-53F	1218437-5	1218437-5	
	M24308/23-55F	M24308/23-55F	1218438-1	1218438-1	
	M24308/23-56F	M24308/23-56F	1218438-2	1218438-2	
	M24308/23-57F	M24308/23-57F	1218438-3	1218438-3	
	M24308/23-58F	M24308/23-58F	1218438-4	1218438-4	
	M24308/23-59F	M24308/23-59F	1218438-5	1218438-5	
/25	M24308/25-6P	—	211883-5	—	Male screw retainer kit
/26	M24308/26-1P	—	212447-1	—	Female screwlock kit
	M24308/26-1	—	205817-8	—	Female screwlock kit

Note: The suffix "F" on M24308 part numbers designates cadmium shell plating.
The suffix "P" designates passivated stainless steel.

5
Pin and Socket Connectors

M39029, M22520 and M81969 vs. AMP AMPLIMITE Connectors

MILITARY PART NUMBER FOR ORDERING	AMP PART NUMBER FOR ORDERING	REMARKS (All connectors provided with contacts unless otherwise specified)
M39029/57-354	204351-1	Size 22 Socket
M39029/58-360	204370-2	Size 22 Pin
M39029/63-368	205090-1	Size 20 Socket
M39029/64-369	205089-1	Size 20 Pin
M22520/2-01	601966-1	Crimp Tool
M22520/2-06	601966-4	Size 22 Socket Positioner
M22520/2-08	601966-5	Size 20 Positioner
M22520/2-09	601966-6	Size 22 Pin Positioner
M81969/1-02	91067-2	Size 20 Ins/Ext Tool
M81969/1-04	91067-1	Size 22 Ins/Ext Tool

NASA Power/Coax/Signal Combination vs. AMP AMPLIMITE Connectors

AMP PART NUMBER	ASSEMBLY NASA P/N 311-P-4/	DESCRIPTION
448153-2	05-7P-B-12	PLUG,3C3,NON-MAG.,120 MTG HOLE
448153-3	05-7P-B-15	PLUG,3C3,NON-MAG.,154 MTG HOLE
448154-2	05-8P-B-12	PLUG,7C2,NON-MAG.,120 MTG HOLE
448154-3	05-8P-B-15	PLUG,7C2,NON-MAG.,154 MTG HOLE
211111-2	05-9P-B-12	PLUG,11C1,NON-MAG.,120 MTG HOLE
211111-3	05-9P-B-15	PLUG,11C1,NON-MAG.,154 MTG HOLE
212491-6	05-10P-B-12	PLUG,5C5,NON-MAG.,120 MTG HOLE
212491-7	05-10P-B-15	PLUG,5C5,NON-MAG.,154 MTG HOLE
212498-2	05-11P-B-12	PLUG,9C4,NON-MAG.,120 MTG HOLE
212498-3	05-11P-B-15	PLUG,9C4,NON-MAG.,154 MTG HOLE
208810-3	05-12P-B-12	PLUG,13C3,NON-MAG.,120 MTG HOLE
208810-4	05-12P-B-15	PLUG,13C3,NON-MAG.,154 MTG HOLE
212506-2	05-13P-B-12	PLUG,17C2,NON-MAG.,120 MTG HOLE
212506-4	05-13P-B-15	PLUG,17C2,NON-MAG.,154 MTG HOLE
212522-3	05-14P-B-12	PLUG,21C1,NON-MAG.,120 MTG HOLE
212522-4	05-14P-B-15	PLUG,21C1,NON-MAG.,154 MTG HOLE
446405-2	05-15P-B-12	PLUG,8C8,NON-MAG.,120 MTG HOLE
446405-3	05-15P-B-15	PLUG,8C8,NON-MAG.,154 MTG HOLE
212514-3	05-17P-B-12	PLUG,17C5,NON-MAG.,120 MTG HOLE
212514-4	05-17P-B-15	PLUG,17C5,NON-MAG.,154 MTG HOLE
212530-2	05-18P-B-12	PLUG,21C4,NON-MAG.,120 MTG HOLE
212530-3	05-18P-B-15	PLUG,21C4,NON-MAG.,154 MTG HOLE
208742-2	05-20P-B-12	PLUG,25C3,NON-MAG.,120 MTG HOLE
208742-3	05-20P-B-15	PLUG,25C3,NON-MAG.,154 MTG HOLE
212538-2	05-21P-B-12	PLUG,27C2,NON-MAG.,120 MTG HOLE
212538-3	05-21P-B-15	PLUG,27C2,NON-MAG.,154 MTG HOLE
208743-2	05-22P-B-12	PLUG,24C7,NON-MAG.,120 MTG HOLE
208743-6	05-22P-B-15	PLUG,24C7,NON-MAG.,154 MTG HOLE
208744-3	05-23P-B-12	PLUG,36C4,NON-MAG.,120 MTG HOLE
208744-4	05-23P-B-15	PLUG,36C4,NON-MAG.,154 MTG HOLE
445705-2	05-7S-B-12	RECPT,3C3,NON-MAG.,120 MTG HOLE
445705-3	05-7S-B-15	RECPT,3C3,NON-MAG.,154 MTG HOLE
211112-2	05-9S-B-12	RECPT,11C1,NON-MAG.,120 MTG HOLE
211112-3	05-9S-B-15	RECPT,11C1,NON-MAG.,154 MTG HOLE
212059-2	05-10S-B-12	RECPT,5C5,NON-MAG.,120 MTG HOLE
212059-6	05-10S-B-15	RECPT,5C5,NON-MAG.,154 MTG HOLE
212502-2	05-11S-B-12	RECPT,9C4,NON-MAG.,120 MTG HOLE
212502-3	05-11S-B-15	RECPT,9C4,NON-MAG.,154 MTG HOLE
208811-3	05-12S-B-12	RECPT,13C3,NON-MAG.,120 MTG HOLE
208811-4	05-12S-B-15	RECPT,13C3,NON-MAG.,154 MTG HOLE
212510-2	05-13S-B-12	RECPT,17C2,NON-MAG.,120 MTG HOLE
212510-3	05-13S-B-15	RECPT,17C2,NON-MAG.,154 MTG HOLE
212526-3	05-14S-B-12	RECPT,21C1,NON-MAG.,120 MTG HOLE
212526-4	05-14S-B-15	RECPT,21C1,NON-MAG.,154 MTG HOLE
445730-3	05-15S-B-12	RECPT,8C8,NON-MAG.,120 MTG HOLE
445730-4	05-15S-B-15	RECPT,8C8,NON-MAG.,154 MTG HOLE
212518-3	05-17S-B-12	RECPT,17C5,NON-MAG.,120 MTG HOLE
212518-4	05-17S-B-15	RECPT,17C5,NON-MAG.,154 MTG HOLE
212534-2	05-18S-B-12	RECPT,21C4,NON-MAG.,120 MTG HOLE
212534-3	05-18S-B-15	RECPT,21C4,NON-MAG.,154 MTG HOLE
208551-2	05-20S-B-12	RECPT,25C3,NON-MAG.,120 MTG HOLE
208551-3	05-20S-B-15	RECPT,25C3,NON-MAG.,154 MTG HOLE
212542-2	05-21S-B-12	RECPT,27C2,NON-MAG.,120 MTG HOLE
212542-3	05-21S-B-15	RECPT,27C2,NON-MAG.,154 MTG HOLE
208552-2	05-22S-B-12	RECPT,24C7,NON-MAG.,120 MTG HOLE
208552-5	05-22S-B-15	RECPT,24C7,NON-MAG.,154 MTG HOLE
208550-2	05-23S-B-12	RECPT,36C4,NON-MAG.,120 MTG HOLE
208550-3	05-23S-B-15	RECPT,36C4,NON-MAG.,154 MTG HOLE

NASA Series 109 and 90 vs. AMP AMPLIMITE Connectors

NASA PART NUMBER FOR ORDERING	NASA PART NUMBER ON CONNECTOR	AMP PART NUMBER FOR ORDERING	AMP PART NUMBER ON CONNECTOR	REMARKS (All connectors provided with contacts unless otherwise specified)
311P407-1P-B-15	311P407-1P-B-15	206498-1	206498-1	LESS CONTACTS
311P407-1P-B-12	311P407-1P-B-12	206498-4	206498-4	LESS CONTACTS
311P407-2P-B-15	311P407-2P-B-15	206500-1	206500-1	LESS CONTACTS
311P407-2P-B-12	311P407-2P-B-12	206500-4	206500-4	LESS CONTACTS
311P407-3P-B-15	311P407-3P-B-15	206063-2	206063-2	LESS CONTACTS
311P407-3P-B-12	311P407-3P-B-12	206063-4	206063-4	LESS CONTACTS
311P407-4P-B-15	311P407-4P-B-15	206502-1	206502-1	LESS CONTACTS
311P407-4P-B-12	311P407-4P-B-12	206502-4	206502-4	LESS CONTACTS
311P407-5P-B-15	311P407-5P-B-15	206504-1	206504-1	LESS CONTACTS
311P407-5P-B-12	311P407-5P-B-12	206504-4	206504-4	LESS CONTACTS
311P407-6P-B-15	311P407-6P-B-15	206066-2	206066-2	LESS CONTACTS
311P407-6P-B-12	311P407-6P-B-12	206066-4	206066-4	LESS CONTACTS
311P407-1S-B-15	311P407-1S-B-15	206499-1	206499-1	LESS CONTACTS
311P407-1S-B-12	311P407-1S-B-12	206499-4	206499-4	LESS CONTACTS
311P407-2S-B-15	311P407-2S-B-15	206501-1	206501-1	LESS CONTACTS
311P407-2S-B-12	311P407-2S-B-12	206501-4	206501-4	LESS CONTACTS
311P407-3S-B-15	311P407-3S-B-15	206064-2	206064-2	LESS CONTACTS
311P407-3S-B-12	311P407-3S-B-12	206064-4	206064-4	LESS CONTACTS
311P407-4S-B-15	311P407-4S-B-15	206503-1	206503-1	LESS CONTACTS
311P407-4S-B-12	311P407-4S-B-12	206503-4	206503-4	LESS CONTACTS
311P407-5S-B-15	311P407-5S-B-15	206505-1	206505-1	LESS CONTACTS
311P407-5S-B-12	311P407-5S-B-12	206505-4	206505-4	LESS CONTACTS
311P407-6S-B-15	311P407-6S-B-15	206065-2	206065-2	LESS CONTACTS
311P407-6S-B-12	311P407-6S-B-12	206065-4	206065-4	LESS CONTACTS
311P409-1P-B-15	311P409-1P-B-15	207252-1	207252-1	LESS CONTACTS
311P409-1P-B-12	311P409-1P-B-12	207252-2	207252-2	LESS CONTACTS
311P409-2P-B-15	311P409-2P-B-15	206798-1	206798-1	LESS CONTACTS
311P409-2P-B-12	311P409-2P-B-12	206798-2	206798-2	LESS CONTACTS
311P409-3P-B-15	311P409-3P-B-15	206800-1	206800-1	LESS CONTACTS
311P409-3P-B-12	311P409-3P-B-12	206800-2	206800-2	LESS CONTACTS
311P409-4P-B-15	311P409-4P-B-15	206802-1	206802-1	LESS CONTACTS
311P409-4P-B-12	311P409-4P-B-12	206802-2	206802-2	LESS CONTACTS
311P409-5P-B-15	311P409-5P-B-15	206804-1	206804-1	LESS CONTACTS
311P409-5P-B-12	311P409-5P-B-12	206804-2	206804-2	LESS CONTACTS
311P409-1S-B-15	311P409-1S-B-15	207253-1	207253-1	LESS CONTACTS
311P409-1S-B-12	311P409-1S-B-12	207253-2	207253-2	LESS CONTACTS
311P409-2S-B-15	311P409-2S-B-15	206799-1	206799-1	LESS CONTACTS
311P409-2S-B-12	311P409-2S-B-12	206799-2	206799-2	LESS CONTACTS
311P409-3S-B-15	311P409-3S-B-15	206801-1	206801-1	LESS CONTACTS
311P409-3S-B-12	311P409-3S-B-12	206801-2	206801-2	LESS CONTACTS
311P409-4S-B-15	311P409-4S-B-15	206803-1	206803-1	LESS CONTACTS
311P409-4S-B-12	311P409-4S-B-12	206803-2	206803-2	LESS CONTACTS
311P409-5S-B-15	311P409-5S-B-15	206805-1	206805-1	LESS CONTACTS
311P409-5S-B-12	311P409-5S-B-12	206805-2	206805-2	LESS CONTACTS
G-08-P1		204370-8		SIZE 22 PIN
G-08-S1		206071-1		SIZE 22 SOCKET
G-10-P1		205089-4		SIZE 20 PIN
G-10-S1		206793-1		SIZE 20 SOCKET

5 Pin and Socket Connectors

Introduction

Product Facts

- **Modular versatility with Multimate contact capabilities permit multiple combinations of power, signal, coaxial and fiber optic circuits in one basic connector configuration**
- **Choice of shell sizes for housing one, two or three contact modules**
- **Modules available accommodating various circuit arrangements**
- **Polarized shells, with and without floating bushings**
- **Machine-applied terminations provide high production rates at low applied cost**
- **Recognized under the Component Program of Underwriters Laboratories Inc., File No. E28476**
- **Certified by Canadian Standards Association, File No. LR 7189**



AMP G Series connectors provide a practical means of mixing various types of electrical circuits in one basic connector configuration. They offer modular versatility as well as Multimate contact capabilities which permit use of multiple combinations of power, signal, coaxial and fiber optic circuits in the same connectors.

The "G" Series connector line provides a choice of shell sizes for housing either one, two, or three

contact modules. The modules, in turn, are available in a variety of circuit densities to accommodate Type XII power contacts; Size 12 Type I and miniature COAXICON contacts (interchangeable in the same contact cavity); and Size 16 Type II, III+, VI, X, subminiature COAXICON contacts.

Each shell includes a retainer plate for easy drop-in assembly of the contact modules. Both shell and retainer are made of cast

aluminum. Shells also are available with and without floating bushings and are polarized with keyways in the receptacles and matching keys in the plugs. The modules are made of either diallyl phthalate or general purpose phenolic.

Complementing the "G" Series modular connectors are latching hardware, cable clamps and strain relief which ensure the integrity of all mated connections.

Technical Documents

The following is a list of technical documents covering the application, performance and maintenance of "G" Series Connectors.

Product Specifications describe technical performance characteristics and verification tests. They are intended for the Design, Component and Quality Engineer.

108-10002 — AMP G Series Connectors

108-10037 — Type XII Contacts

Instruction Sheets provide instructions for assembling or applying the product. They are intended for the Manufacturing Assembler or Operator.

Product —

Connectors, Contacts and Accessories — 408-7171, 408-7184, 408-7189, 408-7190, 408-7230

Locking Latch — 408-7268

Locking Spring — 408-7187

Cable Clamps — 408-7185

Strain Relief — 408-7186, 408-7263

Tooling —

Crimping Dies:

Type I Contacts 1 — 408-7225

Type II Contacts — 408-7420, 408-7453

Type XII Contacts — 408-7175

Miniature COAXICON Contacts — 408-1770

Hand Crimping:

Type I Contacts — 408-7192

Type II Contacts — 408-6810, 408-1786, 408-7267

Type III+ Contacts — 408-7414, 408-9819

Type VI Contacts — 408-9819, 408-7680, 408-7716

Type XII Contacts — 408-2095

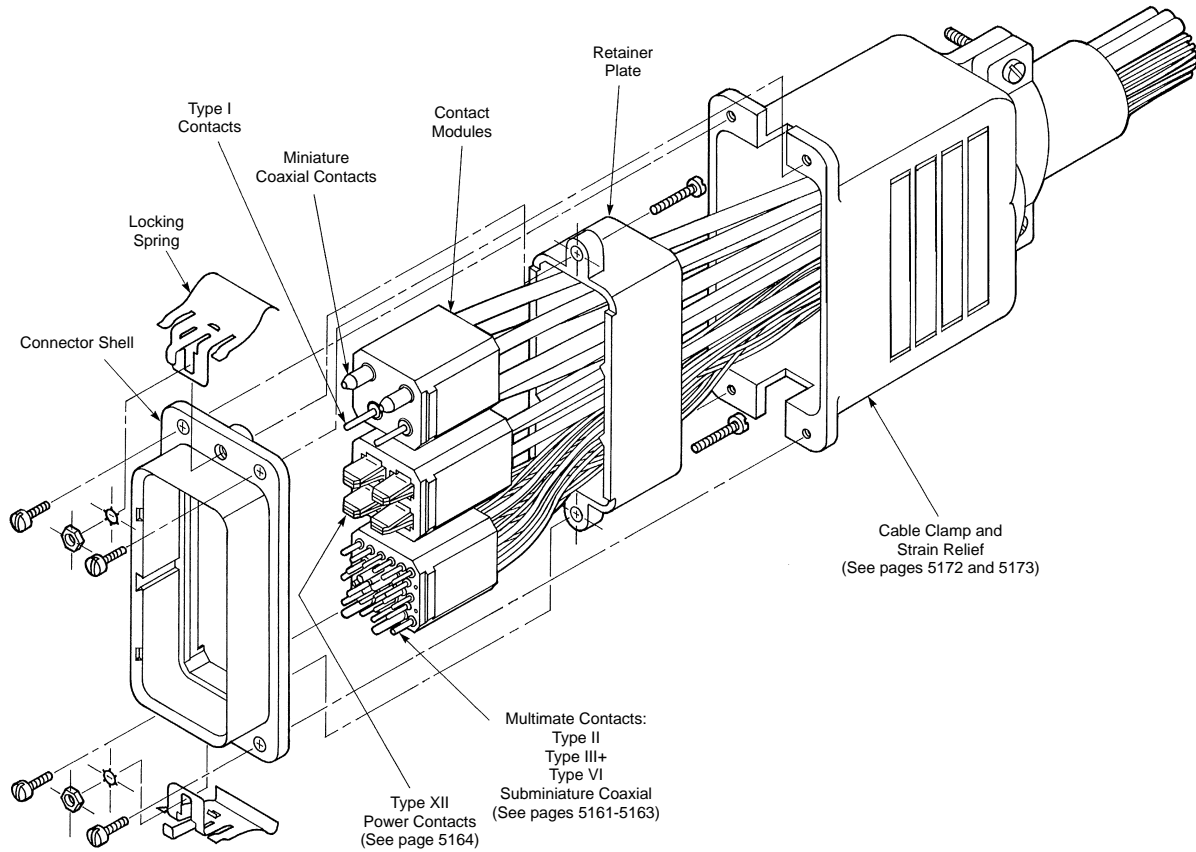

Contact Current Carrying Capability

The total current capacity of each contact is dependent upon the heat rise resulting from the combination of electrical loads on all the contacts in the connector arrangement and the maximum ambient temperature in which the connector will be operating. Caution must be taken to assure that these combinations of conditions do not cause the internal temperature of the connector to exceed the maximum operating temperature of the housing material. There are several variables which must be considered when determining the maximum current capability of your application.

These variables are:

- a) Wire Size — Larger wire will carry more current since it has less internal resistance to current flow and generates less heat. The wire also conducts heat away from the connector.
- b) Connector Size — In general, the more circuits in a connector, the less current per contact can be carried.
- c) Ambient Temperature — The higher the ambient temperature, the less current can be carried.

Contact Modules

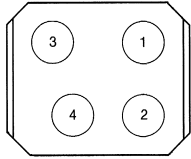

4 Position
(Type I and/or Miniature COAXICON Contacts)

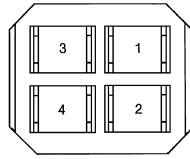

4 Position
(Type XII Power Contacts)

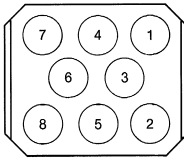

8 Position
(Type I and/or Miniature COAXICON Contacts)

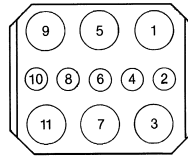

11 Position
(Type I and/or Miniature COAXICON Contacts and Multimate Contacts)

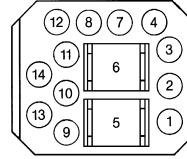

14 Position
(Type XII and Multimate Contacts)

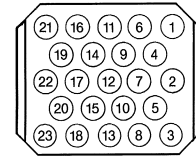

23 Position
(Multimate Contacts)

Note: Mating face of Pin Module shown. Socket Module is mirror image.

No. of Positions	Module Will Accommodate These Contact Variations†	Part Numbers			
		Phenolic		Diallyl Phthalate	
		Pin Module	Socket Module	Pin Module	Socket Module
4	4 Type XII Contacts	202624-2	202625-2	—	—
4	4 Miniature COAXICON Contacts or Type I (Size 12) Contacts	—	—	213092-2	213093-2
8	8 Any combination of Miniature COAXICON Contacts and Type I (Size 12) Contacts	—	—	213090-4* 213090-2	213091-4* 213091-2
11	6 Miniature COAXICON Contacts or Type I (Size 12) Contacts and 5 Type II (Size 16), Type III+ (Size 16), Type VI (Size 16) or Subminiature COAXICON Contacts	202648-4	202649-4	202648-2	202649-2
14	2 Type XII Contacts and 12 Type II (Size 16), Type III+ (Size 16), Type VI (Size 16), or Subminiature COAXICON Contacts	202759-2	202760-2	202759-4	202760-4
23	23 Type II (Size 16), Type III+ (Size 16), Type VI (Size 16) or Subminiature COAXICON Contacts	202650-4	202651-4	202650-2	202651-2

*Type I contacts cannot be used in cavities 1, 2, 7 and 8.
†Order contacts separately, see below and pages 5163-5166.

Multimate Contacts

Type I Contacts

Contact size — 12
Pin diameter — .094 [2.39]
Test current — 23 amperes*

Materials:

Contact Body — Copper alloy
Spring — Stainless steel
Finish — .000030 [0.00076] gold over .000030 [0.00076] nickel

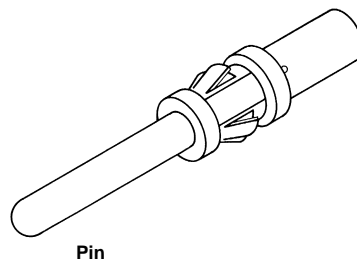

Pin

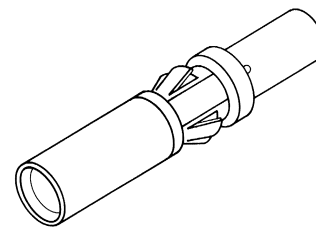

Socket

*Note: Current carrying capability depends on wire size, connector size and ambient temperature.

Wire Size Range AWG	Wire Strip Length [mm ²]	Wire Strip Length	Ins. Dia. Range	Loose Piece Contact Part No.		Tooling Part Number	
				Pin	Socket	Hand Tool	Dies for Pneumatic Tool 69365
18-16	0.8-1.4	.234 5.95	No Ins. Support	202421-1	202418-1	90121	90122
14-12	2-3	.234 5.95	No Ins. Support	202422-1	202417-1		

Extraction Tool Part Number 305183-8.

Signal Contacts

Type II, Screw Machined, Crimp

Material

Contact Body — Brass

Retention Spring — Stainless steel

Finish

Contact Body — 000030 [0.00076] gold over .000050 [0.00127] nickel. Gold thickness controlled on socket O.D.

Retention Spring — Stainless steel



Pin

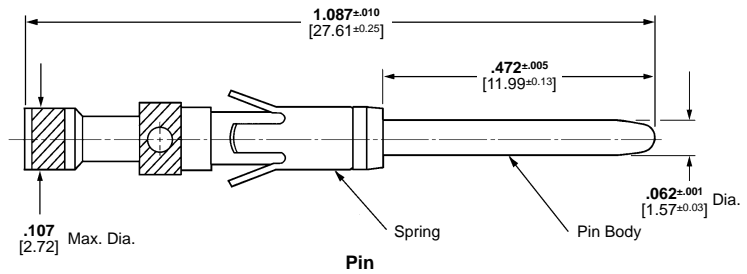

Socket

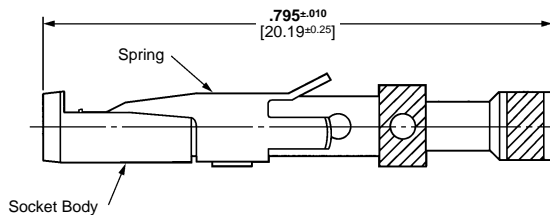

Socket

Contact Size 16—Pin Diameter .062 [1.57] (Test Current, 13 Ampere)‡

Wire Size Range	Ins. Dia. Range ¹	Tape Mounted Contact No. ²		Loose Piece Contact No.		Contact Color Code	Tooling Part No.			
		Pin	Socket	Pin	Socket		Tape Mounted Dies for AMP-TAPETRONIC Machine 69875	Loose Piece Die Set for 626 Pneumatic Tool System	Hand Tool	
28-24	0.08-0.20	.035-.055 0.89-1.40	201611-4	—	201611-1 ⁴	201613-1 ⁵	Red/Red	90249-2	90230-1 ⁷	91538-1 or 601967-1
			—	—	201334-1 ⁴	201332-1 ⁵				Red/Red
			—	—	202410-1 ⁴	202411-1 ⁵	Green	—	—	601967-1
24-20	0.2-0.6	.040-.062 1.02-1.57	201578-4	—	201578-1 ⁴	201580-1 ⁵	Yellow/Red	90249-2	90230-1 ⁷	91538-1 or 58541-1 [*]
			201330-6	201328-9	201330-1 ⁴	201328-1 ⁵	Yellow/Red			—
18 (Two)	0.9-0.9 (Two)	No. Ins. Support	—	—	202725-1 ⁴	202726-1 ⁴	Blue	—	90231-2 ⁷	91539-1 or 601967-1
18-16	0.8-1.4	.080-.105 2.03-2.67	—	—	202507-1 ⁴	202508-1 ⁵	—	—	—	90136-1 or 601967-1
			200336-6	200333-8	200336-1 ⁴	200333-1 ⁴	Blue/Blue	90250-1	90231-2 ⁷	91539-1 58541-1 [*] or 601967-1
14	2	No Ins. Support	212618-2 ³	201568-3	201570-1 ⁴	201568-1 ⁵	Violet/Blue	90250-1	90231-2 ⁷	91539-1 58541-1 [*] or 601967-1
			—	—	212618-1 ^{3,6,t}	—	—	—	—	—

¹Overall insulation crimp diameter, including crimp barrel, must not exceed .125 [3.18].

²For AMP-TAPETRONIC Machine Part Number 69875, order contacts by Tape Mounted Contact No., plus packaging code "IM REEL" (5000 parts per reel).

³Grounding pin is used to provide a make-first/break-last condition when mating and unmating connector halves.

⁴Use turret TH502 (1-601967-6) with hand tool 601967-1.

⁵Use turret TH501 (1-601967-5) with hand tool 601967-1.

⁶Pin length is .630±0.005 [16.002±.127] on these two pins.

⁷Die Set requires "C" Head Adapter Part Number 318161-1; Adapter Holder Part Number 356304-1 (with ratchet) or 189928-1 (without); and Power Unit Part Number 189721-2 (hand actuated) or 189722-2 (foot actuated).

^{*}Commercial PRO-CRIMPER II Hand Tool for field repair use only. Note: Die Set can be adapted for use with the 626 Pneumatic Tool System.

^tDoes not use Hand Tool 91539-1 or 601967-1.

[‡]Single contact, free-air test current is not to be construed as contact rating current.

Insertion Tool Part Number 200893-2 (for insulation diameters .070 [1.78] or less).

Extraction Tool Part Number 305183.

Signal Contacts (Continued)

Type III+ Precision Formed, Crimp

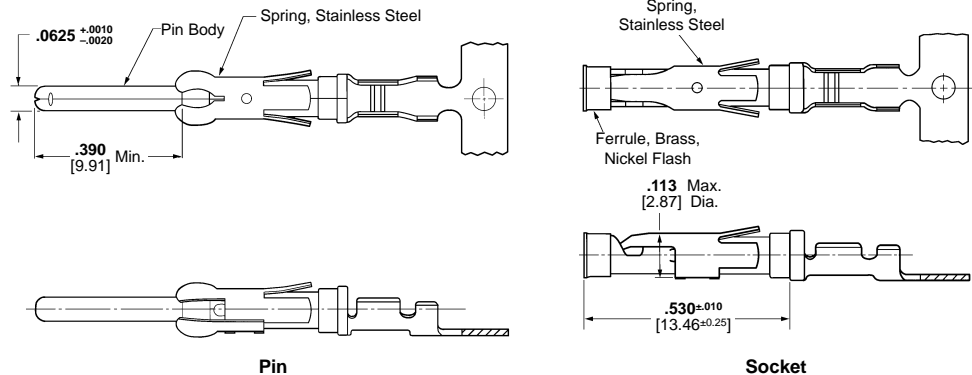
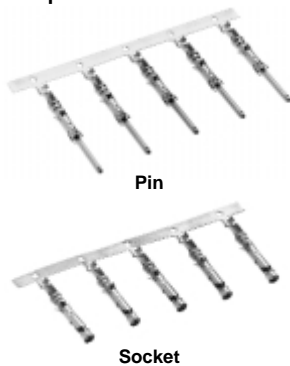

Material and Finish

Contact Body — Brass
Retention Spring — Stainless steel

Contact Size 16—Pin Diameter .062 [1.57] (Test Current, 13 Ampere)‡

Wire Size Range		Ins. Dia. Range	Contact Finish	Strip Form Contact No.		Loose Piece Contact No.		Tooling Part No.	
AWG	mm ²			Pin	Socket	Pin	Socket	Loose Piece Hand Tool	Strip Form Applicators
30-26	0.05-0.15	.040-.060 ¹ 1.02-1.52	Bright Tin-Lead	66425-6	66424-6	—	—	91515-1 ⁵	466598-□***
			Gold/Nickel ²	66425-7	66424-7	66429-3	66428-3		
			Sel. Gold/Nickel ³	66425-8	66424-8	66429-4	66428-4		
26-24	0.12-0.2	.035-.055 ¹ 0.89-1.40	Gold/Nickel ²	66393-7	66394-7	—	—	90225-2 ⁵	466585-3***
			Sel. Gold/Nickel ³	66393-8	66394-8	66406-4	66405-4		
			Bright Tin-Lead	66106-6	66108-6	66107-2	66109-2		
24-20	0.2-0.6	.040-.080 ¹ 1.02-2.03	Gold/Nickel ²	66106-7	66108-7	66107-3	66109-3	91515-1 ⁵ or 58495-1*	466321-□*** or 466908-2***
			Sel. Gold/Nickel ³	66106-8	66108-8	66107-4	66109-4		
			Bright Tin-Lead	66102-7	66104-7	66103-2	66105-2		
18-16	0.8-1.4	.080-.100 ¹ 2.03-2.54	Gold/Nickel ²	66102-8	66104-8	66103-3	66105-3	91515-1 ⁵ or 58495-1*	466323-□*** or 466907-2***
			Sel. Gold/Nickel ³	66102-9	66104-9	66103-4	66105-4		
			Bright Tin-Lead	66564-6	66563-6	66566-2	66565-2		
18-14	0.8-2.0	.080-.100 ¹ 2.03-2.54	Gold/Nickel ²	66564-8	66563-8	66566-4	66565-4	91542-1 ⁵	466383-4*** or 466979-1*** or 567363-□***
			Sel. Gold/Nickel ³	66332-5	66331-5	66400-1	66399-1		
			Bright Tin-Lead	66332-7	66331-7	66400-3	66399-3		
18-14	0.8-2.0	.110-.150 ⁴ 2.79-3.81	Gold/Nickel ²	66332-8	66331-8	66400-4	66399-4	91519-1 ⁵	466326-□*** or 466923-2***
			Sel. Gold/Nickel ³	66098-7	66100-7	66099-2	66101-2		
			Bright Tin-Lead	66098-8	66100-8	66099-3	66101-3		
18-14	0.8-2.0	.110-.150 ⁴ 2.79-3.81	Gold/Nickel ²	66098-9	66100-9	66099-4	66101-4	91505-1 ⁵ or 91523-1 ⁵ or 58495-1*	466325-□*** or 466906-1***
			Sel. Gold/Nickel ³	66359-6	66358-6	66361-2	66360-2		
			Bright Tin-Lead	66359-9	66358-9	66361-3	66360-3		
18-14	0.8-2.0	.110-.150 ⁴ 2.79-3.81	Gold/Nickel ²	1-66359-0	1-66358-0	66361-4	66360-4	91519-1 ⁵	466958-1*** or 567364-□***
			Sel. Gold/Nickel ³	66597-1	66598-1	66602-1	66601-1		
			Bright Tin-Lead	—	—	—	—		
18-14	0.8-2.0	.110-.150 ⁴ 2.79-3.81	Gold/Nickel ²	66597-2	66598-2	66602-2	66601-2	91521-1 ⁵	466958-1*** or 567364-□***
			Sel. Gold/Nickel ³	—	—	—	—		
			Bright Tin-Lead	—	—	—	—		

¹Overall insulation crimp diameter, including crimp barrel, must not exceed .125 [3.18].

².000015 [0.00038] gold in the mating area over .000030 [0.00076] min. nickel.

³.000030 [0.00076] gold in the mating area over .000030 [0.00076] min. nickel.

⁴Contacts can only be used in Metrimate, Series 1 (Arr. 23-24), Series 4 (Arr. 23-13M, 23-16M, 23-22M), and VDE connectors.

⁵To use with the 626 Pneumatic Tool System: remove the crimping head from the Straight Action Hand Tool (SAHT) Assembly, order SAHT Adapter (Contact Technical Support for Part Number), Adapter Holder Part Number 356304-1 (with ratchet) or 189928-1 (without), and Power Unit Part Number 189721-1 (hand actuated) or 189722-1 (foot actuated).

*Commercial PRO-CRIMPER II hand tool for field repair only. Note: Die Set can be adapted for use with the 626 Pneumatic Tool System.

‡Single contact, free-air test current is not to be construed as contact rating current. Use only for testing.

Insertion Tool Part Number 91002-1 (for insulation diameters .070 [1.78] or less), Number 200893-2 (for insulation diameters .090 [2.29] max.).

Extraction Tool Part Number 305183.

***Contact Technical Support for Automatic Machine Applicator Part Numbers.

Multimate Contacts

Type VI Contacts

Contact size — 16
 Pin diameter — .062 [1.57]
 Test current — 13 amperes*
 Material — Copper alloy

Contact Finish:

A — Tin
 B — Gold flash over .000050 [0.00127] nickel on entire contact with .000030 [0.00076] selective gold plating on contact area

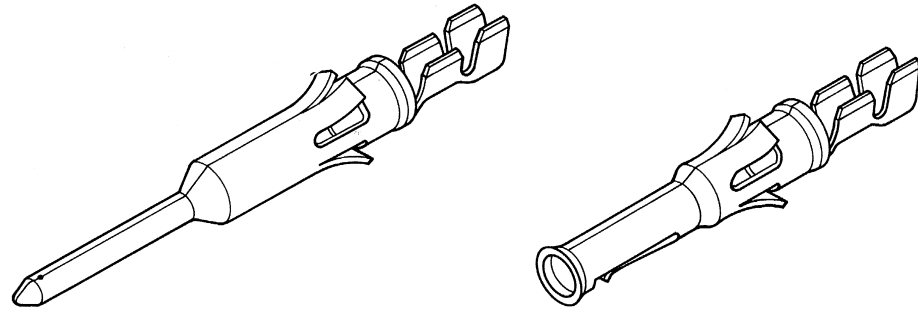

Pin

Socket

*Note: Current carrying capability depends on wire size, connector size and ambient temperature.

Wire Size Range ¹		Ins. Dia. Range	Contact Finish	Contact Part Number (reeled for AMP Standard Applicator)		Contact Part Numbers (reeled for AMP Quick-Change Applicator)		Loose Piece Contact Part No.		Tooling Part Numbers Hand Tool
AWG	[mm ²]			Pin	Socket	Pin	Socket	Pin	Socket	
28-26	0.08-0.15	.035-.055 0.89-1.4	A	66585-1	—	66585-2	—	—	—	91515-1 58495-1 ³
			B	—	—	66585-4	66586-4	66595-2	66596-2	—
24-20	0.2-0.6	.040-.080 1.02-2.03	A	66583-1	66584-1	66583-2	66584-2	66593-1	66594-1	91515-1 58495-1 ³
			B	—	—	66583-4	66584-4	66593-2	66594-2	—
22-18	0.3-0.9	.055-.110 1.40-2.79	A	66581-1	66582-1	66581-2	66582-2	66591-1	66592-1	90327-1
			B	—	—	66581-4	66582-4	66591-2	66592-2	—
18-16	0.8-1.4	.080-.100 2.03-2.54	A	66579-1	66580-1	66579-2	66580-2	66589-1	66590-1	91515-1 58495-1 ³
			B	—	—	66579-4	66580-4	66589-2	66590-2	—
14	2	.080-.135 ² 2.03-3.43	A	66577-1	66578-1	66577-2	66578-2	66587-1	—	91550-1
			B	—	—	66577-4	66578-4	66587-2	66588-2	—

¹Wire strip length—.156 [.396] (all wire sizes).

²Maximum insulation diameter recommended for "G" Series connectors with Multimate contact cavities is .110 [2.79].

³Economy Hand Tool for field repair only.

Insertion Tool Part Number 91002-1 for insulation diameters .070 [1.78] or less.

Extraction Tool Part Number 305183.

Applicator Nos. for Terminating Machines

Wire Size Range		Model K	Model T	Model G	Model Stripper/Crimper
AWG	mm ²				
28-26	0.08-0.15	466321-4	466321-3	466321-6	466908-2
24-20	0.2-0.6	466323-4	466323-3	—	466907-2
22-18	0.3-0.9	466384-4	466384-3	—	466914-1
18-16	0.8-1.4	466325-2	466325-1	466325-5	—
14	2	687997-2 ⁴ 687997-4 ⁴	—	—	—

⁴Insulation Dia. Range—Part Number 687997-2, .080-.105 [2.03-2.67]; Part Number 687997-4, .105-.135 [2.67-3.43].

Multimate Contacts (Continued)

Type XII Power Contacts

Continuous Operating Current

Silver or gold — 25 amperes max.

Tin-lead — 15 amperes max.

Material — Copper

Contact Finish

A — Tin-Lead

B — .000030 [0.00076] selective gold over .000030 [0.00076] nickel

C — .000100 [0.00254] silver plated contacts with lubricant added

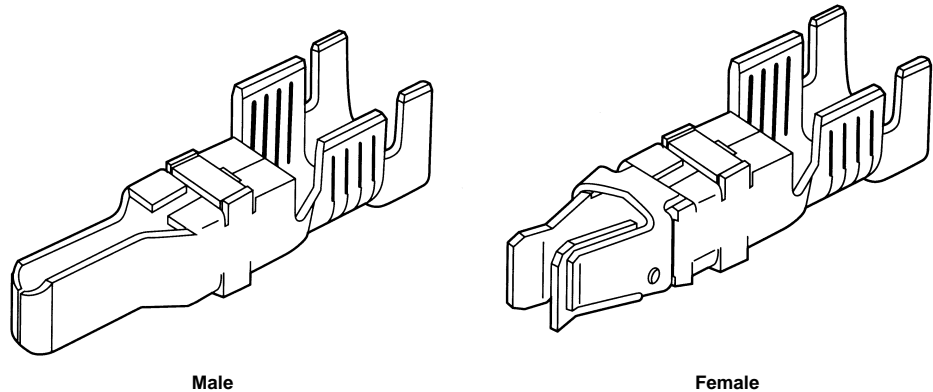

Wire Size Range ¹		Ins. Dia. Range	Contact Finish	Strip Form Contact Part Number				Loose Piece Contact Part No.		Die Insert Number for Hand Tool 69710-1, or 626 Pneumatic Tool System**
AWG	[mm ²]			for Standard Applicator		for Quick-Change Applicator*		Male	Female	
16 and 14-12	1.25-1.4 and 2-3	.135-.160 3.43-4.06	A	66255-1	66740-7	66255-5	1-66740-2	66261-1	66740-8	90145-2 ³ and 90145-1 ⁴
				66256-1 ²	—	66256-5 ²	—	66262-1 ²	—	
			B	66255-2	66740-5	66255-6	1-66740-1	66261-2	66740-6	
				66256-2 ²	—	66256-4 ²	—	66262-2 ²	—	
			C5	66255-7	66740-1	66255-8	66740-9	66261-4	66740-2	
				66256-6 ²	—	66256-7 ²	—	66262-4 ²	—	
10	5-6	.190-.220 4.83-5.59	A	66253-1	66741-7	66253-5	1-66741-2	66259-1	66741-8	90140-1
				66254-1 ²	—	—	—	66260-1 ²	—	
			B	66253-2	66741-5	66253-6	1-66741-1	66259-2	66741-6	
				66254-2 ²	—	—	—	66260-2 ²	—	
			C5	66253-4	66741-1	66253-8	66741-9	66259-4	66741-2	
				66254-4 ²	—	—	—	66260-4 ²	—	

¹Wire strip length—.281 [7.14]

²Grounding Contact

³Die Insert Part Number 90145-2 is for crimping 16 AWG [1.25-1.4 mm²] wire

⁴Die Insert Part Number 90145-1 is for crimping 14-12 AWG [2-3 mm²] wire

⁵Recommended for high current/vibration applications where fretting corrosion is a problem.

Extraction Tool Part Number 91019-3

*Quick-Change Applicators for—16-14-12 AWG: Model K—Part Number 567455-2, Model T—Part Number 567455-1, Model G—Part Number 567455-3
10 AWG: Model K—Part Number 567021-2, Model T—Part Number 567021-1, Model G—Part Number 567021-4

** Use 626 adapter 318161-1

Multimate Contacts (Continued)

Miniature COAXICON Contacts

Material

Outer Shell — Brass per MIL-C-50

Center Conductor — Beryllium copper

Inner Dielectric — Polypropylene

Retention Spring — Passivated stainless steel

Ferrule — Copper

Finish

Outer Shell, Center Conductor — .000030 [0.00076] gold over .000030 [0.00076] nickel

Retention Spring — Nickel per QQ-N-290

Ferrule — Bright tin-lead per MIL-T-10727

Contacts

A — .000030 [0.00076] gold

B — .000100 [0.00254] gold

Test Method for Electronic and Electrical Component Parts: MIL-STD-202

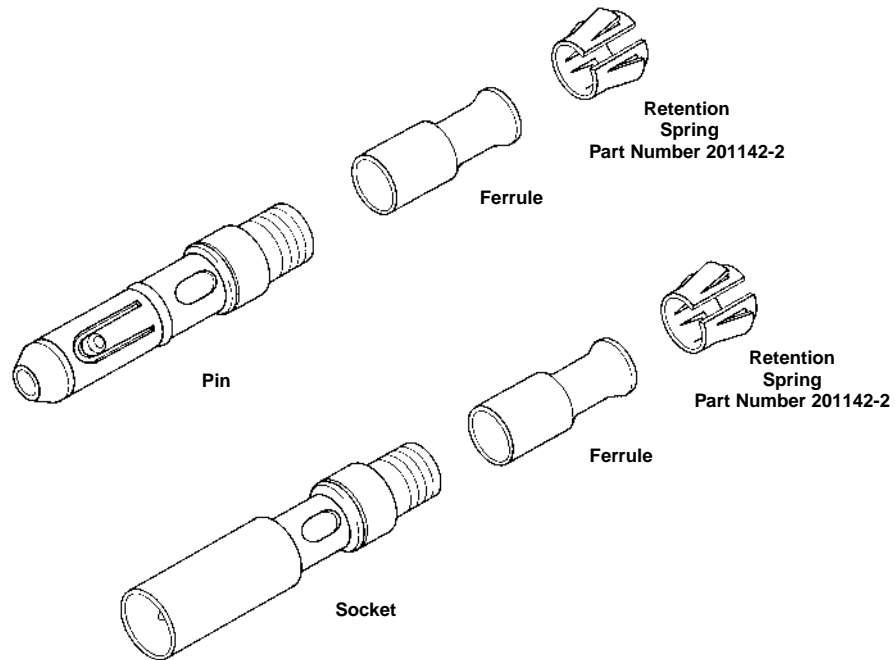

Selection Chart for Coaxial Cable

Cable Size (RG/U)	Contact Finish	Loose Piece Contact Part Number		Ferrule Part Number	Tooling Part Number		Tool Handle, Die Insert and Plastic Collar Color Code**
		Pin	Socket		Die Insert for Hand Tool 69710 or 626 Pneumatic Tool System ²	Hand Tool Number	
55, 55A, 55B, 141, 142, 223	A	201145-4	201146-4	330478	69315-4	69248-4	Blue & Orange
	B	—	201146-9				
58, 58A, 58B, 58C	A	201145-4	201146-4	—	69220-2	—	Blue
	B	—	201146-9				
59, 59A, 59B, 62, 62A, 62B 124, 140, 210 (4-Position Only)	A	201097-1	201098-1	329006	69675-1	91912-4 ¹	Yellow
	A	201143-1	201144-1				
179, 179A, 187, 21-598	B	—	201144-6	328666	69227-2	91912-3 ¹	White
	A	201145-2	201146-2				
180, 180A, 195, 21-597	B	1-201145-0	1-201146-0	328664	69222-2	—	Red
	A	201511-1	—				
178, 178A, 196	A	201143-5	201144-5	328667	69373	69186-2	Brown
	B	201143-7	201144-7				
174, 188, 316	A	201143-5	201144-5	328666	69227-2	91912-3 ¹	White
	B	201143-7	201144-7				
122	A	201145-1	201146-4	328664	69222-2	45639-2	Red

*Includes bench mount and foot control.

**Match Plastic Collar and Tool colors for application to cable, Inner Insulator color identifies Wire Barrel of Center Contact

Note: A ferrule and retention spring (Part Number 201142-2) are required for each pin and socket.

Extraction Tool Part Number 305183-8

¹ SDE die used with tool frame 354940-1

² Use 626 adapter 318161-1

Selection Chart for Twisted Pair Leads

Wire Size Range		Max. Ins. Dia. (Two Wires Combined)	Contact Finish	Loose Piece Contact Part Number		Ferrule Part Number	Tooling Part Number		Tool Handle, Die Insert and Plastic Collar Color Code **
AWG	[mm ²]			Pin	Socket		Die Inserts for Hand Tool 69710-1 or 626 Pneumatic Tool System ¹	Hand Tool	
28-26 (Solid)	0.08-0.15	.080 2.03	A	201511-1	—	328667	69373	69186-2	Brown
24-22 (Stranded)	0.2-0.4	.115 2.92	A	201143-5	201144-5	328666	69672	91912-4 ²	Gray and White
			B	201143-7	201144-7				
24-22 (Solid or Stranded)	0.2-0.4	.160 .406	A	50079-1	50080-1	329029	69222-2	45639-2	Red

Selection Chart for Shielded Wire

Cable Size (RG/U)	Contact Finish	Loose Piece Contact Part Number		Ferrule Part Number	Tooling Part Number		Tool Handle, Die Insert and Plastic Collar Color Code **
		Pin	Socket		Die Inserts for Hand Tool 69710 or 626 Pneumatic Tool System ¹	Hand Tool	
No. 26, NAS-702, Class A & C No. 26, MIL-W-16878, Types E & EE No. 24, NAS-702, Class A & C No. 24, MIL-W-16878, Types E & EE No. 22, NAS 702, Class C No. 22, MIL-W-16878, Type E No. 22, MIL-C-7078 A, Type I No. 1 Dielectric, .068 [1.73] O.D.	A	201143-2	201144-2	328666	—	69147-2	Gray
No. 22, NAS-702, Class A No. 22, MIL-C-7078 A, Type II	A	201143-3	201144-3	328666	69227-2	91912-3 ²	White
No. 22, MIL-C-7078 A, Types I & II No. 2 Dielectric, .075 [1.91] O.D. No. 3 Dielectric, .085 [2.16] O.D.	A	201145-1	201146-4	—	69222-2	45639-2	Red
No. 22, NAS-702, Class B	A	201145-4	201146-4	328663	69220-2	45740-2	Blue
	B	—	201146-9				

Selection Chart for Various Manufacturers' Cables

Center Conductor Wire		Dielectric O.D. (Max.)	Cable O.D. Range	Braid	Loose Piece Contact Part No.		Ferrule Part Number	Tooling Part Number		Tool Handle, Die Insert and Plastic Collar Color Code**
AWG/Type	[mm ²]				Pin	Socket		Die Inserts for Hand Tool 69710-1 or 626 Pneumatic Tool System ¹	Hand Tool	
Brand Rex T209A 29 AWG	0.7-0.08	.076 1.93	.112-.122 2.84-3.1	Single	—	201146-2	330587	69440	—	Orange
Brand Rex T5788A 26 AWG	0.12-0.15	.106 2.69	.160 4.06	Single	201145-2	201146-2	328664	69222-2	45639-2	Red
32-26	0.03-0.15	.129 3.28	.122-.137 3.1-3.48	Single	—	201146-2	330587	69440	—	Orange
Raychem 0030D1314 Army Ordnance 11207177										

*Includes bench mount and foot control; requires Manual Take-Up Attachment Part Number 69689
 **Match Plastic Collar and Tool colors for application to cable. Inner Insulator color identifies Wire Barrel of Center Contact.
 Note: A ferrule and retention spring (Part Number 201142-2) are required for each pin and socket.
 Extraction Tool Part Number 305183-8
¹ Use 626 adapter 318161-1
² SDE die used with tool frame 354940-1

Coaxial Contacts

Subminiature Coax, Size 16
Precision Formed, Crimp



Pin



Socket

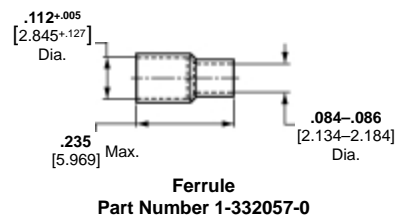
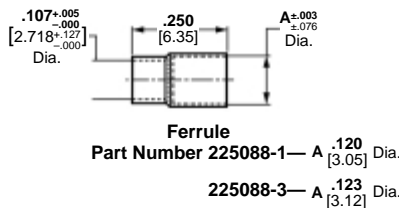
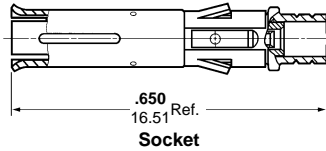
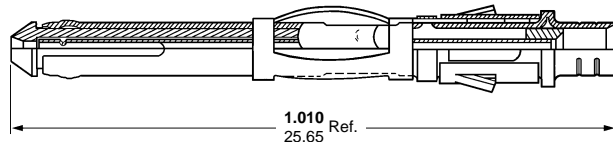

Material

Outer Shell — Brass per MIL-C-50

Center Conductor — Beryllium copper per QQ-C-533 (Pin); Brass per QQ-B-626 (Socket)

Inner Dielectric — Polypropylene

Retention Spring — Stainless steel per QQ-S-766

Ferrule — Copper per QQ-C-576

Finish

Outer Shell, Center Conductor — See charts

Ferrule† — Bright tin-lead per MIL-T-10727

Selection Chart for Coaxial Cable

Cable Size (RG/U)	Contact Finish	Loose Piece Contact No.		Ferrule Part No.	Tooling Part No.	
		Pin	Socket		Die Sets for Hand Tool 69710-1 or 626 Pneumatic Tool System	Hand Tool
178, 196	Gold/Nickel Gold/Copper ¹	226537-2	51565-2	1-332057-0†	69690-2 ³	69656-2
	Gold/Nickel Gold/Copper ²	—	51565-5			
196 (Double Braid)	Gold/Nickel Gold/Copper ¹	226537-2	51565-2	225088-1†	—	69656-9
	Gold/Nickel Gold/Copper ²	—	51565-5			
174, 188, 316	Gold/Nickel Gold/Copper ¹	226537-1	51565-1	1-332056-0	69690 ³	91911-3*
	Gold/Nickel Gold/Copper ²	226537-4	51565-4			
174 (Double Braid)	Gold/Nickel Gold/Copper ¹	226537-1	51565-1	225088-3	—	69656-7
	Gold/Nickel Gold/Copper ²	226537-4	51565-4			
179, 187	Gold/Nickel Gold/Copper ¹	226537-1	51565-1	1-332056-0	69690-1 ³	91911-4*
	Gold/Nickel Gold/Copper ²	226537-4	51565-4			
187 (Double Braid)	Gold/Nickel Gold/Copper ¹	226537-1	51565-1	225088-1†	—	69656-8
	Gold/Nickel Gold/Copper ²	226537-4	51565-4			
161	Gold/Nickel Gold/Copper ¹	226537-1	51565-1	1-332056-0	—	—
	Gold/Nickel Gold/Copper ²	226537-4	51565-4			

¹.000030 [0.00076] gold over .000050 [0.00127] nickel—outer shell and socket center conductor; .000030 [0.00076] gold over .000100 [0.00254] copper—pin center conductor.

².000050 [0.00127] gold over .000050 [0.00127] nickel—outer shell and socket center conductor; .000050 [0.00127] gold over .000100 [0.00254] copper—pin center conductor.

³Die Set requires "C" Head Adapter Part Number 318161-1; Adapter Holder Part Number 356304-1 (with ratchet) or 189928-1 (without); and Power Unit Part Number 189721-2 (hand actuated) or 189722-2 (foot actuated).

†Does not use Hand Tool 45098 or 601967-1.

Extraction Tool Part Number 305183

* SDE die used with tool frame 354940-1

**Subminiature Coax, Size 16
Precision Formed, Crimp**

(Continued)

Finish

Ferrule¹ — Bright tin-lead per MIL-T-10727

Coaxial Contacts (Continued)

Selection Chart for Twisted Pair and Shielded Wire

Wire Size		Contact Finish	Loose Piece Contact No.		Ferrule Part No.	Tooling Part No.	
AWG	mm ²		Pin	Socket		Die Sets for Hand Tool 69710-1 or 626 Pneumatic Tool System	Hand Tool
30 (Twisted Pair, Solid)	0.05	Gold/Nickel Gold/Copper ¹	226537-3	51565-3	1-332057-0†	69690-2 ³	69656-2
		Gold/Nickel Gold/Copper ²	226537-6	51565-6			
28 (Twisted Pair, Solid)	0.08-0.09	Gold/Nickel Gold/Copper ¹	226537-3	51565-3	1-332057-0†	69690 ³	91911-3*
		Gold/Nickel Gold/Copper ²	226537-6	51565-6			
28 (Twisted Pair, Stranded 7 Str., .0050 [0.13] Dia.)	0.08-0.09	Gold/Nickel Gold/Copper ¹	226537-3	51565-3	1-332057-0†	69690-1 ³ or 69690-2 ³	91911-4* or 69656-2
		Gold/Nickel Gold/Copper ²	226537-6	51565-6			
26 (Twisted Pair, Solid or Stranded 7 Str., .0063 [0.16] Dia.)	0.12-0.15	Gold/Nickel Gold/Copper ¹	226537-3	51565-3	1-332057-0†	69690 ³	91911-3*
		Gold/Nickel Gold/Copper ²	226537-6	51565-6			
26 (Shielded, .075 [1.91] Max. O.D.)	0.12-0.15	Gold/Nickel Gold/Copper ¹	226537-1	51565-1	1-332057-0†	69690-3 ³	69656-3
		Gold/Nickel Gold/Copper ²	226537-4	51565-4			

¹.000030 [0.00076] gold over .000050 [0.00127] nickel—outer shell and socket center conductor; .000030 [0.00076] gold over .000100 [0.00254] copper—pin center conductor.

².000050 [0.00127] gold over .000050 [0.00127] nickel—outer shell and socket center conductor; .000050 [0.00127] gold over .000100 [0.00254] copper—pin center conductor.

³Die Set requires "C" Head Adapter Part Number 318161-1; Adapter Holder Part Number 356304-1 (with ratchet) or 189928-1 (without); and Power Unit Part Number 189721-2 (hand actuated) or 189722-2 (foot actuated).

Note: A ferrule is required for each pin and socket. Extraction Tool Part Number 305183.

* SDE die used with tool frame 354940-1

One-Module Shell

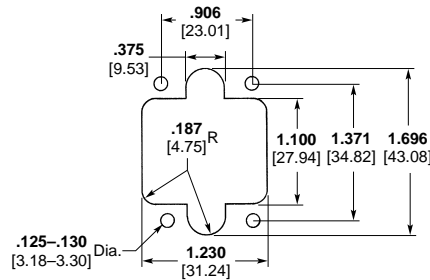
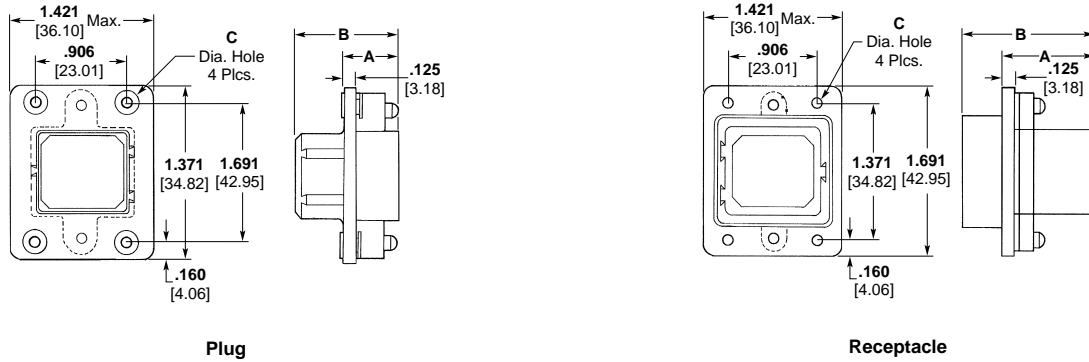

Recommended Panel Cutout

Shell Type	For Pin Module				For Socket Module			
	Dimensions			Shell Part No.	Dimensions			Shell Part No.
	A	B	C		A	B	C	
Receptacle	1.001 25.43	1.509 38.33	.120 3.05	202279-3	.595 15.11	1.103 28.02	.120 3.05	202279-4
Plug (with Floating Bushings)	.886 22.5	1.416 35.97	.118 3.00	202275-4	.480 12.19	1.010 25.65	.118 3.00	202275-3
Plug (without Floating Bushings)	.886 22.5	1.416 35.97	.125 3.18	202786-2	.480 12.19	1.010 25.65	.125 3.18	202786-1

- Notes:**
1. Plugs for pin modules mate with receptacles for socket modules, and plug for socket modules mate with receptacles for pin modules.
 2. Completely assembled connectors are available upon request. Consult Tyco Electronics for part nos. of specific arrangements desired.
 3. Pin and socket modules for these shells are presented on page 5160.
 4. For cable clamps and latching hardware, see pages 5172 and 5173.

Two-Module Shell

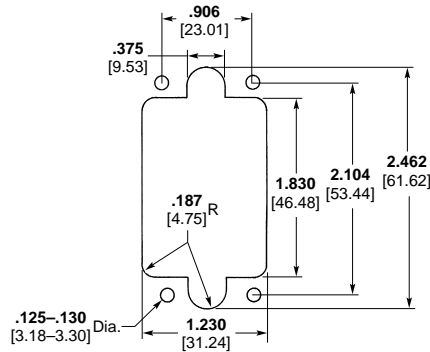
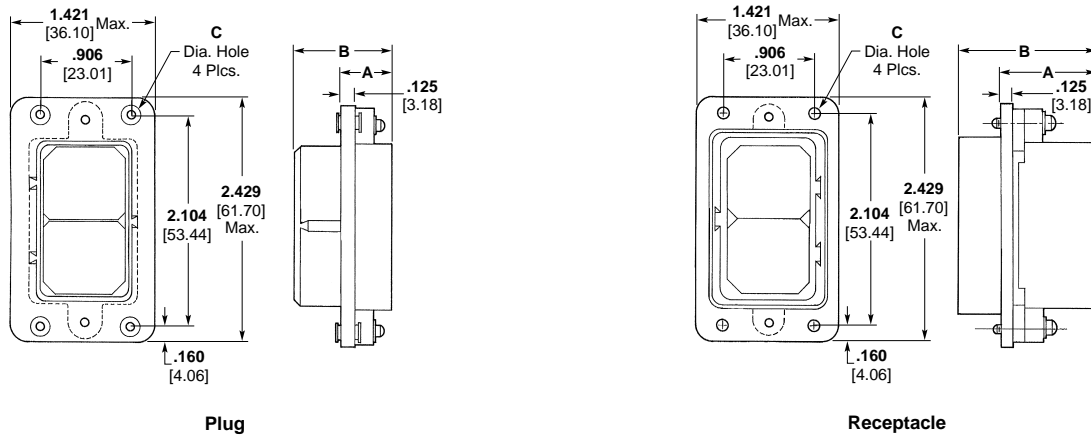

Recommended Panel Cutout

Shell Type	For Pin Module				For Socket Module			
	Dimensions			Shell Part No.	Dimensions			Shell Part No.
	A	B	C		A	B	C	
Receptacle	1.001 25.43	1.509 38.33	.120 3.05	202681-2	.595 15.11	1.103 28.02	.120 3.05	202681-3
Plug (with Floating Bushings)	.886 22.5	1.416 35.97	.118 3.00	202680-3	.480 12.19	1.010 25.65	.118 3.00	202680-2
Plug (without Floating Bushings)	.886 22.5	1.416 35.97	.125 3.18	202789-2	.480 12.19	1.010 25.65	.125 3.18	202789-1

- Notes:**
1. Plugs for pin modules mate with receptacles for socket modules, and plug for socket modules mate with receptacles for pin modules.
 2. Completely assembled connectors are available upon request. Consult Tyco Electronics for part nos. of specific arrangements desired.
 3. Pin and socket modules for these shells are presented on page 5160.
 4. For cable clamps and latching hardware, see pages 5172 and 5173.

Three-Module Shell

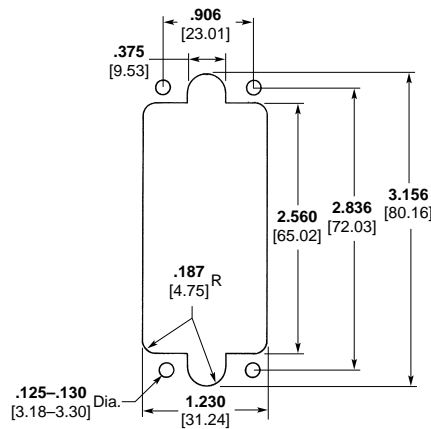
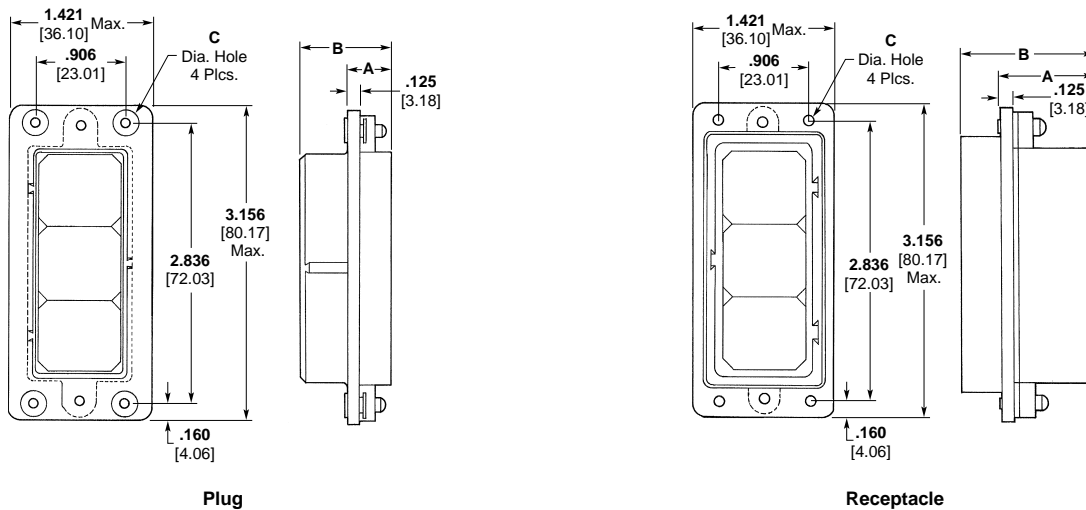

Recommended Panel Cutout

Shell Type	For Pin Module				For Socket Module			
	Dimensions			Shell Part No.	Dimensions			Shell Part No.
	A	B	C		A	B	C	
Receptacle	1.001 25.43	1.509 38.33	.120 3.05	202287-3	.595 15.11	1.103 28.02	.120 3.05	202287-4
Plug (with Floating Bushings)	.886 22.5	1.416 35.97	.118 3.00	202283-4	.480 12.19	1.010 25.65	.118 3.00	202283-3
Plug (without Floating Bushings)	.886 22.5	1.416 35.97	.125 3.18	202795-2	.480 12.19	1.010 25.65	.125 3.18	202795-1

Accessories

Cable Clamps, Straight Cable Exit

Material and Finish

Clamp and Shell — Die cast aluminum, zinc plated

Fillister Head Screws — Cold rolled steel, zinc plated

Cable Bushings — Rubber, black

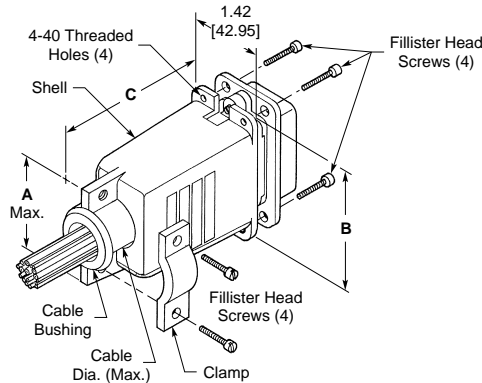

Shell Size (No. of Modules)	Dimensions			Cable Dia. (Max.)	Cable Bushings	Cable Part No.
	A	B	C			
1	1.315	1.416	2.625	.750	With	202764-1*
	33.4	35.96	66.68	19.05	Without	202764-2
2	1.100	1.691	2.625	.563	Without	202305-3
	27.94	42.95	66.68	14.3		
3	1.820	2.424	3.140	.875	With	202617-1*
	46.23	61.57	69.76	22.23	Without	202617-2
3	2.135	3.156	3.140	1.156	With	1-202301-1**
	54.23	80.16	79.76	29.37	Without	1-202301-0

*Two Cable Bushings are included to provide .625 [15.88] and .250 [6.35] diameter cable outlets.

**Four Cable Bushings are included to provide .938 [23.83], .750 [19.05], .625 [15.88] and .250 [6.35] diameter cable outlets.

Note: These cable clamps can be used on either a plug or receptacle shell of the appropriate size; refer to pages 5169-5171.

Cable Clamps, 90° Cable Exit (For One-Module Shell)

Part Number 206132-1

Material and Finish

Clamp — Steel, cadmium plated

Shell — Thermoplastic, gray

Fillister Head Screws — Cold rolled steel, zinc plated

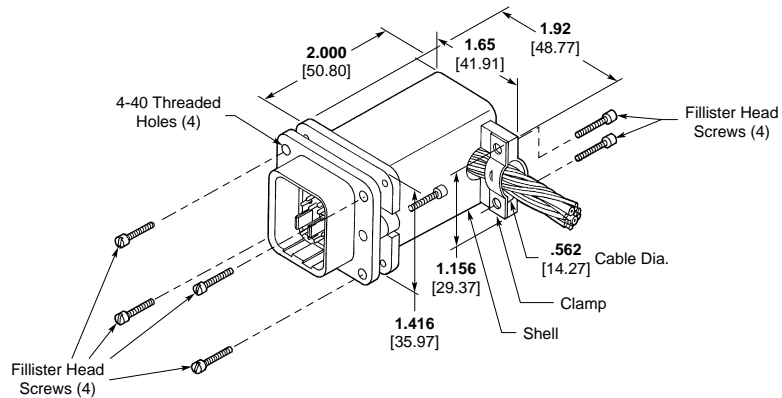

Note: This cable clamp can be used on either a plug or receptacle shell, one-module size only, refer to page 5169.

**Strain Relief
(for Three-Module Shell)**

Part Number 202567-1

Note: This strain relief can be used on either a plug or receptacle shell, three-module size only, refer to page 5171.

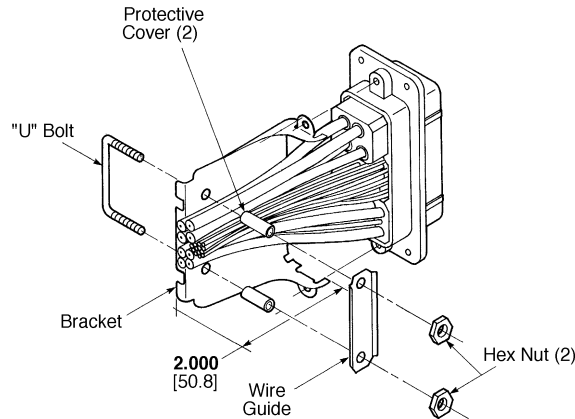

Locking Latch Assembly

Part Number 202832-1
(without mounting hardware)

Part Number 202832-2
(with mounting hardware*)

*Mounting hardware includes four lock washers, 4-40 hex nuts and fillister head screws.

Notes:

1. Locking Latch Assemblies are packaged two per unit.
2. Locking Latch Assemblies can be used on either a plug or receptacle shell. They cannot be used with shells having floating bushings.
3. Locking Latch Assemblies must

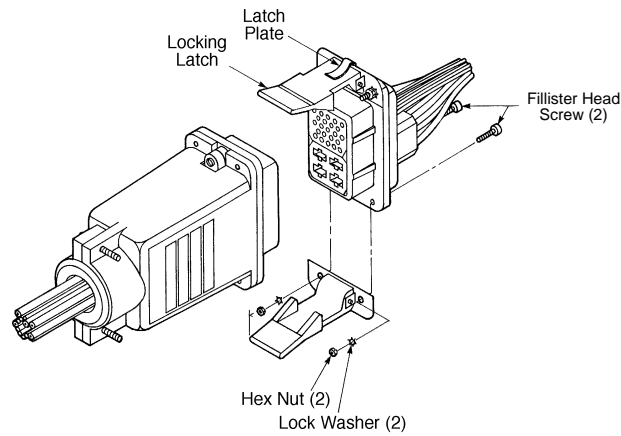

Locking Spring

Part Number 202577-1
(without mounting hardware)

Part Number 202577-2
(with mounting hardware*)

Spring Catch

Part Number 202576-1
(without mounting hardware)

Part Number 202576-2
(with mounting hardware*)

*Mounting hardware includes two lock washers, 4-40 hex nuts and screws.

Notes:

1. Locking springs and spring catches are packaged two per kit.
2. Locking springs and spring catches can be used on either a plug or receptacle shell. They cannot be used with shells having floating bushings.

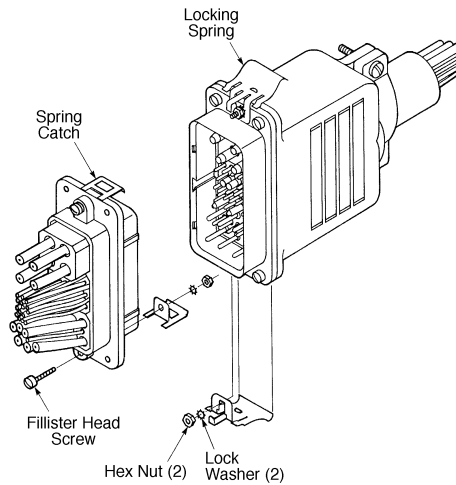

CERTI-CRIMP and CERTI-CRIMP II Hand Tools

These tools are ideal for small production, prototype and experimental applications. They are used for terminating pin and socket contacts to wire and feature the CERTI-CRIMP ratchet device to form accurate crimps each time.



Hand Tool Part Number 69710



CERTI-CRIMP II
Straight Action Hand Tool



SDE die in
PRO-CRIMPER frame. Go to
www.tooling.tycoelectronics.com
for additional tooling options
for SDE dies.

"G" Series Modular Connectors

Application Tooling

626 Pneumatic Tool System

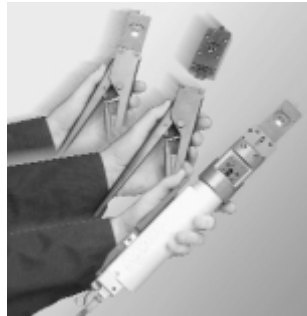

Lightweight, air-operated modular tooling system. Accepts a wide variety of interchangeable heads for crimping various types of contacts, terminals and splices onto wires ranging 6-26 AWG [13-0.12 mm²], plus coaxial and fiber optic cable. Available with either hand- or foot-actuation switch. Optional ratchet control available to provide complete crimp cycle.

Specifications

Outside Diameter — 1.83 [46.5]
Length — 11.6-12.9 [295-327]
Grip Span — 2.19 [55.6] over button/handle
Weight — 2.3-3.3 lb [1.0-1.5 kg]
Air — 90-100 psi [6.21-6.89 bar], 11.14 in³ [0.00018 m³]
Cycle Time — 0.7-0.8 sec (16-14 AWG [1.3-2 mm²] PIDG Terminals)
For more information, request Catalog 124208.

AMP-O-LECTRIC Model "K" Terminating Machine, 1-471273-3



Semiautomatic bench machine for use with standard-style applicators. It is an electrically-powered, clutched, flywheel-energy-style machine, equipped with a mechanical strip feed mechanism. Products commonly applied with this machine include AMP splices, AMPLIVAR splices, and FASTON flag receptacles.

Specifications

Width — 21 [533]
Depth — 20 [508]
Height — 24 [610] without reel
Weight — 230 lb [104 kg]
Electrical — 120 VAC, 60 Hz, 6 A
Air — 90-110 psi [6.21-7.59 bar], 6 scfm [0.00282 m³/s] when required with air-feed applicators
Wire Range — 26-10 AWG [0.12-6 mm²] solid or stranded, depending on product applied
For more information, contact Tyco Electronics.

AMP-O-LECTRIC Model "G" Terminating Machines, 354500-1, -9, -11



Semiautomatic bench machines for crimping reeled terminals and contacts, featuring a quiet and reliable direct motor drive, microprocessor controls for ease of setup and operation, and guarding and lighting designed for operator convenience. All models are equipped with either manual or automatic precision adjustment of crimp height. Machine-mounted sensors are available for crimp quality monitoring using conventional miniature-style applicators.

Specifications

Width — 18.7-25.3 [475-643] depending on applicator type
Depth — 21.5-28.1 [546-713] depending on applicator type
Height — 20 [508]
Weight — 240 lb [110 kg]
Electrical — 120 or 220 VAC, 50 or 60 Hz; 310 VA
Air — 90-110 psi [6.21-7.59 bar], 6 scfm [0.00282 m³/s] when required with air-feed applicators
Wire Range — 26-10 AWG [0.12-6 mm²] solid or stranded, depending on product applied
For more information, request Catalog 65828.

Application Tooling (Continued)

Entry Level Terminator (ELT), 1338600-1, -2, -3, -4, -5, -6

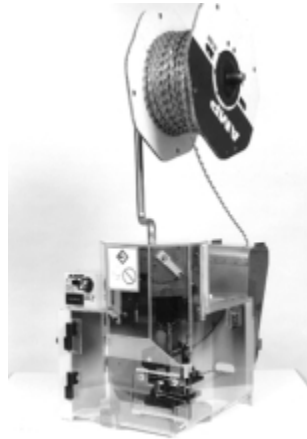

Semiautomatic Bench Terminator for side- and end-feed reeled terminals and contacts. The ELT uses a DC motor with gear box drive. The result is a small-footprint design that is fast and quiet. Cycle time is less than 0.400 seconds with an operation sound level of 76dBA. With a crimp force capacity of 3,000 pounds, the ELT is available for all but the highest crimp force applications. A wide range of optional equipment is also available to meet your specific application requirements.

Specifications

Width — 16.8 [427]
Depth — 20.6 [523]
Height — 20 [510] without reel support
Weight — approx. 150 lb [68 kg]
Electrical — 100-240 VAC, 50/60 Hz, 6A (Note: Avg <1 A at 120 VAC when used as a bench-top unit at 2,000 cycles per hour operating rate)
Air — 90-100 psi [6.21-6.90 bar], 6 scfm [0.00282 m³/s] when required for use with air-feed applicators (Note: Optional Air Feed Valve Assembly Required)
Wire Range — Up to 14 AWG [2.5 mm²]
 For more information, request catalog 1308382.

AMP-O-MATIC Stripper-Crimper Machines, 1320895-1, -2



Semiautomatic bench crimping machines that also strip the wire, and are therefore used for terminating jacketed cable. Feature manual precision adjustment of crimp height, keyed strip blades for faster, more accurate setups, and an efficient scrap removal system. All adjustments can be made from the front of the machines without special tools. Available with crimp quality monitoring.

Specifications

Width — 14 [355]
Depth — 18 [457]
Height — 33 [838] without reel
Weight — 150 lb [68 kg]
Electrical — 120 VAC, 50 or 60 Hz, 5 A
Air — 80-100 psi [5.52-6.90 bar], 3.5 scfm [0.00165 m³/s]
Wire Range — 32-14 AWG [0.03-2 mm²]
 For more information, request Catalog 65004.

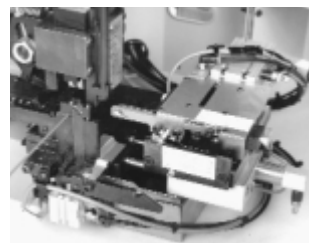

The combination of the Stripping Module with the Entry Level Terminator (ELT) or the AMP-O-LECTRIC Model G Terminator provides an economical and proficient method of stripping wire and crimping terminals on the same machine. Wires are stripped moments before crimping, meaning there is virtually no chance of damaging wire conductors during handling or storage. Once the wire is fed into the start sensor the Stripping Module does the rest, improving placement accuracy.

Specifications

Wire Range Base Module — 0.03 mm² - 2.0 mm² (32-14 AWG) (30-32 AWG may require special kit.)
Max. Insulation — .200 [5.08]
Cable Breakout — > 1.100 [29.00]
Strip Length — .100 - .400 [2.50 - 10.16]
Noise — Less than 82 dBA (Typical at operator position with standard mechanical feed applicator)
Weight — 4.53 Kilograms (10 lb)
Height — 5.000 [127.00]
Electrical — 100-240 VAC, 50/60 Hz, single phase current, obtains power from the terminator
Air — 620-760 kPa (90-100 psi), 2.83 liters/sec (6 scfm)
Wire Sensor — Gold plated contacts with laser etched target
 For more information, request Catalog 1309085.

Application Tooling (Continued)

AMPOMATOR CLS IV+ Lead-Making Machines, 356500-1, -2



Fully-automatic machines that measure, cut, strip and terminate single leads. Microprocessor-controlled, and programmed and operated using an easy-to-follow, menu-driven touch-screen. Features include direct-drive terminating units with precision crimp height adjustment, fully programmable setups, wire runout and splice detection, and motorized pre-feed with wire straightener. Crimp quality monitoring is also available.

Specifications

Width — 159 [4 040]
Depth — 68 [1 730]
Height — 86 [2 185] with 24 [610] dia. reel
Weight — 2 000 lb [907 kg]
Electrical — 220 VAC, 50 or 60 Hz, single phase, 25 A, with neutral and ground
Air — 90 psi [6.21 bar], 15 scfm [0.0071 m³/s] sustained
Wire Range — 26-10 AWG [0.12-6 mm²] stranded, 26-16 AWG [0.12-1.4 mm²] solid
Lead Lengths — 3-90 [76.2-2 285], 90-1 000 [2 285-25 400] with long lead conveyors
 For more information, request Catalog 124324.

Gamma 333 PC Lead-Making Machine, Three Stations, 1-528324-1

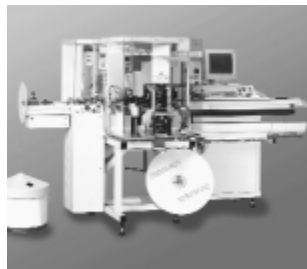

With its capacity to accommodate an additional processing station on side 1, the Gamma 333 PC can perform a number of new processes. It can produce two-ended crimp leads, process double crimp connections with three different terminals or apply seals on one end of the wire. Tinning and ink jet marking are two further options. Process monitoring is integrated into the system, for accurate trimming and stripping of the wires.

Specifications

Length — 125 [3137]
Width — 54.2 [1377]
Height — 70.5 [1790]
Length Range — 2.36 in-32.8 ft [60-10,000] (optional 30mm)
Cross-Section Range — AWG 26-AWG 10 [0.125mm²-5mm²]
Noise Level — <76dB (without crimping modules)
Electrical — 3x208 - 480V, 50-60Hz; 6kVA
Compressed Air — 5-6 bar
Air Consumption — 6.5m³/h
Weight — 1850 lbs [840 kg] with two crimping modules
 For more information, request Catalog 1307901.

Crimp Quality Monitor (CQM), 1320420-1, -2



This unique system provides 100% on-the-fly crimp inspection. It measures the crimp height of each termination, and evaluates the quality of each crimp. If a crimp is questionable, the monitor alerts the operator with both visual and audible alarms. It also provides ports for printing and networking. When used with AMP-O-LECTRIC Model "G" Termination Machines, the monitor is mounted to the

machine. When used with AMPOMATOR CLS IV Lead-Making Machines, it is integrated into the machine's operating system.

Specifications

Width — 8.8 [220]
Depth — 8.1 [205]
Height — 4.6 [115]
Weight — 5 lb [2.3 kg]
Electrical — 100-240 VAC, 50/60 Hz, 3.2 A
 For more information, request Catalog 82275.

Introduction

Product Facts

- Plug and receptacle connectors are molded plastic blocks categorized by the number of contact positions and type of material
- The pin body is fabricated from brass and conforms to MIL-C-50 or ASTM-B-36. The plating is gold per MIL-G-45204 over nickel per QQ-N-290. The retention spring sleeve is fabricated from stainless steel and conforms to QQ-S-766
- The socket body is made of brass per MIL-C-50 or ASTM-B-36. Plating is gold per MIL-G-45204 over nickel per QQ-N-290. The stainless steel retention spring sleeve conforms to QQ-S-766
- Shields and cable clamps are molded polysulfone components conforming to MIL-P-46120
- Brass keying pins and sockets conform to QQ-B-626 or ASTM-B-16, with zinc plating per QQ-Z-325 or stainless steel per QQ-S-763
- Locking rings, washers, bushings, retaining rings, nuts and screws are stainless steel conforming to QQ-S-763 or QQ-S-766
- Recognized under the Component Program of Underwriters Laboratories Inc.,  File No. E28476

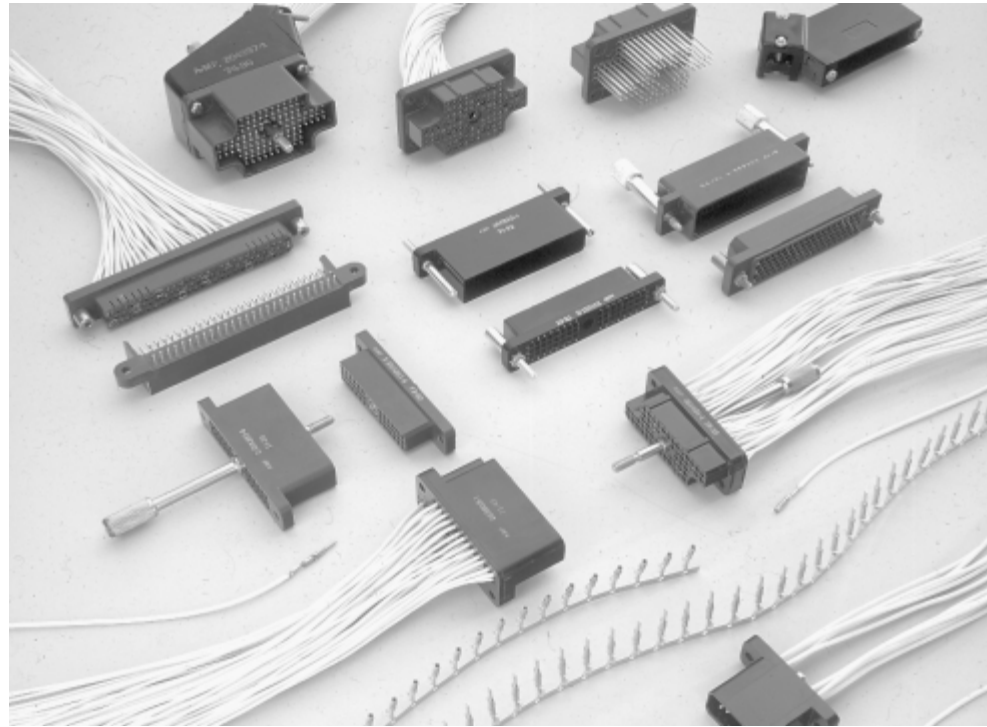

High Density Rectangular (HDR) connectors are designed in response to ever-increasing demands for miniaturization. The grid spacing of .100 x .100 [2.54 x 2.54] provides density for a connector accommodating a 20 thru 30 AWG [0.6 thru 0.05 mm²] wire range.

A variety of contact configurations and platings permits great design flexibility. Machine terminated, crimp snap-in contacts are available for the entire wire range. Also available are .025 [0.64] square posts on pin and socket contacts suitable for wrap-type wiring.

This unique connector is available in 12, 24, 36, 48, 54 and 106 positions in a rectangular housing. A special 95-position connector rounds out this group of rack and panel configured connectors.

A two piece, 80-position connector has been developed for printed circuit boards.

Versatility is designed into this family of connectors. Housings are available with or without center fasteners. Housing material for most connectors is diallyl phthalate or phenolic. When

mounting connectors with jackscrews, the receptacle half should be mounted to the chassis or panel. The turnable jackscrews should be positioned on the plug half containing the cable assembly.

Tooling for terminating leads is also available to meet production requirements. For limited production or prototype applications, the CERTI-CRIMP hand tool is ideal. Automatic machines are designed to fit various in-plant production needs.

Technical Features

- Available Number of Positions — 12, 24, 36, 48, 54, 106
- Center Spacing — .100 [2.54] x .100 [2.54]
- Housing material — Diallyl Phthalate or Phenolic
- Flammability Rating — UL 94V-0, UL File No. E28476
- Contact Material — Brass
- Contact Finish — .000030 [0.00076] Au
- Contact Size — 20
- Wire Size Range — 20–30 AWG

Termination Resistance —

AWG	Gold	Tin
20	8.0	16.5
24	14.5	27.0
26	22.0	—
30	48.0	—

Connector Mating Per Circuit — Gold 25 oz./Contact

Performance Characteristics Dielectric Withstanding Voltage — 1000 VAC

Insulation Resistance — DAP 50,000 megohms min. (initial), Phenolic 5000 megohms min. (initial)

Voltage Rating — 440 VAC Sea Level @ 3 Amp max.

Connector Mating/Unmating — Gold 25 oz. max., Tin 50 oz. max.

Contact Retention Force — DAP – 5.0 lb., Phenolic – 7.5 lb.

Durability — 500 Matings per Cycle Gold, 250 Matings per Cycle Tin

Temperature Range — DAP -85°F to 257°F [-65°C to 125°C], Phenolic -131°F to 302°F [55°C to 150°C]

Thermal Shock — DAP -85°F to 257°F [-65°C to 125°C], Phenolic -131°F to 302°F [55°C to 125°C]

Maximum Current — 3 Amp max.

Wire Size —

AWG	Test Current
20	3.0
24	2.25
26	1.75
30	1.00

Technical Documents

Product Specifications — Connectors/PC Board Headers – 108-10015

Application Specification — 114-10002

Instruction Sheet —

408-7357, 408-7472, 408-7484

Contacts

Type XI Crimp Snap-In Contacts

Contact Size — 20
Pin Diameter — .040 [1.02]

Plated as follows

A — .000030 [0.00076] gold over .000050 [0.00127] nickel
B — Gold flash over .000050 [0.00127] nickel on entire contact with additional .000030 [0.00076] gold in contact area
Contact Sleeve — Stainless Steel

Insertion Tool



Part Number 91042-1

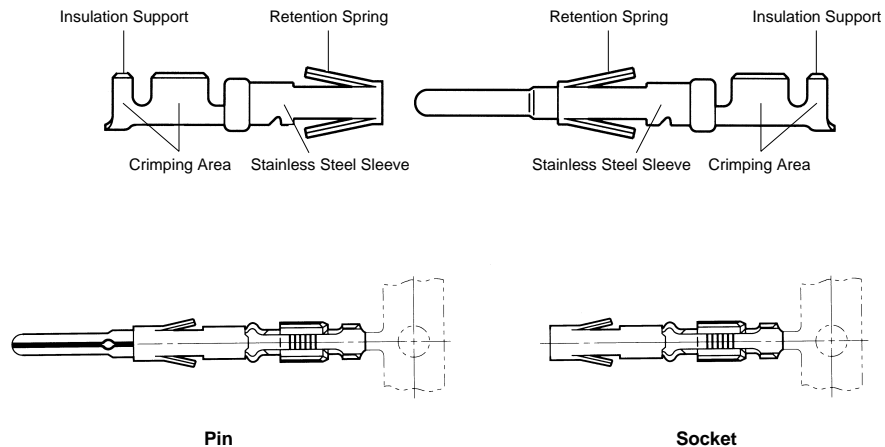

Wire Size Range AWG	Ins. Dia. mm ²	Contact Finish	Part Numbers				CERTI-CRIMP Hand Tool No.	Quick-Change Applicator No.	
			Strip Form		Loose Piece			AMP-O-ELECTRIC Machine Model G	AMP-O-MATIC Stripper/Crimper II Machine
			Pin	Socket	Pin	Socket			
20-24	0.6-0.2	.062 1.57	A	203816-1	203802-1	203816-3	203802-3	—	466904-1
			B	203816-2	203802-2	203816-4	203802-4		
26-30	0.15-0.05	.048 1.22	A	203874-1	203875-1	203874-3	203875-3	—	—
			B	203874-2	203875-2	203874-4	203875-4		

Wrap-Type Contacts with .025 x .025 [0.64 x 0.64] Posts

Contact Size — 20
Pin Diameter — .040 [1.02]

Plated as follows

A — .000030 [0.00076] gold over .000050 [0.00127] nickel
B — Gold flash over .000050 [0.00127] nickel on entire contact with additional .000030 [0.00076] gold in contact area
Contact Sleeve — Stainless Steel

Extraction Tool



Part Number 91038-3

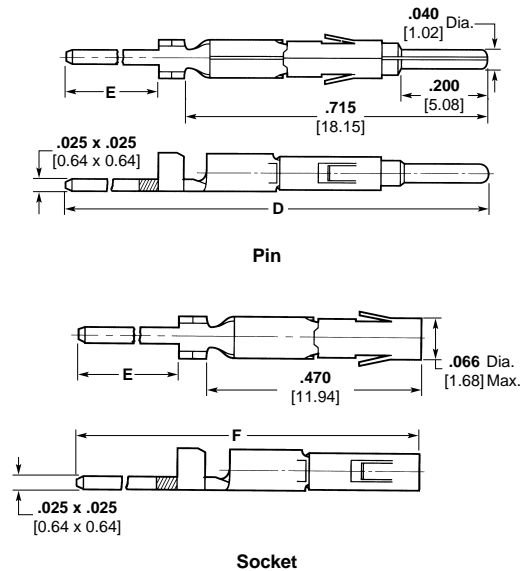

Max. Terminations Per Post	Dimensions			Contact Finish	Contact Part Numbers*	
	D	E	F		Pin	Socket
1	1.022	.257	.767	A	1-205171-0	1-205172-0
	25.96	6.53	19.48	B	205171-7	205172-7
2	1.236	.471	.981	A	1-205171-1	1-205172-1
	31.39	11.96	24.92	B	205171-8	205172-8
3	1.450	.685	1.195	A	1-205171-2	1-205172-2
	36.83	17.40	30.35	B	205171-9	205172-9

*Loose piece contacts for maintenance and repair only. Packaged 100 pieces per bag.

Housings

12, 24, 36, & 48 Positions

Material — See chart on page 5180

Related Product Data

Contacts — Page 5178

Accessories — Pages 5186 and 5187

Technical Documents — Page 5177

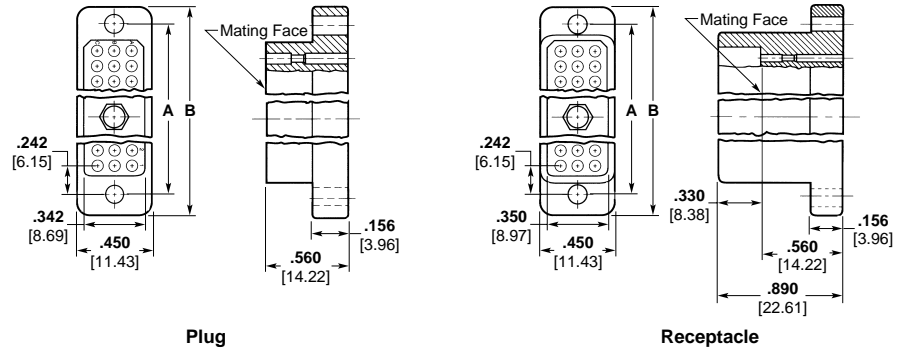

Plug

Receptacle

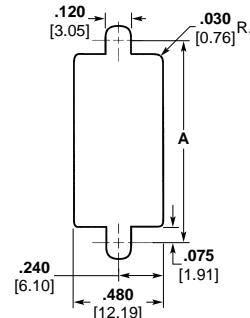

Recommended Panel Cutout

54 Position

Material — See chart on page 5180

Related Product Data

Contacts — Page 5178

Accessories — Pages 5186 and 5187

Technical Documents — Page 5177

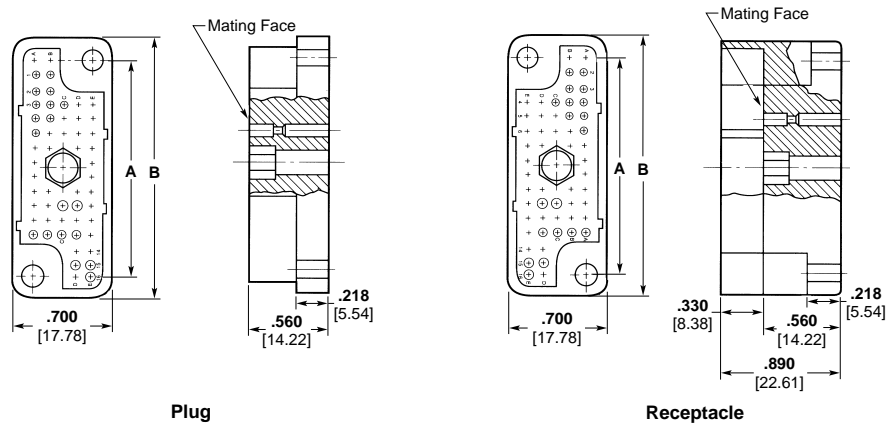

Plug

Receptacle

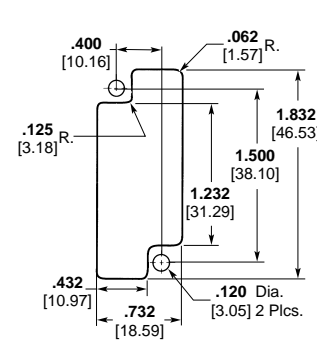
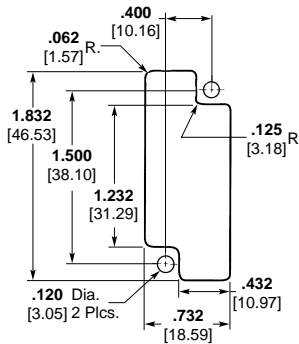

Recommended Panel Cutout

106 Position

Material — see chart below

Related Product Data

Contacts — Page 5178

Accessories — Pages 5186 and 5187

Technical Documents — Page 5177

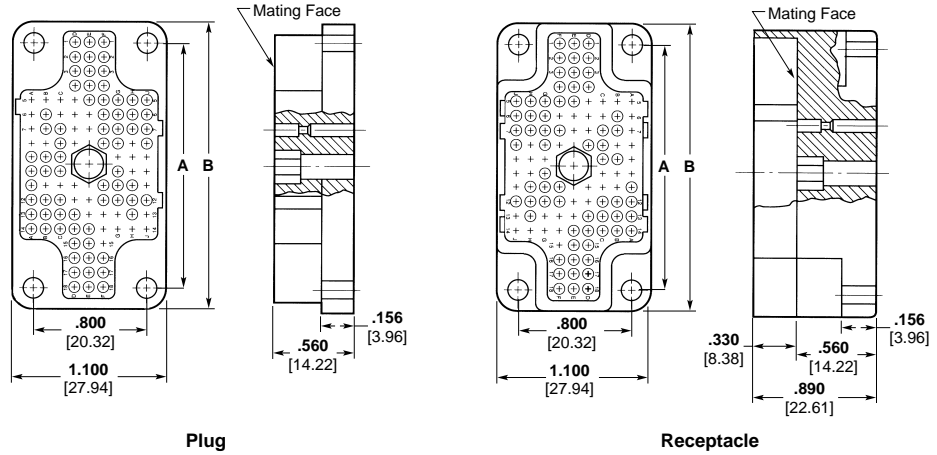
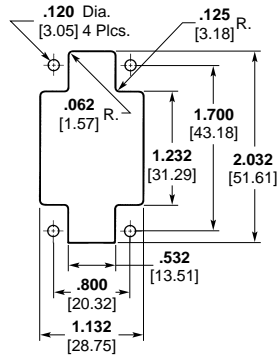

Recommended Panel Cutout

Center Fastener	No. of Positions	Dimensions		Center Fastener Type	Part Numbers			
		A	B		Plug Half		Receptacle Half	
					Phenolic	Diallyl Phthalate	Phenolic	Diallyl Phthalate
With Center Fastener	12	1.084 24.43	1.334 33.88	Fixed Female	204727-1	204727-2	—	204728-2
				Long Male Turnable	—	—	204740-1	204740-2
				Fixed Female	204729-1	204729-2	—	—
	24	1.484 37.69	1.734 44.04	Long Male Turnable	—	204741-2	204742-1	204742-2
				Short Male Turnable	—	—	—	204742-4
				Fixed Female	204731-1	204731-2	—	204732-2
	36	1.884 47.85	2.134 54.20	Long Male Turnable	204743-1	204743-2	204744-1	204744-2
				Short Male Turnable	204743-3	—	—	—
				Fixed Female	204733-1	—	204734-1	204734-2
	48	2.284 58.01	2.534 64.36	Long Male Turnable	—	204745-2	204746-1	204746-2
				Short Male Turnable	—	204745-4	—	—
				Fixed Female	204735-1	—	204736-1	—
54	1.500 38.10	1.800 45.72	Long Male Turnable	204747-1	204747-2	204748-1	204748-2	
			Short Male Turnable	—	—	—	204748-4	
			Fixed Female	204737-1	204737-2	204738-1	204738-2	
106	1.700 43.18	2.000 50.80	Long Male Turnable	204749-1	204749-2	204750-1	204750-2	
			Short Male Turnable	—	204749-4	—	204750-4	
			—*	204281-2	2-204281-2	204282-2	—	
Without Center Fastener	12	1.084 24.43	1.334 33.88	—*	—	2-204281-4	204282-4	2-204282-4
	24	1.484 37.69	1.734 44.04	—*	204281-6	2-204281-6	204282-6	2-204282-6
	36	1.884 47.85	2.134 54.20	—*	204281-8	2-204281-8	204282-8	—
	48	2.284 58.01	2.534 64.36	—*	203804-1	203804-2	203803-1	203803-2
	54	1.500 38.10	1.800 45.72	—*	204260-1	204260-2	204259-1	204259-2

*See page 5186 for jackscrews.

Housings (Continued)

95 Position Connector with Jackscrews

Material
 Housing — Diallyl Phthalate
 Jackscrews — Stainless Steel
Related Product Data
 Contacts — Page 5178
 Technical Documents — Page 5177

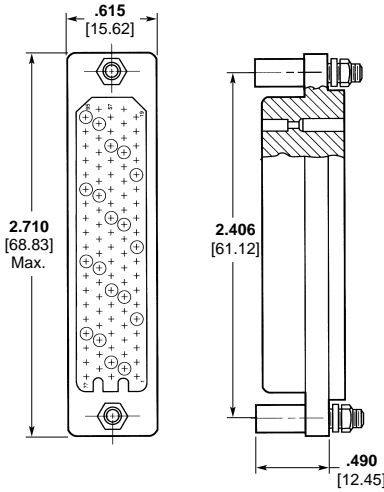

Plug
 Part Number 204694-1

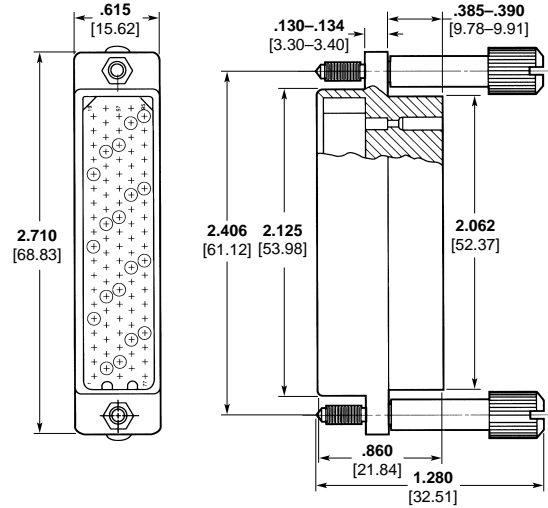

Receptacle
 Part Number 204693-2

95 Position Connector with Floating Bushings

Material
 Housing — Diallyl Phthalate
 Floating Bushings — Stainless Steel
Related Product Data
 Contacts — Page 5178
 Technical Documents — Page 5177

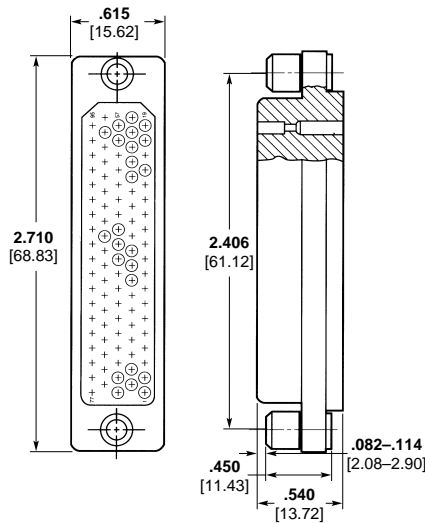

Plug
 Part Number 204030-1

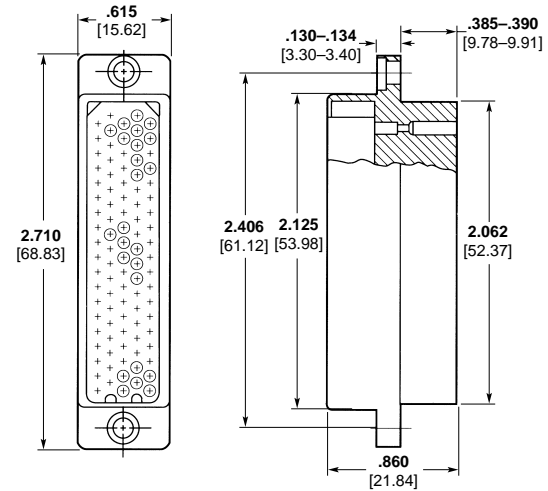

Receptacle
 Part Number 204027-2

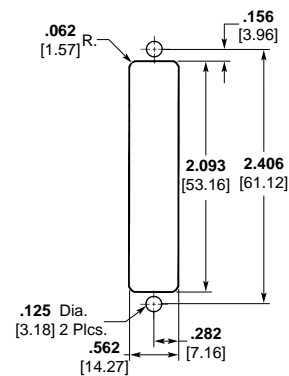

Recommended Panel Cutout

Note: Marking on receptacles are on wiring side only.

80 Position Pin Header

Material and Finish

Housing — Diallyl Phthalate
Contacts — Brass Plated .000030
 [0.00076] Gold over .000030 [0.00076]
 Nickel

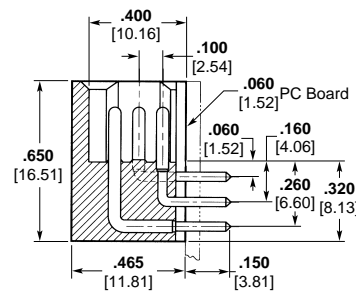
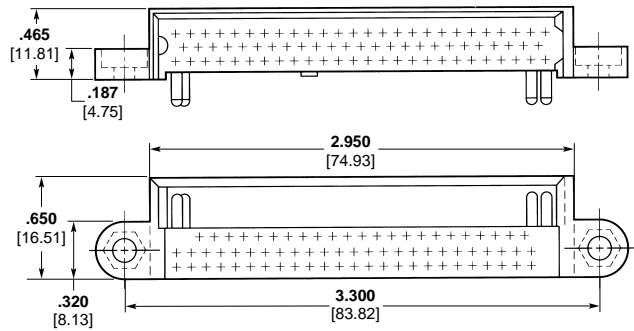

Part Number 204818-4

80 Position Plug with Floating Bushings

Material and Finish

Housing — Diallyl Phthalate
Floating Bushings — Stainless Steel

Related Product Data

Contacts — Page 5178
Technical Documents — Page 5177

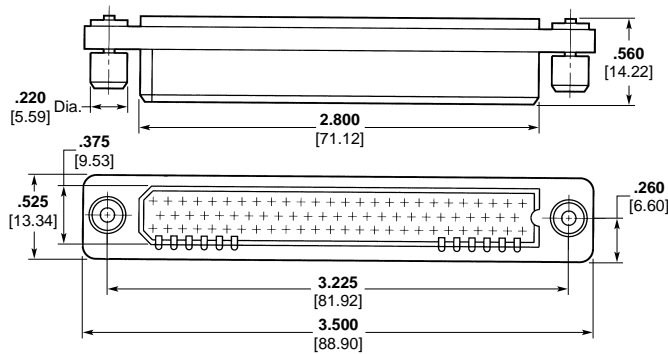

Part Number 204819-1

Preloaded Housings, .025 x .025 [0.64 x 0.64] Posted Contacts for Automatic Wiring

12, 24, 36, & 48 Position

Material and Finish

Housing — See Chart

Contact Body —

Brass Plated as follows

A — .000030 [0.00076] Gold over .000050 [0.00127] Nickel

B — Gold Flash over .000050 [0.00127] Nickel on entire contact, with additional .000030 [0.00076] Gold in contact area

Contact Sleeve — Stainless Steel

Related Product Data

Contact Size — 20

Pin Diameter — .040 [1.02]

Current Rating — 3.0 Amperes (20 AWG [0.5–0.6 mm²] wire)

Replacement Contacts — Page 5178

Mateable Connectors — Pages 5179 and 5180

Technical Documents — Page 5177

Plug Assembly

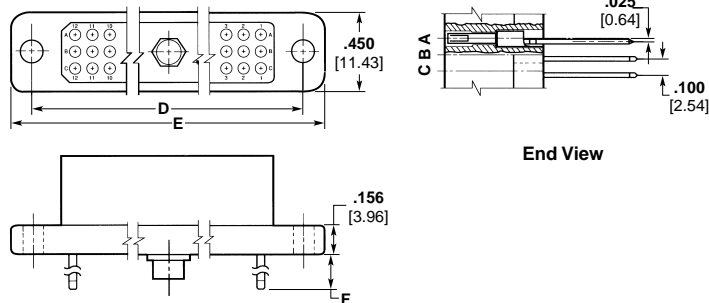

Receptacle Assembly

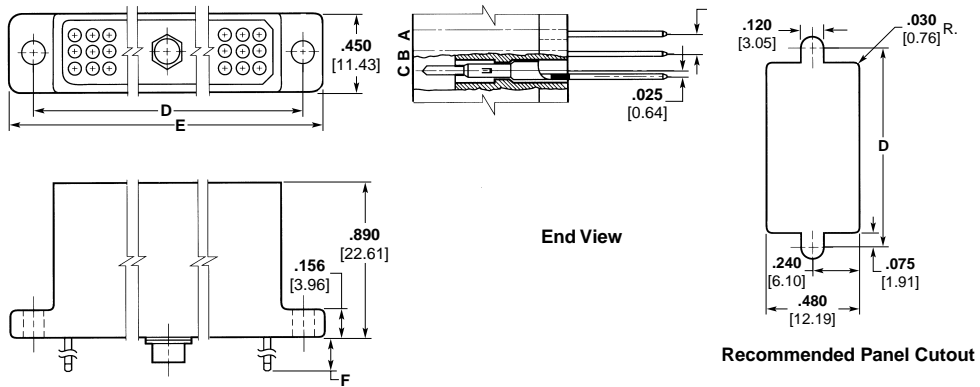

No. of Positions	Dimensions D E		Contact Finish	Max. Termination Per Post	Dim. F	Part Numbers			
						Plug Assembly Socket Contacts		Receptacle Assembly Pin Contacts	
						Phenolic	Diallyl Phthalate	Phenolic	Diallyl Phthalate
12	1.084 27.43	1.334 33.88	A	1	.242 6.15	—	—	—	2-204682-8
				3	.670 17.02	—	—	—	3-204682-0
24	1.484 37.69	1.734 44.04	A	1	.242 6.15	—	6-204683-4	1-204684-9	—
				3	.670 17.02	—	6-204683-6	2-204684-1	3-204684-0
			B	1	.242 6.15	6-204683-1	7-204683-0	—	—
				3	.670 17.02	6-204683-3	—	2-204684-7	—
36	1.884 48.85	2.134 54.20	A	1	.242 6.15	—	—	1-204686-9	2-204686-8
				3	.670 17.02	5-204685-7	6-204685-6	—	3-204686-0
			B	1	.242 6.15	—	—	—	3-204686-4
				3	.670 17.02	6-204685-3	7-204685-2	—	3-204686-6
48	2.284 58.01	2.534 64.36	A	1	.242 6.15	5-204687-5	—	—	2-204688-8
				3	.670 17.02	5-204687-7	6-204687-6	—	3-204688-0
			B	1	.242 6.15	—	7-204687-0	—	—
				3	.670 17.02	6-204687-3	7-204687-2	—	—

- Notes:**
1. Markings on receptacle assembly are on wiring side only.
 2. In addition to combinations listed, all sizes are available with or without female jackscrews. Plugs are available with pins, and receptacles are available with sockets. Consult Tyco Electronics for details.
 3. Fixed female jackscrews are included with these assemblies.

Preloaded Housings, .025 x .025 [0.64 x 0.64] Posted Contacts for Automatic Wiring (Continued)

54 Position

Plug Assembly

Material and Finish

Housing — See Chart

Contact Body —

Brass Plated as follows
A — .000030 [0.00076] Gold over
 .000050 [0.00127] Nickel

B — Gold Flash over .000050
 [0.00127] Nickel on entire contact, with
 additional .000030 [0.00076] Gold in
 contact area

Contact Sleeve — Stainless Steel

Related Product Data

Contact Size — 20

Pin Diameter — .040 [1.02]

Current Rating — 3.0 Amperes
 (20 AWG [0.5–0.6 mm²] wire)

Replacement Contacts — Page 5178

Mateable Connectors — Pages 5179
 and 5180

Technical Documents — Page 5177

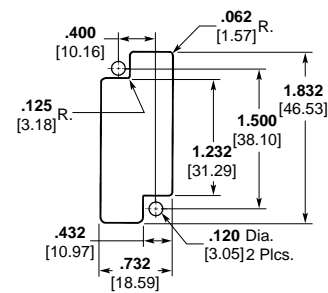
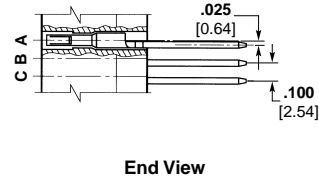
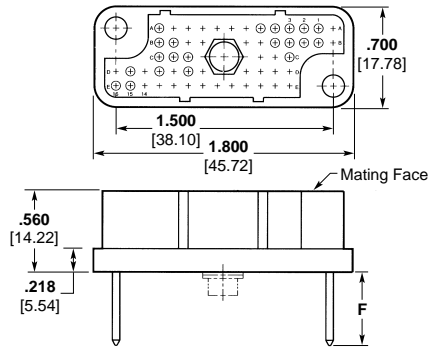

Recommended Panel Cutout for Receptacle

Receptacle Assembly

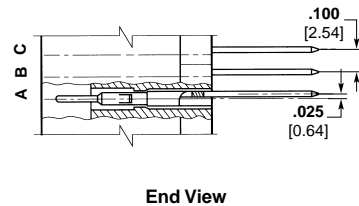
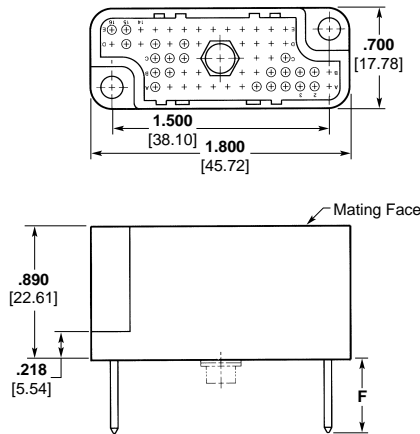

Contact Finish	Max. Termination Per Post	Dim. F	Part Numbers			
			Plug Assembly Socket Contacts		Receptacle Assembly Pin Contacts	
			Phenolic	Diallyl Phthalate	Phenolic	Diallyl Phthalate
A	1	.242 6.15	5-204689-5	6-204689-4	1-204690-9	—
	2	.456 11.58	5-204689-6	6-204689-5	—	—
	3	.670 17.02	5-204689-7	6-204689-6	2-204690-1	3-204690-0
B	1	.242 6.15	6-204689-1	—	—	—
	3	.670 17.02	—	7-204689-2	2-204690-7	—

- Notes:** 1. Markings on receptacle assembly are on wiring side only.
 2. In addition to combinations listed, all sizes are available with or without female jackscrews. Plugs are available with pins, and receptacles are available with sockets. Consult Tyco Electronics for details.
 3. Fixed female jackscrews are included with these assemblies.

Preloaded Housings, .025 x .025 [0.64 x 0.64] Posted Contacts for Automatic Wiring (Continued)

106 Position

Material and Finish

Housing — See Chart

Contact Body —

Brass Plated as follows

A — .000030 [0.00076] Gold over .000050 [0.00127] Nickel

B — Gold Flash over .000050 [0.00127] Nickel on entire contact, with additional .000030 [0.00076] Gold in contact area

Contact Sleeve — Stainless Steel

Related Product Data

Contact Size — 20

Pin Diameter — .040 [1.02]

Current Rating — 3.0 Amperes (20 AWG [0.5–0.6 mm²] wire)

Replacement Contacts — Page 5178

Mateable Connectors — Pages 5179 and 5180

Technical Documents — Page 5177

Plug Assembly

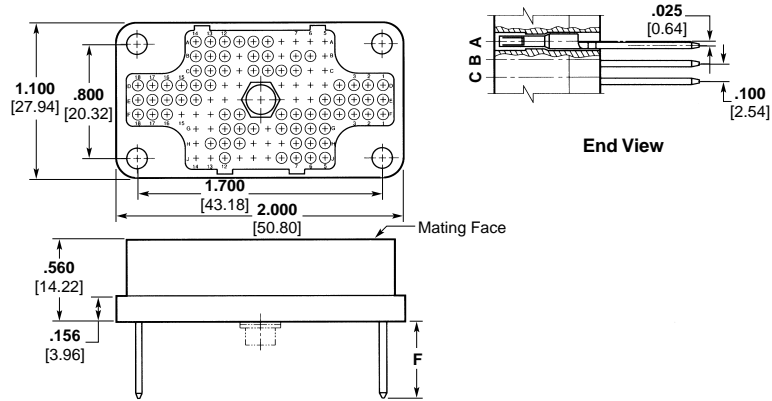

Receptacle Assembly

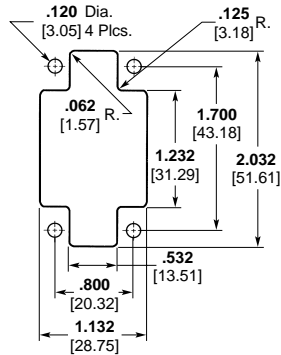
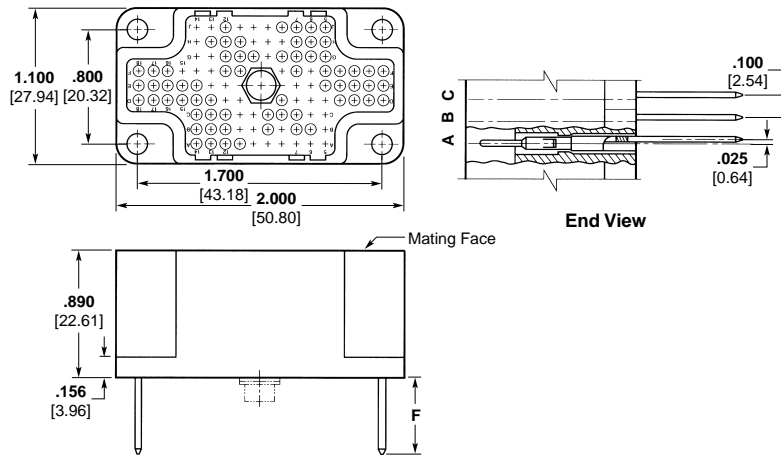

Recommended Panel Cutout

Contact Finish	Max. Termination Per Post	Dim. F	Part Numbers			
			Plug Assembly Socket Contacts		Receptacle Assembly Pin Contacts	
			Phenolic	Diallyl Phthalate	Phenolic	Diallyl Phthalate
A	1	.242 6.15	5-204691-5	—	—	2-204692-8
	3	.670 17.02	5-204691-7	6-204691-6	2-204692-1	3-204692-0
B	1	.242 6.15	6-204691-1	7-204691-0	—	3-204692-4
	3	.670 17.02	6-204691-3	7-204691-2	2-204692-7	3-204692-6

- Notes:**
1. Markings on receptacle assembly are on wiring side only.
 2. In addition to combinations listed, all sizes are available with or without female jackscrews. Plugs are available with pins, and receptacles are available with sockets. Consult Tyco Electronics for details.
 3. Fixed female jackscrews are included with these assemblies.

Accessories

Center Fasteners

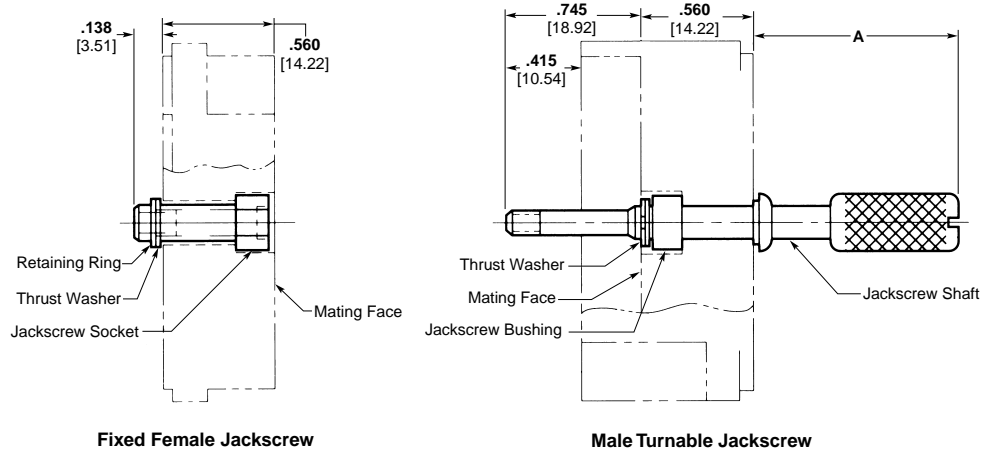

No. of Positions	Type	A	Part No.
12, 24 36, 48	Fixed Female	—	204299-1
	Short Male Turnable	1.01 25.65	204298-1
	Long Male Turnable	1.76 44.70	204298-2
54, 106	Fixed Female	—	203879-1
	Short Male Turnable	1.01 25.65	203880-1
	Long Male Turnable	1.76 44.70	203880-2

Note: Short male jackscrews cannot be used with shield and cable clamp assemblies.

Keying

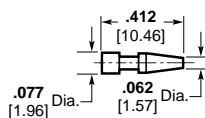
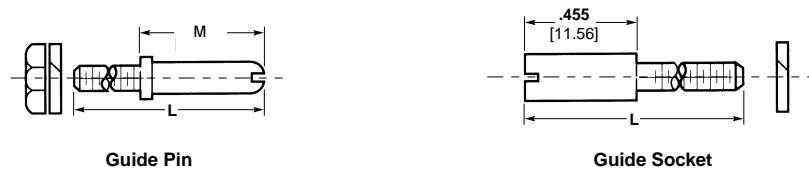

Material	Pin			Socket	
	Dim. L	Dim. M	Part No.	Dim. L	Part No.
Zinc Plated Brass	1.100 27.94	.515 13.08	203881-1	1.045 26.54	203882-1
Stainless Steel	1.100 27.94	.515 13.08	203881-2	1.045 26.54	203882-2
Zinc Plated Brass	1.300 33.02	.725 18.42	205694-1	—	—

Keying Plug

Part Number 205120-1

Accessories (Continued)

45° Shield and Cable Clamps

Material — Black Polysulfone

12, 24, 36 & 48 Position

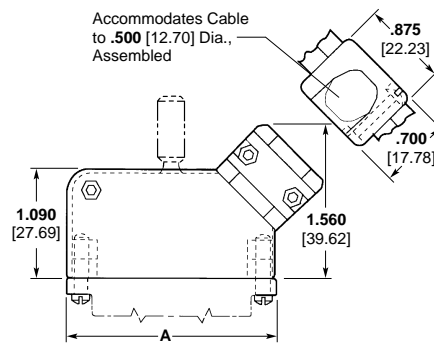

No. of Positions	Dim. A	Part No.
12	1.334 33.88	205083-1
24	1.734 44.04	205083-2
36	2.134 54.20	205083-3
48	2.534 64.36	205083-4

54 Position

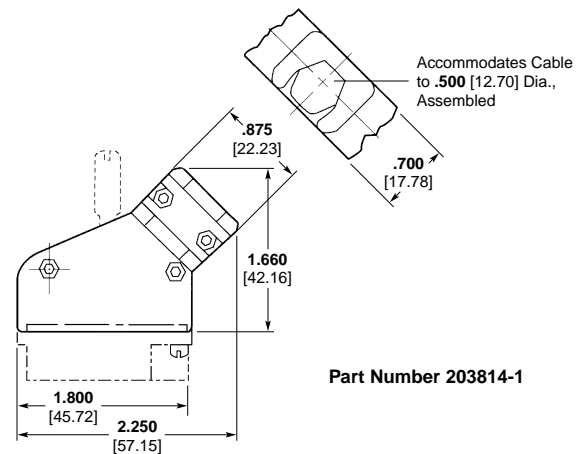

Part Number 203814-1

106 Position

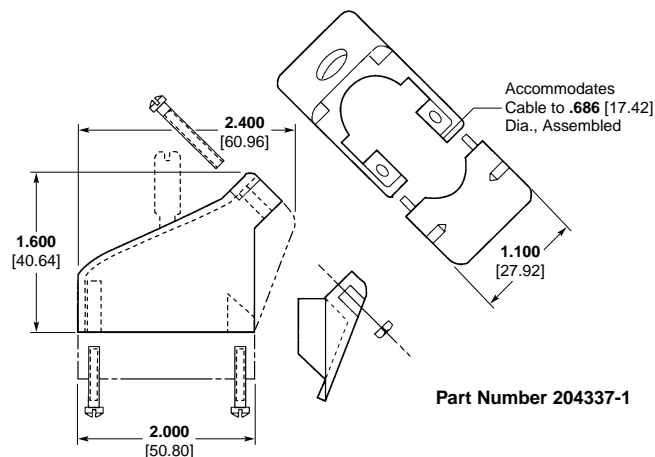

Part Number 204337-1

Type XI crimp/snap-in contacts may be applied with hand tools, semi-automatic bench equipment or fully-automatic lead-making machines.

CERTI-CRIMP II Straight Action Hand Tools (SAHT)



Premium grade hand tools. Feature ratchet control to provide complete crimp cycle. Die sets close in a straight line. Include a contact locator and wire stop, plus an insulation crimp adjustment lever, when applicable. Approximate weight 1.3 lb [0.59 kg].

Application Tooling

AMP-O-LECTRIC Model "K" Terminating Machine, 1-471273-3



Semiautomatic bench machine for use with standard-style applicators. It is an electrically-powered, clutched, flywheel-energy-style machine, equipped with a mechanical strip feed mechanism. Products commonly applied with this machine include AMP splices, AMPLIVAR splices, and FASTON flag receptacles.

Specifications

Width — 21 [533]

Depth — 20 [508]

Height — 24 [610] without reel

Weight — 230 lb [104 kg]

Electrical — 120 VAC, 60 Hz, 6 A

Air — 90-110 psi [6.21-7.59 bar], 6 scfm [0.00282 m³/s] when required with air-feed applicators

Wire Range — 26-10 AWG [0.12-6 mm²] solid or stranded, depending on product applied

For more information, contact Tyco Electronics.

AMPOMATOR CLS IV+ Lead-Making Machines, 356500-1, -2



Fully-automatic machines that measure, cut, strip and terminate single leads. Microprocessor-controlled, and programmed and operated using an easy-to-follow, menu-driven touch-screen. Features include direct-drive terminating units with precision crimp height adjustment, fully programmable setups, wire runout and splice detection, and motorized pre-feed with wire straightener. Crimp quality monitoring is also available.

Specifications

Width — 159 [4 040]

Depth — 68 [1 730]

Height — 86 [2 185] with 24 [610] dia. reel

Weight — 2 000 lb [907 kg]

Electrical — 220 VAC, 50 or 60 Hz, single phase, 25 A, with neutral and ground

Air — 90 psi [6.21 bar], 15 scfm [0.0071 m³/s] sustained

Wire Range — 26-10 AWG [0.12-6 mm²] stranded, 26-16 AWG [0.12-1.4 mm²] solid

Lead Lengths — 3-90

[76.2-2 285], 90-1 000 [2 285-25 400] with long lead conveyors

For more information, request Catalog 124324.

Crimp Quality Monitor (CQM), 1320420-1, -2



This unique system provides 100% on-the-fly crimp inspection. It measures the crimp height of each termination, and evaluates the quality of each crimp. If a crimp is questionable, the monitor alerts the operator with both visual and audible alarms. It also provides ports for printing and networking. When used with AMP-O-LECTRIC Model "G" Termination Machines, the monitor is mounted to the machine. When used with AMPOMATOR CLS IV+ Lead-Making Machines, it is integrated into the machine's operating system.

Specifications

Width — 8.8 [220]

Depth — 8.1 [205]

Height — 4.6 [115]

Weight — 5 lb [2.3 kg]

Electrical — 100-240 VAC, 50/60 Hz, 3.2 A

For more information, request Catalog 82275.

Application Tooling (Continued)

AMP-O-LECTRIC Model "G" Terminating Machines, 354500-1, -9, -11



Semiautomatic bench machines for crimping reeled terminals and contacts, featuring a quiet and reliable direct motor drive, microprocessor controls for ease of setup and operation, and guarding and lighting designed for operator convenience. All models are equipped with either manual or automatic precision adjustment of crimp height. Machine-mounted sensors are available for crimp quality monitoring using conventional miniature-style applicators.

Specifications

Width — 18.7-25.3 [475-643] depending on applicator type
Depth — 21.5-28.1 [546-713] depending on applicator type
Height — 20 [508]
Weight — 240 lb [110 kg]
 Electrical — 120 or 220 VAC, 50 or 60 Hz; 310 VA
Air — 90-110 psi [6.21-7.59 bar], 6 scfm [0.00282 m³/s] when required with air-feed applicators
Wire Range — 26-10 AWG [0.12-6 mm²] solid or stranded, depending on product applied
 For more information, request Catalog 65828.

Entry Level Terminator (ELT), 1338600-1, -2, -3, -4, -5, -6

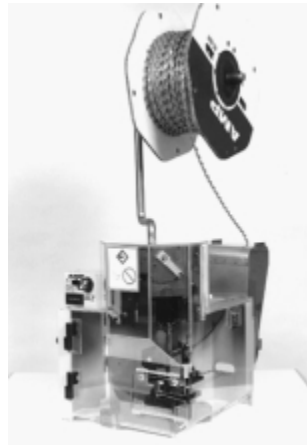

Semiautomatic Bench Terminator for side- and end-feed reeled terminals and contacts. The ELT uses a DC motor with gear box drive. The result is a small-footprint design that is fast and quiet. Cycle time is less than 0.400 seconds with an operation sound level of 76dBA. With a crimp force capacity of 3,000 pounds, the ELT is available for all but the highest crimp force applications. A wide range of optional equipment is also available to meet your specific application requirements.

Specifications

Width — 16.8 [427]
Depth — 20.6 [523]
Height — 20 [510] without reel support
Weight — approx. 150 lb [68 kg]
Electrical — 100-240 VAC, 50/60 Hz, 6A (Note: Avg <1 A at 120 VAC when used as a bench-top unit at 2,000 cycles per hour operating rate)
Air — 90-100 psi [6.21-6.90 bar], 6 scfm [0.00282 m³/s] when required for use with air-feed applicators (Note: Optional Air Feed Valve Assembly Required)
Wire Range — Up to 14 AWG [2.5 mm²]
 For more information, request catalog 1308382.

AMP-O-MATIC Stripper/Crimper Machine, 1320895-1



Semiautomatic bench crimping machines that also strip the wire, and are therefore used for terminating jacketed cable. Feature manual precision adjustment of crimp height, keyed strip blades for faster, more accurate setups, and an efficient scrap removal system. All adjustments can be made from the front of the machines without special tools. Available with crimp quality monitoring.

Specifications

Width — 14 [355]
Depth — 18 [457]
Height — 33 [838] without reel
Weight — 150 lb [68 kg]
Electrical — 120 VAC, 50 or 60 Hz, 5 A
Air — 80-100 psi [5.52-6.90 bar], 3.5 scfm [0.00165 m³/s]
Wire Range — 32-14 AWG [0.03-2 mm²]
 For more information, request Catalog 65004.

Stripping Module

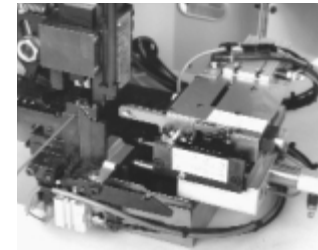

The combination of the Stripping Module with the Entry Level Terminator (ELT) or the AMP-O-LECTRIC Model G Terminator provides an economical and proficient method of stripping wire and crimping terminals on the same machine. Wires are stripped during handling or storage. Once the wire is fed into the start sensor the Stripping Module does the rest, improving placement accuracy.

Specifications

Wire Range Base Module — 0.03 mm² - 2.0 mm² (32-14 AWG) (30-32 AWG may require special kit.)
Max. Insulation — .200 [5.08]
Cable Breakout — > 1.100 [29.00]
Strip Length — .100 - .400 [2.50 - 10.16]
Noise — Less than 82 dBA (Typical at operator position with standard mechanical feed applicator)
Weight — 4.53 Kilograms (10 lb)
Height — 5.000 [127.00]
Electrical — 100-240 VAC, 50/60 Hz, single phase current, obtains power from the terminator
Air — 620-760 kPa (90-100 psi), 2.83 liters/sec (6 scfm)
Wire Sensor — Gold plated contacts with laser etched target
 For more information, request Catalog 1309085.

Introduction

Product Facts

- Low-profile rectangular design for high packaging density
- Environmental sealing for aerospace applications
- Modular components for design versatility and logistics savings
- Lightweight materials for weight savings
- Quick-disconnect mating hardware

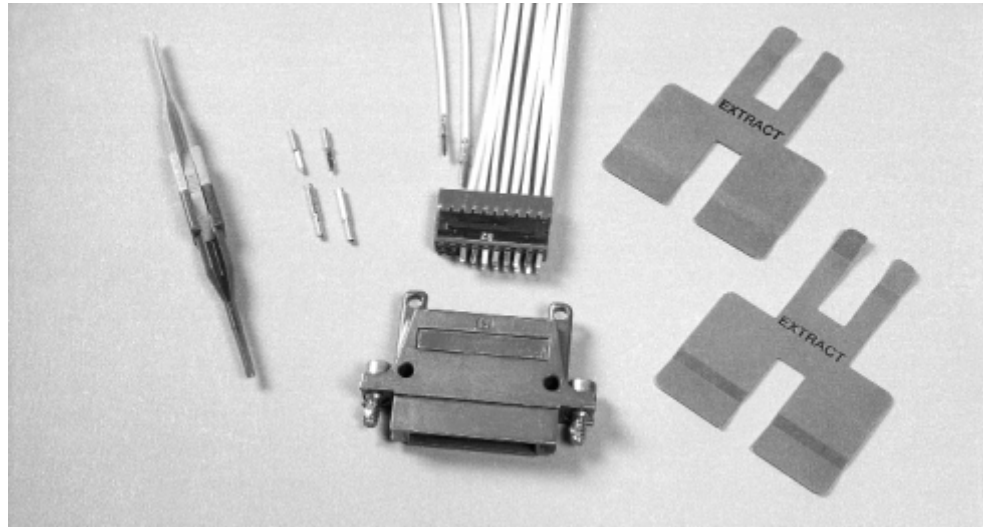
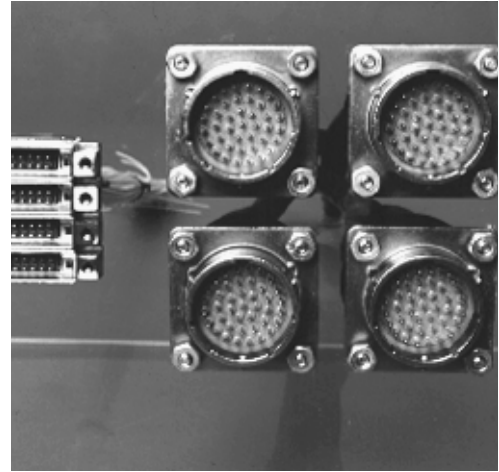
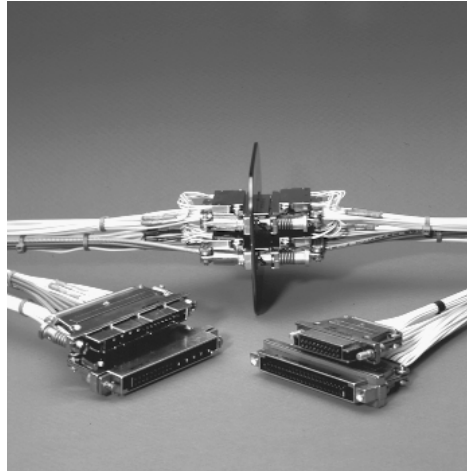

METRIC
Dimensions in this section are millimeters over inches

System

The Raychem MTC product line is a complete modular connector system consisting of lightweight, environmentally sealed miniature rectangular connectors (shell housings with removable inserts) and individually removable rear-release contacts.

Components

MTC connectors are now available with quick-disconnect mating hardware, EME shielding accessories, and modular inserts that can accommodate a mix of signal and power crimp contacts and coaxial contacts. The need for special termination tooling has

been minimized, while the ease of manufacturing and maintenance has been improved.

Configurations

MTC rectangular connectors using jack screws or quick-disconnect hardware can be stacked or panel-mounted next to each other without any provision for grip space, a feature that can save significant panel area.

MTC connectors are available in 1-inch and 2-inch configurations. Modular removable inserts with size 22 and/or size 16 contact cavities can be combined into the 1-inch and 2-inch MTC housings.

Inserts

MTC inserts are available in 20-cavity and 5-cavity versions. The 20-cavity insert accepts size 20-22 (24 AWG to 20 AWG wire) crimp contacts. The 5-cavity insert accepts size 16-14 crimp contacts. Insertion/extraction of the contacts is rear release.

Note:

Other configurations are available in the MTC family (size 12 contacts; 50 mil spacing for double density; accessories). Please contact Tyco Electronics.

20-Cavity Inserts

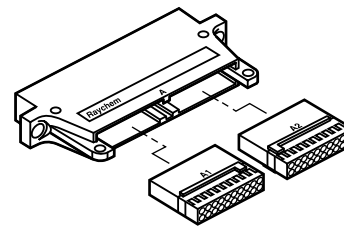

2-inch shell with inserts

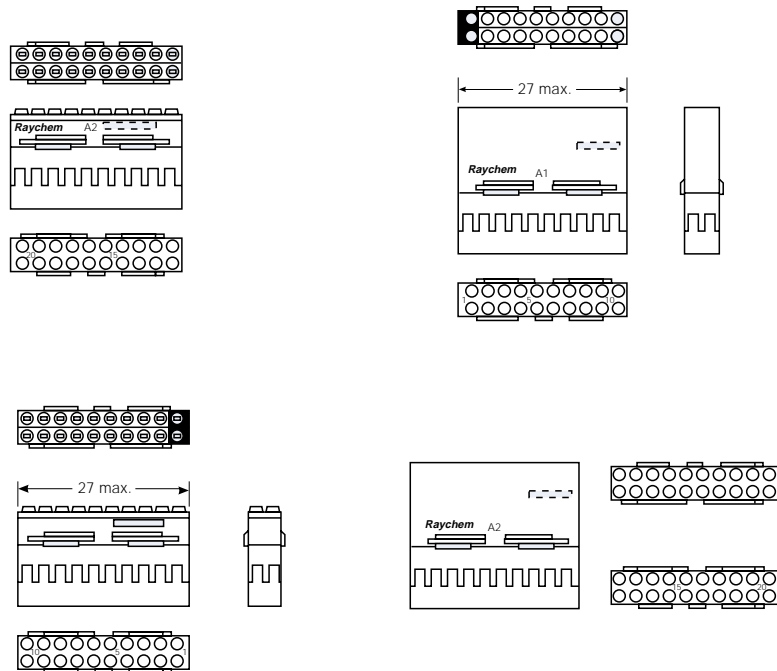

MTCP-122-20 inserts are used with MTC100 1-inch and 2-inch shells. The 1-inch shell takes:

- One MTCP-122-20P (pin contact) **or**
- One MTCP-122-20S (socket contact)

The 2-inch shell takes:

- One MTCP-122-20P1 and one MTCP-122-20P2 (pin contact) **or**
- One MTCP-122-20S1 and one MTCP-122-20S2 (socket contact)

2 x 20 Cavity Inserts
(Size 20-22)—2-Inch Shell

Pin Insert	Socket Insert
MTCP-122-20P1	MTCP-122-20S1
MTCP-122-20P2	MTCP-122-20S2

1 x 20 Cavity Inserts (Size 20-22)—1-Inch Shell

20-Cavity Inserts (Continued)

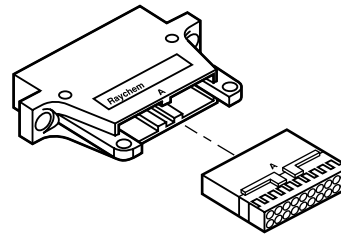

1-inch shell with insert

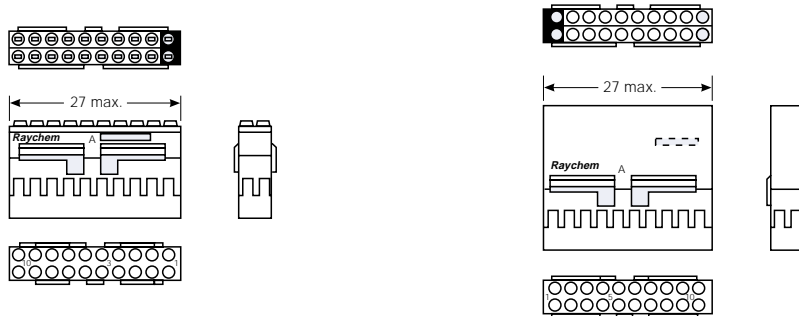

Pin Insert	Socket Insert
MTCP-122-20P	MTCP-122-20S

Contacts for 20-Cavity Inserts

The contacts for 20-cavity inserts must be ordered separately. They are:

- CTA-0166—pin contact
- CTA-0165—socket contact

Contacts accept 24 AWG to 20 AWG wires.

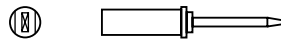

**Pin Contact
CTA-0166**

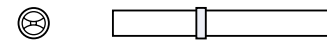

**Socket Contact
CTA-0165**

Tools		Tools	
Positioner for pin contact	CE-1605900	Positioner for socket contact	CE-1606000
Installation process	ES-61413	Installation process	ES-61413
Contact removal tool (plastic)	CTA-1160	Contact removal tool (plastic)	CTA-1160
Extraction tool for MTCP inserts	CTA-0161	Extraction tool for MTCP inserts	CTA-0161

5-Cavity Inserts

5-Cavity Inserts (Size 16)

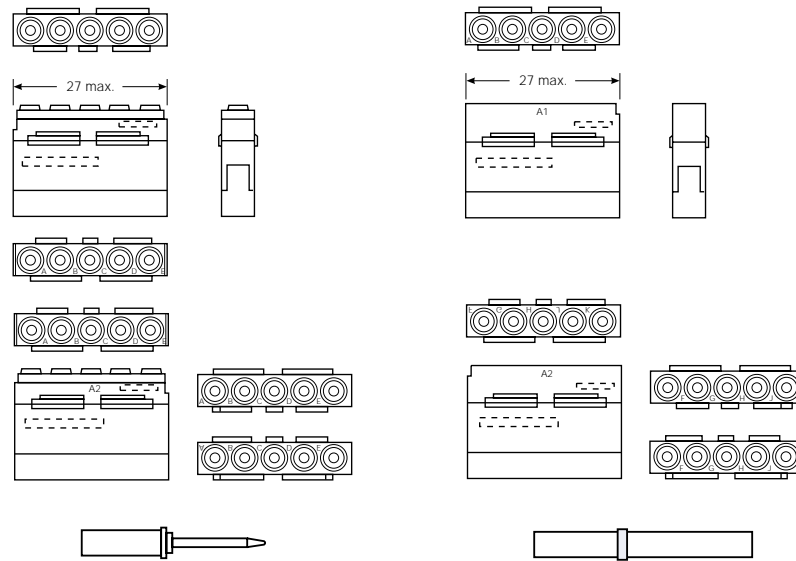

MTCP-116-05 inserts are used with MTC100 1-inch and 2-inch shells. The 1-inch shell takes:

- One MTCP-116-05-P1 (pin contact) **or**
- One MTCP-116-05-S1 (socket contact)

The 2-inch shell takes:

- One MTCP-116-05P1 and one MTC-116-05P2 (pin contact) **or**
- One MTCP-116-05-S1 and one MTCP-116-05-S2 (socket contact)

5-Cavity Inserts (Size 16)

Pin Insert	Socket Insert
MTCP-116-05P1	MTCP-116-05S1
MTCP-116-05P2	MTCP-116-05S2

Contacts for 5-Cavity Inserts

The contacts for 5-cavity inserts must be ordered separately. They include:

- CTA-0079 - pin contact (MS 27493-16) (MIL-C-39029/58 intermateable)
- CTA-0078 - socket contact (MS 27491-16) (MIL-C-39029/57 intermateable)
- D-602-0140 - coaxial pin contact (MIL-C-39029/76 intermateable)
- D-602-0171 - coaxial socket contact (MIL-C-39029/78 intermateable)

Other contacts designed for M38999 Series II connectors can be used.

Pin Contact	Socket Contact
D-602-0140 (coaxial)	D-602-0171 (coaxial)
CTA-0079 (power)	CTA-0078 (power)

Hybrid Inserts

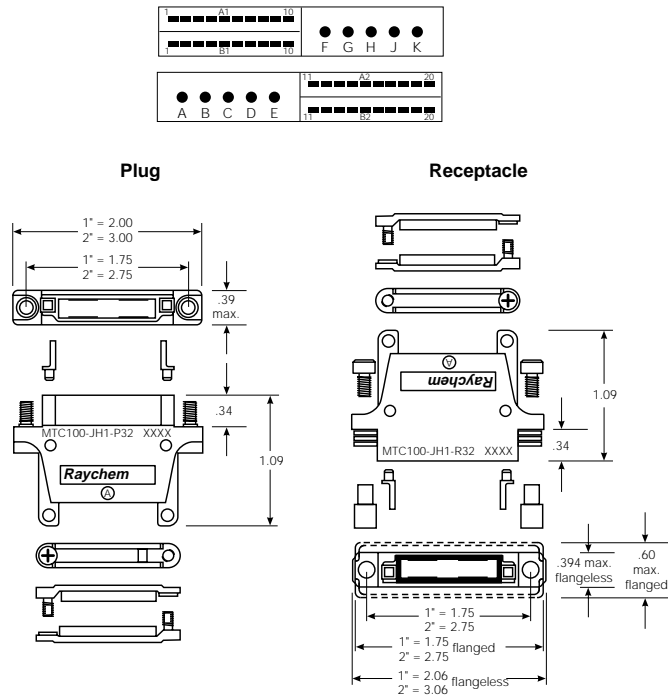

Hybrids

Hybrid insert combinations of size 22 and size 16 contact cavities are also possible.

2-Inch Shell—Hybrid Assembly

Power and signal

Shells

MTC connector housing shells are available with nickel plating (48-hr salt spray performance) or cadmium over nickel plating (500-hr salt spray performance).

MTC connector housings are offered with quick-disconnect or jack-screw mating hardware. Each connector shell is polarized and has 64 user-defined keying combinations. Lightweight, low-profile EME backshells are also available for increased shielding effectiveness of the connector.

MTC Shells Ordering Information

M T C 1 0 0 X - X H X - X X 2

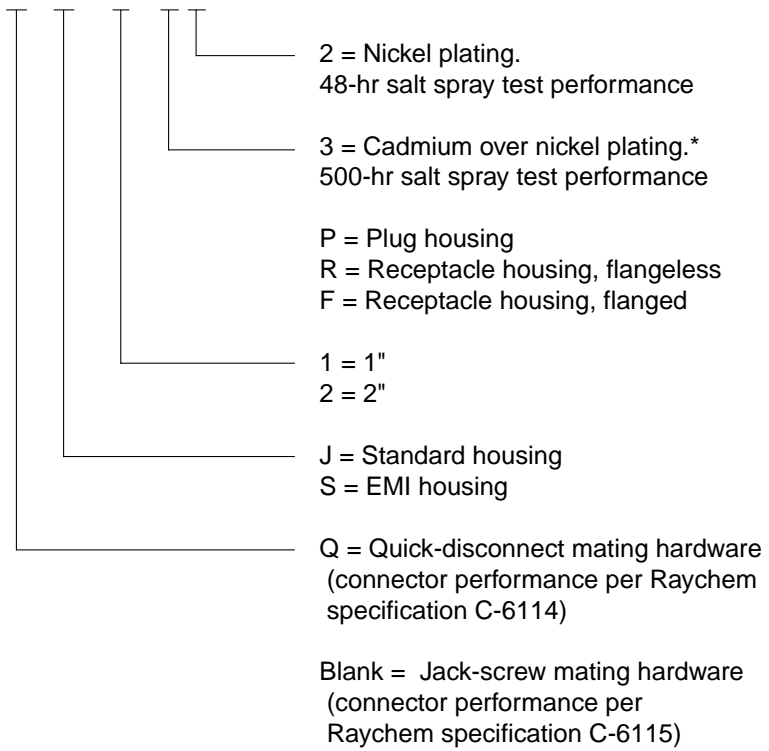

*Some combinations of shells, mating hardware and EME shielding accessories are not available.
Contact Tyco Electronics for product information.

Accessories

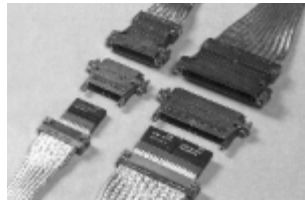

Low-Profile EME Backshells

Lightweight rectangular EME backshells connect the overall bundle shield to the MTC connector housing. Individual cable shields can also be terminated to the backshell braid by using Raychem SolderSleeve devices.

The backshell is mounted on the MTC housing via the cable clamp screws.

MTC backshell features include a low profile, light weight, and Level II EME performance.



EME Backshell Adapters

CHA-0275 2-inch adapter (plug or receptacle)

CHA-0276 1-inch adapter (plug or receptacle)

MTC shield-grounding busbars Raychem MTC shield-grounding busbars allow for simple, cost-effective termination of cable shielding to MTC aluminum housings.

Two-inch shield-grounding busbars terminate up to 20 shielded twisted pairs on a 2-inch MTC connector. The individual shields are terminated to "fingers" on the busbar with Raychem SolderSleeve devices.

The busbar is mounted on the MTC housing via cable clamp screws.

MTC busbar features include a simple termination, cost effectiveness, light weight, and Level I EME performance.

Shield-Grounding Busbars

CTA-0022 1-inch busbar (with 5 SolderSleeve terminators)

CTA-0023 2-inch busbar (with 10 SolderSleeve terminators)

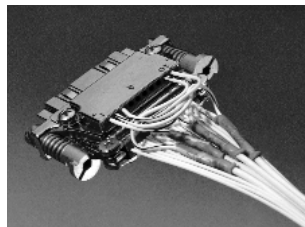

EME Shielding Accessories for MTC Connectors

Grounding Block

Allows for cable shield termination grounding on the MTC shell housing via crimp-removable contacts. This grounding scheme allows individual cables to be removed from the connector without cutting a ganged ground connection. Sufficient ground contacts are available to handle shielded twisted-pair cables.

CHA-0301 1-inch grounding block receptacle shell

CHA-0302 2-inch grounding block receptacle shell

CHA-0303 1-inch grounding block plug shell

CHA-0304 2-inch grounding block plug shell

Introduction

Product Facts

- The TJS connections are inherently more reliable than conventional threaded and solder terminations.
- The user's wiring is crimped to gold plated pin contacts, conforming to MIL-C-39029/1, which are individually mated to probe-proof gold plated pre-bussed sockets contained within the module and splice.
- Modules and Splices — environment proof conforming to the requirements of MIL-T-81714. These modules can be assembled into MIL-T-81714 rails and are individually removable. Brackets are also available to mount individual or triads of modules. The splices are designed to terminate from two to four wires.
- Commercial TJS consists of module blocks (either environmental or non-environmental) designed for custom assembled installations. These can be furnished in pre-assembled arrays in rails or individually with rail kits to accommodate various rows and lengths of modules.
- TJS Connectors also qualified to German Army Standard VG 95212-31/ VG 95231-102/103/105

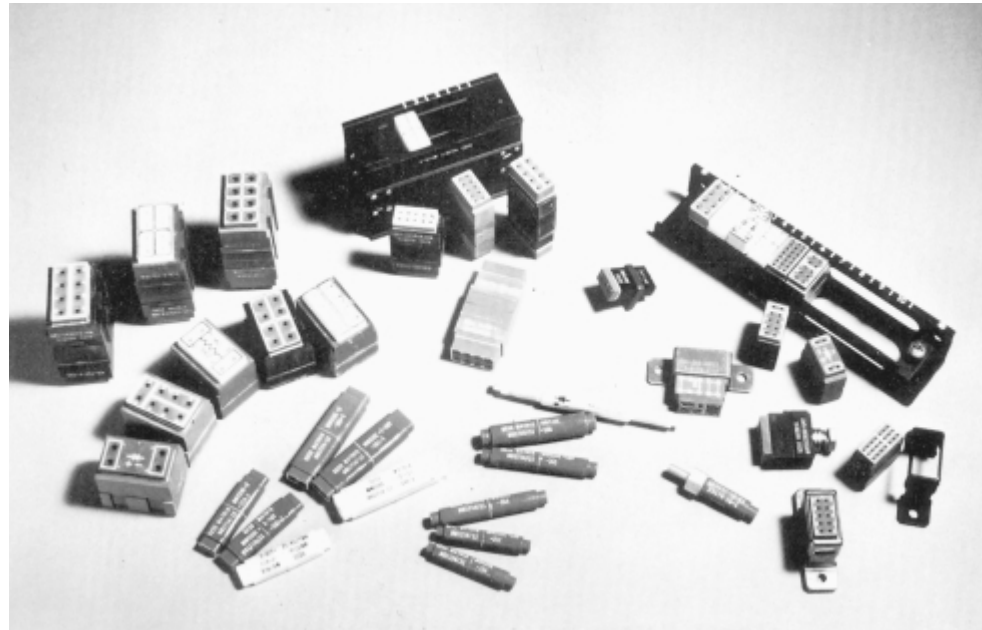

The Terminal Junction System (TJS) provides design engineers with a compact family of modules and splices for interconnecting wires. Both the modules and splices facilitate interconnecting with pre-bussed configurations to which the user's 22 thru 12 AWG wires are terminated with crimped removable pin contacts. Servicing tools required are the commonly available MIL-C-81969/14, plastic tool and MIL-C-22520 crimping tool used

for rear release connector contacts. The TJS eliminates many shortcomings of the conventional lug and threaded termination. The TJS has no loose attaching hardware, such as nuts, screws and lock-washers to complete the termination. The TJS saves space and weight over threaded terminations while reducing installation cost. There is complete electrical isolation and optional environmental

sealing grommet in the TJS without user installed busses, barriers, insulating strips, potting and enclosures. The TJS module pre-bussed integral sockets are permanently connected in a variety of bussing arrangements to suit the most exacting circuit requirements. These modules can be user assembled into any required bussing arrangement and contact size permutation.

Typical Module Construction (Cross-Section)

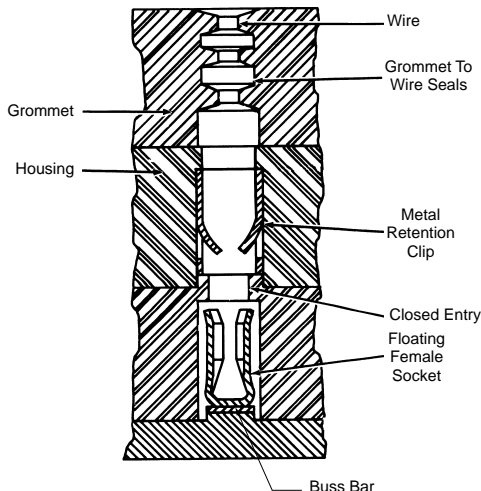

Module With Sealing Plug Installed (Cross-Section)

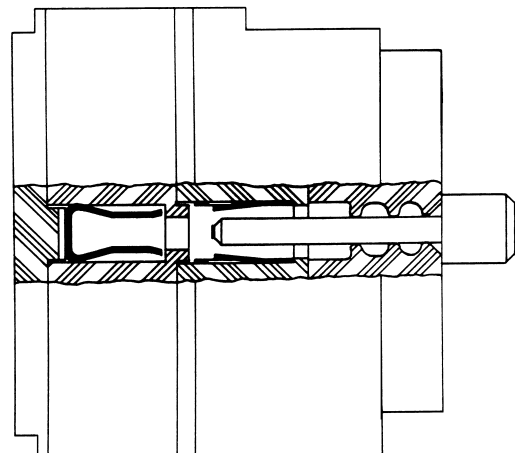

Performance Specifications

Voltage Rating —

Sizes 22, 20, 16, 12

Altitude	DWV*	Working Voltage
Sea level	1,500 V	600 V
70,000 Feet**	600 V	300 V

Size 21 (22HD)

Altitude	DWV*	Working Voltage
Sea Level	1,000 V	600 V
70,000 Feet**	325 V	300 V

* DWV = Dielectric Withstanding Voltage

** [21,336m]

Contact Voltage Drop (Max.) —

Contact Size	Test Current	Initial	After Conditioning
21 (22HD)	5.0 A	55 V	65 V
22	5.0 A	45 V	50 V
20	7.5 A	45 V	50 V
16	13.0 A	50 V	55 V
12	23.0 A	40 V	45 V

The MV drop is measured across an adjacent bussed pair of wire contacts.

Operating Temperature Range —

Class	Minimum	Maximum
D	-65°C (-85°F)	+200°C (+392°F)

Altitude Immersion —

Insulation resistance shall not fall below 5,000 megohms after being subjected to three, 70,000-foot [21,336m] altitude immersion cycles in salt water.

Fluid Immersion —

Class D—Extended fluid type

Fluid	
MIL-H-5606	Hydraulic fluid
MIL-L-23699	Lubricating oil
MIL-T-5624	Aviation fuel
MIL-L-7808	Lubrication oil
MIL-A-8243	Anti-ice fluid
MIL-C-25769	Cleaning fluid
Skydrol	500A & 500B
Aerosafe	2300 & 2300W
Flyjet	III
Esso Oil	Turbo 25

Moisture Resistance —

High Humidity (95% RH) 100 megohms min.
After Drying—24 hours 1,000 megohms min.

Durability —

No performance degradation after 10 cycles of contact insertion/removal.

Vibration —

Class D

Sine, MIL-STD-202, method 204 condition G
Random, MIL-STD-1344, method 2005.

Shock —

Class D

MIL-STD-1344, Method 2004
(300 G, 3 milliseconds duration, half-sine).

Contacts, Sealing Plugs and Assembly Tools

Contacts and Sealing Plugs

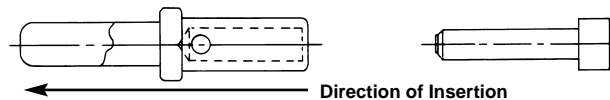

Size	Part Numbers			
	Pin Contacts		Sealing Plugs	
	Commercial	Military	Commercial	Military
21(22HD)	592413-1	M39029/1-507	592104-4	MS27488-22
22	3-592404-1	M39029/1-100	592104-1	MS27488-20
20	2-592404-1	M39029/1-101	592104-1	MS27488-20
16	1-592404-1	M39029/1-102	592104-2	MS27488-16
12	592404-1	M39029/1-103	592104-3	MS27488-12

Insertion/Removal Tools

Size	Part Numbers		Color*	Wire Gage	Contact Wire Dia. Min./Max.	Finished Crimp Tool	Turret or Positioner
	Commercial	Military					
21(22HD)	—	M81969/14-01	Grn/Wh	28-22	.030-.054 [.76-1.37]	M22520/2-01	M22520/2-32
22	592105-1	M81969/14-11	Rd/Wh	26-22	.034-.066 [.86-1.68]	M22520/2-01	M22520/2-11
20	592105-1	M81969/14-11	Rd/Wh	24-20	.038-.083 [.97-2.11]	M22520/1-01 or /2-01	M22520/1-02 or /2-02
16	—	M81969/14-03	Blue/Wh	20-16	.060-.101 [1.52-2.57]	M22520/1-01	M22520/1-02
12	—	M81969/14-04	Yel/Wh	14-12	.087-.147 [2.21-3.73]	M22520/1-01	M22520/1-02

* Colored end for contact insertion; white end for release/removal.

Feedback and Feedthru Terminal Junction Modules

MIL-T-81714 Terminal Junction module blocks are available in sizes 12, 16, 20, 22 and 22HD. The size 12 and 16 feedback blocks have eight cavities each. The size 20 and 22 feedback blocks have 10 cavities each (size 22HD has 21 cavities). The feedthru blocks have the same number of cavities situated on both sides of the block.

Military bussing arrangements are available with each size block.

These module blocks and mounting rail assemblies are qualified to MIL-T-81714. The pin contacts are qualified to MIL-C-39029/1.

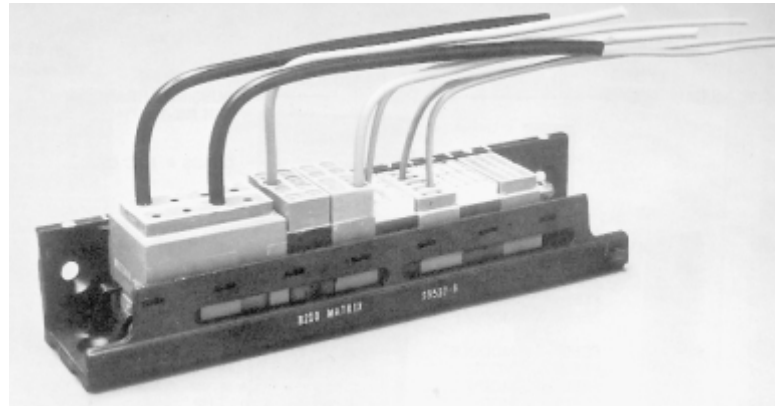

Feedthru

Military Part Numbers Feedthru Modules	AMP Commercial Part Numbers Feedthru Modules
(Class D) Size 20	
M81714/7-DA1	592608-3
M81714/7-DB1	592608-1
M81714/7-DB2	—
M81714/7-DB3	—
M81714/7-DC1	592608-8
M81714/7-DC2	—
M81714/7-DD1	592608-6
M81714/7-DE1	592608-5
M81714/7-DJ1	—
(Class D) Size 16	
M81714/8-DA1	592604-5
M81714/8-DB1	592604-3
M81714/8-DB2	592604-7

Military Part Numbers Feedthru Modules	AMP Commercial Part Numbers Feedthru Modules
(Class D) Size 16 (Continued)	
M81714/8-DC1	592604-9
M81714/8-DC2	—
M81714/8-DD1	592604-1
M81714/8-DH1	—
(Class D) Size 12	
M81714/9-DA1	592600-9
M81714/9-DB1	592600-7
M81714/9-DB2	1-592600-3
M81714/9-DC1	592600-1
M81714/9-DC2	1-592600-1
M81714/9-DD1	592600-5
M81714/9-DH1	592600-3

Notes: Tyco Electronics has not qualified the Feedthru Modules to MIL-T-81714. The Military part number is shown for reference only.

Feedback

Military Part Numbers Feedback Modules	AMP MIL Qualified Part Numbers Feedback Modules	AMP Commercial Part Numbers Feedback Modules
(Class D) Size 22		
M81714/1-DA1	—	592633-4
M81714/1-DB1	—	592633-2
M81714/1-DB2	—	1-592633-2
M81714/1-DB3	—	2-592633-0
M81714/1-DC1	—	1-592633-4
M81714/1-DC2	—	1-592633-0
M81714/1-DD1	—	592633-8
M81714/1-DE1	—	592633-6
(Class D) Size 21		
M81714/17-D31	592629-1	592629-2
M81714/17-D32	592629-3	592629-4
M81714/17-D33	592629-5	592629-6
M81714/17-D34	592629-7	592629-8
M81714/17-D35	592629-9	1-592629-0
M81714/17-D36	4-592629-4	—
M81714/17-D37	1-529629-1	1-592629-2
M81714/17-D38	1-592629-3	1-592629-4
M81714/17-D39	1-592629-5	1-592629-6
M81714/17-D40	1-592629-7	1-592629-8
M81714/17-D42	4-592629-2	4-592629-0
M81714/17-D43	4-592629-3	—
M81714/17-D44	1-592629-9	2-592629-0
M81714/17-D45	4-592629-5	2-592629-2

Military Part Numbers Feedback Modules	AMP MIL Qualified Part Numbers Feedback Modules	AMP Commercial Part Numbers Feedback Modules
(Class D) SIZE 20		
M81714/2-DA1	592624-3	592624-4
M81714/2-DB1	592624-1	592624-2
M81714/2-DB2	1-592624-0	1-592624-1
M81714/2-DB3	1-592624-8	1-592624-9
M81714/2-DC1	1-592624-2	1-592624-3
M81714/2-DC2	2-592624-2	592624-9
M81714/2-DD1	592624-7	592624-8
M81714/2-DE1	592624-5	592624-6
(Class D) SIZE 16		
M81714/3-DA1	592620-5	592620-6
M81714/3-DB1	592620-3	592620-4
M81714/3-DB2	592620-9	1-592620-0
M81714/3-DC1	1-592620-1	1-592620-2
M81714/3-DC2	592620-7	592620-8
M81714/3-DD1	592620-1	592620-2
(Class D) SIZE 12		
M81714/4-DA1	—	592616-6
M81714/4-DB1	—	592616-4
M81714/4-DB2	—	1-592616-0
M81714/4-DC1	—	1-592616-2
M81714/4-DC2	—	592616-8
M81714/4-DD1	—	592616-1

Typical Bussing Arrangements

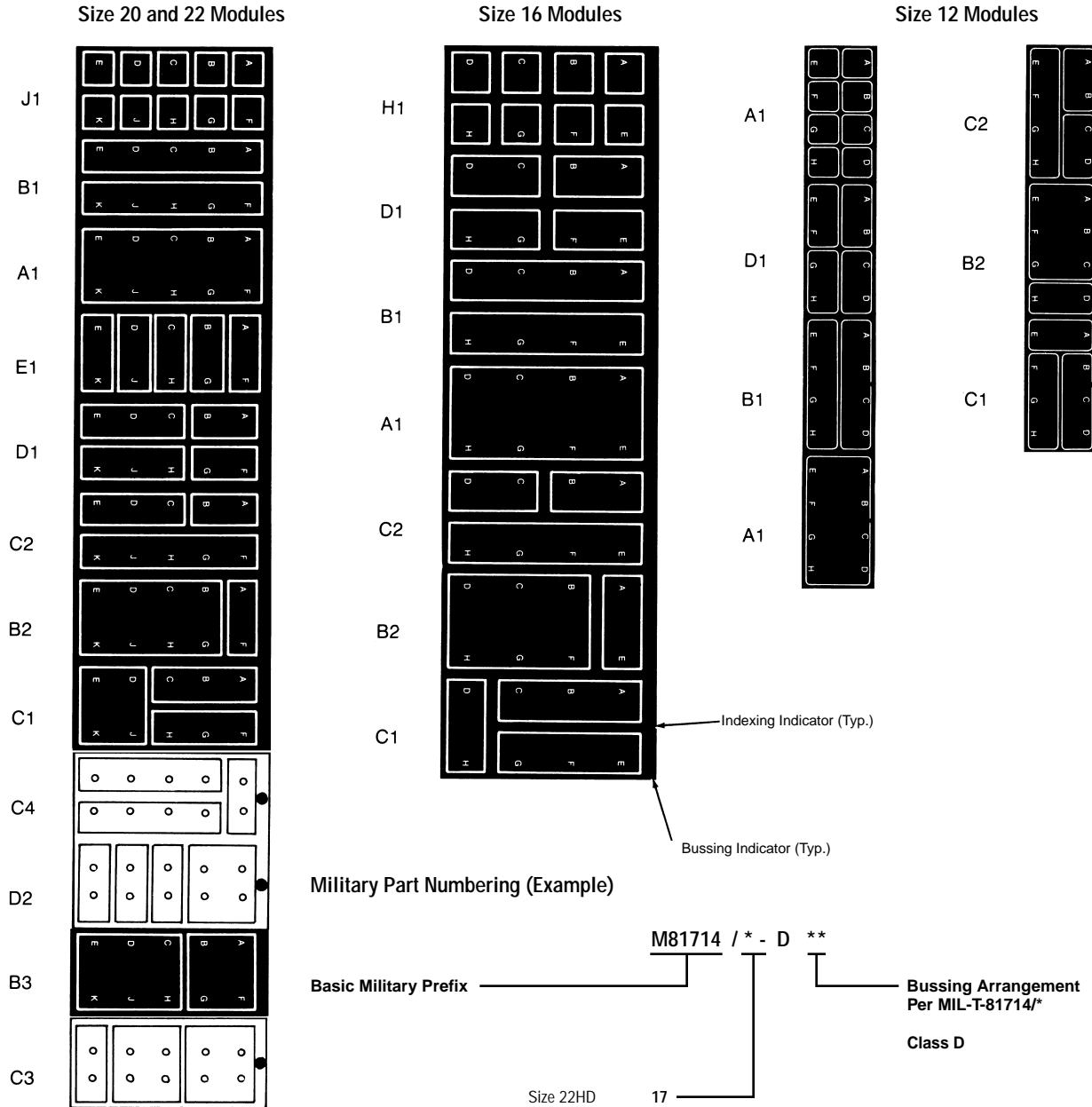

Consult Tyco Electronics for additional bussing arrangements.

Military Part Numbering (Example)

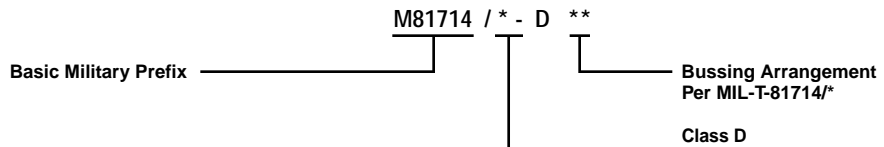

	Size 22HD	17
	Size 22	1
Feedback Module	Size 20	2
	Size 16	3
	Size 12	4
	Size 22	6
Feedthru Module*	Size 20	7
	Size 16	8
	Size 12	9

* For Reference Only

- Notes:** 1. When ordered to military part number, contacts and sealing plugs are included.
 2. Mounting hardware is not included; order separately. (See pages 5202 and 5203.)
 3. Size 16 Module Dim. (Typ.) — (Feedback) .850 [21.59] L x .390 [9.91] W x 1.000 [25.40] H
 (Feedthru) .850 [21.59] L x .390 [9.91] W x 1.830 [46.48] H

Typical Bussing Arrangements

Size 22HD Military,
Size 21 Commercial
Modules

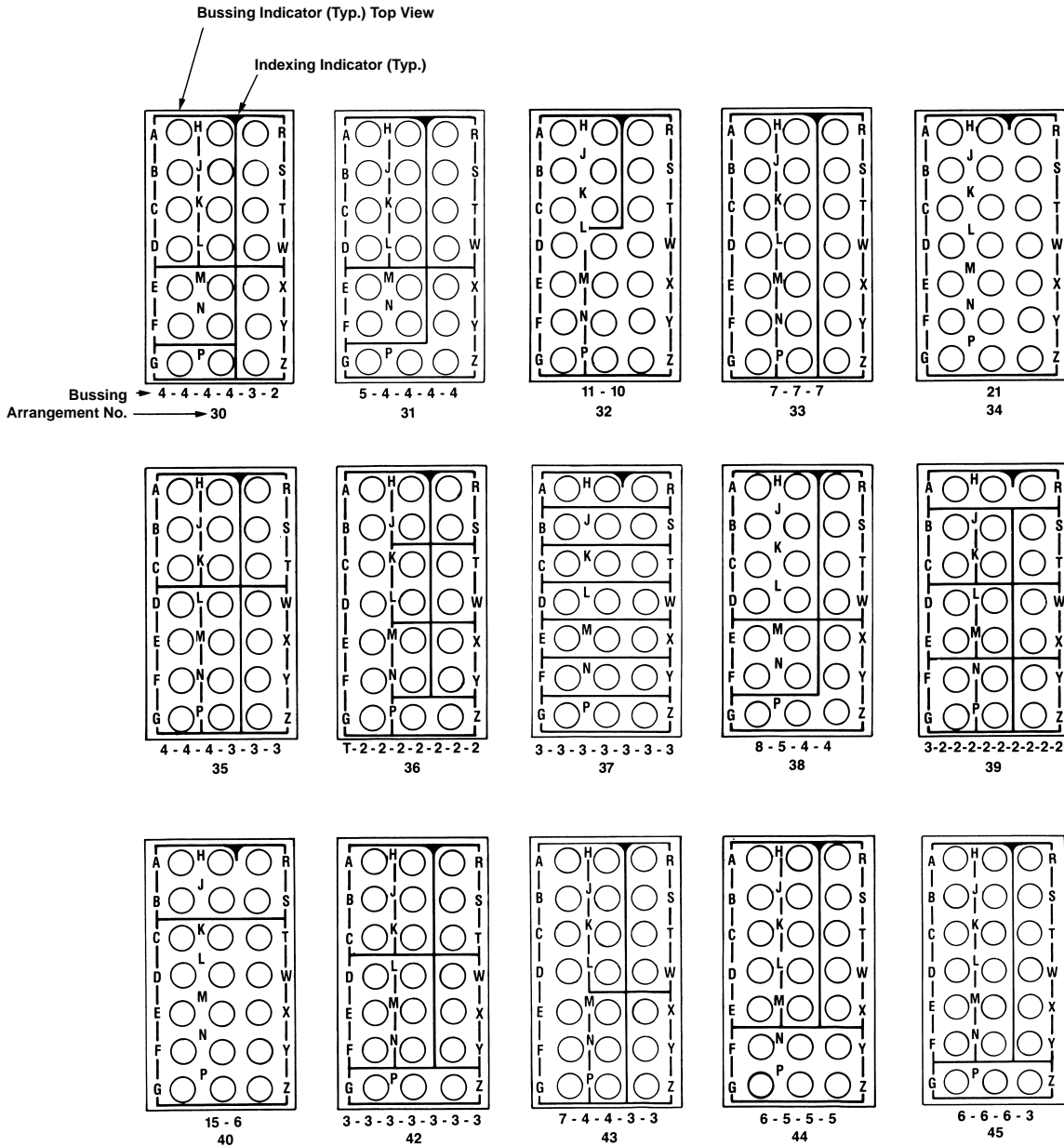

Feedback Terminal Junction Modules (Continued)

Mounting Hardware
Standard Weight
Rail Assembly
Part Number 591613

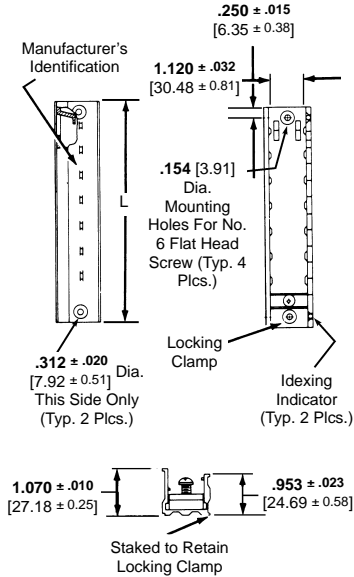

Rail Assembly Dimensions

Length L	591613 and 591621 Part Numbers			
	Standard Weight		Lightweight	
	591613	M81714/5	591621	M81714/16
1.781 [45.24]	-1	—	-1	—
2.171 [55.14]	-2	—	-2	—
2.561 [65.05]	-3	-2	-3	-2
2.951 [74.96]	-4	-3	-4	-3
3.341 [84.86]	-5	-4	-5	-4
3.371 [85.62]	-6	-5	-6	-5
4.121 [104.67]	-7	-6	-7	-6
4.511 [114.58]	-8	-7	-8	-7
4.901 [124.49]	-9	-8	-9	-8
5.291 [134.39]	-10	-1	-10	-1
5.681 [144.30]	-11	-9	-11	-9
6.071 [154.20]	-12	-10	-12	-10
6.461 [164.11]	-13	-11	-13	-11
6.851 [174.02]	-14	-12	-14	-12
7.241 [183.92]	-15	-13	-15	-13
7.631 [193.83]	-16	—	-16	—
8.021 [203.73]	-17	—	-17	—
8.411 [213.64]	-18	—	-18	—
8.801 [223.54]	-19	—	-19	—
9.191 [233.45]	-20	—	-20	—

Lightweight Rail Assembly
Part Number 591621 (weight savings of up to 40%)

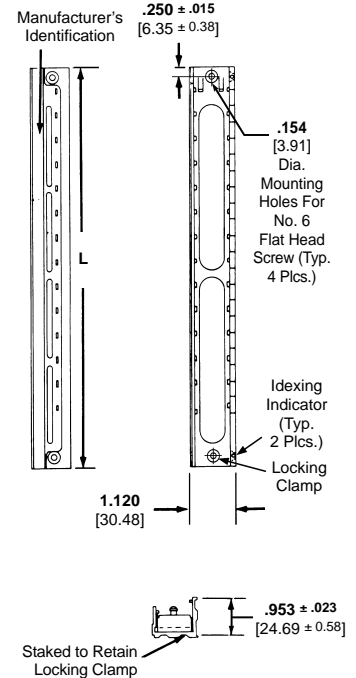

Rail Assemblies are made of black anodized aluminum alloy. Locking clamp screw is corrosion resistant steel (passivated). Rails will accommodate all sizes and various quantities of feedback modules in any combination.

Rail Part Numbering

Military

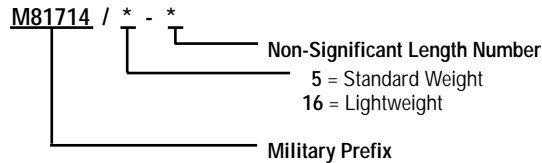

Note: Rail Assemblies do not contain module blocks. Order separately. (See page 5199.)

†(based on Size 22, 20, and 16 dimensions)

Individual Module Mounting
Brackets

Part Number 591637-1

(Commercial equiv. to Military M81714/29-1)
Accommodates one Size 21, 22, 20 or 16 module.

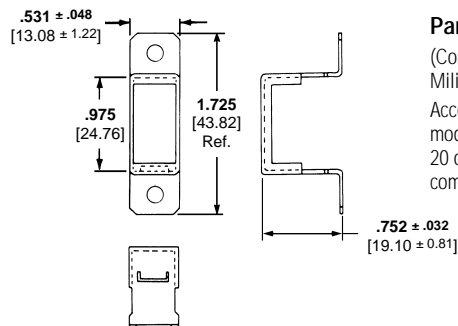

Part Number 591638-1

(Commercial equiv. to Military M81714/29-2)
Accommodates one Size 12 module or three Size 21, 22, 20 or 16 modules in any combination.

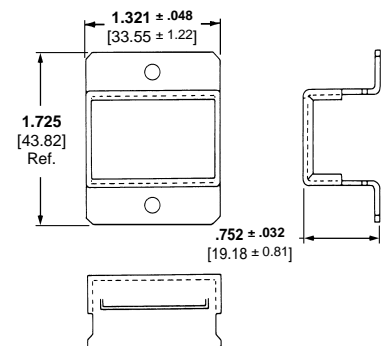

Mounting Hardware

Standard Weight
Rail Assembly
Part Number 591601

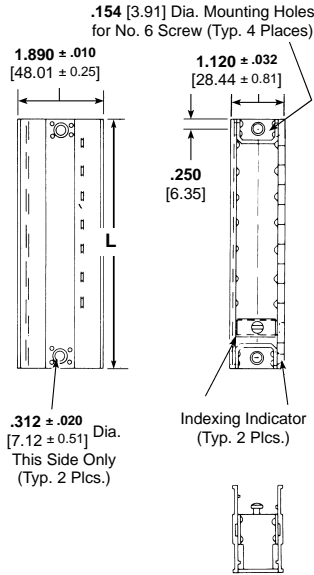

Lightweight Rail Assembly
Part Number 591603

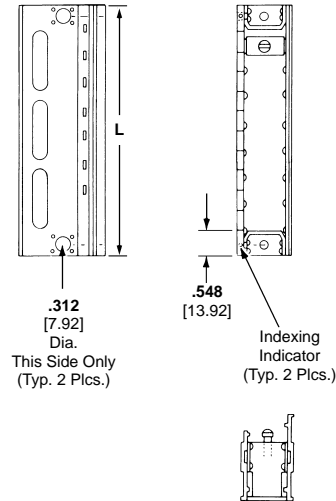

Rail Assembly Dimensions

Length L	591601 and 591603 Part Numbers	
	Standard Weight	Lightweight
	Commercial*	Commercial**
	591601	591603
2.041 [51.84]	-1	—
2.431 [61.75]	-2	—
2.821 [71.65]	-3	—
3.211 [81.56]	-4	—
3.601 [91.46]	-5	-4
3.991 [101.37]	-6	-5
4.381 [111.28]	-7	—
4.771 [121.18]	-8	—
5.161 [131.09]	-9	—
5.551 [141.00]	-10	—
5.941 [150.90]	-11	-1
6.331 [160.81]	-12	—
6.721 [170.71]	-13	—
7.111 [180.62]	-14	-2
7.501 [190.52]	-15	-3
7.891 [200.43]	-16	—
8.281 [210.34]	-17	—
8.671 [220.24]	-18	—
9.061 [230.15]	-19	—
9.451 [240.06]	-20	—

Rail Assemblies are made of black anodized aluminum alloy. Locking clamp screw is corrosion resistant steel (passivated). Rails will accommodate all sizes and various quantities of feed thru modules in any combination.

* Commercial equivalent to M81714/10-*

** Commercial equivalent to M81714/14-*

Feedback

Grounding Flange Modules

AMP Grounding Flange Blocks are available in Sizes 22, 20, 16 and 12. All contacts are bussed together and connected to a ground plate made of nickel plated aluminum.

HD22
Part Number 592840

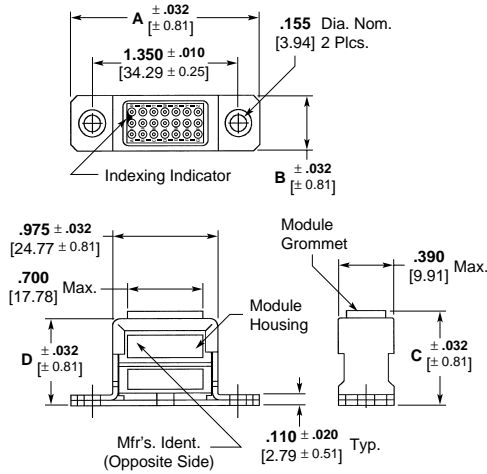

Size 20, 22
Part Number 592836

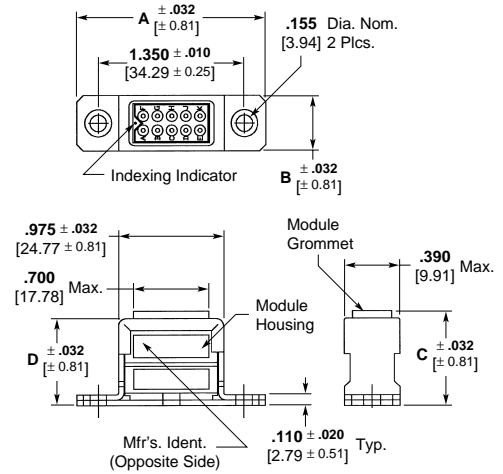

Size 12
Part Number 592820-1

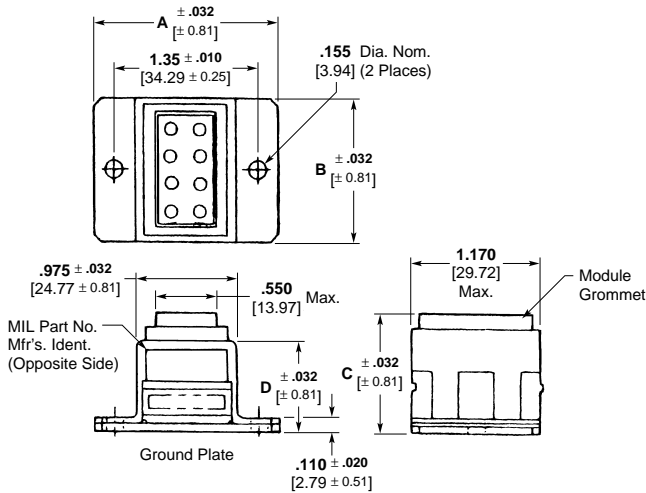

Size 16
Part Number 592830-1

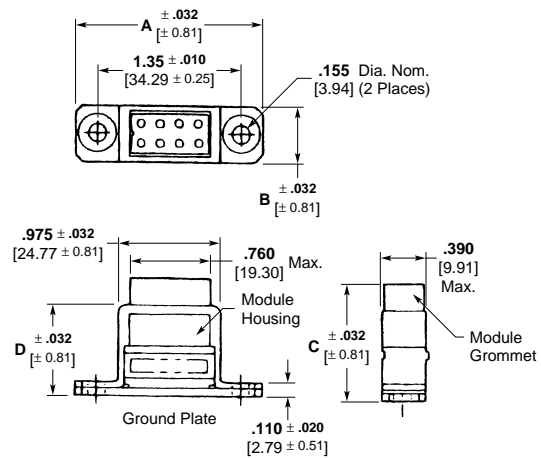

Commercial Equivalent to Military M81714/28-* **

Contact Size	Dimensions				Part No.
	A	B	C	D	
HD22	1.725	0.515	0.880	0.817	592840-2
	43.82	13.08	22.35	20.75	
22	1.725	0.515	0.880	0.817	592836-3
	43.82	13.08	22.35	20.75	
20	1.725	0.515	0.880	0.817	592836-1
	43.82	13.08	22.35	20.75	
16	1.725	0.515	1.060	0.817	592830-1
	43.82	13.08	26.92	20.75	
12	1.725	1.305	1.060	0.817	592820-1
	43.82	33.15	26.92	20.75	

Wire Splices

Single Splice

Built and qualified to MIL-T-81714, the commercial Single Wire Splice provides an environmentally reliable, positive and maintainable in-line disconnect between single wires. Their small diameter permits placement within a wire bundle or electrical harness. The standard M39029/1 pin contact is utilized. Single wire splices are available per MIL-T-81714.

Double Splice

Provides an environmental in-line disconnect for joining up to four wires. Bussed or unbussed contacts are available permitting the versatility of joining wires in double, triple or quadruple combinations.

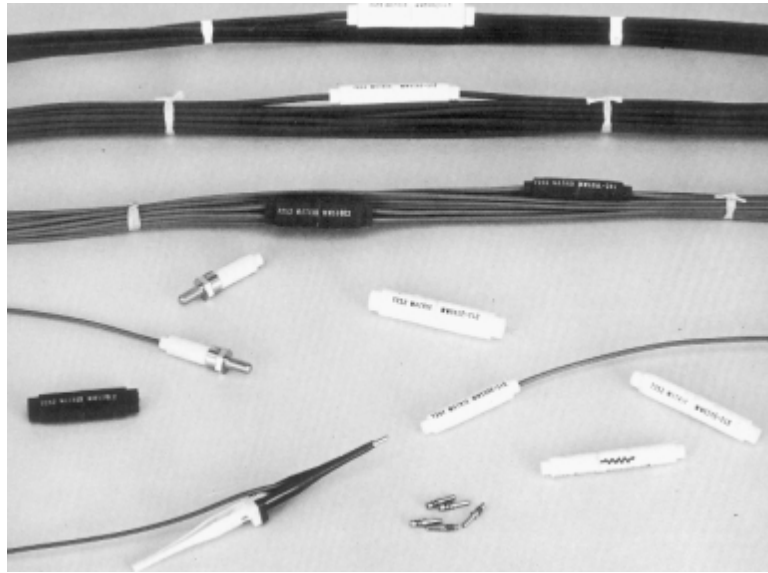

Part Numbering

Military

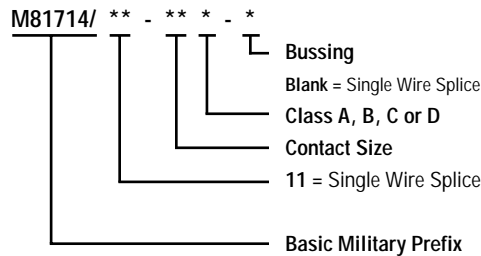

Double Spliced

Contact Size	Bussed Part No.	Unbussed Part No.
22	592588-6	—
20	592588-5	592589-1
16	592588-4	—

Single Splice

Contact Size	Part No.	MIL Part No. M81714/11
20	592583-3	-20D
16	592583-2	-16D
12	592583-1	-12D

Electronics

Electronic Module Blocks and Splices

Electronic Modules, Splices and Mounting Hardware are custom engineered to suit the user's application. During design, specific part numbers will be assigned. (see page 5210.)

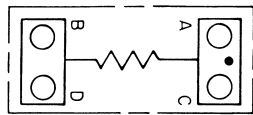
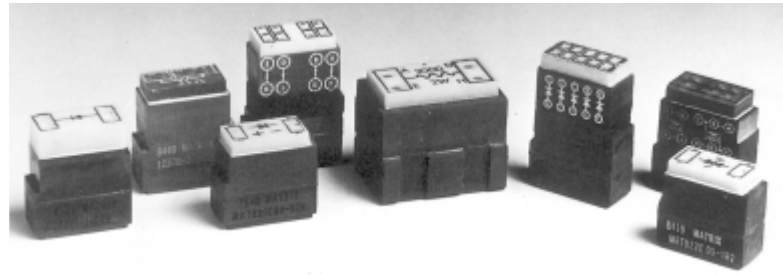

TOP MARKING (TYP)

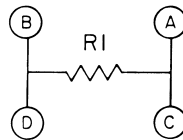

SCHEMATIC DIAGRAM

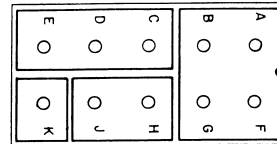

TOP MARKING

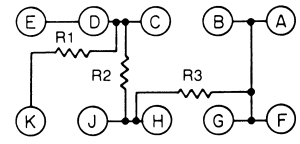

SCHEMATIC DIAGRAM

Fig. 1A

Fig. 5A

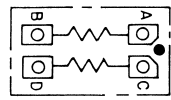

TOP MARKING (TYP)

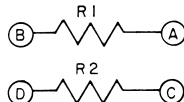

SCHEMATIC DIAGRAM

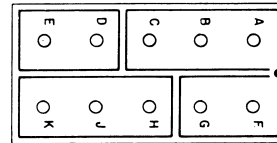

TOP MARKING

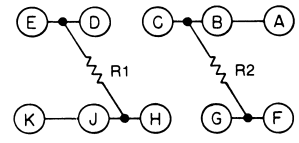

SCHEMATIC DIAGRAM

Fig. 2A

Fig. 6A

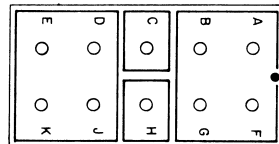

TOP MARKING

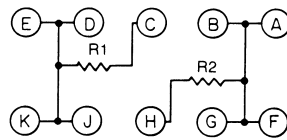

SCHEMATIC DIAGRAM

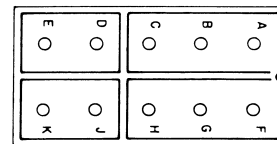

TOP MARKING

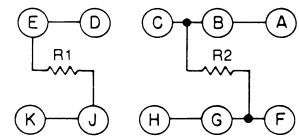

SCHEMATIC DIAGRAM

Fig. 3A

Fig. 7A

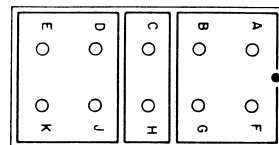

TOP MARKING

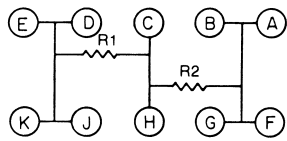

SCHEMATIC DIAGRAM

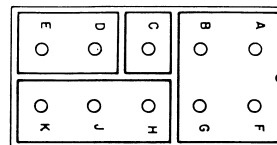

TOP MARKING

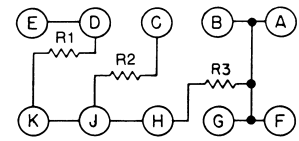

SCHEMATIC DIAGRAM

Fig. 4A

Fig. 8A

Consult Tyco Electronics for additional circuit arrangements.

Typical Diode Circuit Arrangements

(See page 5210 for Part Numbers.)

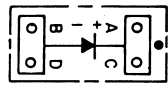

TOP MARKING

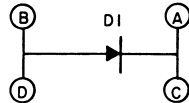

SCHEMATIC DIAGRAM

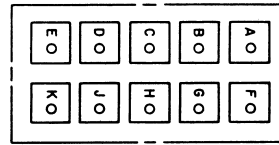

TOP MARKING (TYP)

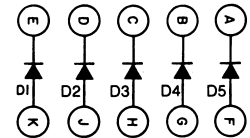

SCHEMATIC DIAGRAM

Fig. 1B

Fig. 5B

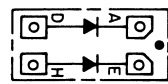

TOP MARKING

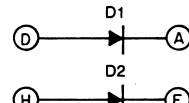

SCHEMATIC DIAGRAM

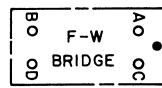

TOP MARKING

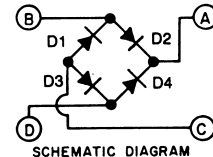

SCHEMATIC DIAGRAM

Fig. 2B

Fig. 6B

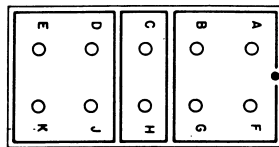

TOP MARKING

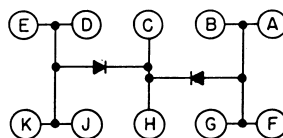

SCHEMATIC DIAGRAM

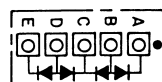

TOP MARKING (TYP)

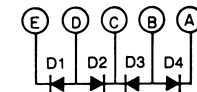

SCHEMATIC DIAGRAM

Fig. 3B

Fig. 7B

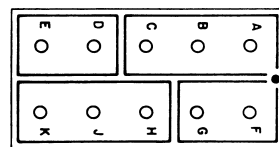

TOP MARKING

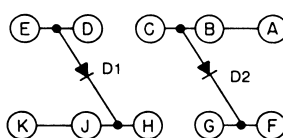

SCHEMATIC DIAGRAM

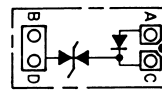

TOP MARKING (TYP)

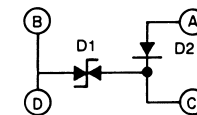

SCHEMATIC DIAGRAM

Fig. 4B

Fig. 8B

Consult Tyco Electronics for additional circuit arrangements.

Typical Combination
Circuit Arrangements

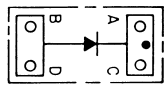

TOP MARKING

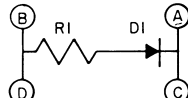

SCHEMATIC DIAGRAM

Fig. 1C

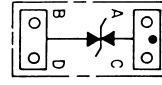

TOP MARKING

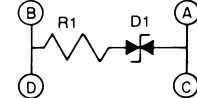

SCHEMATIC DIAGRAM

Fig. 5C

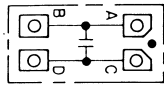

TOP MARKING (TYP)

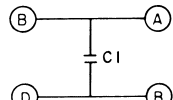

SCHEMATIC DIAGRAM

Fig. 2C

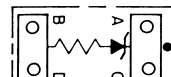

TOP MARKING (TYP)

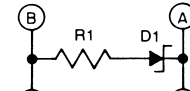

SCHEMATIC DIAGRAM

Fig. 6C

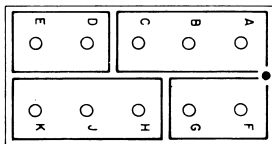

TOP MARKING

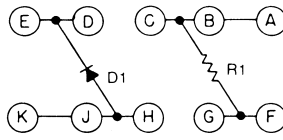

SCHEMATIC DIAGRAM

Fig. 3C

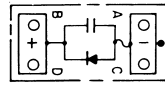

TOP MARKING

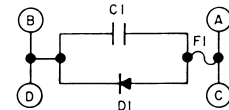

SCHEMATIC DIAGRAM

Fig. 7C

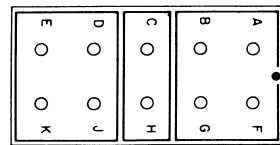

TOP MARKING

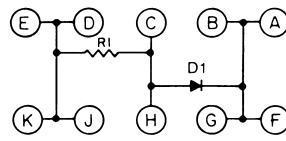

SCHEMATIC DIAGRAM

Fig. 4C

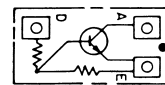

TOP MARKING

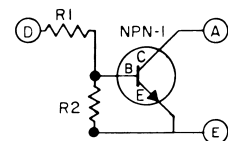

SCHEMATIC DIAGRAM

Fig. 8C

Consult Tyco Electronics for additional circuit arrangements.

Various Component Types

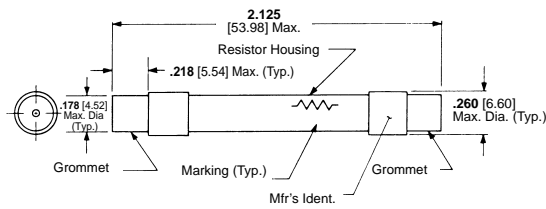

Fig. 1D

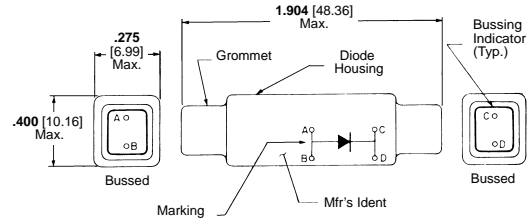

Fig. 5D

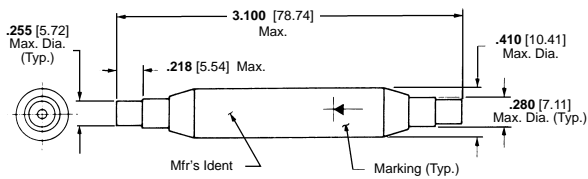

Fig. 2D

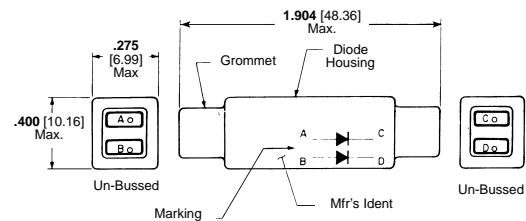

Fig. 6D

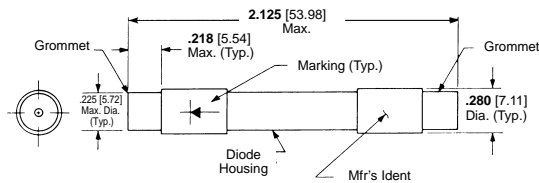

Fig. 3D

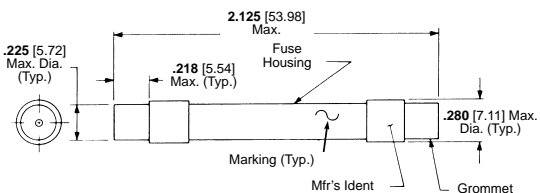

Fig. 7D

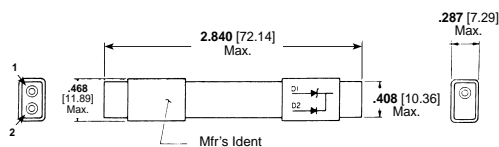

Fig. 4D

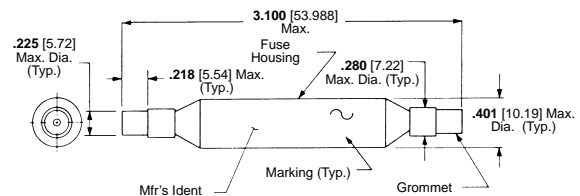

Fig. 8D

5 Pin and Socket Connectors

Electronic Module Blocks and Splices Part Numbering Information

Description	Figure	Part Number	Electrical Information
Module Blocks	Fig. 1A	591872-1	R1=1500 Ω RCR07G152JS
		591873-1	R1=9100 Ω RLR07C9101GS
		591877-2	R1=150 Ω
		591899-1	R=RLR20C10R0GS 10 Ω
	Fig. 2A	591892-1	R1=R2=127 Ω RNC55H1270FS
		591898-1	R1=R2=10 Ω RLR20C10R0GS
		591876-1	R1=180 Ω RLR07C1800GS R2=487 Ω RLR07C4870FS
		591871-1	R1=R2=2200 Ω RCR07G222JS
		591875-1	R1=180 Ω RLR07C1800GS R2=348 Ω RLR07C3480FS
		Fig. 4A	591911-1
	Fig. 5B	591854-1	D1=D2=D3=D4=D5=JAN1N5618
		591855-1	D1=D2=D3=D4=D5=JANTX1N5618
	Fig. 7B	591857-2	D1=D2=D3=D4=D5=JANTX1N5618
		592887-1	D1=D2=D3=D4=1N4007
Module Blocks (Diode Circuits)	Fig. 1B	591893-2	D1=JANTX1N5624
		591894-2	D1=JANTX1N751A
		591896-2	D1=JANTX1N5552
		591893-2	D1=JANTX1N5624
		591894-2	D1=JANTX1N751A
	Fig. 5B	591895-2	D1=JANTX1N5618
		591864-1	D1=JAN1N5618
		591866-1	D1=D2=D3=D4=D5=JANTX1N5554
		591863-1	D1=D2=D3=D4=D5=JANTX1N5552
		591863-4	D1=D2=D3=D4=D5=1N4007
Splices	Fig. 2D	591865-1	D1=D2=D3=D4=D5=JANTX1N5618 Class A
		591855-1	D1=D2=D3=D4=D5=JANTX1N5618
		591917-1	R1=RN65C1270F 127 Ω
		591917-3	R1=RNC60J1002FS 10 Ω
		591917-4	R1=RC20GF681J 680 Ω
		591917-5	R1=RLR32C1201GM 1200 Ω
		591917-7	R1=RLR32C1000GS 100 Ω
	Fig. 3D	1-591917-2	R1=RLR07C1001GR 1000 Ω
		1-591917-3	R1=RLR32C1000GR 100 Ω
		591846-2	D1=1N5199
Fig. 4D	591847-3	D1=JAN1N5618	
Fig. 5D	591992-1	D1=JANTX1N4972 D2=JANTX1N5618	
	591841-1	D1=JAN1N5618	
Fig. 6D	591889-1	D1=1N3981	
	591890-1	D1=1N5367B	
		591842-1	D1=D2=JAN1N5618

Military Cross Reference

Note: Products are also qualified to VG 95212-31/ VG 95231-102/103/105. Please contact Tyco Electronics for cross reference.

Military Part Numbers Feedback Modules	AMP MIL Qualified Part Numbers Feedback Modules	AMP Commercial Part Numbers Feedback Modules
(Class A) Size 22		
M81714/1-AA1	—	592634-4
M81714/1-AB1	—	592634-2
M81714/1-AB2	—	1-592634-2
M81714/1-AB3	—	1-592634-7
M81714/1-AC1	—	1-592634-4
M81714/1-AC2	—	1-592634-0
M81714/1-AD1	—	592634-8
M81714/1-AE1	—	592634-6
(Class A) Size 21		
M81714/17-A31	592630-3	592630-4
M81714/17-A32	592630-5	592630-6
M81714/17-A33	592630-7	592630-8
M81714/17-A34	592630-9	1-592630-0
M81714/17-A35	1-592630-1	1-592630-2
M81714/17-A36	1-592630-3	1-592630-4
M81714/17-A37	1-592630-5	1-592630-6
M81714/17-A38	1-592630-7	1-592630-8
M81714/17-A39	1-592630-9	2-592630-0
M81714/17-A40	2-592630-1	2-592630-2
M81714/17-A42	2-592630-3	2-592630-4
M81714/17-A43	4-592630-3	4-592630-4
M81714/17-A44	2-592630-5	2-592630-6
M81714/17-A45	2-592630-7	2-592630-8
(Class A) Size 20		
M81714/2-AA1	592625-5	592625-6
M81714/2-AB1	592625-3	592625-4
M81714/2-AB2	1-592625-3	1-592625-4
M81714/2-AB3	2-592625-1	2-592625-2
M81714/2-AC1	1-592625-5	1-592625-6
M81714/2-AC2	1-592625-1	1-592625-2
M81714/2-AD1	592625-9	1-592625-0
M81714/2-AE1	592625-7	592625-8
(Class A) Size 16		
M81714/3-AA1	592621-7	592621-8
M81714/3-AB1	592621-5	592621-6
M81714/3-AB2	1-592621-1	1-592621-2
M81714/3-AC1	1-592621-3	1-592621-4
M81714/3-AC2	592621-9	1-592621-0
M81714/3-AD1	592621-3	592621-4
(Class A) Size 12		
M81714/4-AA1	—	592617-8
M81714/4-AB1	—	592617-6
M81714/4-AB2	—	1-592617-2
M81714/4-AC1	—	1-592617-4
M81714/4-AC2	—	1-592617-0
M81714/4-AD1	—	592617-4
(Class B) Size 22		
M81714/1-BA1	—	592636-4
M81714/1-BB1	—	592636-2
M81714/1-BB2	—	1-592636-2
M81714/1-BB3	—	1-592636-6
M81714/1-BC1	—	1-592636-4
M81714/1-BC2	—	1-592636-0
M81714/1-BD1	—	592636-8
M81714/1-BE1	—	592636-6
(Class B) Size 21		
M81714/17-B31	592631-3	592631-4
M81714/17-B32	592631-5	592631-6
M81714/17-B33	592631-7	592631-8

Feedback Modules (Class B) Size 21 Continued on page 5212

Military Cross Reference (Continued)

Military Part Numbers Feedback Modules	AMP MIL Qualified Part Numbers Feedback Modules	AMP Commercial Part Numbers Feedback Modules
(Class B) Size 21 (Continued)		
M81714/17-B34	592631-9	1-592631-0
M81714/17-B35	1-592631-1	1-592631-2
M81714/17-B36	1-592631-3	1-592631-4
M81714/17-B37	1-592631-5	1-592631-6
M81714/17-B38	4-592631-4	—
M81714/17-B39	1-592631-7	1-592631-8
M81714/17-B40	4-592631-2	—
M81714/17-B42	1-592631-9	2-592631-0
M81714/17-B43	2-592631-1	2-592631-2
M81714/17-B44	2-592631-4	2-592631-5
M81714/17-B45	4-592631-3	—
(Class B) Size 20		
M81714/2-BA1	592627-3	592627-4
M81714/2-BB1	592627-1	592627-2
M81714/2-BB2	1-592627-1	1-592627-2
M81714/2-BB3	1-592627-5	1-592627-6
M81714/2-BC1	1-592627-3	1-592627-4
M81714/2-BC2	592627-9	1-592627-0
M81714/2-BD1	592627-7	592627-8
M81714/2-BE1	592627-5	592627-6
(Class B) Size 16		
M81714/3-BA1	592623-5	592623-6
M81714/3-BB1	592623-3	592623-4
M81714/3-BB2	592623-9	1-592623-0
M81714/3-BC1	1-592623-1	1-592623-2
M81714/3-BC2	592623-7	592623-8
M81714/3-BD1	592623-1	592623-2
(Class B) Size 12		
M81714/4-BA1	—	592619-6
M81714/4-BB1	—	592619-4
M81714/4-BB2	—	1-592619-0
M81714/4-BC1	—	1-592619-2
M81714/4-BC2	—	592619-8
M81714/4-BD1	—	592619-2
(Class C) Size 22		
M81714/1-CA1	—	592635-4
M81714/1-CB1	—	592635-2
M81714/1-CB2	—	1-592635-2
M81714/1-CB3	—	1-592635-6
M81714/1-CC1	—	1-592635-4
M81714/1-CC2	—	1-592635-0
M81714/1-CD1	—	592635-8
M81714/1-CE1	—	592635-6
(Class C) Size 21		
M81714/17-C31	592632-1	592632-2
M81714/17-C32	4-592632-3	—
M81714/17-C33	592632-3	592632-4
M81714/17-C34	592632-5	—
M81714/17-C35	592632-6	592632-7
M81714/17-C36	592632-8	592632-9
M81714/17-C37	1-592632-1	1-592632-2
M81714/17-C38	1-592632-3	—
M81714/17-C39	4-592632-4	—
M81714/17-C40	1-592632-4	1-592632-5
M81714/17-C41	4-592632-1	—
M81714/17-C42	4-592632-5	—
M81714/17-C43	1-592632-6	1-592632-7
M81714/17-C44	1-592632-8	1-592632-9
M81714/17-C45	4-592632-6	—

Military Cross Reference (Continued)

Military Part Numbers Feedback Modules	AMP MIL Qualified Part Numbers Feedback Modules	AMP Commercial Part Numbers Feedback Modules
(Class C) Size 20		
M81714/2-CA1	592626-3	592626-4
M81714/2-CB1	592626-1	592626-2
M81714/2-CB2	1-592626-1	1-592626-2
M81714/2-CB3	2-592626-4	1-592626-5
M81714/2-CC1	1-592626-3	1-592626-4
M81714/2-CC2	592626-9	1-592626-0
M81714/2-CD1	592626-7	592626-8
M81714/2-CE1	592626-5	592626-6
(Class C) Size 16		
M81714/3-CA1	592622-5	592622-6
M81714/3-CB1	592622-3	592622-4
M81714/3-CB2	592622-9	1-592622-0
M81714/3-CC1	1-592622-1	1-592622-2
M81714/3-CC2	592622-7	592622-8
M81714/3-CD1	592622-1	592622-2
(Class C) Size 12		
M81714/4-CA1	—	592618-6
M81714/4-CB1	—	592618-4
M81714/4-CB2	—	1-592618-0
M81714/4-CC1	—	1-592618-2
M81714/4-CC2	—	592618-8
M81714/4-CD1	—	592618-2
(Class D) Size 22		
M81714/1-DA1	—	592633-4
M81714/1-DB1	—	592633-2
M81714/1-DB2	—	1-592633-2
M81714/1-DB3	—	2-592633-0
M81714/1-DC1	—	1-592633-4
M81714/1-DC2	—	1-592633-0
M81714/1-DD1	—	592633-8
M81714/1-DE1	—	592633-6
(Class D) Size 21		
M81714/17-D31	592629-1	592629-2
M81714/17-D32	592629-3	592629-4
M81714/17-D33	592629-5	592629-6
M81714/17-D34	592629-7	592629-8
M81714/17-D35	592629-9	1-592629-0
M81714/17-D36	4-592629-4	—
M81714/17-D37	1-592629-1	1-592629-2
M81714/17-D38	1-592629-3	1-592629-4
M81714/17-D39	1-592629-5	1-592629-6
M81714/17-D40	1-592629-7	1-592629-8
M81714/17-D42	4-592629-2	4-592629-0
M81714/17-D43	4-592629-3	—
M81714/17-D44	1-592629-9	2-592629-0
M81714/17-D45	4-592629-5	2-592629-2
(Class D) Size 20		
M81714/2-DA1	592624-3	592624-4
M81714/2-DB1	592624-1	592624-2
M81714/2-DB2	1-592624-0	1-592624-1
M81714/2-DB3	1-592624-8	1-592624-9
M81714/2-DC1	1-592624-2	1-592624-3
M81714/2-DC2	2-592624-2	592624-9
M81714/2-DD1	592624-7	592624-8
M81714/2-DE1	592624-5	592624-6

Military Cross Reference (Continued)

Military Part Numbers Feedback Modules	AMP MIL Qualified Part Numbers Feedback Modules	AMP Commercial Part Numbers Feedback Modules
(Class D) Size 16		
M81714/3-DA1	592620-5	592620-6
M81714/3-DB1	592620-3	592620-4
M81714/3-DB2	592620-9	1-592620-0
M81714/3-DC1	1-592620-1	1-592620-2
M81714/3-DC2	592620-7	592620-8
M81714/3-DD1	592620-1	592620-2
M81714/4-DA1	—	592616-6
M81714/4-DB1	—	592616-4
M81714/4-DB2	—	1-592616-0
M81714/4-DC1	—	1-592616-2
M81714/4-DC2	—	592616-8
M81714/4-DD1	—	592616-1

Military Part Numbers Wire Splice	AMP MIL Qualified Part Numbers Wire Splice	AMP Commercial Part Numbers Wire Splice
(Class A) Size 22		
M81714/11-22A	—	1-592575-9
(Class A) Size 20		
M81714/11-20A	592575-7	1-592575-8
(Class A) Size 16		
M81714/11-16A	592575-4	1-592575-4
(Class A) Size 12		
M81714/11-12A	592575-1	1-592575-3
(Class B) Size 22		
M81714/11-22B	—	1-592575-6
(Class B) Size 20		
M81714/11-20B	592575-9	2-592575-2
(Class B) Size 16		
M81714/11-16B	592575-6	2-592575-0
(Class B) Size 12		
M81714/11-12B	592575-3	—
(Class C) Size 22		
M81714/11-22C	—	1-592575-5
(Class C) Size 20		
M81714/11-20C	592575-8	2-592575-1
(Class C) Size 16		
M81714/11-16C	592575-5	1-592575-9
(Class C) Size 12		
M81714/11-12C	592575-2	—
(Class D) Size 22		
M81714/11-22D	—	592583-7
(Class D) Size 20		
M81714/11-20D	592583-3	592583-6
(Class D) Size 16		
M81714/11-16D	592583-2	592583-5
(Class D) Size 12		
M81714/11-12D	592583-1	—

Military Cross Reference (Continued)

Military Part Numbers Lightweight Feedback Rail Assembly	AMP MIL Qualified Part Numbers Lightweight Feedback Rail Assembly	AMP Commercial Part Numbers Lightweight Feedback Rail Assembly
M81714/16-1	1-591621-0	—
M81714/16-2	591621-3	—
M81714/16-3	591621-4	—
M81714/16-4	591621-5	—
M81714/16-5	591621-6	—
M81714/16-6	591621-7	—
M81714/16-7	591621-8	—
M81714/16-8	591621-9	—
M81714/16-9	1-591621-1	—
M81714/16-10	1-591621-2	—
M81714/16-11	1-591621-3	—
M81714/16-12	1-591621-4	—

Military Part Numbers Feedback Rail Assembly	AMP MIL Qualified Part Numbers Feedback Rail Assembly	AMP Commercial Part Numbers Feedback Rail Assembly
M81714/5-1	1-591613-0	—
M81714/5-2	591613-3	—
M81714/5-3	591613-4	—
M81714/5-4	591613-5	—
M81714/5-5	591613-6	—
M81714/5-6	591613-7	—
M81714/5-7	591613-8	—
M81714/5-8	591613-9	—
M81714/5-9	1-591613-1	—
M81714/5-10	1-591613-2	—
M81714/5-11	1-591613-3	—
M81714/5-12	1-591613-4	—
M81714/5-13	1-591613-5	—

Military Part Numbers Feedthru Modules	AMP MIL Qualified Part Numbers Feedthru Modules	AMP Commercial Part Numbers Feedthru Modules
(Class A) Size 22		
M81714/6-AA1	—	592613-6
M81714/6-AB1	—	592613-4
M81714/6-AB2	—	1-592613-6
M81714/6-AB3	—	2-592613-0
M81714/6-AC1	—	1-592613-8
M81714/6-AC2	—	1-592613-4
M81714/6-AD1	—	1-592613-2
M81714/6-AE1	—	592613-8
M81714/6-AJ1	—	592613-2
(Class A) Size 20		
M81714/7-AA1	—	592609-6
M81714/7-AB1	—	592609-4
M81714/7-AB2	—	1-592609-4
M81714/7-AB3	—	1-592609-8
M81714/7-AC1	—	1-592609-6
M81714/7-AC2	—	1-592609-2
M81714/7-AD1	—	1-592609-0
M81714/7-AE1	—	592609-8
M81714/7-AJ1	—	592609-2

Military Cross Reference (Continued)

Military Part Numbers Feedthru Modules	AMP MIL Qualified Part Numbers Feedthru Modules	AMP Commercial Part Numbers Feedthru Modules
(Class A) Size 16		
M81714/8-AA1	—	592605-8
M81714/8-AB1	—	592605-6
M81714/8-AB2	—	1-592605-2
M81714/8-AC1	—	1-592605-4
M81714/8-AC2	—	1-592605-0
M81714/8-AD1	—	592605-4
M81714/8-AH1	—	592605-2
(Class A) Size 12		
M81714/9-AA1	—	592601-8
M81714/9-AB1	—	592601-6
M81714/9-AB2	—	1-592601-2
M81714/9-AC1	—	1-592601-4
M81714/9-AC2	—	1-592601-0
M81714/9-AD1	—	592601-4
M81714/9-AH1	—	592601-2
(Class B) Size 22		
M81714/6-BA1	—	592615-6
M81714/6-BB1	—	592615-4
M81714/6-BB2	—	1-592615-4
M81714/6-BB3	—	1-592615-8
M81714/6-BC1	—	1-592615-6
M81714/6-BC2	—	1-592615-2
M81714/6-BD1	—	1-592615-0
M81714/6-BE1	—	592615-8
M81714/6-BJ1	—	592615-2
(Class B) Size 20		
M81714/7-BA1	—	592611-6
M81714/7-BB1	—	592611-4
M81714/7-BB2	—	1-592611-4
M81714/7-BB3	—	1-592611-8
M81714/7-BC1	—	1-592611-6
M81714/7-BC2	—	1-592611-2
M81714/7-BD1	—	1-592611-0
M81714/7-BE1	—	592611-8
M81714/7-BJ1	—	592611-2
(Class B) Size 16		
M81714/8-BA1	—	592607-8
M81714/8-BB1	—	592607-6
M81714/8-BB2	—	1-592607-2
M81714/8-BC1	—	1-592607-4
M81714/8-BC2	—	1-592607-0
M81714/8-BD1	—	592607-4
M81714/8-BH1	—	592607-2
(Class B) Size 12		
M81714/9-BA1	—	592603-8
M81714/9-BB1	—	592603-6
M81714/9-BB2	—	1-592603-2
M81714/9-BC1	—	1-592603-4
M81714/9-BC2	—	1-592603-0
M81714/9-BD1	—	592603-4
M81714/9-BH1	—	592603-2

Military Cross Reference (Continued)

Military Part Numbers Feedthru Modules	AMP MIL Qualified Part Numbers Feedthru Modules	AMP Commercial Part Numbers Feedthru Modules
(Class C) Size 22		
M81714/6-CA1	—	592614-6
M81714/6-CB1	—	592614-4
M81714/6-CB2	—	1-592614-4
M81714/6-CB3	—	1-592614-8
M81714/6-CC1	—	1-592614-6
M81714/6-CC2	—	1-592614-2
M81714/6-CD1	—	1-592614-0
M81714/6-CE1	—	592614-8
M81714/6-CJ1	—	592614-2
(Class C) Size 20		
M81714/7-CA1	—	592610-6
M81714/7-CB1	—	592610-4
M81714/7-CB2	—	1-592610-5
M81714/7-CB3	—	1-592610-9
M81714/7-CC1	—	1-592610-7
M81714/7-CC2	—	1-592610-3
M81714/7-CD1	—	1-592610-1
M81714/7-CE1	—	592610-8
M81714/7-CJ1	—	592610-2
(Class C) Size 16		
M81714/8-CA1	—	592606-8
M81714/8-CB1	—	592606-6
M81714/8-CB2	—	1-592606-2
M81714/8-CC1	—	1-592606-4
M81714/8-CC2	—	1-592606-0
M81714/8-CD1	—	592606-4
M81714/8-CH1	—	592606-2
(Class C) Size 12		
M81714/9-CA1	—	592602-8
M81714/9-CB1	—	592602-6
M81714/9-CB2	—	1-592602-2
M81714/9-CC1	—	1-592602-4
M81714/9-CC2	—	1-592602-0
M81714/9-CD1	—	592602-4
M81714/9-CH1	—	592602-2

