

Wirewound Resistors, Military, MIL-PRF-18546 Qualified, Type RE, Aluminum Housed, Chassis Mount

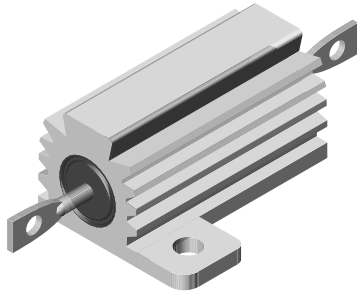

FEATURES

- Molded construction for total environmental protection
- Complete welded construction
- Meets applicable requirements of MIL-PRF-18546
- Available in non-inductive styles (type NH) with Aryton-Perry winding for lowest reactive components
- Mounts on chassis to utilize heat-sink effect
- Excellent stability in operation

STANDARD ELECTRICAL SPECIFICATIONS

MODEL	MIL-PRF-18546 TYPE	POWER RATING $P_{25^{\circ}\text{C}}$ W		RESISTANCE RANGE MIL. RANGE SHOWN IN BOLD FACE Ω				WEIGHT (Typical) g
		DALE	MILITARY	$\pm 0.05\%$, $\pm 0.1\%$	$\pm 0.25\%$	$\pm 0.5\%$	$\pm 1\%$, $\pm 3\%$, $\pm 5\%$	
RH-5	— RE60G	7.5 (5)	5	0.5 - 6.75k —	0.1 - 8.6k —	0.05 - 8.6k —	0.02 - 24.5k 0.10 - 3.32k	3
NH-5	— RE60N	7.5 (5)	5	0.5 - 2.32k —	0.1 - 3.27k —	0.05 - 3.27k —	0.05 - 12.75k 1.0 - 1.65k	3.3
RH-10	— RE65G	12.5 (10)	10	0.5 - 12.7k —	0.1 - 16.69k —	0.05 - 16.69k —	0.01 - 47.1k 0.10 - 5.62k	6
NH-10	— RE65N	12.5 (10)	10	0.5 - 4.45k —	0.1 - 5.54k —	0.05 - 5.54k —	0.05 - 23.5k 1.0 - 2.8k	8.8
RH-25	— RE70G	25	20	0.5 - 25.7k —	0.1 - 32.99k —	0.05 - 32.99k —	0.01 - 95.2k 0.10 - 12.1k	13
NH-25	— RE70N	25	20	0.5 - 9.09k —	0.1 - 12.8k —	0.05 - 12.8k —	0.05 - 47.6k 1.0 - 6.04k	16.5
RH-50	— RE75G	50	30	0.5 - 73.4k —	0.1 - 96k —	0.05 - 96k —	0.01 - 273k 0.10 - 39.2k	28
NH-50	— RE75N	50	30	0.5 - 26k —	0.1 - 36.7k —	0.05 - 36.7k —	0.05 - 136k 1.0 - 19.6k	35
RH-100	— RE77G	100	75	0.5 - 90k —	0.1 - 90k —	0.05 - 90k —	0.05 - 90k 0.05 - 29.4k	400
NH-100	— RE77N	100	75	0.5 - 37.5k —	0.1 - 37.5k —	0.05 - 37.5k —	0.05 - 37.5k 1.0 - 14.7k	440
RH-250	— RE80G	250	120	0.5 - 116k —	0.1 - 116k —	0.05 - 116k —	0.05 - 116k 0.10 - 35.7k	800
NH-250	— RE80N	250	120	0.5 - 48.5k —	0.1 - 48.5k —	0.05 - 48.5k —	0.05 - 48.5k 1.0 - 17.4k	880

NOTE: Figures in parentheses on RH-5 and RH-10 indicate wattage printed on parts, new construction allows these resistors to be rated at higher wattage but will **only** be printed with the higher wattage on customer request.

ORDERING INFORMATION

RH-50	10 Ω	1.0%
MODEL	RESISTANCE	TOLERANCE
	Ω	\pm %



Wirewound Resistors, Military, MIL-PRF-18546 Qualified,
Type RE, Aluminum Housed, Chassis Mount

DIMENSIONS

RH-5, -10, -25, -50
NH-5, -10, -25, -50

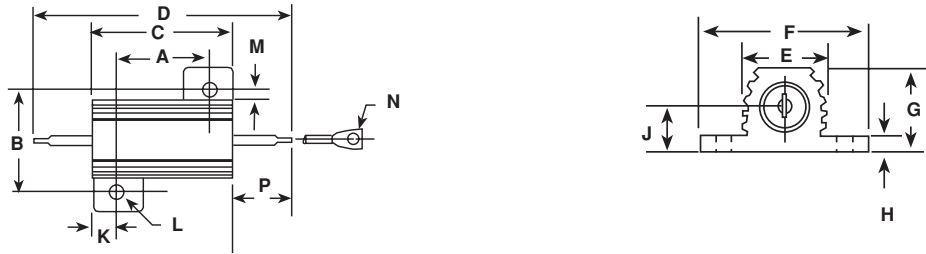

MODEL	DIMENSIONS in inches [millimeters]													
	A	B	C	D	E	F	G	H	J	K	L	M	N	P
RH-5 NH-5	0.444 ± 0.005 [11.28 ± 0.127]	0.490 ± 0.005 [12.45 ± 0.127]	0.600 ± 0.031 [15.24 ± 0.787]	1.125 ± 0.062 [28.58 ± 1.57]	0.334 ± 0.015 [8.48 ± 0.381]	0.646 ± 0.015 [16.41 ± 0.381]	0.320 ± 0.015 [8.13 ± 0.381]	0.065 ± 0.010 [1.65 ± 0.254]	0.133 ± 0.010 [3.38 ± 0.254]	0.078 ± 0.010 [1.98 ± 0.254]	0.093 ± 0.005 [2.36 ± 0.127]	0.078 ± 0.015 [1.98 ± 0.381]	0.050 ± 0.005 [1.27 ± 0.127]	0.266 ± 0.062 [6.76 ± 1.57]
RH-10 NH-10	0.562 ± 0.005 [14.27 ± 0.127]	0.625 ± 0.005 [15.88 ± 0.127]	0.750 ± 0.031 [19.05 ± 0.787]	1.375 ± 0.062 [34.93 ± 1.57]	0.420 ± 0.015 [10.67 ± 0.381]	0.800 ± 0.015 [20.32 ± 0.381]	0.390 ± 0.015 [9.91 ± 0.381]	0.075 ± 0.010 [1.91 ± 0.254]	0.165 ± 0.010 [4.19 ± 0.254]	0.093 ± 0.010 [2.36 ± 0.254]	0.094 ± 0.005 [2.39 ± 0.127]	0.102 ± 0.015 [2.59 ± 0.381]	0.085 ± 0.005 [2.16 ± 0.127]	0.312 ± 0.062 [7.92 ± 1.57]
RH-25 NH-25	0.719 ± 0.005 [18.26 ± 0.127]	0.781 ± 0.005 [19.84 ± 0.127]	1.062 ± 0.031 [26.97 ± 0.787]	1.938 ± 0.062 [49.23 ± 1.57]	0.550 ± 0.015 [13.97 ± 0.381]	1.080 ± 0.015 [27.43 ± 0.381]	0.546 ± 0.015 [13.87 ± 0.381]	0.075 ± 0.010 [1.91 ± 0.254]	0.231 ± 0.010 [5.87 ± 0.254]	0.172 ± 0.010 [4.37 ± 0.254]	0.125 ± 0.005 [3.18 ± 0.127]	0.115 ± 0.015 [2.92 ± 0.381]	0.085 ± 0.005 [2.16 ± 0.127]	0.438 ± 0.062 [11.13 ± 1.57]
RH-50 NH-50	1.562 ± 0.005 [39.67 ± 0.127]	0.844 ± 0.005 [21.44 ± 0.127]	1.968 ± 0.031 [49.99 ± 0.787]	2.781 ± 0.062 [70.64 ± 1.57]	0.630 ± 0.015 [16.00 ± 0.381]	1.140 ± 0.015 [28.96 ± 0.381]	0.610 ± 0.015 [15.49 ± 0.381]	0.088 ± 0.010 [2.24 ± 0.254]	0.260 ± 0.010 [6.60 ± 0.254]	0.196 ± 0.010 [4.98 ± 0.254]	0.125 ± 0.005 [3.18 ± 0.127]	0.107 ± 0.015 [2.72 ± 0.381]	0.085 ± 0.005 [2.16 ± 0.127]	0.438 ± 0.062 [11.13 ± 1.57]

RH-100, NH-100

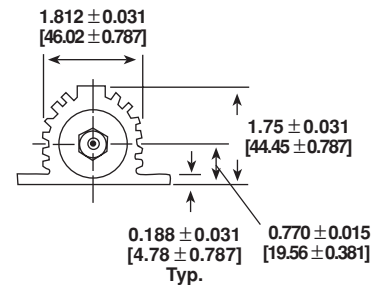
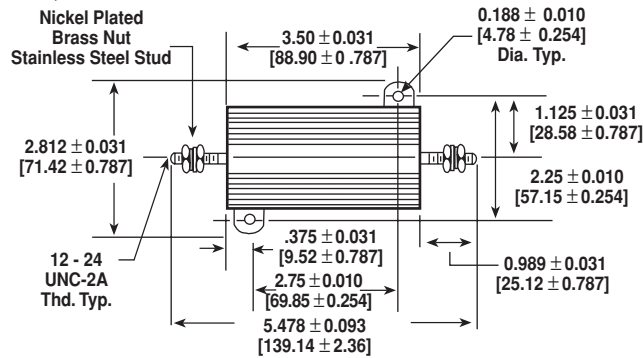

RH-250, NH-250

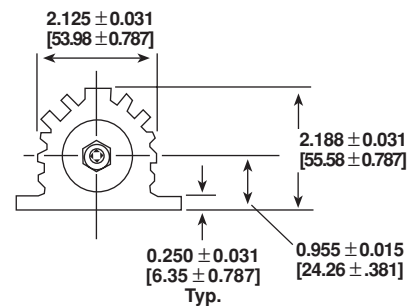
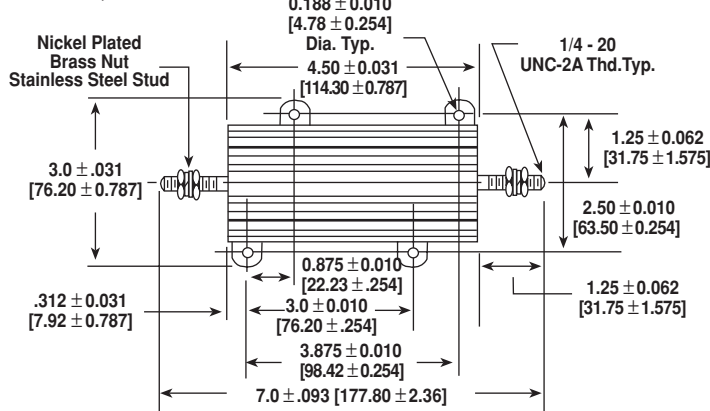

TECHNICAL SPECIFICATIONS		
PARAMETER	UNIT	RH RESISTOR CHARACTERISTICS
Temperature Coefficient	ppm/°C	± 100 for 0.1Ω to 0.99Ω, ± 50 for 1Ω to 9.9Ω, ± 20 for 10Ω and above
Dielectric Withstanding Voltage	V _{AC}	1000 for RH-5, RH-10 and RH-25, 2000 for RH-50, 4500 for RH-100 and RH-250
Short Time Overload	-	5 x rated power for 5 seconds
Maximum Working Voltage	V	(P X R) ^{1/2}
Insulation Resistance	Ω	10,000 Megohm minimum dry, 1000 Megohm minimum after moisture test
Terminal Strength	lb	5 minimum for RH-5 and RH-10, 10 minimum for all others
Solderability	-	MIL-PRF-18546 Type - Meets requirements of ANSI J-STD-002
Operating Temperature Range	°C	- 55/+ 250

POWER RATING

Vishay RH resistor wattage ratings are based on mounting to the following heat sink:

- RH-5 and RH-10: 4" x 6" x 2" x 0.040" thick aluminum chassis (129 sq. in. surface area)
- RH-25: 5" x 7" x 2" x 0.040" thick aluminum chassis (167 sq. in. surface area)
- RH-50: 12" x 12" x 0.059" thick aluminum panel (291 sq. in. surface area)
- RH-100 and RH-250: 12" x 12" x 0.125" thick aluminum panel (294 sq. in. surface area)

AMBIENT TEMPERATURE DERATING

Derating is required for ambient temperatures above 25°C, see the following graph.

Curves **A**, **B**, **C** apply to operation of unmounted resistors. Curve **D** applies to all types when mounted to specified heat sink.

- A** = RH-5 and RH-10 size resistor, unmounted
- B** = RH-25 size resistor, unmounted
- C** = RH-50, RH-100 and RH-250 size resistor, unmounted
- D** = All types mounted to recommended aluminum heat sink

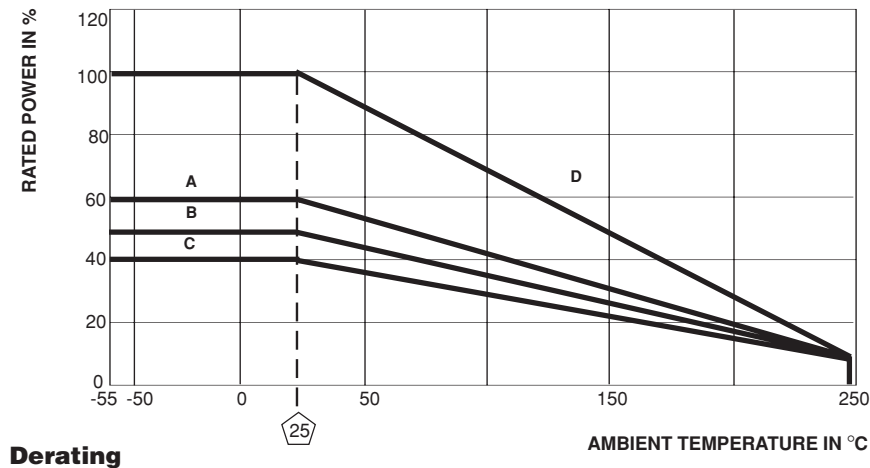

REDUCED HEAT SINK DERATING:

Derating is also required when recommended heat sink area is reduced.

- A** = RH-5 and RH-10 size resistor
- B** = RH-25 size resistor
- C** = RH-50, RH-100 and RH-250 size resistor

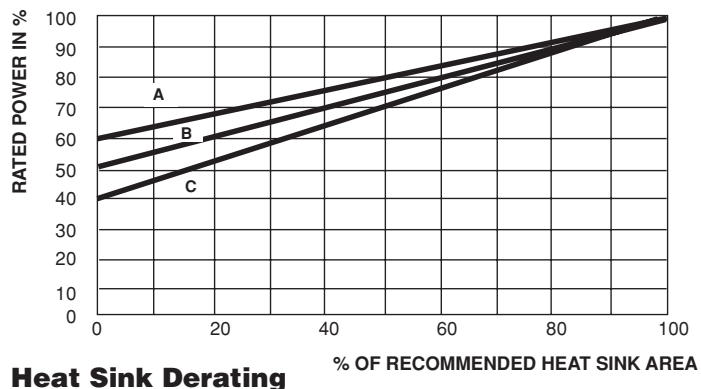



MATERIAL SPECIFICATIONS

Element: Copper-nickel alloy or nickel-chrome alloy, depending on resistance value

Core: Ceramic, steatite or alumina, depending on physical size

Encapsulant: Silicone molded construction

Housing: Aluminum with hard anodic coating

End Caps: Stainless steel

Standard Terminals: Tinned Copperweld® on RH-5 through RH-50 size, threaded stainless steel terminals on RH-100 and RH-250

Part Marking: DALE, Model, Wattage, Value, Tolerance, Date Code

NH NON-INDUCTIVE

Models of equivalent physical and electrical specifications are available with non-inductive (Aryton-Perry) winding. They are identified by substituting the letter N for R in the model number (NH-5, for example).

SPECIAL MODIFICATIONS

A number of special modifications to the aluminum housed resistor style are available upon request. Special modifications include:

- Terminal configurations and materials
- Resistance values and tolerances
- Low resistance temperature coefficient (RTC)
- Housing configuration
- Threaded mounting holes
- Preconditioning and other additional testing

APPLICABLE MIL SPECIFICATIONS

MIL-PRF-18546 is the military specification covering aluminum housed, chassis mount, power resistors. VISHAY RH and NH resistors are listed as qualified on the MIL-PRF-18546 QPL.

PERFORMANCE		
TEST	CONDITIONS OF TEST	TEST LIMITS
Thermal Shock	Rated power applied until thermally stable, then a minimum of 15 minutes at - 55°C	± (0.5% + 0.05Ω) ΔR
Short Time Overload	5 x rated power for 5 seconds	± (0.5% + 0.05Ω) ΔR
Dielectric Withstanding Voltage	1000Vrms for RH-5, RH-10 and RH-25; 2000Vrms for RH-50 4500Vrms for RH-100 and RH-250; duration one minute	± (0.2% + 0.05Ω) ΔR
Temperature	250°C for 2 hours	± (0.5% + 0.05Ω) ΔR
Moisture Resistance	MIL-STD-202 Method 106, 7b not applicable	± (1.0% + 0.05Ω) ΔR
Shock, Specified Pulse	MIL-STD-202 Method 213, 100g's for 6 milliseconds, 10 shocks	± (0.2% + 0.05Ω) ΔR
Vibration, High Frequency	Frequency varied 10 to 2000Hz, 20g peak, 2 directions 6 hours each	± (0.2% + 0.05Ω) ΔR
Load Life	1000 hours at rated power, + 25°C, 1.5 hours "ON", 0.5 hours "OFF"	± (1.0% + 0.05Ω) ΔR
Terminal Strength	30 second, 5 pound pull test for RH-5 and RH-10, 10 pound pull test for other sizes, torque test - 24 pound inch for RH-100 and 32 pound inch for RH-250	± (0.2% + 0.05Ω) ΔR