

PME295RB3680MR19T0

aka P295BE681M440L

Capacitor, film, 680 pF, +/-20% Tol, -40/+115C, Safety: Y1, 440VAC,
Lead Spacing=15 mm

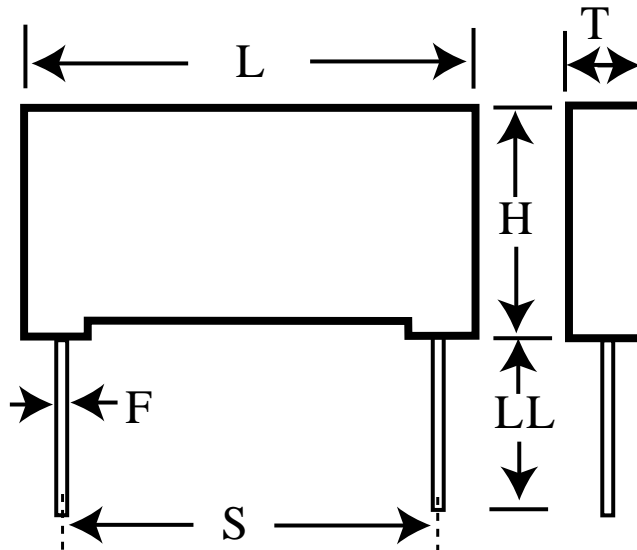

Dimensions (mm)

ID	Dimension	Tolerance
L	18	max
H	12.5	max
T	5.5	max
S	15	+/-0.4
LL	19	nom
F	0.8	nom

Specifications

Manufacturer:	KEMET
Brand:	Rifa
Capacitance:	680 pF
Temperature Range:	-40/+115C
Rated Temperature:	115C
Voltage @ rated temp:	1500V
Voltage AC:	440VAC
Tolerance:	+/-20%
Body Type:	Radial Molded
Construction:	Non-inductive
Application:	Safety: Y1
Dielectric:	Metallized Paper
Dissipation Factor @ 1 kHz:	1.3%
Insulation Resistance:	12 GOhm
Maximum dVdT:	2000v/us
UL_1414:	250V
UL_1283:	480V
IEC_60384-14:	440V
EN_132400:	440V
C_22.2_NO.1:	250V
C_22.2_NO.8:	480V
Miscellaneous Electrical:	PME295
Package Kind:	T&R
Package Size:	360mm
Package Quantity:	600