

MINIATURE RELAY

1 POLE—1 to 2A (FOR SIGNAL SWITCHING)

SY SERIES

RoHS compliant



■ FEATURES

- Very small size and light weight
- UL, CSA recognized
- Conforms to FCC rules and regulations part 68
 - Dielectric strength 1000 VAC between coil and contacts
 - Surge strength 1500 V
- High sensitivity
- Wide ambient temperature range (-30°C to +90°C)
- Wide operating range
- DIL pitch terminals
- Plastic sealed type
- Dial-pulse relay available (10pps, 20pps)
- RoHS compliant since date code: 0519
Please see page 5 for more information



■ ORDERING INFORMATION

[Example] $\frac{SY}{(a)} - \frac{12}{(b)} \frac{W}{(c)} - \frac{K}{(d)}$

(a)	Series Name	SY: SY Series
(b)	Nominal Voltage	Refer to the COIL DATA CHART
(c)	Contact	Nil: Single type W: Bifurcated type
(d)	Enclosure	K: Plastic sealed type

Note: For movable and stationary contact with gold overlay type, add suffix “-OH”

■ COIL DATA CHART

MODEL		Nominal voltage	Coil resistance ($\pm 10\%$)	Must operate voltage	Must release voltage	Nominal power
Single	Bifurcated					
SY-1.5-K	SY-1.5W-K	1.5 VDC	15 Ω	1.05 VDC	0.08 VDC	150 mW
SY- 3 -K	SY- 3 W-K	3 VDC	60 Ω	2.1 VDC	0.15 VDC	150 mW
SY-4.5-K	SY-4.5W-K	4.5 VDC	135 Ω	3.2 VDC	0.23 VDC	150 mW
SY- 5 -K	SY- 5 W-K	5 VDC	167 Ω	3.5 VDC	0.25 VDC	150 mW
SY- 6 -K	SY- 6 W-K	6 VDC	240 Ω	4.2 VDC	0.3 VDC	150 mW
SY- 9 -K	SY- 9 W-K	9 VDC	540 Ω	6.3 VDC	0.45 VDC	150 mW
SY-12 -K	SY-12 W-K	12 VDC	960 Ω	8.4 VDC	0.6 VDC	150 mW
SY-18 -K	SY-18 W-K	18 VDC	1,940 Ω	12.6 VDC	0.9 VDC	170 mW
SY-24 -K	SY-24 W-K	24 VDC	3,290 Ω	16.8 VDC	1.2 VDC	175 mW

Note : All values in the table are measured at 20°C.

■ SPECIFICATIONS

Item		SY-() -K (Single)	SY-() W - K (Bifurcated)	
Contact	Arrangement	1 form C (SPDT)		
	Material	Gold overlay silver palladium		
	Configuration	Single (cross bar)	Bifurcated (cross bar)	
	Resistance (initial)	Maximum 100 mΩ (at 1 A 6 VDC)		
	Rating (resistive)	0.5 A 120 VAC or 1 A 24 VDC		
	Maximum Carrying Current	2 A		
	Maximum Switching Power	60 AV, 24 W		
	Maximum Switching Voltage	120 VAC/60 VDC		
	Maximum Switching Current	1 A		
	Minimum Switching Load* ¹	1 mA 1 VDC	0.1 mA 100 mVDC	
	Capacitance (at 10 MHz)	Approximately 1.4 pF (between open contacts) Approximately 5.0 pF (between coil and contacts)		
Coil	Nominal Power (at 20°C)	150 to 175 mW		
	Operate Power (at 20°C)	75 to 86 mW		
	Operating Temperature	-30°C to +90°C (no frost)/18 V coil: +85°C, 24 V coil: +80°C		
Time Value	Operate (at nominal voltage)	Maximum 5 ms		
	Release (at nominal voltage)	Maximum 2 ms		
Life	Mechanical	5 × 10 ⁶ operations minimum		
	Electrical (at contact rating)	1 × 10 ⁵ operations minimum		
Other	Vibration	Misoperation	10 to 55 Hz (double amplitude of 1.5 mm)	
		Resistance	Endurance	10 to 55 Hz (double amplitude of 1.5 mm)
	Shock	Misoperation	300 m/s ² (11 ±1 ms)	
		Resistance	Endurance	1,000 m/s ² (6 ±1 ms)
	Weight	Approximately 1.7 g		

*¹ Minimum switching loads mentioned above are reference values. Please perform the confirmation test with the actual load before production since reference values may vary according to switching frequencies, environmental conditions and expected reliability levels.

■ INSULATION

Item		Single	Bifurcated
Resistance (initial)		Minimum 1,000 MΩ (500VDC)	Minimum 1,000 MΩ (250VDC)
Dielectric Strength	open contacts	400 VAC 1 min.	300 VAC 1 min.
	coil and contacts	1,000 VAC 1 min.	
Surge Voltage		1500V (coil-contact) (10/160 μs standard wave)	

SAFETY STANDARD AND FILE NUMBERS

Type	Compliance	Contact rating
UL	UL 508, 873 E 45026	Flammability: UL 94-V0 (plastics) [SJ-() A01] 1A, 265VAC (resistive) [SJ-() D01]
CSA	C22.2 No. 14 LR 35579	1A, 30VDC (resistive)

CHARACTERISTIC DATA

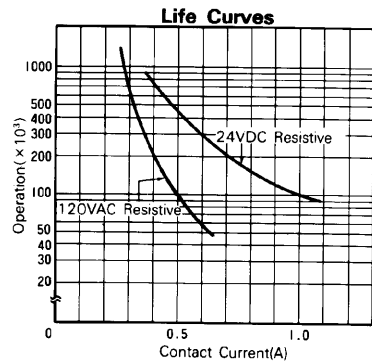
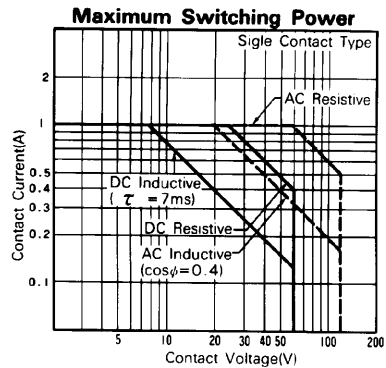
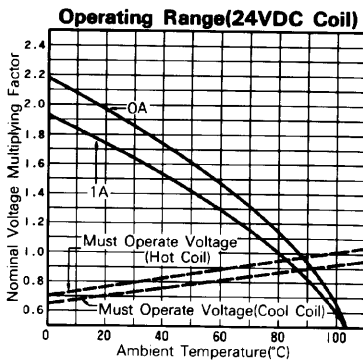
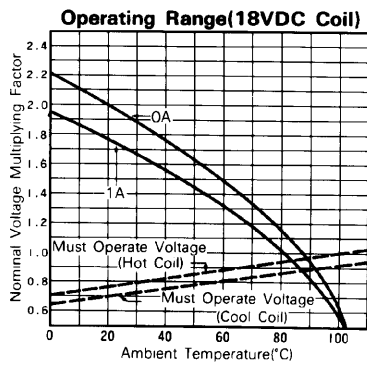
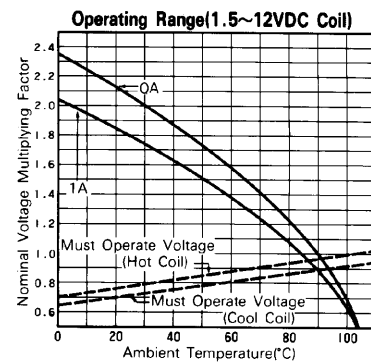
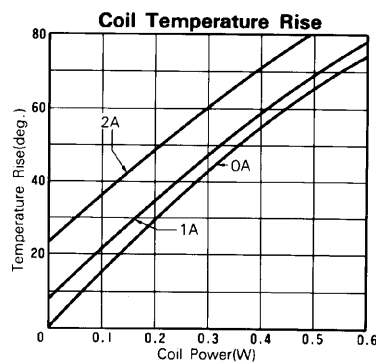
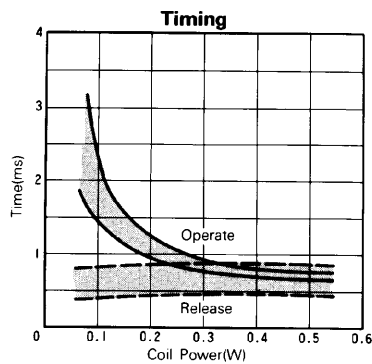

REFERENCE DATA

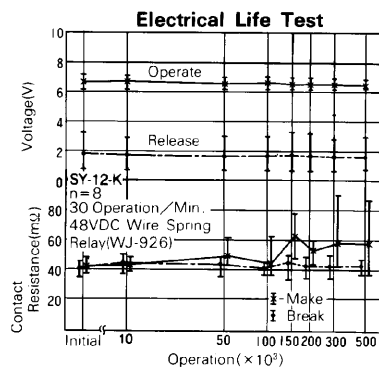
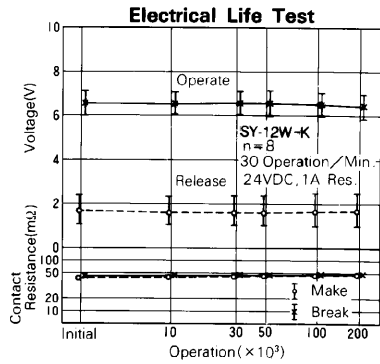
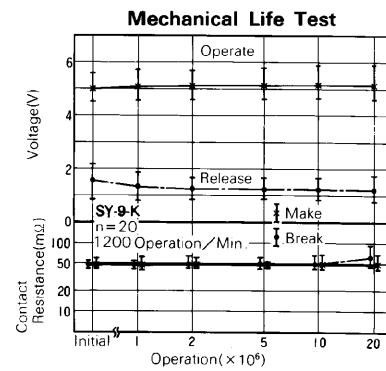
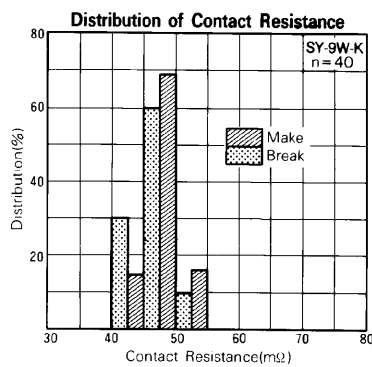
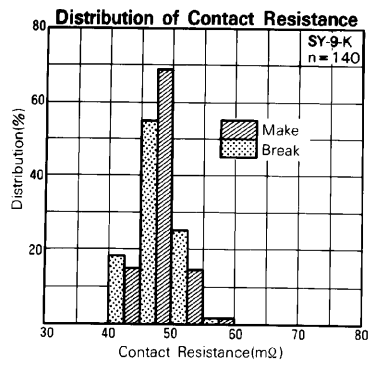
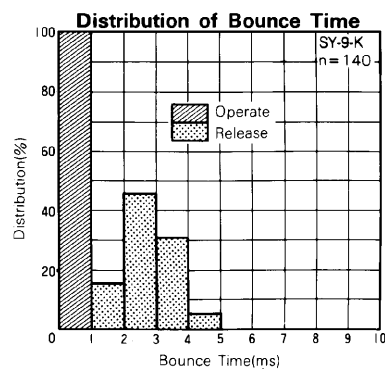
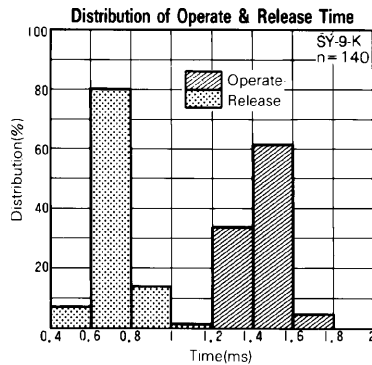
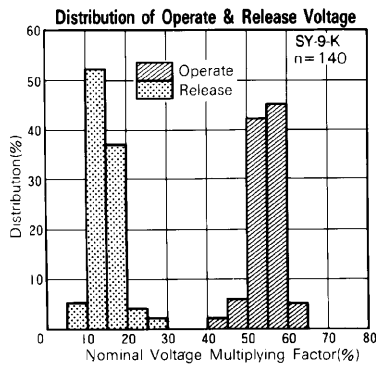

DIMENSIONS

Dimensions

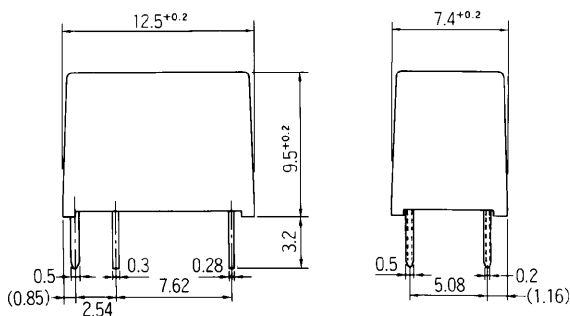

Schematics (Bottom View)



PC board mounting hole layout (Bottom View)

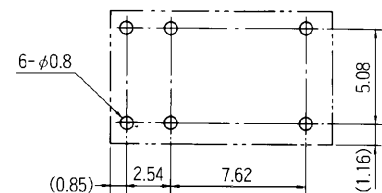

Unit: mm

RoHS Compliance and Lead Free Relay Information

1. General Information

- Relays produced after the specific date code that is indicated on each data sheet are lead-free now. Most of our signal and power relays are lead-free. Please refer to Lead-Free Status Info. (<http://www.fujitsu.com/us/downloads/MICRO/fcai/relays/lead-free-letter.pdf>)
- Lead free solder paste currently used in relays is Sn-3.0Ag-0.5Cu.
- All signal and most power relays also comply with RoHS. Please refer to individual data sheets. Relays that are RoHS compliant do not contain the 5 hazardous materials that are restricted by RoHS directive (lead, mercury, chromium IV, PBB, PBDE).
- It has been verified that using lead-free relays in leaded assembly process will not cause any problems (compatible).
- "LF" is marked on each outer and inner carton. (No marking on individual relays).
- To avoid leaded relays (for lead-free sample, etc.) please consult with area sales office.
- We will ship leaded relays as long as the leaded relay inventory exists.

Note: Cadmium was exempted from RoHS on October 21, 2005. (Amendment to Directive 2002/95/EC)

2. Recommended Lead Free Solder Profile

- Recommended solder paste Sn-3.0Ag-0.5Cu.

Reflow Solder condition

Flow Solder condition:

Pre-heating: maximum 120°C
Soldering: dip within 5 sec. at
260°C solder bath

Solder by Soldering Iron:

Soldering Iron
Temperature: maximum 360°C
Duration: maximum 3 sec.

We highly recommend that you confirm your actual solder conditions

3. Moisture Sensitivity

- Moisture Sensitivity Level standard is not applicable to electromechanical relays.

4. Tin Whisker

- Dipped SnAgCu solder is known as low risk tin whisker. No considerable length whisker was found by our in house test.

Fujitsu Components International Headquarter Offices

Japan

Fujitsu Component Limited
Gotanda-Chuo Building
3-5, Higashigotanda 2-chome, Shinagawa-ku
Tokyo 141, Japan
Tel: (81-3) 5449-7010
Fax: (81-3) 5449-2626
Email: promothq@ft.ed.fujitsu.com
Web: www.fcl.fujitsu.com

North and South America

Fujitsu Components America, Inc.
250 E. Caribbean Drive
Sunnyvale, CA 94089 U.S.A.
Tel: (1-408) 745-4900
Fax: (1-408) 745-4970
Email: components@us.fujitsu.com
Web: <http://www.fujitsu.com/us/services/edevice/components/>

Europe

Fujitsu Components Europe B.V.
Diamantlaan 25
2132 WV Hoofddorp
Netherlands
Tel: (31-23) 5560910
Fax: (31-23) 5560950
Email: info@fceu.fujitsu.com
Web: emea.fujitsu.com/components/

Asia Pacific

Fujitsu Components Asia Ltd.
102E Pasir Panjang Road
#01-01 Citilink Warehouse Complex
Singapore 118529
Tel: (65) 6375-8560
Fax: (65) 6273-3021
Email: fcal@fcal.fujitsu.com
Web: <http://www.fujitsu.com/sg/services/micro/components/>

©2008 Fujitsu Components America, Inc. All rights reserved. All trademarks or registered trademarks are the property of their respective owners.

Fujitsu Components America or its affiliates do not warrant that the content of datasheet is error free. In a continuing effort to improve our products Fujitsu Components America, Inc. or its affiliates reserve the right to change specifications/datasheets without prior notice.
Rev. January 11, 2008.