

NTC Thermistor SPECIFICATION

Scope

This product specification is applied to NTC Thermistor used for temperature sensor.
Please contact us when using this product for any other applications than described in the above.

1. Part No.

NCP18 SERIES

2. Ratings

P/N	Resistance (kohm) at 25°C	B-constant (K) 25/50°C	Permissive Operating Current (mA) (*1,*2)	Rated Electric Power (mW) (*1,*3)	Thermal Dissipation Constant (mW/°C) (*1)	Operating Temperature Range (°C)
NCP18XF101 03RB	0.10	3250±3%	3.10	100	Approx. 1.0	-40°C~ +125°C
NCP18XF151 03RB	0.15	3250±3%	2.50			
NCP18XM221 03RB	0.22	3500±3%	2.10			
NCP18XM331 03RB	0.33	3500±3%	1.70			
NCP18XQ471 03RB	0.47	3650±3%	1.40			
NCP18XQ681 03RB	0.68	3650±3%	1.20			
NCP18XQ102 03RB	1.0	3650±3%	1.00			
NCP18XW152 03RB	1.5	3950±3%	0.81			
NCP18XW222 03RB	2.2	3950±3%	0.67			
NCP18XW332 03RB	3.3	3950±3%	0.55			
NCP18XM472 03RB	4.7	3500±3%	0.46			
NCP18XW682 03RB	6.8	3950±3%	0.38			
NCP18XH103 03RB	10	3380±3%	0.31			
NCP18XW153 03RB	15	3950±3%	0.25			
NCP18XW223 03RB	22	3950±3%	0.21			
NCP18WB333 03RB	33	4050±3%	0.17			
NCP18WB473 03RB	47	4050±3%	0.14			
NCP18WD683 03RB	68	4150±3%	0.12			
NCP18WF104 03RB	100	4250±3%	0.10			
NCP18WM154 03RB	150	4500±3%	0.08			
NCP18WM224 03RB	220	4500±3%	0.06			
NCP18WM474 03RB	470	4500±3%	0.04			

: Resistance tolerance (K±10%,J±5%)

*1 : When measured at 25°C in still air, as a single unit without mounting.

*2 : Permissive Operating Current rises thermistor's temperature by 1°C.

The current less than 1/10 of the Permissive Operating Current value is recommended in order to prevent self heating of the NTC thermistor.

*3 : NTC Thermistor's temperature rises by approx. 100°C at 25°C in still air when Rated Electric Power (100mW) is applied.

Too rapid temperature rising, however, may cause any unexpected failures on your circuit. Please do not apply higher than 10mW of electric power in short time. (10mW of power gives NTC Thermistor approx. 10°C of temperature rising.)

The electric power related with operating temperature in shown in the graph right.

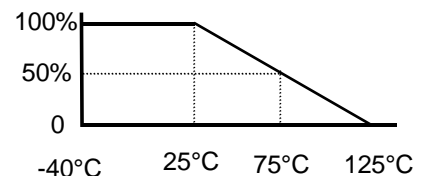

3. Dimensions

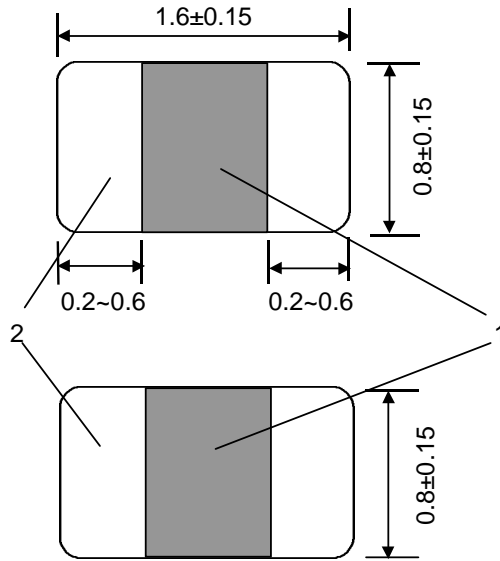

1. Thermistor

2. Electrode (Ag Alloy + Ni Plating + Sn Plating)

(Unit : mm)

4. Marking

No Marking

5. Electrical Characteristics

NO.	Item	Criteria*	Test Condition
5.1	High Temperature Test	•Resistance(R_{25}) change shall be less than $\pm 5\%$ •B-constant($B_{25/50}$) change shall be less than $\pm 2\%$ •No visible damage.	125 \pm 3°C in air, for 1000 +48/-0 hrs. without loading.
5.2	Low Temperature Test		-40 \pm 3°C in air, for 1000 +48/-0 hrs. without loading.
5.3	Humidity Test		60 \pm 2°C, 90~95%RH in air, for 1000 +48/-0 hrs. without loading.
5.4	Heat Cycle Test		5 cycles of following sequence without loading. Step Temp.(°C) Time (min.) 1 -40 +0/-3 30 2 room temp. 10~15 3 +125 +0/-3 30 4 room temp. 10~15
5.5	High Temperature Load Test		85 \pm 2°C in air, with Permissive Operating Current for 1000 +48/-0 hrs.

- * • NTC Thermistor shall be soldered on the glass epoxy PCB and be tested.
- R_{25} means the zero-power resistance at 25°C.
- $B_{25/50}$ is calculated by the zero-power resistances of NTC Thermistor at 25°C and at 50°C.
- After each test, NTC Thermistor should be kept for 1 hour at room temperature (normal humidity and normal atmospheric pressure). Then the resistances (R_{25} and R_{50}) shall be measured and the appearance shall be visually examined.

6. Mechanical Characteristics

NO.	Item	Criteria*	Test Condition
6.1	Solderability	Minimum 95% of the whole electrode surface shall be covered with solder.	Soldering Temp. : 235±5°C Solder : Sn60%/Pb40% Immersion Time : 2±0.5sec. NTC Thermistor shall be immersed completely under the solder meniscus.
6.2	Resistance to Soldering Heat	<ul style="list-style-type: none"> Resistance(R_{25}) change shall be less than ±5% B-constant($B_{25/50}$) change shall be less than ±2% No visible damage. 	Soldering Temp. : 260±5°C Solder : Sn60%/Pb40% Immersion Time : 10±0.5sec. NTC Thermistor shall be immersed Completely under the solder meniscus. Preheating Temp. : 150±5°C Preheating Time : 3min.
6.3	Adhesive Strength of Electrode	•No peeling of the electrodes.	Solder NTC Thermistor on the Glass Epoxy PCB, and apply 4.9N of force as shown below:
6.4	Vibration	<ul style="list-style-type: none"> Resistance(R_{25}) change shall be less than ±5% B-constant($B_{25/50}$) change shall be less than ±2% No visible damage. 	Solder NTC Thermistor on the Glass Epoxy PCB as shown below. Frequency: 10Hz~55Hz~10Hz(1min.) Amplitude: 1.5mm Vibrated for a period of 2hrs. in three (3) directions perpendicularly intersecting each other (for total of 6hrs.).

- * • R_{25} means the zero-power resistance at 25°C.
 • $B_{25/50}$ is calculated by the zero-power resistances of NTC Thermistor at 25°C and at 50°C.
 • After each test, NTC Thermistor should be kept for 1 hour at room temperature (normal humidity and normal atmospheric pressure). Then the resistances (R_{25} and R_{50}) shall be measured and the appearance shall be visually examined.

7. Taping Specification

7.1 Dimensions of paper tape

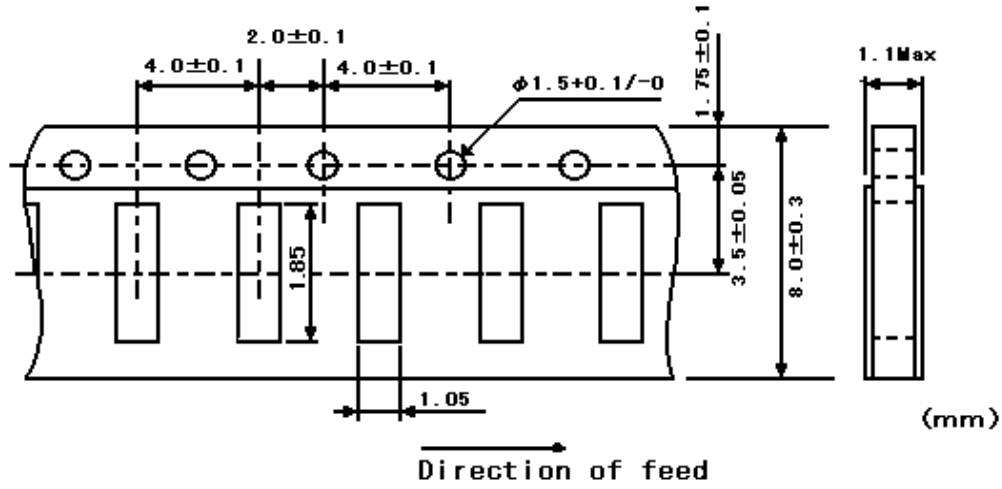

- (1) Products shall be packaged in the cavity of the base tape and sealed by top tape and bottom tape.
- (2) Top tape and bottom tape have no joints and products shall be packaged and sealed in the cavity of the base tape, continuously.

7.2 Tape strength

(1) Pull strength of top tape and bottom tape shall be specified as follows:

Top tape	Bottom tape
5 N minimum	5 N minimum

(2) Peeling force of top tape

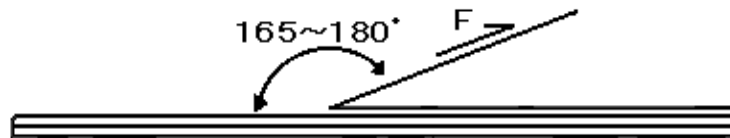

- * 1 peeling angle : 165 to 180 degree against the fixed surface of tape.
- * 2 peeling speed : 300mm/min.
- * 3 Peeling force : 0.1 ~ 0.6 N

7.3 Reeling

(1) Quantity (Standard Quantity)

Products quantity in a reel
4,000 pcs./1 reel

(2) A tape in a reel contains Leader unit and Trailer unit where products are not packed.
(See the following figure.)

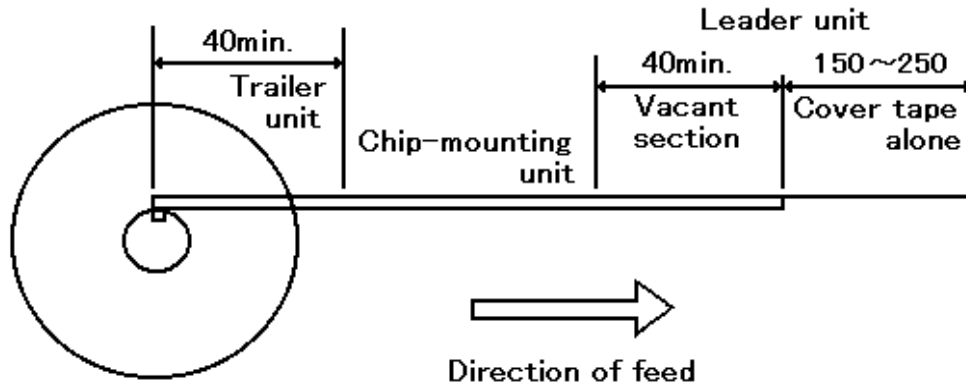

(mm)

* The reeling specification above shall not be applied for the order less than 4,000pcs.

(3) A label shall be attached on the reel. (MURATA's part number, inspection number and quantity shall be marked on the label.)

(4) Taping reels shall be packed in a inner package.

(5) Dimensions of reel

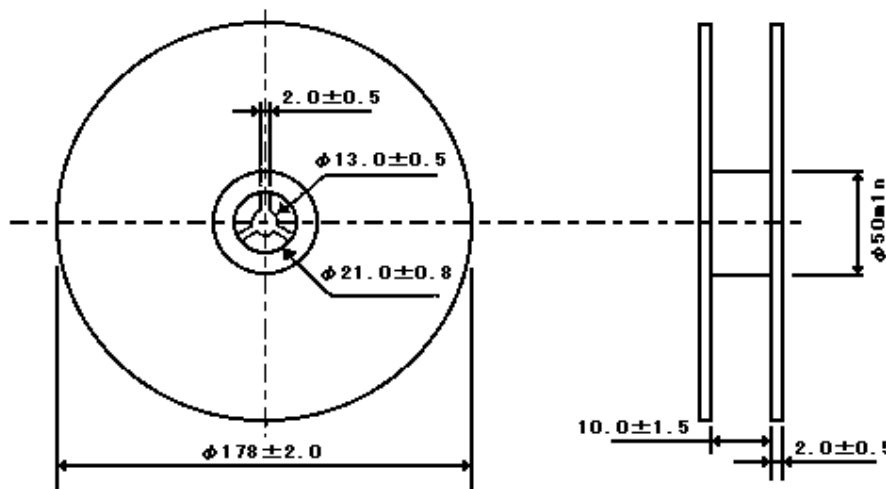

(mm)

8. Packaging

The inner package shall be packed in a outer package.

The label shall be attached on the outer package.

(Customer's name, order number, customer's part number, MURATA's part number and quantity shall be marked on a label.)

for users

 CAUTION

1. Applying the power exceeding the specified 'Rated Electric Power' may causes deterioration of the characteristics or destruction of this product. Do not apply the power exceeding the 'Rated Electric Power'.
2. This product is designed for the applications under ordinary environment (room temperature, normal humidity and atmospheric pressure). Do not use under the following environments. Because all these factors can deteriorate the characteristics of product or can cause the failures and the burning-out.
 - (1) corrosive gas or deoxidizing gas (Cl₂, H₂S, NH₃, SO_x, NO_x, etc.)
 - (2) volatile or flammable gas
 - (3) dusty place
 - (4) under vacuum, reducing pressure or under high-pressure
 - (5) place with splashed water or under high humidity with dewing
 - (6) place with salt water, oils, chemical liquids or organic solvents
 - (7) place strongly vibrated
 - (8) other place, where is similar like the above-mentioned environments
3. Please contact us before using this product for the under-mentioned applications requiring, especially high reliability, in order to prevent defects which might directly cause damage to other party's life, body or property. (Listed below.)
 - (1) Aircraft equipment
 - (2) Aerospace equipment
 - (3) Undersea equipment
 - (4) Nuclear power control equipment
 - (5) Medical equipment
 - (6) Transportation equipment (automobiles, trains, ships, etc.)
 - (7) Traffic signal equipment
 - (8) Disaster prevention / Crime prevention equipment
 - (9) Data-processing equipment
 - (10) Applications of similar complexity or with reliability requirements comparable to the applications listed in the above
4. Be sure to provide an appropriate fail-safe function on your product to prevent a second damage that may be caused by the abnormal function or the failure of our product.

NOTICE

1. Use this product within the specified temperature range. Higher temperature may cause deterioration of the characteristics or the material quality of this product.
2. Following conditions should be kept in order to avoid deterioration of solderability of external electrodes and the characteristics of this products.
 - (1) Storage Condition: Temperature: -10°C to +40°C
Humidity: less than 75 %RH, without dewing.
 - (2) Storage Term: Use this product within 6 months after delivery. If 6 months or more elapsed, please check the solderability before use.
 - (3) Handling: After unpacking, reseal promptly this product or store it in a sealed container with a drying agent.
 - (4) Storage Place: Store this product in no corrosive gas (SO_x, Cl, etc.), nor directly under sunshine.

3. Solder and Flux

(1) Solder Paste

- i. Reflow Soldering: Use RA type or equivalent type of solder paste
(Sn:Pb:Ag=63:35:2wt%, Sn:Pb=60:40wt% or Sn:Pb=63:37wt%)
- ii. Reflow Soldering: Use RA type or equivalent type of solder paste
(Sn:Pb:Ag=63:35:2wt%, Sn:Pb=60:40wt% or Sn:Pb=63:37wt%)

For your reference, we are using 'SPT-70-0F-2063', manufactured by SENJU METAL INDUSTRY CO., LTD (Sn:Pb:Ag=63:35:2wt%), for any Internal tests of this product.

- (2) Flux: Use rosin-based flux.
Do not use strong acidic flux (with halide content exceeding 0.2wt%).

4. For removing the flux after soldering, observe the following points in order to avoid deterioration of the characteristics or any change of the external electrodes quality.

(1) Cleaning Conditions

Solvent	Dipping Cleaning	Ultrasonic Cleaning
Isopropyl Alcohol	Less than 5 min. at room temp. or Less than 2 min. at 40°C max.	Less than 1 min. 20W/L Frequency of several 10 KHz to several 100 KHz.

A sufficient cleaning shall be applied to remove flux completely.

- (2) Drying: After cleaning, dry promptly this product.

5. Do not give this product a strong press-force nor a mechanical shock. Because such mechanical forces may cause cracking or chipping of this ceramic product.

6. In your mounting process, observe the following points in order to avoid deterioration of the characteristics or destruction of this product. The mounting quality of this product may also be affected by the mounting conditions, shown the points below.

(1) Recommendable Land Size

Too big land size gives too much solder paste on the land. It may cause destruction of this product, because of the mechanical stress especially in the case of board bending.

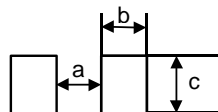

	a	b	c
Flow Soldering	0.6 - 1.0	0.8 - 0.9	0.6 - 0.8
Reflow Soldering	0.6 - 0.8	0.6 - 0.7	0.6 - 0.8

(Unit : mm)

(2) Printing Conditions of Solder Paste

- i. Recommendable thickness of solder paste printing shall be from 0.15 mm to 0.20 mm.
- ii. After soldering, the solder fillet shall be a height from 0.2 mm to the thickness of this product. (See the figures below.)

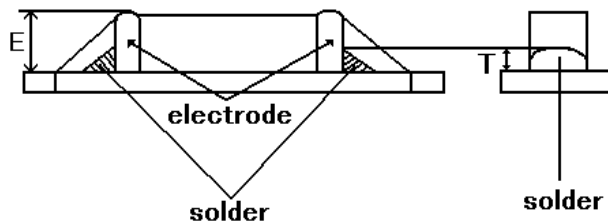

$$0.2\text{mm} \leq T \leq E$$

- iii. Too much solder gives too strong mechanical stress to this product, such stress may cause cracking or any mechanical damage. And also, it can destroy the electrical performance of this product.

(3) Adhesive Application and Curing

- i. If insufficient adhesive is applied, or if the adhesive is not sufficiently hardened, this product may have a loose contact with the land, during flow soldering.
- ii. Too low viscosity of adhesive causes this product to slip on board, after mounting.

(4) Allowable Soldering Temperature and Time

- i. Solder within the temperature and time combinations, indicated by the slanted lines in the following graphs.
- ii. The excessive soldering conditions may cause dissolution of metallization or deterioration of solder-wetting on the external electrode.
- iii. In the case that soldering is repeated more than twice, the allowable reflow soldering time should be the accumulated soldering time.

<Allowable Flow Soldering Temp. and Time>

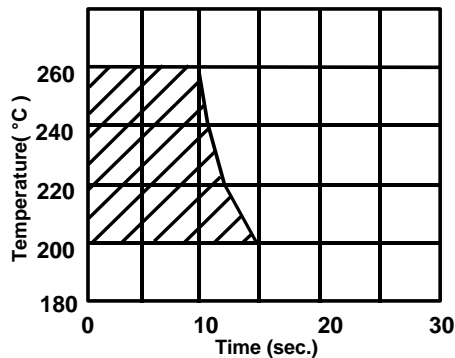

<Allowable Reflow Soldering Temp. and Time>

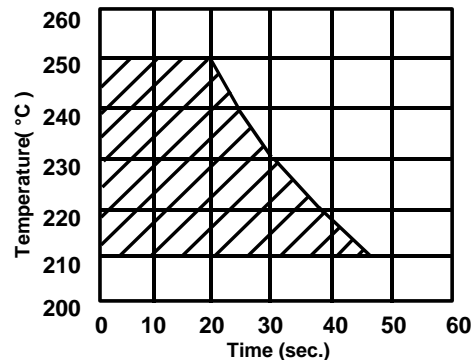

(5) Recommendable Temperature Profile for Soldering

- i. Insufficient preheating may cause a crack on ceramic body.
- ii. Rapid cooling by dipping in solvent or by other means is not recommended.

Recommended Soldering Condition

<Flow Soldering Condition>

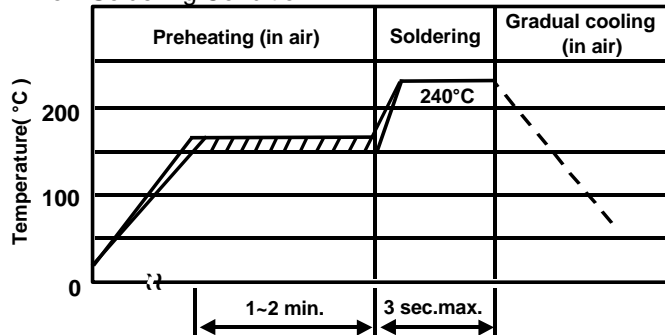

Preheating: 160 +/- 10 °C
1min. to 2 min.
Soldering: 240 °C
3sec. max.

<Reflow Soldering Condition>

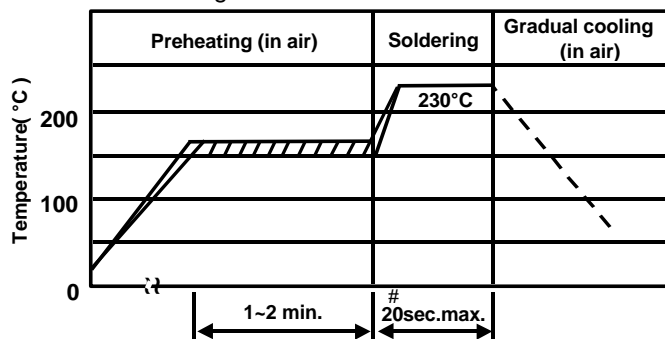

Preheating: 160 +/- 10 °C
1min. to 2 min.
Soldering: 230 °C
20sec. max.

#: In the case that reflow soldering is repeated more than twice, the accumulated soldering time should be in the above allowable reflow soldering time.

(6) There is a fear of unexpected failures (tombstone, insufficient solder-wetting, etc.) in your mounting process, caused by the mounting conditions. Please make sure if this product is correctly mounted under your mounting conditions.

(7) Reworking Conditions with Soldering Iron

The following conditions must be strictly followed using a soldering iron. Preheating at 150°C for 1 minute is recommended, before the reworking.

Item	Conditions
Temperature of Iron-tip	280°C max.
Soldering Iron Wattage	30W max.
Diameter of Iron-tip	3mm dia. max.
Soldering Time	10sec. max.
Caution	Do not allow the iron-tip to directly touch the ceramic body.

7. Location on Printed Circuit Board(PC Board)

<Component Direction>

Locate this product horizontal to the direction in which stress acts.

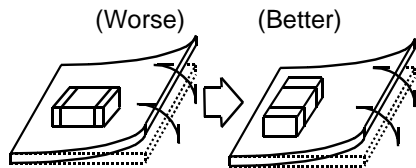

<Mounting Close to Board Separation Line>

Put this product on the PC Board near the Slit, not near the Perforation Holes.

Keep this product on the PC Board away from the Separation Line.

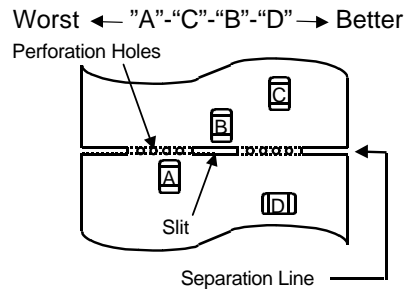

NOTE

1. Please make sure that your product has been evaluated and confirmed against your specifications when our product is mounted to your product.
2. All the items and parameters in this product specification have been prescribed on the premise that our product is used for the purpose, under the condition and in the environment agreed upon between you and us. You are requested not to use our product deviating from such agreement.