









ITW SWITCHES ROTARY SWITCHES

Design, development and manufacture of switch solutions

-  PUSH BUTTON
-  SNAP ACTION
-  ACTUATORS
-  SLIDE
-  ROTARY
-  CUSTOM ASSEMBLIES
-  MILITARY / AEROSPACE



ITW Switches
SENSORS, SWITCHES, ELECTRONIC CONTROLS



WWW.ITWSWITCHES.COM

800.544.335

ROTARY SWITCHES

Table Of Contents ii – iii

Series 030: Sub-Miniature T-05 Space Saver 78 – 79



ROTARY SWITCHES

SUB-MINIATURE T-05 SPACE SAVER ROTARY SWITCHES

This sub-miniature rotary switch has up to 8 positions in a T-05 can. Gold contacts deliver long life and reliability. Contacts are glass to metal sealed to prevent solder flux penetration. The Series 030 can be used for manually programming a single PC board for test or multi-function use.

Series 030



ACTUAL SIZE

APPLICATIONS

- Communications equipment
- Cable TV equipment
- Circuit breakers
- Timers
- Thermostatic controls

KEY FEATURES:

- Gold contacts
- Up to 8 positions
- Life: 10,000 mechanical actuation (nom.)
- Variety of actuator lengths
- Glass to metal sealed header
- PC terminals
- Sub-miniature package size (.36" diameter)

ORDERING INFORMATION:

| Part Number | Positions | Shaft Length | Custom * |
|-------------|-----------|--------------|----------------------------------|
| 030-202-018 | 2 | 0.18 | — |
| 030-303-018 | 3 | 0.18 | — |
| 030-404-018 | 4 | 0.18 | — |
| 030-404-904 | 4 | 0.05 | Black Insert, Spacer, No Post |
| 030-404-905 | 4 | 0.05 | Red Insert, Micro Plastic Spacer |
| 030-505-018 | 5 | 0.18 | — |
| 030-505-906 | 5 | 0.05 | Black Insert, Spacer, No Post |
| 030-606-018 | 6 | 0.18 | — |
| 030-606-902 | 6 | 0.30 | Black Insert, Spacer, No Post |
| 030-808-005 | 8 | 0.05 | — |
| 030-808-030 | 8 | 0.30 | — |
| 030-808-907 | 8 | 0.05 | Black Insert, Spacer, No Post |
| 030-808-908 | 8 | 0.30 | Black Insert, Spacer, No Post |
| 030-808-909 | 8 | 0.30 | No Insert, Spacer, No Post |

* Subject to change without notice, all orders are NC & NR.

STANDARDS / AGENCY / RATINGS:



030-XOX-XXX

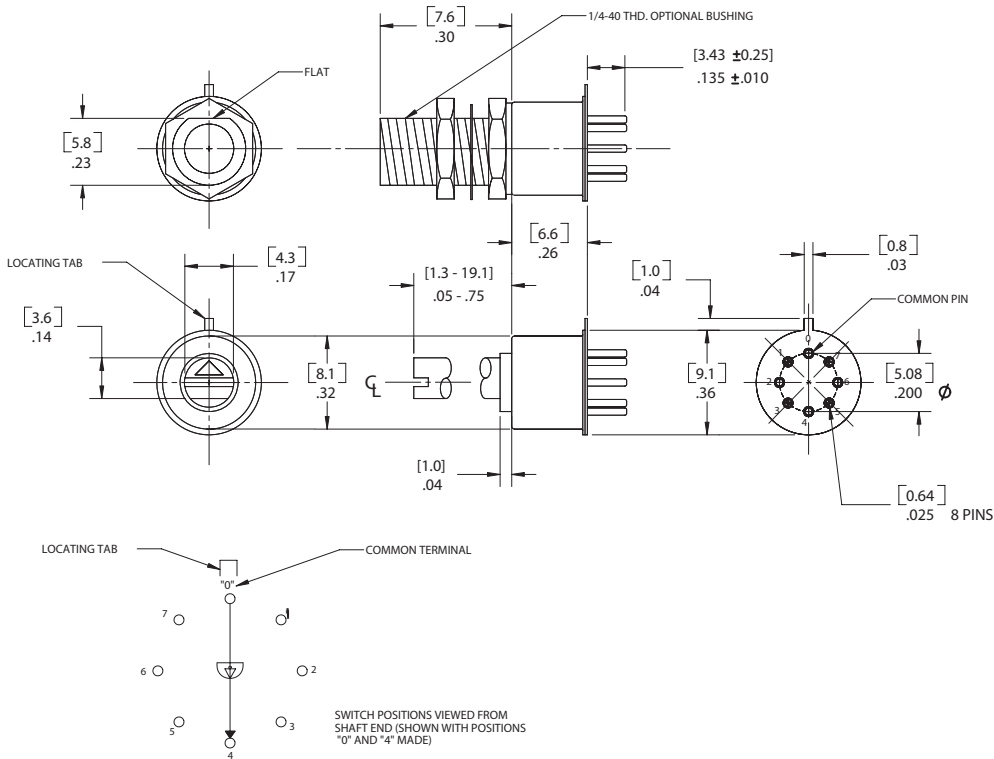

MECHANICAL / ELECTRICAL CHARACTERISTICS:

- Contact rating:**
dry circuit to 500 mA
@ 125 VAC
- Contact material:**
hard gold over barrier
- Contact resistance:**
80 milliohms Max (initially)
- Life:**
10,000 actuations
- End of life criteria:**
100 milliohms
contact resistance
- Angle of throw:**
45° / position—
8 positions max
- Breakdown voltage:**
500 V 60 HZ
- Insulation resistance:**
50,000 megohms
- Actuation torque:**
85 inch—grams nom initially
- Temperature range:**
-30°C to +100°C

030-XOX-9XX

