

0.5mm Pitch

SERIES

6240

0.5mmピッチ RA SMT 下接点 ワンタッチロック 小極

0.5mmPitch RA SMT Bottom contact One-touch lock Low-pin count

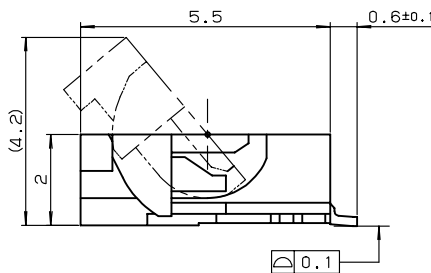
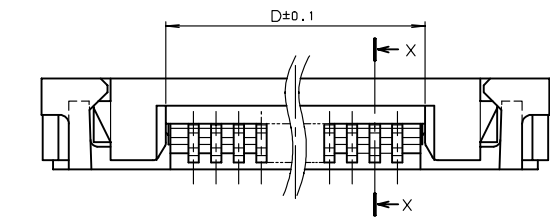
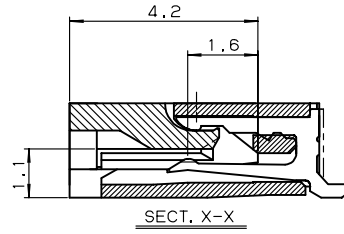
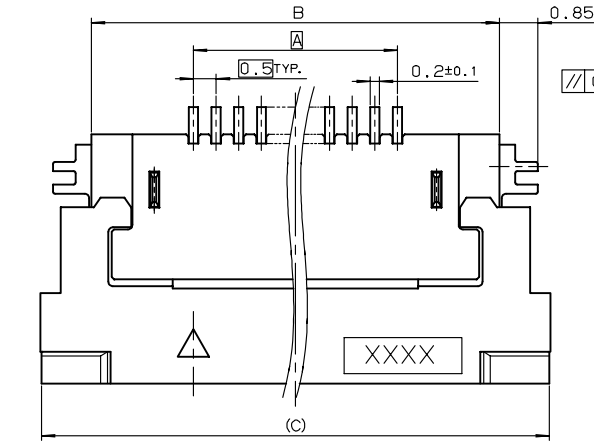

極数 NO. OF POS.	A	B	C	D
5	2.0	6.5	8.7	3.1
6	2.5	7.0	9.2	3.6
7	3.0	7.5	9.7	4.1
8	3.5	8.0	10.2	4.6
9	4.0	8.5	10.7	5.1
10	4.5	9.0	11.2	5.6
11	5.0	9.5	11.7	6.1
12	5.5	10.0	12.2	6.6
13	6.0	10.5	12.7	7.1
14	6.5	11.0	13.2	7.6
15	7.0	11.5	13.7	8.1
16	7.5	12.0	14.2	8.6
17	8.0	12.5	14.7	9.1
18	8.5	13.0	15.2	9.6
19	9.0	13.5	15.7	10.1
20	9.5	14.0	16.2	10.6
21	10.0	14.5	16.7	11.1
22	10.5	15.0	17.2	11.6
23	11.0	15.5	17.7	12.1
24	11.5	16.0	18.2	12.6
25	12.0	16.5	18.7	13.1
26	12.5	17.0	19.2	13.6
27	13.0	17.5	19.7	14.1
28	13.5	18.0	20.2	14.6
29	14.0	18.5	20.7	15.1
30	14.5	19.0	21.2	15.6

生産対応可能極数については、営業部にご確認願います。

Feel free to contact our sales department for available numbers of positions.

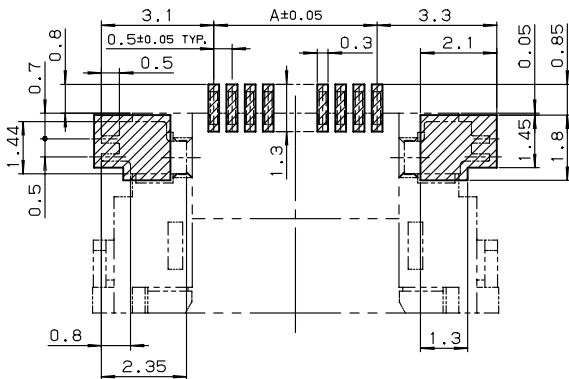

基板取付け方
MOUNTING LAYOUT

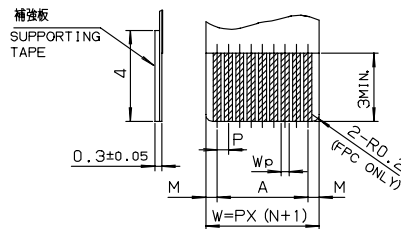

	FPC		FFC	
	1	2	1	2
M	0.5±0.12	0.5±0.1	0.5±0.1	0.5±0.08
P	0.5±0.02	0.5±0.05	0.5±0.03	0.5±0.05
A	A±0.03	A±0.05	A±0.03	A±0.05
W	W±0.07	W±0.07	W±0.07	W±0.07
Wp	0.35 ^{+0.04} _{-0.03}	0.35±0.05	0.3 ^{+0.05} _{-0.02}	0.3 ^{+0.05} _{-0.02}

適用FPC, FFC寸法
APPLICABLE FPC, FFC

注文コード ORDERING CODE

04 6240 OXX 0X6 XXX X

006 800+ : スズ銅めっき Sn-Cu Plated (RoHS対応品 RoHS Compliant Product)

006 800 : スズ鉛めっき Sn-Pb Plated

026 846+ : 金めっき Au Plated (RoHS対応品 RoHS Compliant Product)

極数 NUMBER OF POSITIONS

0.5mm Pitch

SERIES

6240

0.5mmピッチ RA SMT 下接点 ワンタッチロック 中極

0.5mmPitch RA SMT Bottom contact One-touch lock Medium-pin count

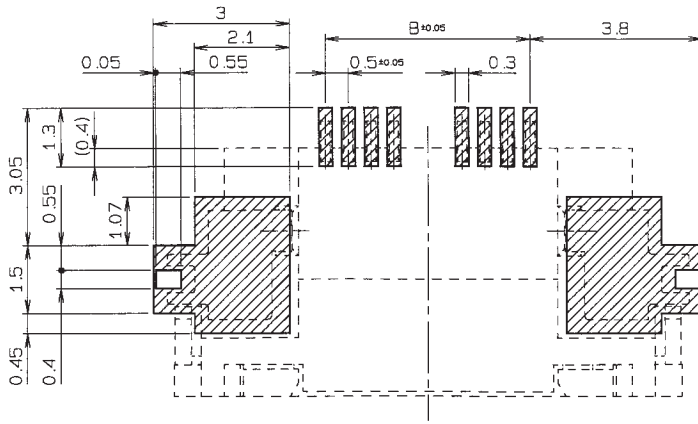
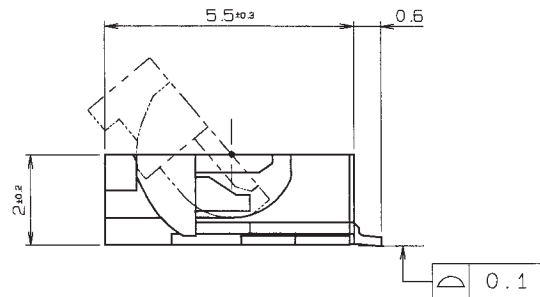
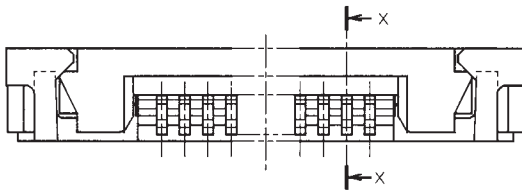
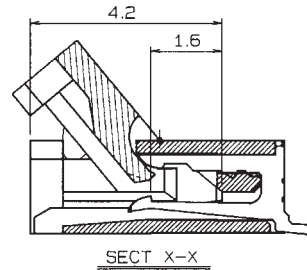
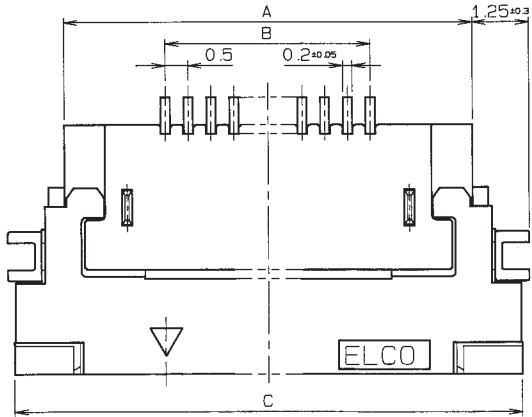

	FPC		FFC	
	1	2	1	2
M	0.5 ^{±0.12}	0.5 ^{±0.1}	0.5 ^{±0.1}	0.5 ^{±0.08}
P	0.5 ^{±0.02}	0.5 ^{±0.05}	0.5 ^{±0.03}	0.5 ^{±0.05}
B	B ^{±0.03}	B ^{±0.05}	B ^{±0.03}	B ^{±0.05}
W	W ^{±0.07}	W ^{±0.07}	W ^{±0.07}	W ^{±0.07}
WD	0.35 ^{+0.04} _{-0.03}	0.35 ^{±0.05}	0.35 ^{±0.05}	0.35 ^{±0.05}

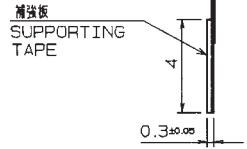

極数 NO. OF POS.	A	B	C
30	19.0	14.5	21.2
31	19.5	15.0	21.7
32	20.0	15.5	22.2
33	20.5	16.0	22.7
34	21.0	16.5	23.2
35	21.5	17.0	23.7
36	22.0	17.5	24.2
37	22.5	18.0	24.7
38	23.0	18.5	25.2
39	23.5	19.0	25.7
40	24.0	19.5	26.2
41	24.5	20.0	26.7
42	25.0	20.5	27.2
43	25.5	21.0	27.7
44	26.0	21.5	28.2
45	26.5	22.0	28.7
46	27.0	22.5	29.2
47	27.5	23.0	29.7
48	28.0	23.5	30.2
49	28.5	24.0	30.7
50	29.0	24.5	31.2

適用FPC, FFC寸法
APPLICABLE FPC, FFC

注文コード ORDERING CODE
04 6240 OXX 0X1 XXX X

- 001 800+ : スズ銅めっき Sn-Cu Plated (RoHS対応品 RoHS Compliant Product)
 - 001 800 : スズ鉛めっき Sn-Pb Plated
 - 021 846+ : 金めっき Au Plated (RoHS対応品 RoHS Compliant Product)
- 極数 NUMBER OF POSITIONS

生産対応可能極数については、営業部にご確認願います。
Feel free to contact our sales department for available numbers of positions.

0.5mm Pitch

SERIES

6240

0.5mmピッチ RA SMT 下接点 ワンタッチロック 大極

0.5mmPitch RA SMT Bottom contact One-touch lock High-pin count

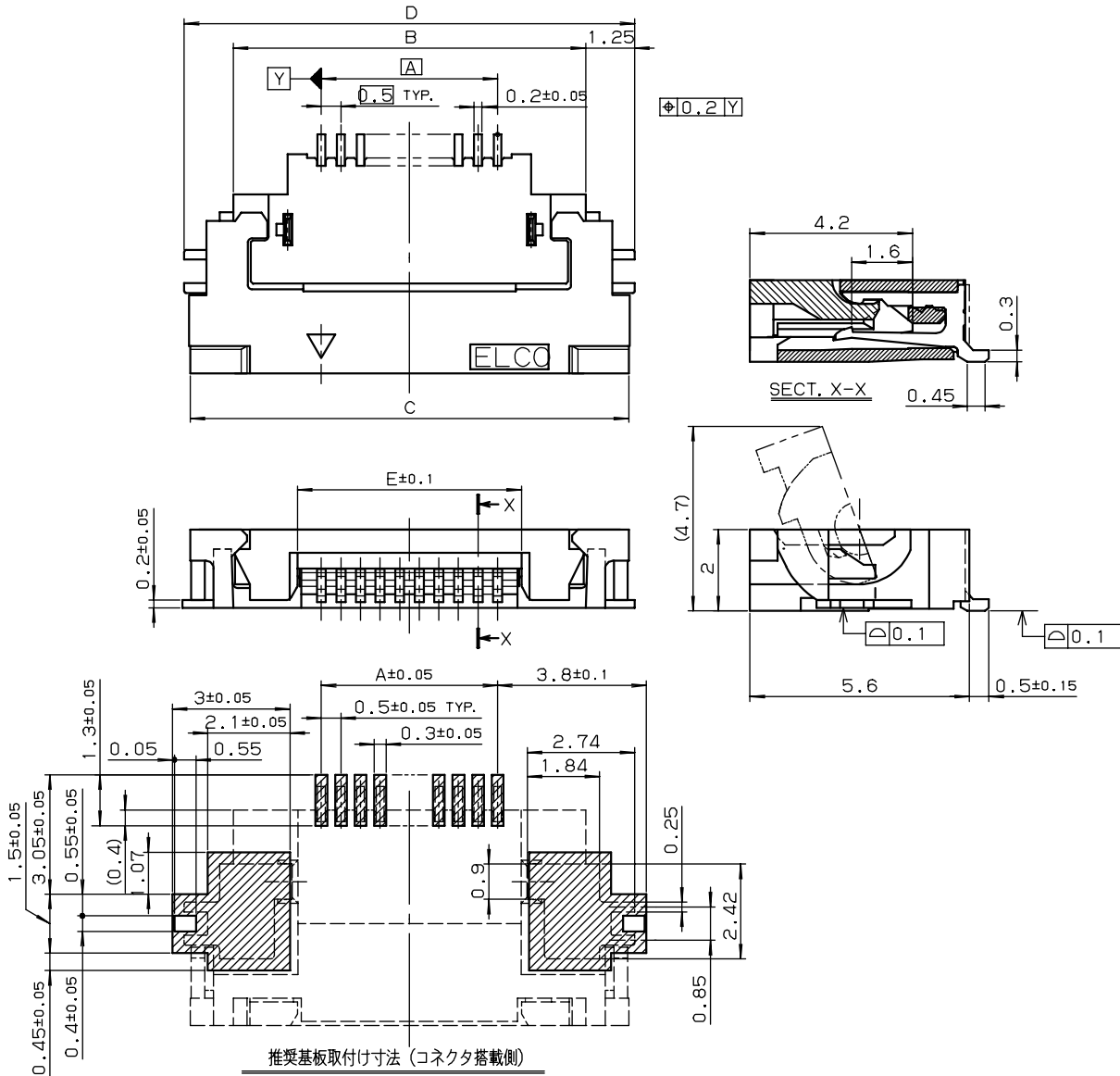

MOUNTING LAYOUT (CONN. MOUNTING SIDE)

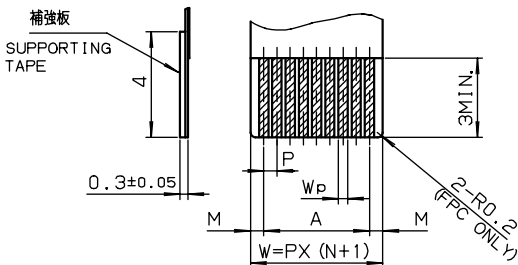

	FPC		FFC	
	1	2	1	2
M	0.5±0.12	0.5±0.1	0.5±0.1	0.5±0.08
P	0.5±0.02	0.5±0.05	0.5±0.03	0.5±0.05
A	A±0.03	A±0.05	A±0.03	A±0.05
W	W±0.07	W±0.07	W±0.07	W±0.07
Wp	0.35 ^{+0.04} _{-0.03}	0.35±0.05	0.3 ^{+0.05} _{-0.02}	0.3 ^{+0.05} _{-0.02}

適用FPC, FFC寸法
APPLICABLE FPC, FFC

極数 NO. OF POS.	寸法 DIMENSION				
	A	B	C	D	E
51	25.0	29.5	31.7	32.0	26.17
52	25.5	30.0	32.2	32.5	26.67
53	26.0	30.5	32.7	33.0	27.17
54	26.5	31.0	33.2	33.5	27.67
55	27.0	31.5	33.7	34.0	28.17
56	27.5	32.0	34.2	34.5	28.67
57	28.0	32.5	34.7	35.0	29.17
58	28.5	33.0	35.2	35.5	29.67
59	29.0	33.5	35.7	36.0	30.17
60	29.5	34.0	36.2	36.5	30.67

注文コード ORDERING CODE
04 6240 OXX 0X5 XXX X

- 005 800+ : スズ銅めっき Sn-Cu Plated (RoHS対応品 RoHS Compliant Product)
- 005 800 : スズ鉛めっき Sn-Pb Plated
- 025 846+ : 金めっき Au Plated (RoHS対応品 RoHS Compliant Product)

極数 NUMBER OF POSITIONS

生産対応可能極数については、営業部にご確認
願います。
Feel free to contact our sales department
for available numbers of positions.

0.5mm Pitch

SERIES

6240

エンボス梱包品
Tape and Reel Package

●5~50 POSITIONS

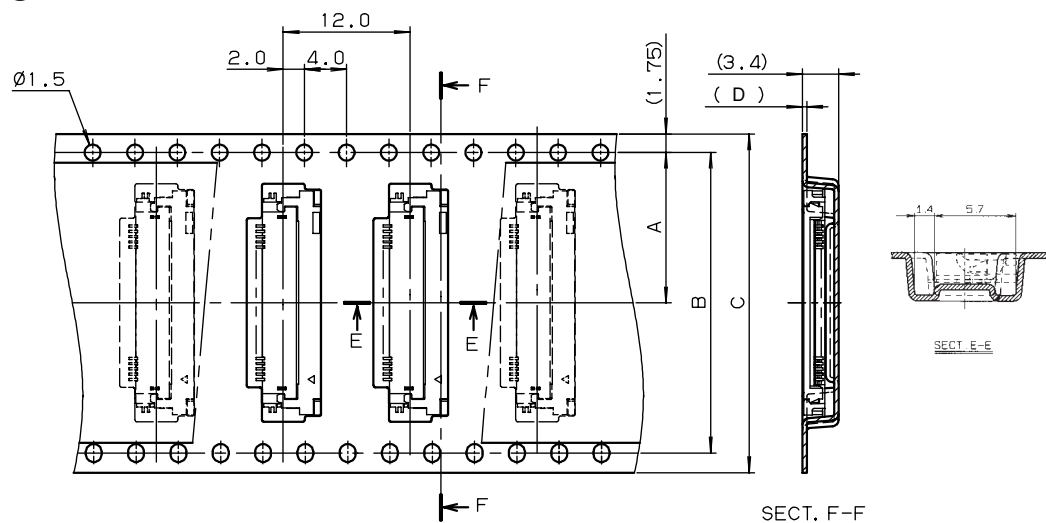

極数 NO. OF POS.	A	B	C	D
5	11.5	---	24	0.4
6	11.5	---	24	0.4
7	11.5	---	24	0.4
8	11.5	---	24	0.4
9	11.5	---	24	0.4
10	11.5	---	24	0.4
11	11.5	---	24	0.4
12	11.5	---	24	0.4
13	11.5	---	24	0.4
14	11.5	---	24	0.4
15	11.5	---	24	0.4
16	11.5	---	24	0.4
17	11.5	---	24	0.4
18	11.5	---	24	0.4
19	11.5	---	24	0.4
20	14.2	28.4	32	0.4
21	14.2	28.4	32	0.4
22	14.2	28.4	32	0.4
23	14.2	28.4	32	0.4
24	14.2	28.4	32	0.4
25	14.2	28.4	32	0.4
26	14.2	28.4	32	0.4
27	14.2	28.4	32	0.4
28	14.2	28.4	32	0.4
29	14.2	28.4	32	0.4
30	14.2	28.4	32	0.4

注文コード ORDERING CODE

04 6240 0XX 0X6 XXX X

- 006 800+ : スズ銅めっき Sn-Cu Plated (RoHS対応品 RoHS Compliant Product)
- 006 800 : スズ鉛めっき Sn-Pb Plated
- 026 846+ : 金めっき Au Plated (RoHS対応品 RoHS Compliant Product)

極数 NUMBER OF POSITIONS

注文コード ORDERING CODE

04 6240 0XX 0X1 XXX X

- 001 800+ : スズ銅めっき Sn-Cu Plated (RoHS対応品 RoHS Compliant Product)
- 001 800 : スズ鉛めっき Sn-Pb Plated
- 021 846+ : 金めっき Au Plated (RoHS対応品 RoHS Compliant Product)

極数 NUMBER OF POSITIONS

極数 NO. OF POS.	A	B	C	D
31	20.2	40.4	44	0.3
32	20.2	40.4	44	0.3
33	20.2	40.4	44	0.3
34	20.2	40.4	44	0.3
35	20.2	40.4	44	0.3
36	20.2	40.4	44	0.3
37	20.2	40.4	44	0.3
38	20.2	40.4	44	0.3
39	20.2	40.4	44	0.3
40	20.2	40.4	44	0.3
41	20.2	40.4	44	0.3
42	20.2	40.4	44	0.3
43	20.2	40.4	44	0.3
44	20.2	40.4	44	0.3
45	20.2	40.4	44	0.3
46	20.2	40.4	44	0.3
47	20.2	40.4	44	0.3
48	20.2	40.4	44	0.3
49	20.2	40.4	44	0.3
50	20.2	40.4	44	0.3

●51~60 POSITIONS

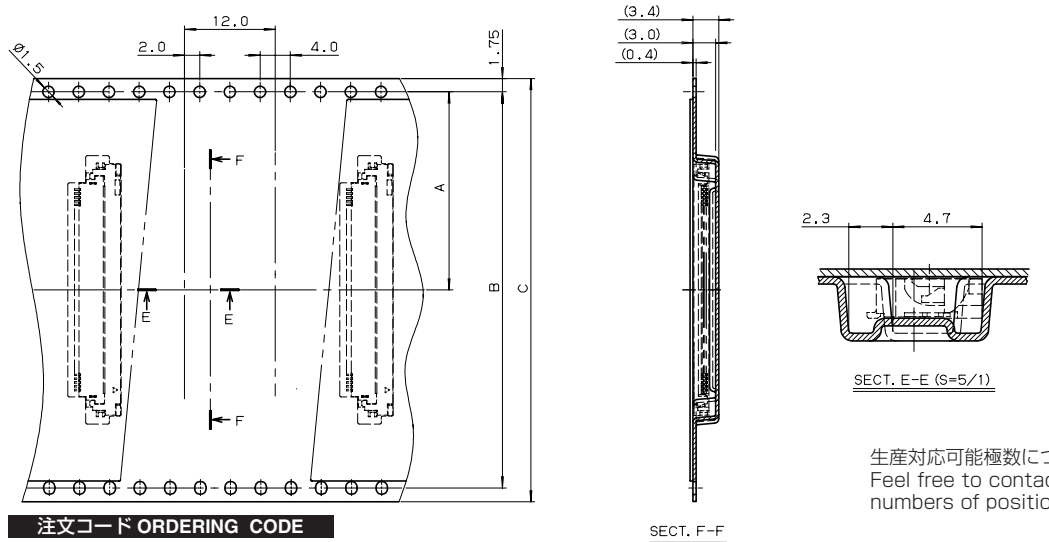

極数 NO. OF POS.	A	B	C
51	26.5	52.4	56.0
52	26.5	52.4	56.0
53	26.5	52.4	56.0
54	26.5	52.4	56.0
55	26.5	52.4	56.0
56	26.5	52.4	56.0
57	26.5	52.4	56.0
58	26.5	52.4	56.0
59	26.5	52.4	56.0
60	26.5	52.4	56.0

注文コード ORDERING CODE

04 6240 0XX 0X5 XXX X

- 005 800+ : スズ銅めっき Sn-Cu Plated (RoHS対応品 RoHS Compliant Product)
- 005 800 : スズ鉛めっき Sn-Pb Plated
- 025 846+ : 金めっき Au Plated (RoHS対応品 RoHS Compliant Product)

極数 NUMBER OF POSITIONS

生産対応可能極数については、営業部にご確認願います。
Feel free to contact our sales department for available numbers of positions.

梱包数量 2000個/リール
PACKING QUANTITY : 2000/Reel