

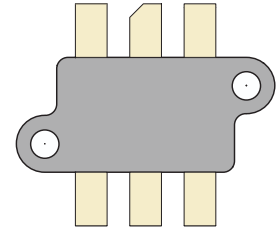

**RF POWER MOSFET  
 N-CHANNEL ENHANCEMENT MODE**

The ARF300 is a N-CHANNEL RF power transistor in a high efficiency flangeless package. It is designed for high voltage operation in narrow band ISM and MRI power amplifiers at frequencies up to 45MHz. The transistor is well matched to the ARF301 P-CHANNEL RF power transistor making the pair well suited for bridge configurations

- Specified 125 Volt, 27 MHz Characteristics:
  - Output Power = 300 Watts.
  - Gain = 15dB (Class E)
  - Efficiency = 80%
- RoHS Compliant 
- High Performance
- High Voltage Breakdown and Large SOA for Superior Ruggedness
- Low Thermal Resistance.
- Capacitance matched with ARF301 P-Channel

**Maximum Ratings**
**All Ratings:  $T_c = 25^\circ\text{C}$  unless otherwise specified**

Symbol	Parameter	Ratings	Unit
$V_{DSS}$	Drain-Source Voltage	500	V
$V_{DGO}$	Drain-Gate Voltage	500	
$I_D$	Continuous Drain Current @ $T_c = 25^\circ\text{C}$	24	A
$V_{GS}$	Gate-Source Voltage	$\pm 30$	V
$P_D$	Total Power Dissipation @ $T_c = 25^\circ\text{C}$	1000	W
$T_J, T_{STG}$	Operating and Storage Junction Temperature Range	-55 to 175	$^\circ\text{C}$
$T_L$	Lead Temperature: 0.063" from Case for 10 Sec.	300	

**Static Electrical Characteristics**

Symbol	Parameter	Min	Typ	Max	Unit
$BV_{DSS}$	Drain-Source Breakdown Voltage ( $V_{GS} = 0V, I_D = 250 \mu\text{A}$ )	500			V
$V_{DS(ON)}$	On State Drain Voltage <sup>1</sup> ( $I_{D(ON)} = 12A, V_{GS} = 10V$ )		3	4	
$I_{DSS}$	Zero Gate Voltage Drain Current ( $V_{DS} = V_{DSS}, V_{GS} = 0V$ )			25	$\mu\text{A}$
	Zero Gate Voltage Drain Current ( $V_{DS} = 50V_{DSS}, V_{GS} = 0, T_c = 125^\circ\text{C}$ )			250	
$I_{GSS}$	Gate-Source Leakage Current ( $V_{DS} = \pm 30V, V_{GS} = 0V$ )			$\pm 100$	nA
$g_{fs}$	Forward Transconductance ( $V_{DS} = 15V, I_D = 12A$ )	5	8		mhos
$V_{GS(TH)}$	Gate Threshold Voltage ( $V_{DS} = V_{GS}, I_D = 10mA$ )	2.5	4	5	Volts

**Thermal Characteristics**

Symbol	Parameter	Min	Typ	Max	Unit
$R_{\theta JC}$	Junction to Case			0.15	$^\circ\text{C}/\text{W}$
$R_{\theta JHS}$	Junction to Sink (High Efficiency Thermal Joint Compound and Planar Heat Sink Surface.)			0.27	

 **CAUTION:** These Devices are Sensitive to Electrostatic Discharge. Proper Handling Procedures Should Be Followed.

Microsemi Website - <http://www.microsemi.com>

## Dynamic Characteristics

ARF300

Symbol	Parameter	Test Conditions	Min	Typ	Max	Unit
$C_{ISS}$	Input Capacitance	$V_{GS} = 0V$		1890	2100	pF
$C_{OSS}$	Output Capacitance	$V_{DS} = 50V$		350	390	
$C_{RSS}$	Reverse Transfer Capacitance	$f = 1MHz$		75	90	

## Functional Characteristics

Symbol	Characteristic	Test Conditions	Min	Typ	Max	Unit
$G_{PS}$	Common Source Amplifier Power Gain	$f = 27MHz$	15	17		dB
$\eta$	Drain Efficiency	$I_{dq} = 0mA$ $V_{DD} = 125V$	80	85		%
$\Psi$	Electrical Ruggedness VSWR 10:1	$P_{OUT} = 300W$	No Damage			

1. Pulse Test: Pulse width < 380  $\mu$ S, Duty Cycle < 2%.

Microsemi reserves the right to change, without notice, the specifications and information contained herein.

## Dynamic Characteristics

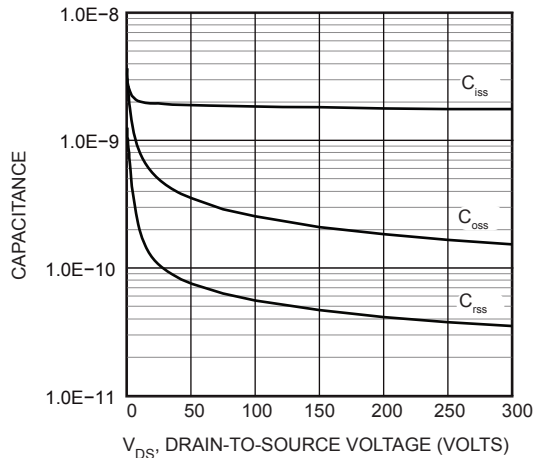

Figure 1, Typical Capacitance vs. Drain-to-Source Voltage

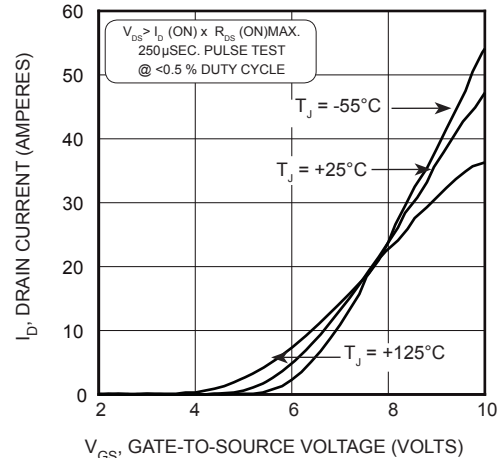

Figure 2, Typical Transfer Characteristics

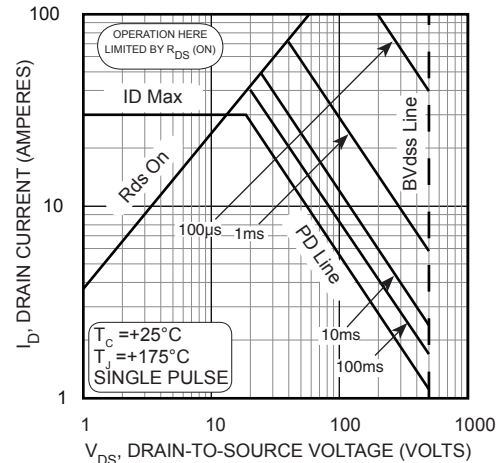

Figure 3, Typical Maximum Safe Operating Area

# Dynamic Characteristics

ARF300

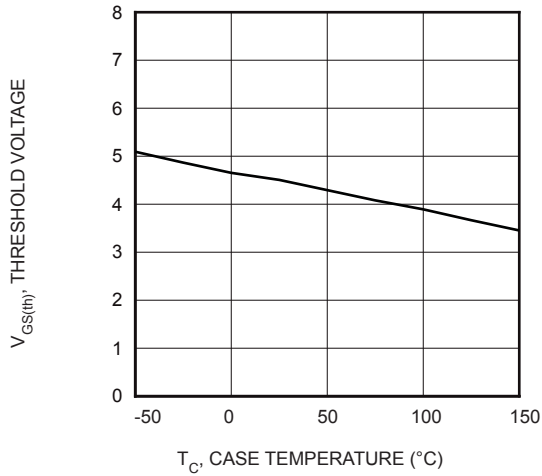

Figure 4, Typical Threshold Voltage vs Temperature

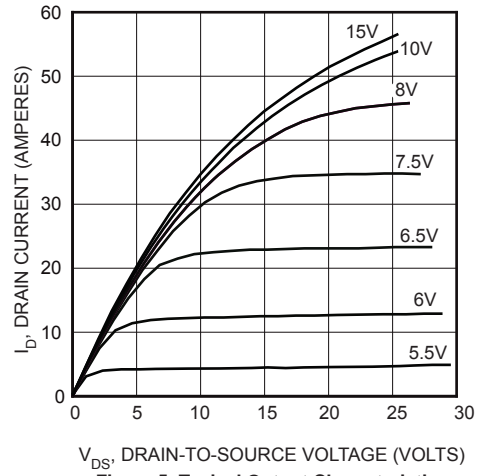

Figure 5, Typical Output Characteristics

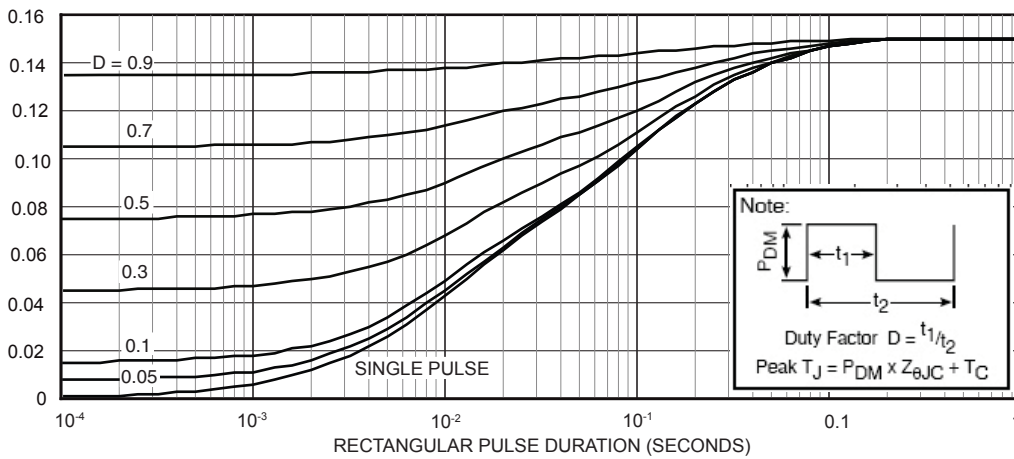

FIGURE 6a, MAXIMUM EFFECTIVE TRANSIENT THERMAL IMPEDANCE, JUNCTION-TO-CASE vs PULSE DURATION

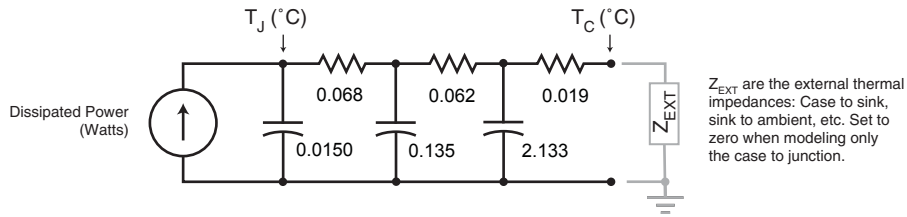

Figure 6b, TRANSIENT THERMAL IMPEDANCE MODEL

Table 1 - Typical Class AB Large Signal Input - Output Impedance

Freq. (MHz)	Z <sub>in</sub> (Ω)	Z <sub>OL</sub> (Ω)
2.0	18 - j 10.5	21 - j 1.4
13.56	2.66 - j 4.6	17.5 - j 7.8
27.12	1.79 - j 1.6	11.7 - j 10.4
40.68	1.68 - j 0.14	7.7 - j 10

Z<sub>IN</sub> - Gate shunted with 25Ω I<sub>dd</sub> = 0  
 Z<sub>OL</sub> - Conjugate of optimum load for 300 Watts output at V<sub>dd</sub>=125V

## Class CE 27.12 MHz amplifier

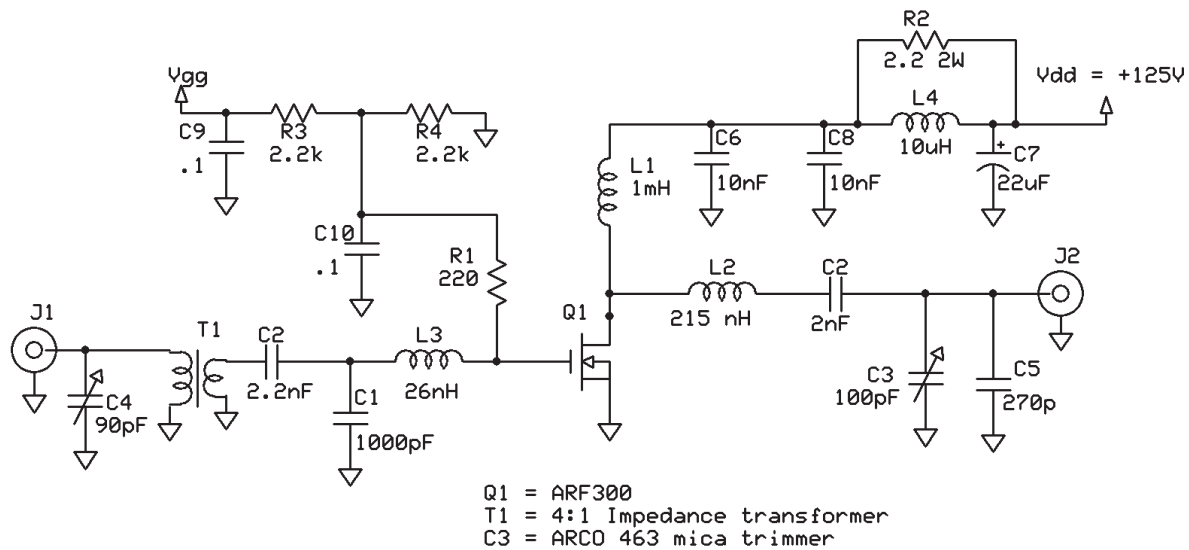

## T11 Package Outline

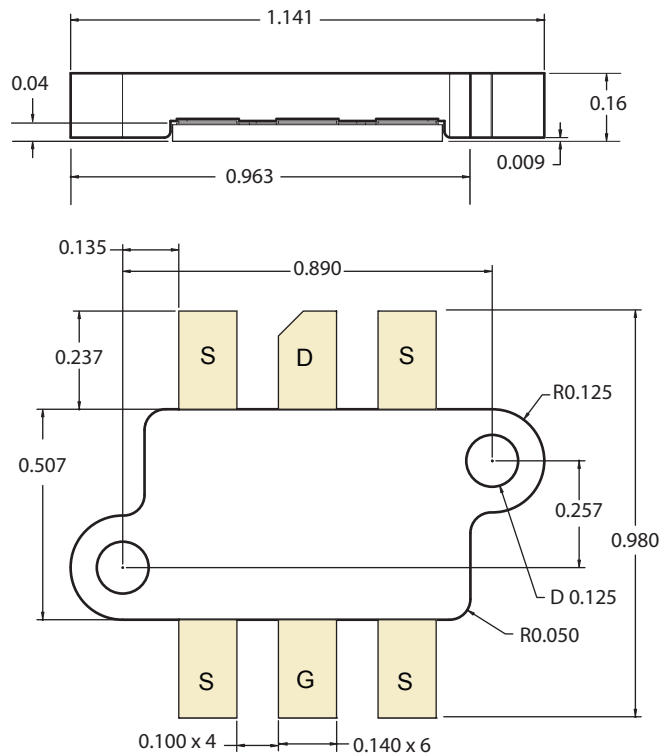

Use 4-40 (M3) screws for mounting.  
 Torque = 4-6 in-lb (0.45- 0.7 Nm).



**ATTENTION:** This is a high power device. Special considerations must be followed in mounting to ensure proper operation of these devices. Incorrect mounting can cause internal temperatures to exceed the maximum allowable operating junction temperature. Refer to Microsemi Application Note #1810 before starting system design. <http://www.microsemi.com/support/micnotes/1810.pdf>