

**FEATURES**

- \* 0.52 inch (13.2 mm) DIGIT HEIGHT.
- \* CONTINUOUS UNIFORM SEGMENTS.
- \* LOW POWER REQUIREMENT.
- \* EXCELLENT CHARACTERS APPEARANCE.
- \* HIGH BRIGHTNESS & HIGH CONTRAST.
- \* WIDE VIEWING ANGLE.
- \* SOLID STATE RELIABILITY.
- \* CATEGORIZED FOR LUMINOUS INTENSITY.

**DESCRIPTION**

The LTC-5836HR is a 0.52 inch (13.2 mm) digit height triple digit seven-segment display. This device utilizes High Efficiency Red LED chips, which are made from GaAsP on GaP substrate, and has a red face and red segments.

**DEVICE**

<b>PART NO.</b>	<b>DESCRIPTION</b>
Hi-Eff. Red	Common Anode
LTC-5836HR	Rt. Hand Decimal

## PACKAGE DIMENSIONS

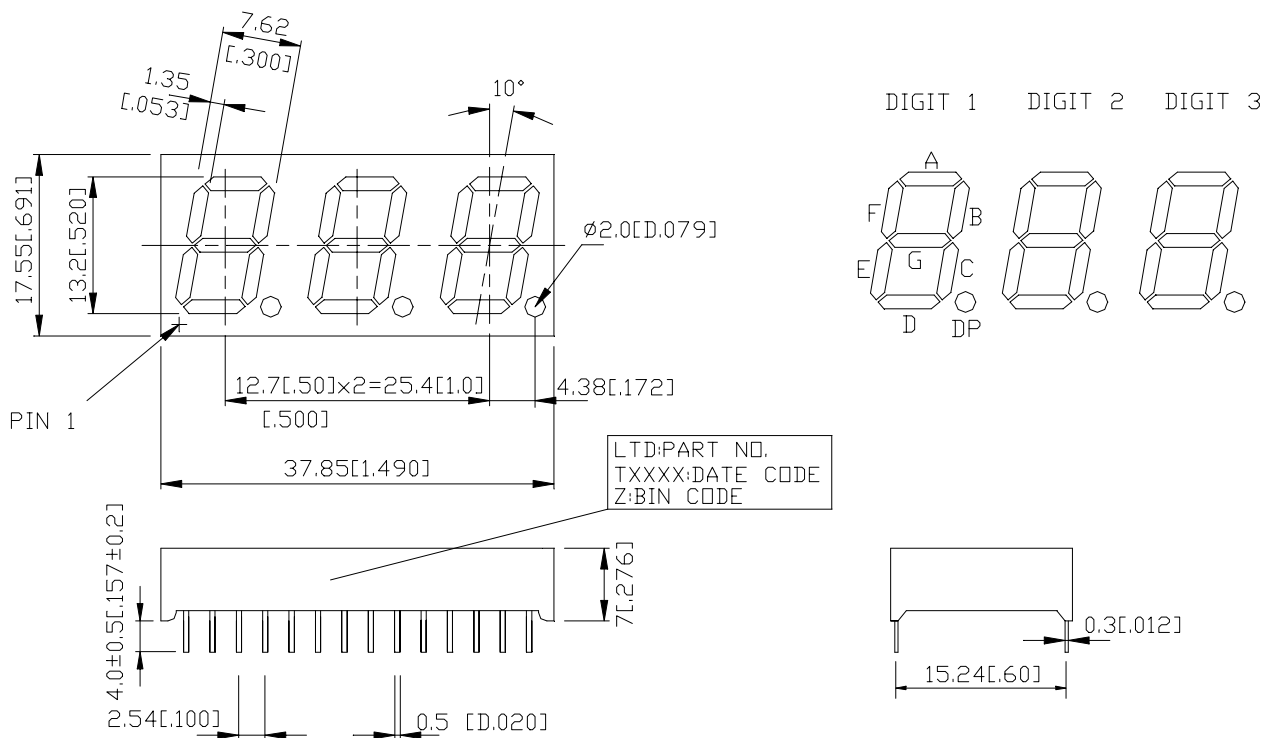

NOTES: All dimensions are in millimeters. Tolerances are  $\pm 0.25$  mm (0.01") unless otherwise noted.

## INTERNAL CIRCUIT DIAGRAM

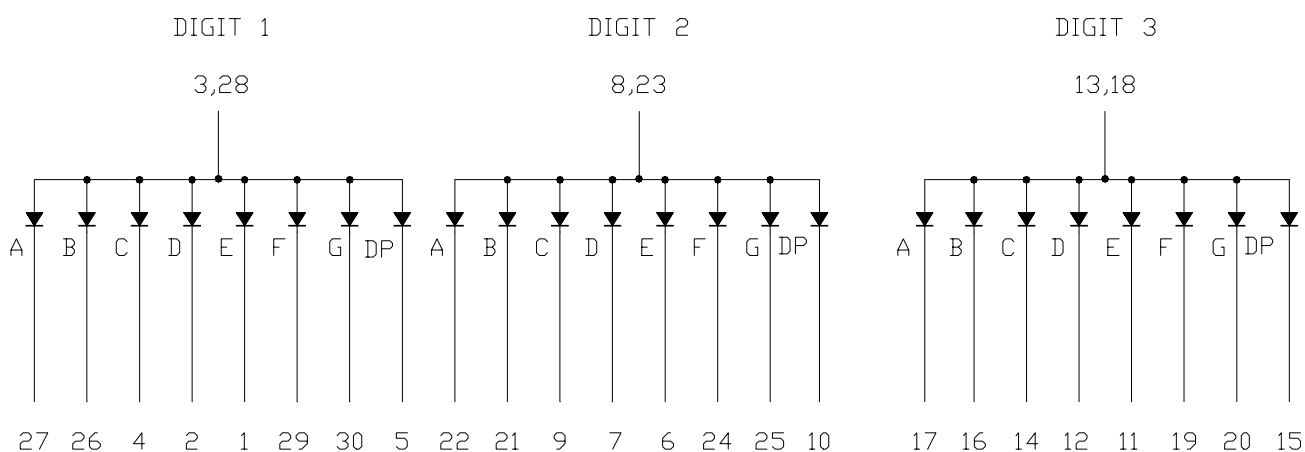

**PIN CONNECTION**

<b>NO.</b>	<b>CONNECTION</b>	<b>NO.</b>	<b>CONNECTION</b>
1	CATHODE E (DIGIT 1)	16	CATHODE B (DIGIT 3)
2	CATHODE D (DIGIT 1)	17	CATHODE A (DIGIT 3)
3	COMMON ANODE (DIGIT 1)	18	COMMON ANODE (DIGIT 3)
4	CATHODE C (DIGIT 1)	19	CATHODE F (DIGIT 3)
5	CATHODE D.P. (DIGIT 1)	20	CATHODE G (DIGIT 3)
6	CATHODE E (DIGIT 2)	21	CATHODE B (DIGIT 2)
7	CATHODE D (DIGIT 2)	22	CATHODE A (DIGIT 2)
8	COMMON ANODE (DIGIT 2)	23	COMMON ANODE (DIGIT 2)
9	CATHODE C (DIGIT 2)	24	CATHODE F (DIGIT 2)
10	CATHODE D.P. (DIGIT 2)	25	CATHODE G (DIGIT 2)
11	CATHODE E (DIGIT 3)	26	CATHODE B (DIGIT 1)
12	CATHODE D (DIGIT 3)	27	CATHODE A (DIGIT 1)
13	COMMON ANODE (DIGIT 3)	28	COMMON ANODE (DIGIT 1)
14	CATHODE C (DIGIT 3)	29	CATHODE F (DIGIT 1)
15	CATHODE D.P. (DIGIT 3)	30	CATHODE G (DIGIT 1)

**ABSOLUTE MAXIMUM RATING AT Ta=25°C**

PARAMETER	MAXIMUM RATING	UNIT
Power Dissipation Per Segment	75	mW
Peak Forward Current Per Segment ( 1/10 Duty Cycle, 0.1ms Pulse Width )	100	mA
Continuous Forward Current Per Segment Derating Linear From 25°C Per Segment	25 0.33	mA mA/°C
Reverse Voltage Per Segment	5	V
Operating Temperature Range	-35°C to +85°C	
Storage Temperature Range	-35°C to +85°C	
Solder Temperature: max 260°C for max 3sec at 1.6mm below seating plane.		

**ELECTRICAL / OPTICAL CHARACTERISTICS AT Ta=25°C**

PARAMETER	SYMBOL	MIN.	TYP.	MAX.	UNIT	TEST CONDITION
Average Luminous Intensity	I <sub>v</sub>	800	2200		μcd	I <sub>F</sub> =10mA
Peak Emission Wavelength	λ <sub>p</sub>		635		nm	I <sub>F</sub> =20mA
Spectral Line Half-Width	Δλ		40		nm	I <sub>F</sub> =20mA
Dominant Wavelength	λ <sub>d</sub>		623		nm	I <sub>F</sub> =20mA
Forward Voltage Per Segment	V <sub>F</sub>		2.0	2.6	V	I <sub>F</sub> =20mA
Reverse Current Per Segment	I <sub>R</sub>			100	μA	V <sub>R</sub> =5V
Luminous Intensity Matching Ratio	I <sub>v</sub> -m			2:1		I <sub>F</sub> =10mA

Note: Luminous intensity is measured with a light sensor and filter combination that approximates the CIE (Commision Internationale De L'Eclairage) eye-response curve.

## TYPICAL ELECTRICAL / OPTICAL CHARACTERISTIC CURVES

(25°C Ambient Temperature Unless Otherwise Noted)

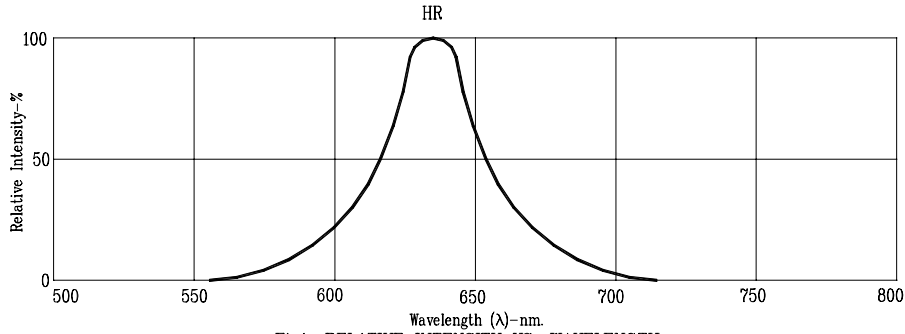

Fig1. RELATIVE INTENSITY VS. WAVELENGTH

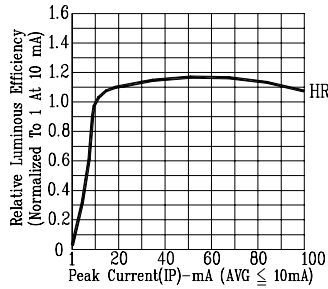

Fig2. RELATIVE LUMINOUS EFFICIENCY (LUMINOUS INTENSITY PER UNIT CURRENT) VS. PEAK CURRENT (REFRESH RATE 1KHz)

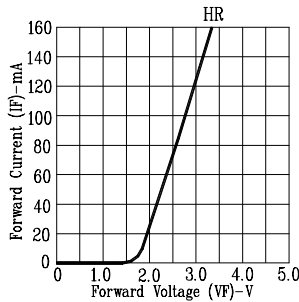

Fig3. FORWARD CURRENT VS. FORWARD VOLTAGE

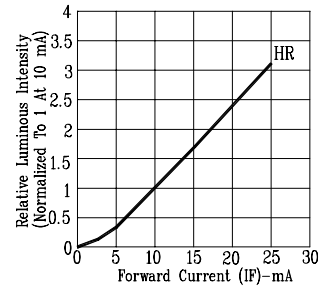

Fig4. RELATIVE LUMINOUS INTENSITY VS. FORWARD CURRENT

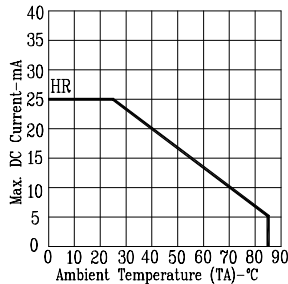

Fig5. MAX. ALLOWABLE DC CURRENT VS. AMBIENT TEMPERATURE.

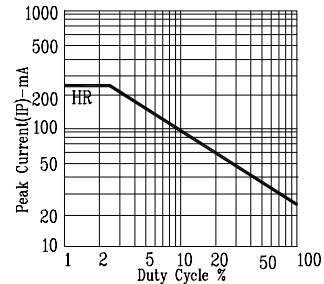

Fig6. MAX. PEAK CURRENT VS. DUTY CYCLE % (REFRESH RATE 1KHz)

NOTE: HR=HI-EFF.RED