

Features

- Thin Form Factor – 170 µm Thick
- Capacity Options up to 1 mAh
- All Solid-State Construction
- High Discharge Rate Capability
- Ultra-Low Self-Discharge Rate
- Industry-Leading Cycle Life
- Fast Recharge
- RoHS Compatible
- Eco-Friendly/Safe



[actual size]

Applications

- Energy Harvesting Solutions/Self-Powered Systems
- Remote/Autonomously Powered Wireless Sensors
- Memory & Real Time Clock (RTC) Backup
- Semi-Active RFID Tags
- Smart Cards (Including Units with Displays/Biometrics)
- Medical Devices
- High Temperature Applications
- Military/DoD & Aerospace

Physical Properties

Size:	25.4 mm x 25.4 mm x 0.170 mm [1.0 in x 1.0 in x 0.007 in]
Mass:	490 mg

General Description

The THINERGY® MEC201 is a solid-state, flexible, rechargeable, thin-film Micro-Energy Cell (MEC). This unique device substantially outperforms all other small form factor electrochemical energy storage technologies, including supercapacitors, printed batteries, and other thin-film batteries. The device is fabricated on a metal foil substrate to achieve its flexibility, thin profile, broad operating temperature range, and long life.

The MEC is offered in a unique, patented package design that maximizes the active area of the cell and minimizes the device footprint to deliver the highest energy and power density of any energy storage element of its size. External terminals in the form of positive and negative nickel-plated tabs are located along the top edge of the cell for easy soldering to printed circuit boards (PCBs). The tabs are supported with a flex circuit for added strength and to keep them planar with the rigid or flex PCBs. Through-holes

Benefits

- Lowest Cost of Ownership
 - No maintenance costs
 - Lasts the lifetime of the application
 - Can be recharged and reused over and over
- Ideal energy storage solution for energy harvesting
 - Can be trickle-charged with no memory effect
- Simple constant-voltage recharge with no current limiting required.

located in the terminal contacts allow the MECs to be aligned on solder posts for easy connection and cell stacking to create battery modules with higher capacity and current. These tabs also allow easy connection to both terminals from either side of the cell, which is important during automated assembly onto flex circuits and PCBs. The conductive metal tabs allow various connection methods including epoxies, anisotropic conductive film (ACF) materials, and solder. The cells can be oriented to stack in series (to multiply voltage) or in parallel (to multiply capacity and power).

The active materials in the device include a Lithium Cobalt Oxide (LiCoO₂) cathode and a Li-metal anode. A solid-state electrolyte called LiPON (Lithium Phosphorus Oxynitride), with its high Li-ion conductivity, is used to provide superior power performance. The extremely low electron conductivity within LiPON results in ultra-low self discharge, making

this technology ideal for applications where energy must be reliably stored for many years without the ability to recharge, or for low-power ambient energy harvesting charging solutions. In addition, this eco-friendly technology contains no toxic chemicals or heavy metals, providing industry-leading safety with absolutely no possibility for chemical leakage, thermal runaway or fire, as experienced with other Li-ion batteries using liquid or gel electrolytes. A proprietary flex-circuit encapsulation methodology is used to achieve the ultra-thin and flexible form factor and to ensure reliability and performance under harsh environmental conditions, far exceeding other micro-energy storage technologies.

The thin form factor, rechargeability, and high discharge rate capability enable applications where conventional coin/button or primary thin batteries are not well suited. Due to its low internal cell resistance, the MEC offers superior charge acceptance, making it an ideal energy storage device for applications where extremely low current recharge sources are available, including various ambient energy harvesting methods. Pulsed or continuous currents as low as 1 μA can be used to effectively recharge this device. The MEC recharges in seconds to minutes, depending on its state of discharge and available charge current. MECs can be recharged using constant current, constant voltage, pulsed current, or pulsed voltage sources. Any charge voltage greater than cell voltage (not to exceed the maximum specified recharge voltage) will result in charging. A variety of charging methods can be used, such as direct connection to a power supply, wireless recharge via inductive coupling, or energy scavenging solutions that harvest kinetic, solar, RF, magnetic, or thermal energy.

The low self-discharge rate results in decades of shelf life. With its recharge cycle stability, the device offers tens of thousands of recharge cycles for many years of use with no memory effects. The MEC201 provides an extremely safe, reliable, and low-cost energy storage solution that outperforms any other micro-battery or capacitor solution. This component class device is intended to be designed in for the life of the product.

Specifications

Parameter	Options ⁽¹⁾	Rating			Conditions
		Min	Typ	Max	
Capacity ⁽²⁾	-7	0.7 mAh			C/2 Discharge Rate @ 25°C
	-10	1.0 mAh			
Stored Energy ⁽²⁾	-7	10J			
	-10	14J			
Operating Temperature	All	-40°C		+85°C	(Note 3)
Storage Temperature	All	-40°C		+50°C	
Charge Time:					
to 80% State of Charge	S		15 Min		4.10V constant voltage recharge (min. peak available current of 10 mA)
	P		10 Min		
to 90% State of Charge	S		20 Min		
	P		15 Min		
Max. Continuous Discharge Current (Standard vs. Performance Grade)	S		30 mA		≥25°C
	P		40 mA		
Internal Resistance	S		50Ω	60Ω	25°C
	P		35Ω	45Ω	
Cycle Life	-7		100,000		10% depth of discharge with typical application load ⁽⁴⁾
			10,000		100% depth of discharge with typical application load ⁽⁴⁾
	-10		100,000		10% depth of discharge with typical application load ⁽⁴⁾
			5,000		100% depth of discharge with typical application load ⁽⁴⁾
Nominal Output Voltage			3.9V		C/2 rate
Recharge			4.10V	4.15V	Constant voltage
Shelf Life			15 years		25°C
Discharge Cutoff Voltage ⁽⁵⁾		2.1V			For currents of 1 mA up to maximum discharge rate
		3.0V			For currents < 1 mA
Annual Non-reversible Capacity Loss ⁽⁶⁾			1%, 3%, 6%		25°C, 45°C, and 65°C respectively
Annual Self-Discharge Rate (Charge Loss) ⁽⁶⁾			1%, 3%, 6%		25°C, 45°C, and 65°C respectively

Notes:

1. See [Ordering Information](#).
2. MECs may be shipped in a partially-charged state. Full charging prior to use is recommended.
3. Standard electrochemical degradation is proportional to temperature increase. Contact IPS for performance information regarding higher temperature applications up to 150°C.
4. 80% of rated capacity remaining @ 25°C.
5. Discharging the cell below the specified discharge cutoff voltage will cause permanent battery damage.
6. After first year.
7. MECs cannot be used in reflow or infrared soldering processes. Hand or robotic soldering is required.

Typical Characteristics

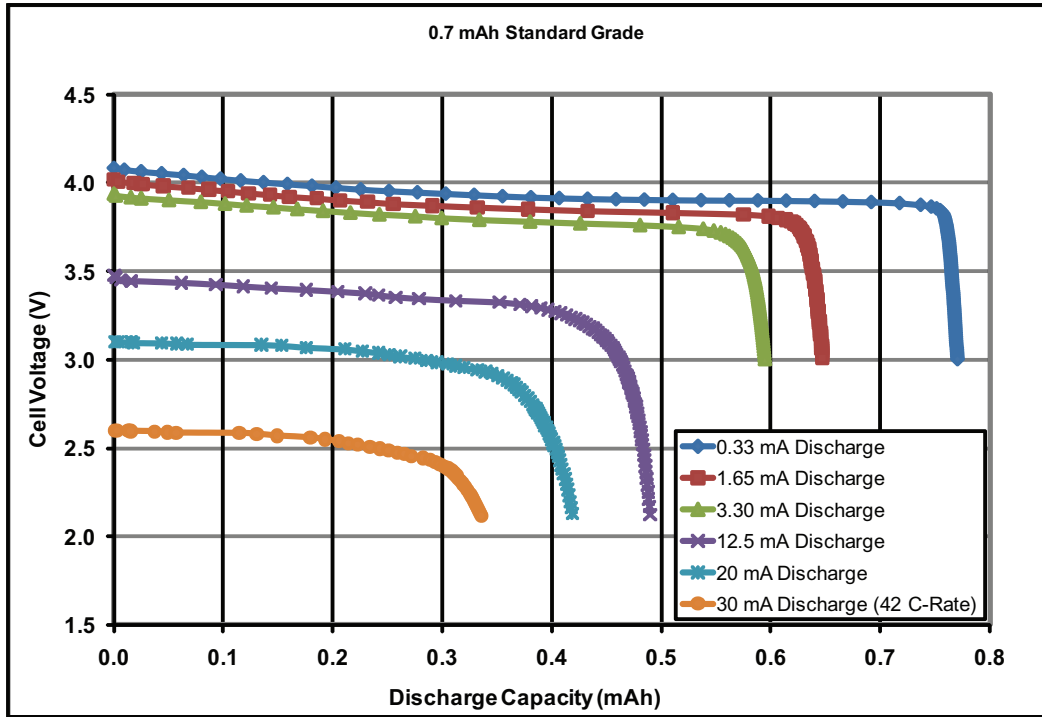

Figure 1: Typical Discharge Curves @25°C (0.7 mAh Standard Grade Cell)

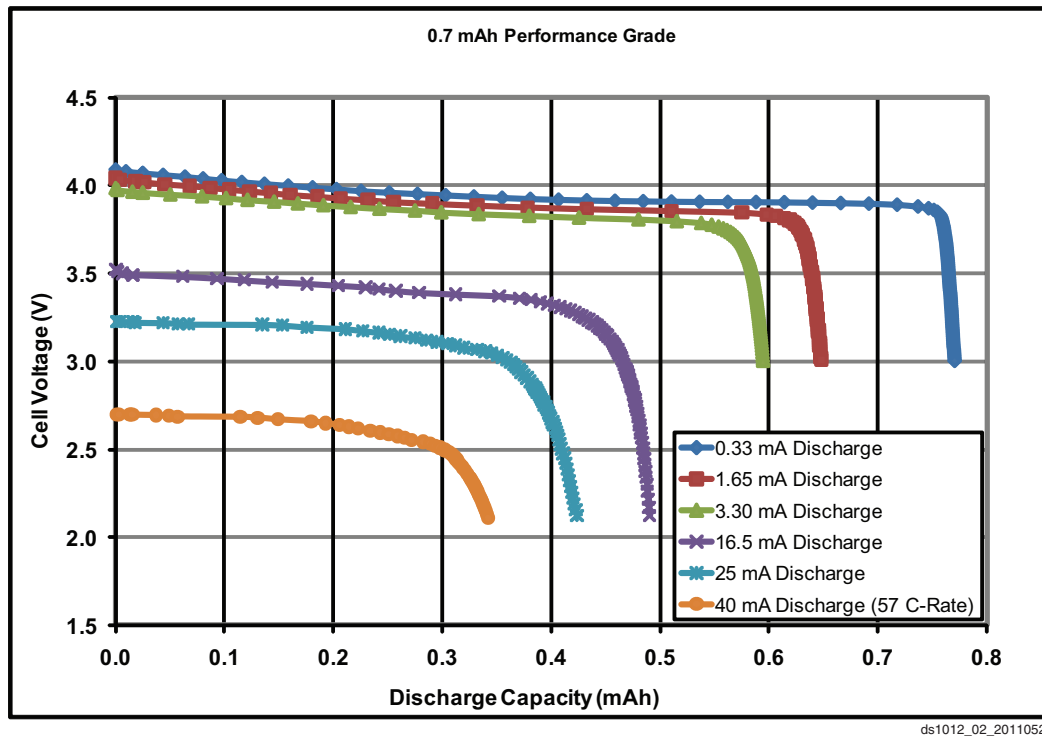
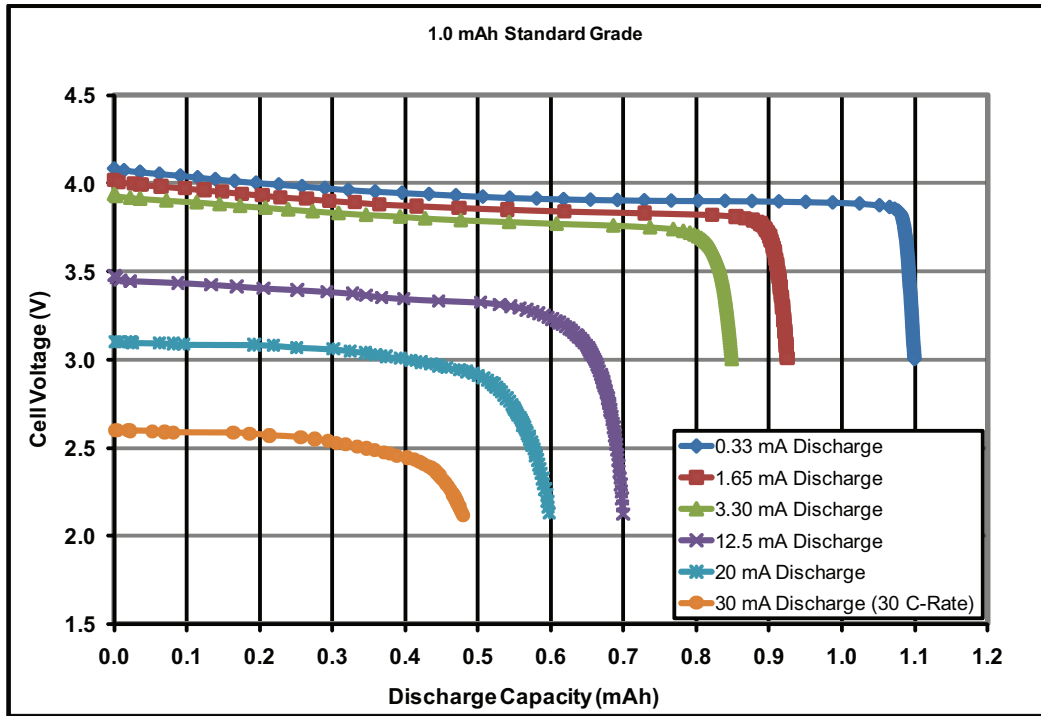
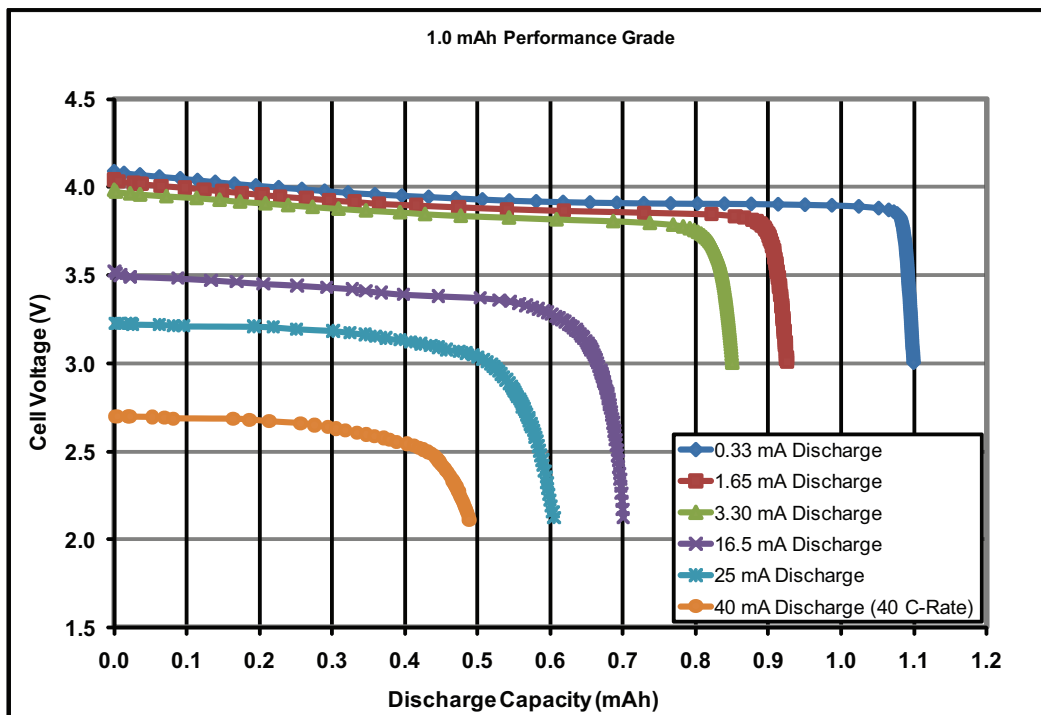

Figure 2: Typical Discharge Curves @25°C (0.7 mAh Performance Grade Cell)



ds1012_03_20110527

Figure 3: Typical Discharge Curves @25°C (1.0 mAh Standard Grade Cell)



ds1012_04_20110527

Figure 4: Typical Discharge Curves @25°C (1.0 mAh Performance Grade Cell)

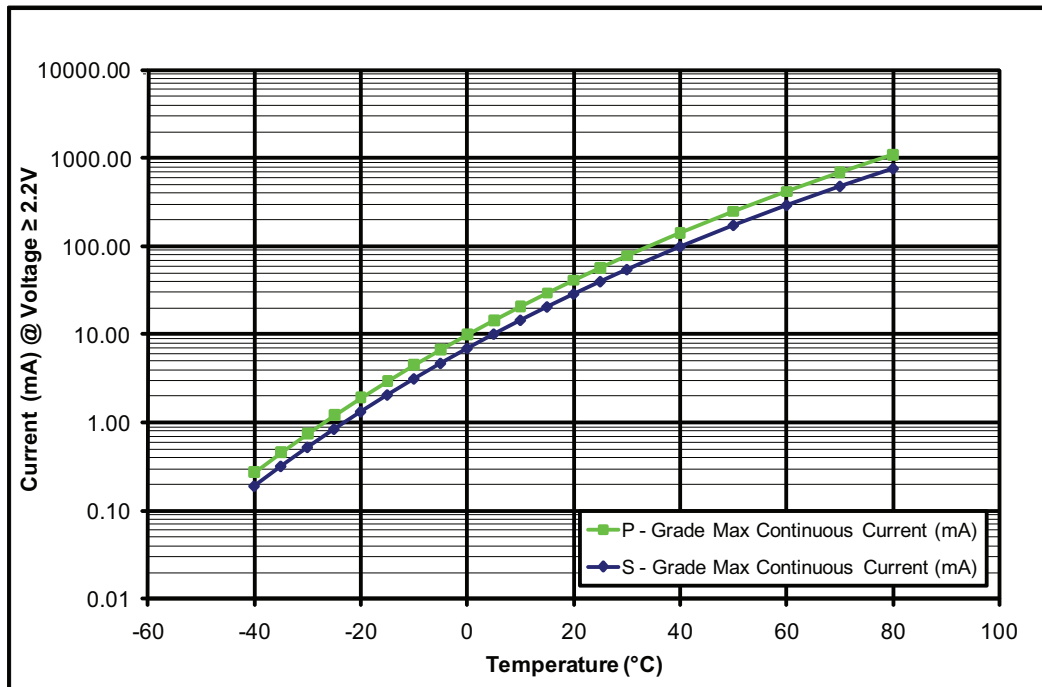

ds1012_05_20110804

Figure 5: Typical Maximum Current vs. Temperature — All Capacity Options

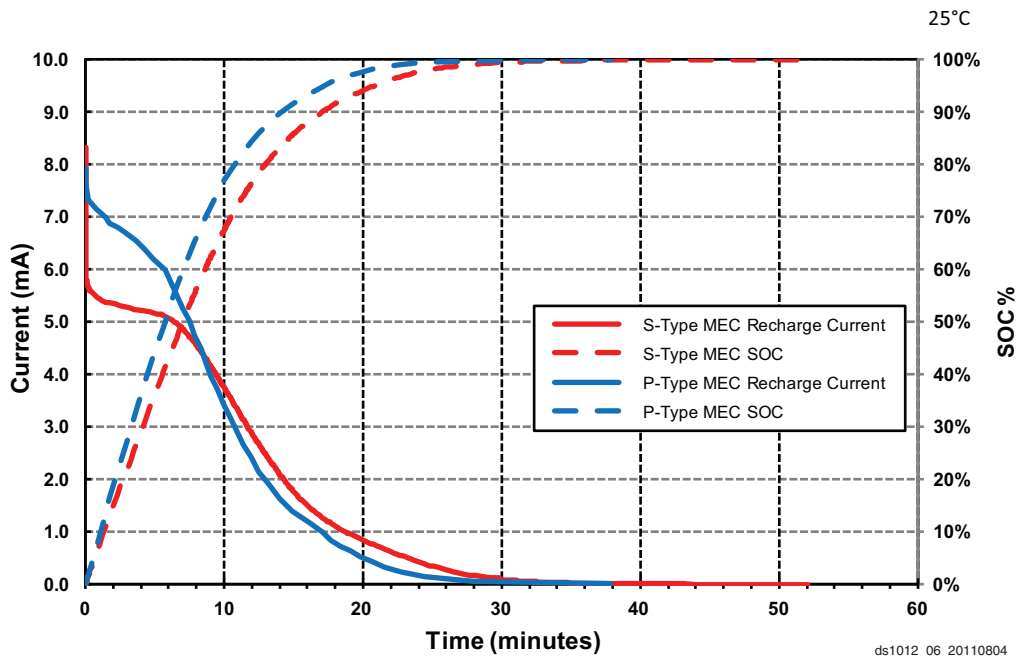

ds1012_06_20110804

Figure 6: Typical Charge Curve @ 25°C — All Capacity Options

Shelf Life and Self-Discharge Characteristics

Typical energy storage devices such as batteries and super capacitors exhibit self discharge behavior that prevents them from being used in many applications where the stored energy must be retained for periods in excess of ten years or more. Temperature changes that occur in typical applications also have a strong effect on the self-discharge rates of these devices, normally resulting in much higher self-discharge rates as temperature increases. Traditional energy storage devices that have acceptable self-discharge rates at room temperature can easily become unsuitable at elevated temperatures due to elevated self-discharge rates. In contrast, IPS MEC technology consistently demonstrates world leading self-discharge behavior, allowing MECs to be used in place of traditional energy storage devices in applications where decades of use without maintenance are required.

MECs have a distinct advantage over traditional energy storage devices in that they possess a solid state electrolyte. This solid state electrochemical system prevents the high self-discharge rates and premature device failures found in other electrochemical systems using liquid electrolytes.

Shelf life will be determined by the condition of the energy storage device as the open circuit voltage (OCV) decreases over time in the application environment. Device or application failure occurs when the cell voltage drops below the useable cutoff voltage of the application, or when the residual capacity at a given voltage level is no longer sufficient to perform a task demanded by the application without recharge being supplied.

Figure 7 shows the typical MEC state of charge as a function of the open circuit voltage. Note that a great deal of MEC capacity is reserved between 3.9 and 4.0V.

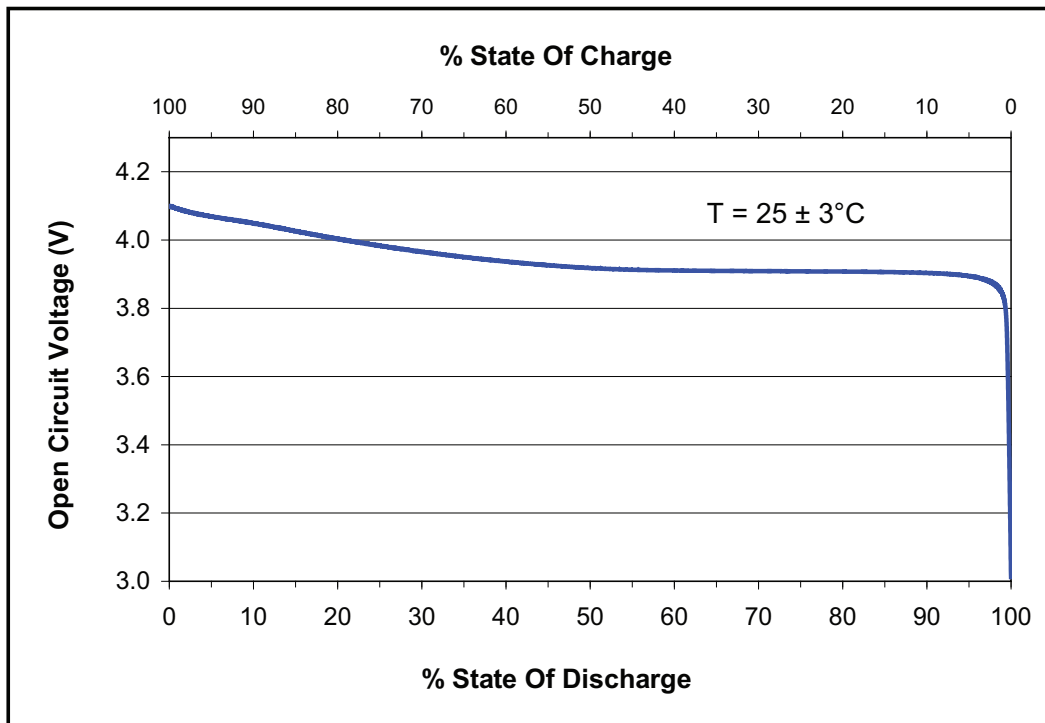

ds1012_07_20110719

Figure 7: OCV as a Function of State of Charge at 25°C

Self-Discharge Performance

In applications where no external load is applied to the MEC, it will experience self-discharge exhibited by an observable decrease in the OCV that is measured on the cell. [Figure 8](#) shows a typical self-discharge curve gener-

ated from MEC test data over one year of self-discharge at 25°C. The self-discharge rate increases with temperature, but remains lower than any other energy storage device.

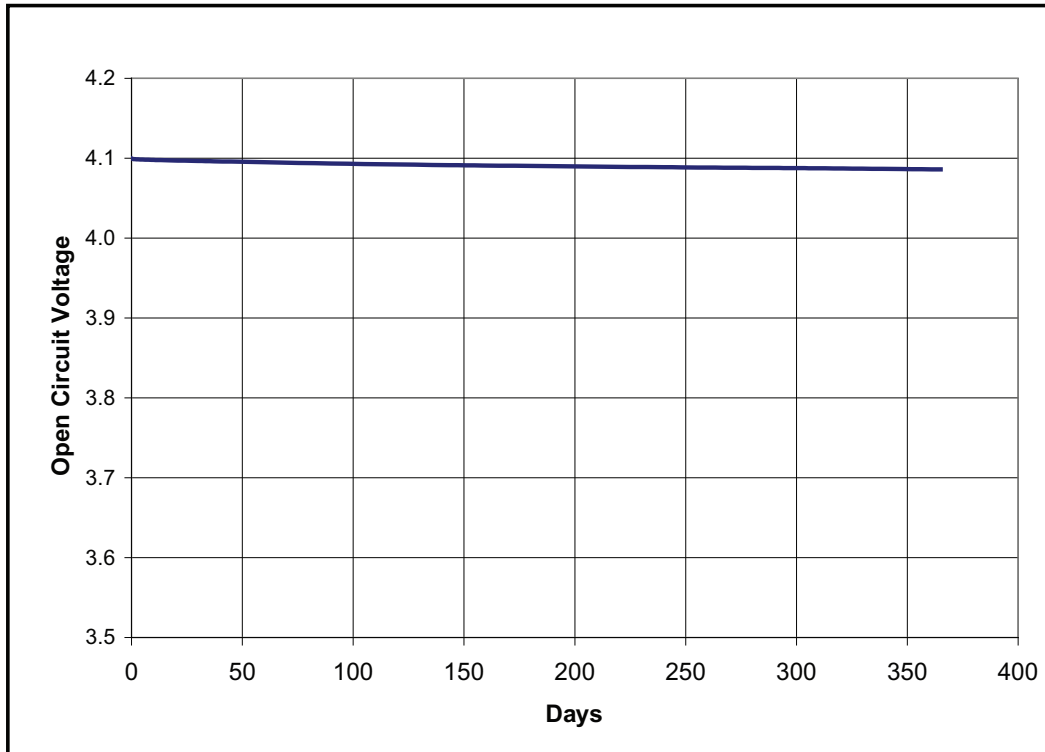

ds1012_08_20110719

Figure 8: Typical Voltage Decay over One Year at 25°C

Figure 9 shows an extrapolated ten year self-discharge curve. Extrapolation is used since no known failure mechanism has been identified in MECs that would cause the discharge curve to deviate from observed normal discharge behavior. As noted previously, the MEC capacity is

largely reserved in the voltage region between 3.9 and 4.0V. This demonstrates that the MEC capacity has been reduced by only a fraction, even after ten years of storage at room temperature. Figure 10 shows the extrapolated remaining MEC capacity after 10 years of storage time.

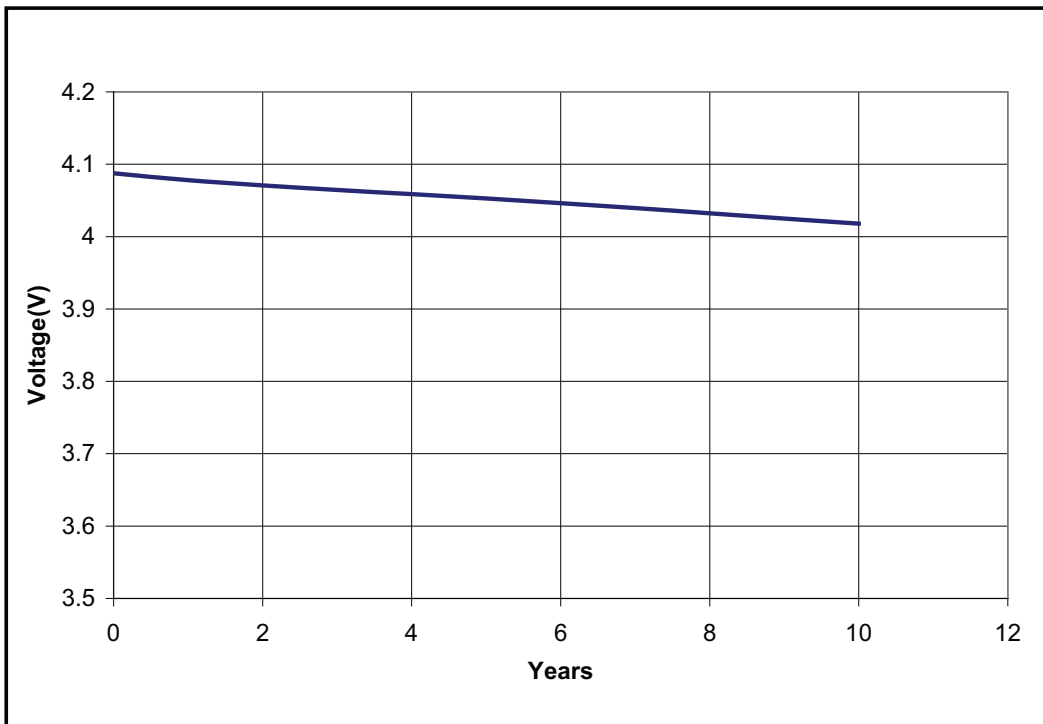

ds1012_09_20110719

Figure 9: Ten-Year Extrapolated Voltage Decay at 25°C

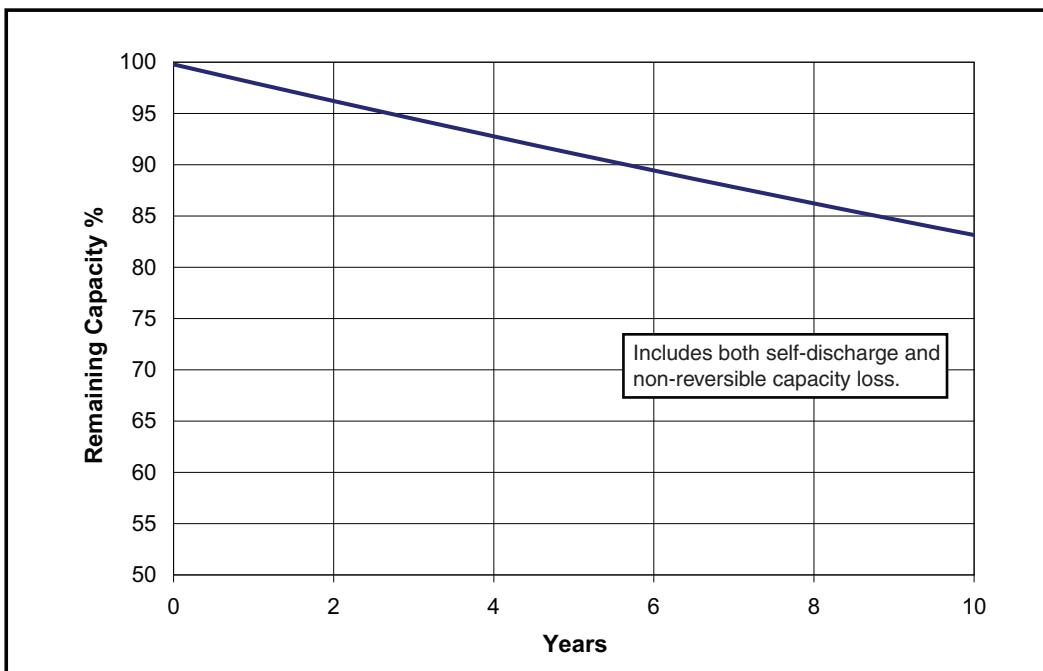

ds1012_10_20110812

Figure 10: Extrapolated Ten-Year Remaining Capacity at 25°C

Package Dimensions

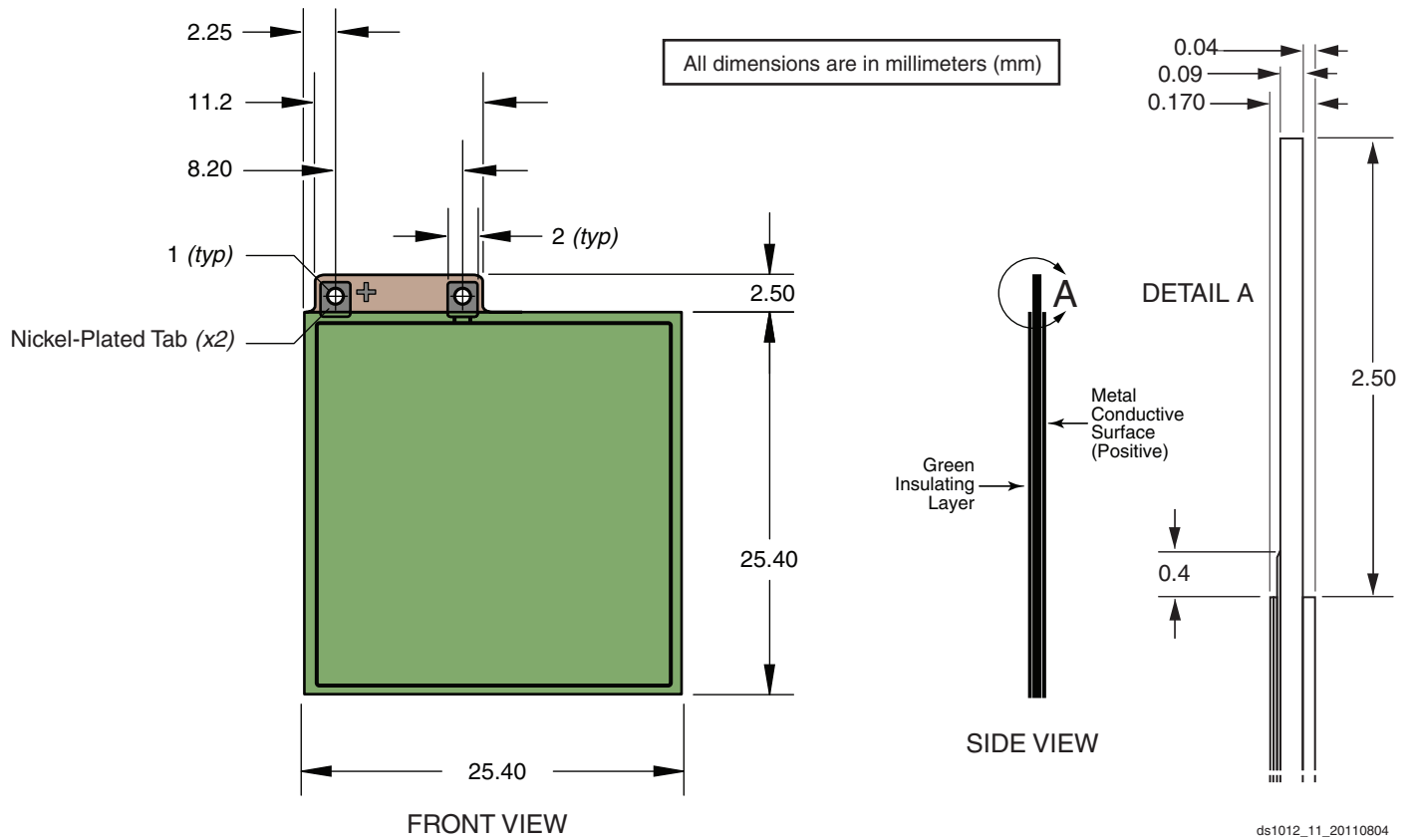
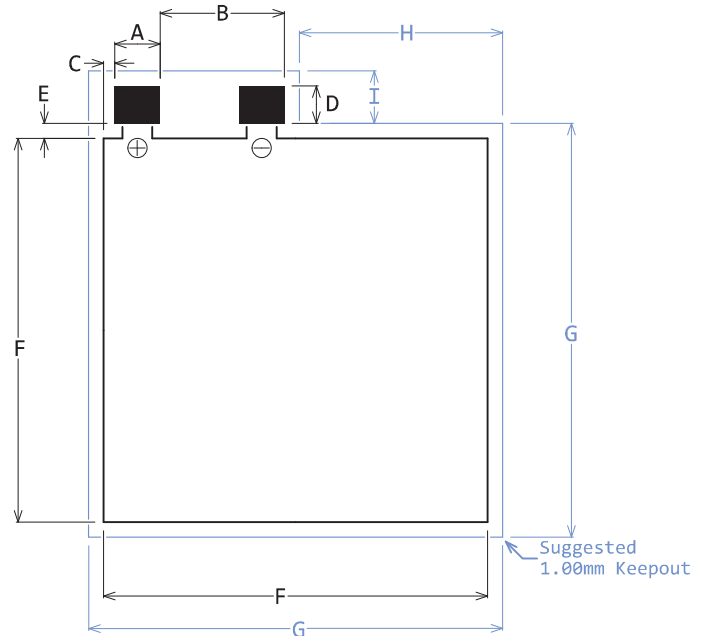

Figure 11: Front and Side Views

PCB Land Pattern Dimensions

Drawing (A) Green (Insulated) Side Up

Dim.	mm	in.
A	3.00	0.118
B	8.20	0.322
C	0.75	0.029
D	2.50	0.098
E	1.00	0.039
F	25.40	1.000
G	27.40	1.078
H	13.45	0.529
I	3.50	0.137



Note: The orientation of this land pattern is such that the MEC201 must be placed with the green (solder mask) side facing away from the board. If your design requires the green (solder mask) side to face the board because of exposed pads, etc., then this land pattern must be mirrored. See Drawing (B) below.

Drawing (B) Green (Insulated) Side Down

Dim.	mm	in.
A	3.00	0.118
B	8.20	0.322
C	0.75	0.029
D	2.50	0.098
E	1.00	0.039
F	25.40	1.000
G	27.40	1.078
H	13.45	0.529
I	3.50	0.137

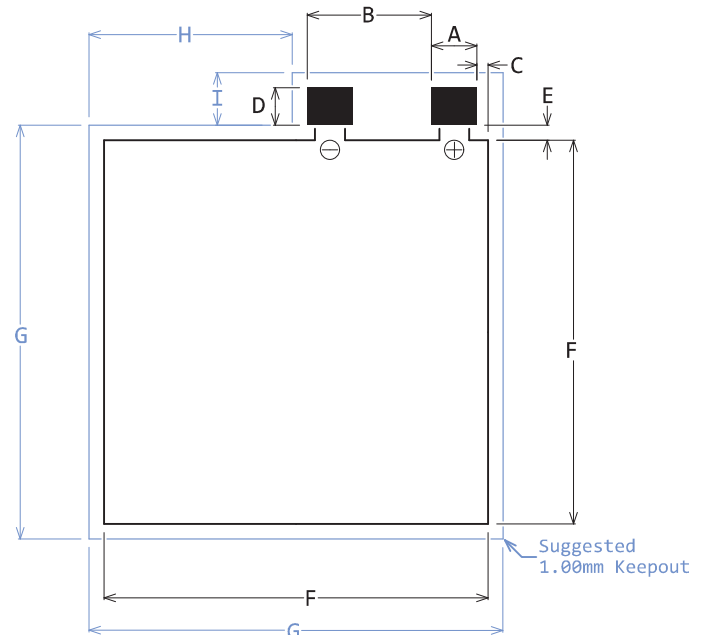

Note: The orientation of this land pattern is such that the MEC201 must be placed with the green (solder mask) side facing toward the board. If your design requires the green (solder mask) side to face away from the board because of cosmetics, etc., then this land pattern must be mirrored. See Drawing (A) above.

ds1012_12_20110804

Figure 12: PCB Land Pattern

Ordering Information

The complete IPS part number is as follows:

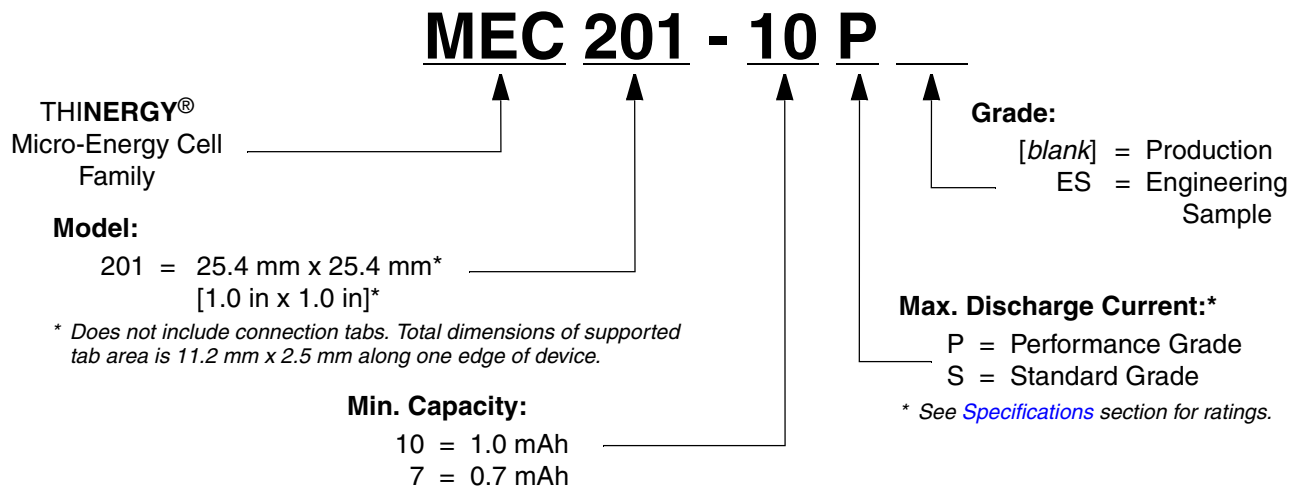

Related Documents

Document	Description
AN1014	<i>A Guide to Handling, Connecting, and Charging THINERGY® MEC200-Series Micro Energy Cells.</i>

Related Products

P/N	Description	Capacity	Current	Voltage
MEC202	Micro-Energy Cell (25.4 mm x 50.8 mm)	1.7–2.5 mAh	75–100 mA	4V
MEC220	Micro-Energy Cell (25.4 mm x 12.7 mm)	300–400 µAh	10–15 mA	4V
MEC225	Micro-Energy Cell (12.7 mm x 12.7 mm)	130 µAh	5–7 mA	4V

Available Development Tools

P/N	Description
ADP	Application Development Platform (includes three PCB-mounted MEC devices. Additional PCB-mounted MEC devices can be ordered.)
IPS-EVAL-EH-01	Universal Energy Harvesting Evaluation Kit Ideal for developing and evaluating various energy harvesting solutions for self-powered applications. Contains THINERGY MEC, Maxim MAX17710 power management IC, and solar cell. Supports any externally connected AC or DC energy harvester.

For more information on this and other IPS battery products, visit the IPS web site, or contact us at 303-749-4800 or sales@ipsbatteries.com.

Infinite Power Solutions, Inc.
11149 Bradford Road
Littleton, Colorado 80127 USA
303-749-4800
www.InfinitePowerSolutions.com