

## AC Hour Meter, Series T50

211

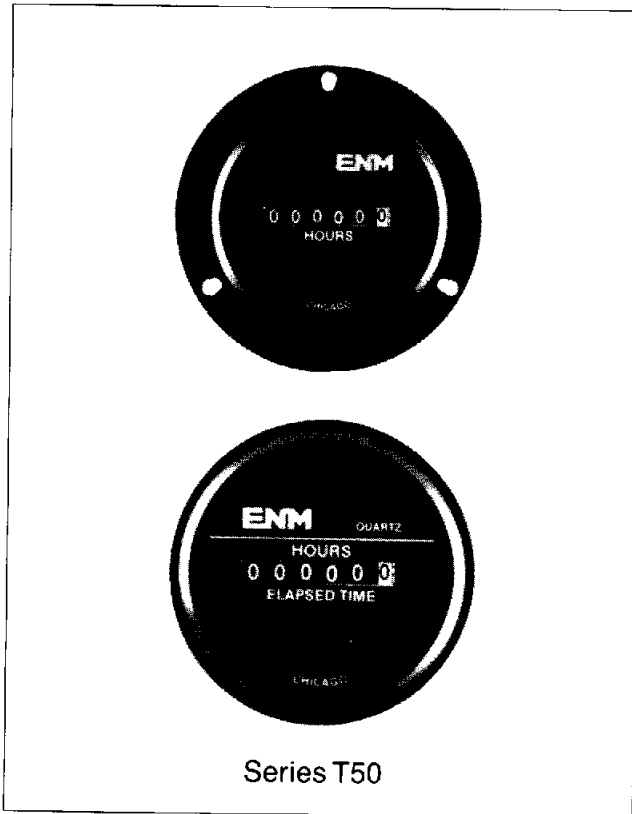

### FEATURES:

- Solid State Electronic Circuit
- Quartz-Crystal for Accurate Timing
- Absolutely Will Not Lose Count
- High Impact, Tamperproof Plastic Case
- Sealed Against Moisture and Dirt
- UL and CSA Recognized
- Indicates Operating Time in Hours and Tenths
- Frequency Insensitive Design
  
- With Optional Gasket, complies to NEMA 4X and 12
  
- **MADE IN THE USA**

2001 ENM Co. Patent Pending



ENM's Series T50 electronic AC hour meter is a low cost reliable hour meter incorporating the latest state-of-the-art in electronics. It's quartz-crystal time base insures accurate long term time-keeping.

A reliable electromechanical wheel-type indicator is used to store accumulated hours.

This compact tamperproof meter is sealed against the environment to provide years of service.

The T50 elapsed time indicator was designed for use on test and recording equipment, for providing maintenance control, for establishing warranty programs, for measuring machine utilization and production time, or for any application where time-in-use is to be determined.

### SPECIFICATIONS:

Time Scale:	6-digits 99,999.9 Hours Automatic recycle to zero
Figures:	Hours — White on black Tenths — Red on White Height — 0.140"
Operating Voltage:	230,115,24V AC+10% Other Voltage available
Frequency:	50 or 60 Hz
Power Consumption:	Less than 0.4 Watts
Accuracy:	Better than $\pm 0.02\%$ over entire range
Temperature:	From -30° C to 65°
Vibration Resistance:	Withstands 10 to 75 hz at 1 to 8 g's
Termination:	1/4" male blade terminals
Configuration:	Round 3-hole Bezel Round SAE Bezel with new push-on retaining ring

E-MAIL  
ENM Co. @ AOL.COM  
Toll Free (888) 372-0465

ENM Company  
5617 Northwest Highway  
Chicago, IL 60646-6135  
(773) 775-8400 Fax: (773) 775-5968

# Series T50 AC

# Dimensional Data

## Panel Gasket UL/NEMA 4X,12

**Description**    **Part No.**  
NEMA Gasket        A40047-S

NEMA Gasket  
w/ Mounting Hardware B20017

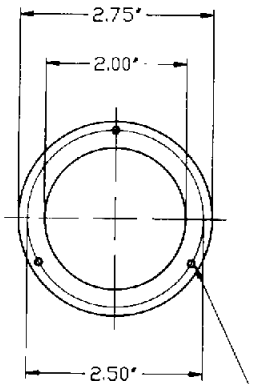

.100" Dia. undersize for #6 screw  
3 Holes Equally Spaced

## Round 3-Hole Bezel

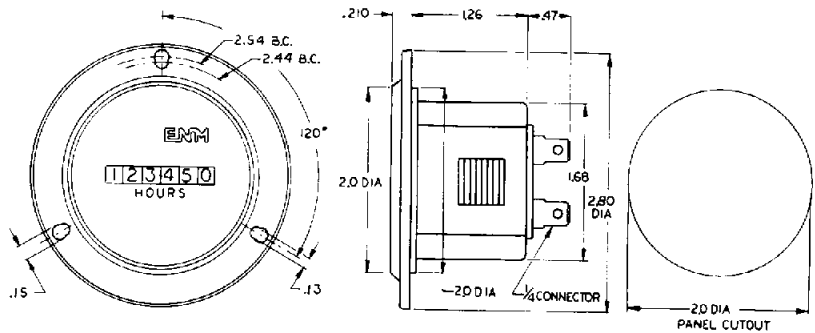

## Round SAE Bezel

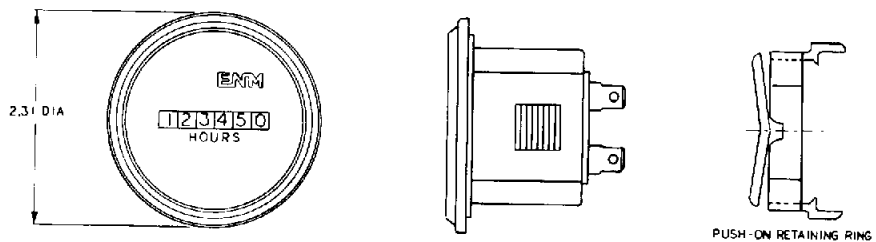

Power: Less than 0.4 Watts

Voltage	Part No.
230 AC	T50A1
115 AC	T50A2
24 AC	T50A4

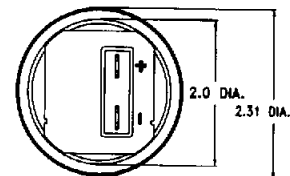
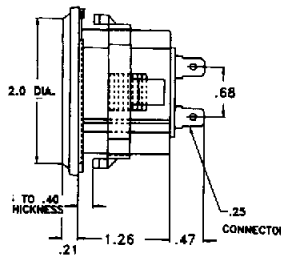
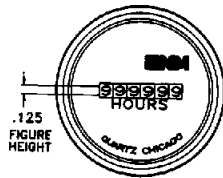

Technical Data Sheet #211

Power: Less than 0.4 Watts

Voltage	Part No.
230 AC	T50B1
115 AC	T50B2
24 AC	T50B4

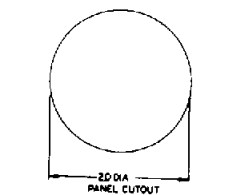
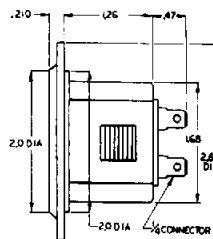
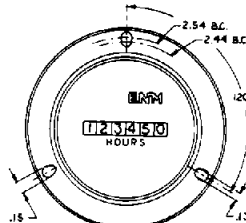

Technical Data Sheet #211

## Limited Warranty/Hour Meters

ENM Company hour meters are warranted to the consumer to be free from defects in material and workmanship for a period of 10,000 operating hours or for a period of 3 years, whichever first occurs.

All ENM products which fall within the warranty period due to defects in material or workmanship will be repaired or replaced, at ENM's option, without charge to the consumer when returned with proof of purchase to any authorized ENM dealer in the United States, transportation charges prepaid, provided there is no evidence of improper installation, tampering, or other abuse.

All implied warranties, including any implied warranty of merchantability or fitness for a particular purpose, shall be limited in duration to the express warranty period specified above.

ENM disclaims any liability for consequential damages due to breach of any written or implied warranty on its hour meters.

2001 ENM Co.

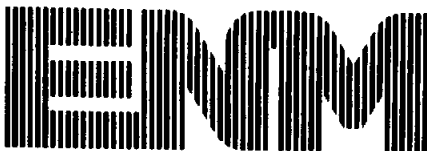

ENM Company  
5617 Northwest Highway  
Chicago, IL 60646-6135  
(773) 775-8400 Fax: (773) 775-5968