

# DESCRIPTION OF TERMINOLOGY

	ITEMS	SYMBOLS	DEFINITION	UNIT
Absolute Max. Ratings	Power dissipation	(Pd)	Power dissipated by forward current and forward voltage	(mW)
	Forward current	(If)	Current from anode to cathode	(mA)
	Peak forward current	(IfM)	Forward peak current driven during pulse lighting	(mA)
	Current derating	(ΔIf)	Derating over 25°C ambient temperature	(mA/°C)
	Forward voltage	(Vf)	Voltage drop when forward current goes from anode to cathode	(V)
Electro-optical characteristics	Reverse current	(Ir)	Leakage current when bias voltage is applied from cathode to anode	(μA)
	Luminous intensity	(Iv)	Flux in lumens per unit of solid angle on optical axis	(mcd)
	Peak wavelength	(λp)	Wavelength at which radiant intensity becomes greatest	(nm)
	Spectral line half width	(Δλ)	Wavelength range in which radiant intensity becomes more than 50% of its peak value	(nm)

## RELIABILITY TEST AND MEASURING METHOD

### Items to be Guaranteed for LEDs

TEST ITEM	STANDARDS	TEST CONDITION	SAMPLE SIZE
Operating Endurance Test	JIS C 7035 Added documents	Ta=25°C, If=Maximum Rated Current, t=1000 Hrs.	25
Resistance to Soldering Heat	JIS C 7021 A-1	260±5°C, 10±1 sec., 3mm from package base	25
Temperature Cycling	JIS C 7021 A-4	-30°C (30 min) to normal temperature (15 min) to +100°C (30 min) To normal temperature (15 min) 5 cycles	25
Humidity (Steady State)	JIS C 7021 B-11	Ta=60±2°C, RH=90±5%, t=1000Hr	25
High Temperature (Storage)	JIS C 7021 B-10	Ta=100±2°C, t=1000Hr	25
Low Temperature (Storage)	JIS C 7021 A-12	Ta=30±2°C, t=1000Hr	25
Lead Tension	JIS C 7021 A-11	*1kg/10 sec. one time (thin lead: 0.5kg)	10
Vibration Fatigue	JIS C 7021 A-10	10G, 100 to 2000Hz sweep for 20 min., 2 hours for directions X, Y and Z	10

### Measuring Method

Luminous Intensity (Iv)

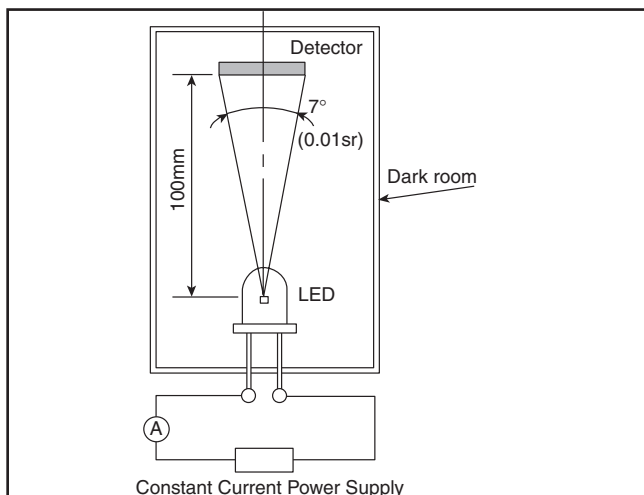

### Structural Drawing for Numeric Display

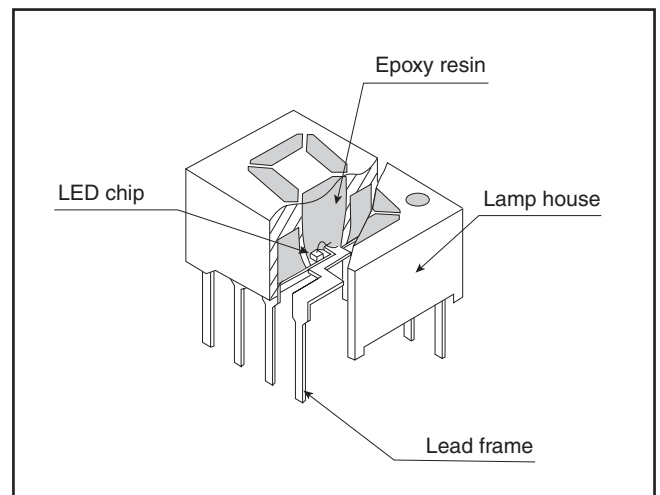

# HANDLING PRECAUTIONS

## Soldering Conditions

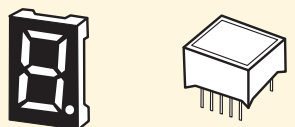
TYPES	SOLDERING IRON	DIP SOLDERING	REFLOW SOLDERING
	Temperature at tip of iron: 300°C max. (30 W max.) Soldering time: 3 sec. max Location: At least 3.0mm away from resin body	Pre-heating: 80°C max. (Resin surface temperature) 60 sec. max Bath temperature: 260°C max. Dipping time: 5 sec. max. Location: At least 3.0mm away from resin body	Not recommended

## Cleaning

Residual solder or flux left on the LED housing could reduce intensity and could affect the optical characteristics. Excess flux can be removed by the following chemical method:

1. Cleaning solvents (dipping time: 3 minutes maximum at normal temperature)
  - Ethyl alcohol
  - Isopropyl alcohol
  - Pure water (after cleaning, the water must be removed by drying)
  - Drying condition: 90°C max., 30 sec. max. and 4 times max.
2. The effect of ultrasonic cleaning on the LED resin body depends on such factors as the oscillator output, size of PCB and LED mounting method. Ultrasonic cleaning is strongly recommended after confirming that there are no problems.
  1. Ultrasonic wave frequency: 28 kHz or 40 kHz
  2. Output: 20 W/l
3. The solvent for freon equivalent (recommended after confirming that there are no problems).
  - AK-225AES
  - Clean through
  - Pine alpha ST-100S

Chemicals	Freon substitute detergent
Ethyl alcohol	AK225AES
Isopropyl alcohol	Clean through 705H
Pure water	Pine alpha ST-100S

\* DIP Soldering and cleaning is not recommended for Alpha-Numeric (AAR121 and AAA121) LED displays.

# SUPER BRIGHT LED LIGHT BAR MODULE

Stanley's MU series of super-bright LED light bar modules can be selected from a wide variety of configurations and colors to suit a broad range of requirements. By using front mask patterns, including letters, numbers and even graphics, this series is usable for a myriad of display applications.

## Description of Part Number

# MU 02 - 2201

Shape Code      Emitted color      Suffix  
 2.Red 3.Orange 4.Yellow 5.Green / Pure Green

## Characteristics by Color

Ta=25°C

Part No.	Material Emitted Color	Absolute Maximum Ratings						Electro-Optical Characteristics							
		Forward Current	Peak Forward Current	Reverse Voltage	Operating Temperature	Storage Temperature	Derating	Forward Voltage			Reverse Current		Wavelength		IF
		IF $\diamond$ 1	IFM $\diamond$ 2	VR	ToPr $\diamond$ 3	Tstg $\diamond$ 4	$\Delta$ IF	TYP.	MAX.	IF	MAX.	VR	Peak $\lambda_p$ TYP.	Spectral Line Half Width $\Delta\lambda$ TYP.	
2□□□	GaAlAs (Red)	30	60	4	-40~+85	-40~+85	0.40	1.7	2.0	20	20	4	660	30	20
3□□□	GaAsP (Orange)	25	60	4	-40~+85	-40~+85	0.33	2.2	2.5	20	20	4	605	30	20
4□□□	GaP (Yellow)	30	60	4	-40~+85	-40~+85	0.40	2.1	2.5	20	20	4	570	30	20
5□□1	GaP (Green)	25	60	4	-40~+85	-40~+85	0.33	2.2	2.5	20	20	4	555	30	20
5□□2	GaP (Green)	30	60	4	-40~+85	-40~+85	0.40	2.1	2.5	20	20	4	560	30	20
5□□5	GaP (Pure Green)	25	60	4	-40~+85	-40~+85	0.33	2.2	2.5	20	20	4	555	30	20
9□□1	GaAlAs (Red)	30	60	4	-40~+85	-40~+85	0.40	1.7	2.0	20	20	4	660	30	20
	GaP (Green)	25	60	4	-40~+85	-40~+85	0.33	2.2	2.5	20	20	4	555	30	20
9□□2	GaAlAs (Red)	30	60	4	-40~+85	-40~+85	0.40	1.7	2.0	20	20	4	660	30	20
	GaP (Yellow)	30	60	4	-40~+85	-40~+85	0.40	2.1	2.5	20	20	4	570	30	20
9□□3	GaAlAs (Red)	30	60	4	-40~+85	-40~+85	0.40	1.7	2.0	20	20	4	660	30	20
	GaAsP (Orange)	25	60	4	-40~+85	-40~+85	0.33	2.2	2.5	20	20	4	605	30	20
Units		mA	mA	V	°C	°C	mA/°C	V	V	mA	$\mu$ A	V	nm		mA



$\diamond$  1 : MU91, MU92 and MU93 series are all 30 mA.

$\diamond$  2 : tw $\leq$ 2 msec, duty  $\leq$ 1/5 However, for the MU91, MU92 and MU93 series, 300 mA for red and 100 mA for yellow, orange and pure green (tw  $\leq$ 1 msec, duty  $\leq$ 1/20)

$\diamond$  3  $\diamond$  4 : For MU91, MU92 and MU93 series, the temperature range is -30°C to +85°C.

## Characteristics by Shape

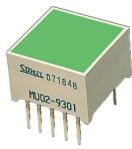
Ta=25°C

Shape	Part No.	Emitted Color	Resin Color	Light Emitting Surface (Outer Size)	No. of Chips	Absolute Max. Rating	Electro-Optical Characteristics			fig.
						Power Dissipation Pd	Luminous Intensity Iv			
							MIN.	TYP.	IF	
	MU02-2201	Red	Red	14 x 14 (15 x 15)	4	240	20	42	20	1
	MU02-2205		Milky White		4	240	20	42	20	
	MU02-3201	Orange	Orange		4	250	10	20	20	
	MU02-3205		Milky White		4	250	10	20	20	
	MU02-4201	Yellow	Yellow		4	300	20	42	20	
	MU02-4205		Milky White		4	300	20	42	20	
	MU02-5201	Pure Green	Green		4	250	10	20	20	
	MU02-5202	Green	Green		4	300	15	32	20	
	MU02-5205	Pure Green	Milky White		4	250	10	20	20	
	MU02-9301	Red	Green		4	240	8	12	20	
Pure Green		4		250	8	12	20			
	MU03-2201	Red	Red	6 x 9 (7 x 10)	2	120	10	20	20	3
	MU03-2205		Milky White		2	120	10	20	20	
	MU03-3201	Orange	Orange		2	125	5	10	20	
	MU03-3205		Milky White		2	125	5	10	20	
	MU03-4201	Yellow	Yellow		2	150	10	20	20	
	MU03-4205		Milky White		2	150	10	20	20	
	MU03-5201	Pure Green	Green		2	125	3	7	20	
	MU03-5202	Green	Green		2	150	8	16	20	
	MU03-5205	Pure Green	Milky White		2	125	5	10	20	
	MU03-9201	Red	Milky White		1	60	5	7	20	
		Pure Green			1	62.5	3	4	20	
Units			mm	pcs	mW	mcd		mA		

## Package Dimensions

unit : mm

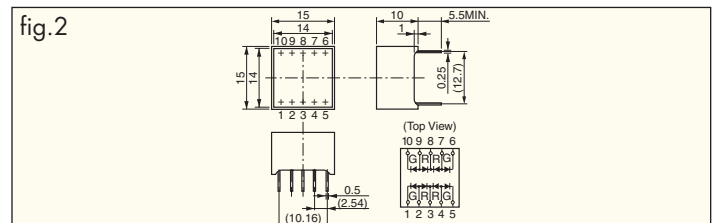
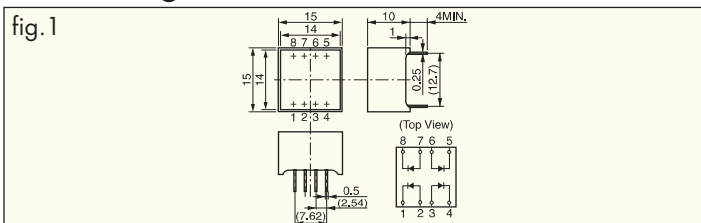

Tolerance :  $\pm$ 0.25mm



# SUPER BRIGHT LED LIGHT BAR MODULE

## Characteristics by Shape

Ta=25°C

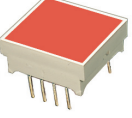
Shape	Part No.	Emitted Color	Resin Color	Light Emitting Surface (Outer Size)	No. of Chips	Absolute Max. Rating Power Dissipation Pd	Electro-Optical Characteristics			fig.	
							Luminous Intensity Iv				
							MIN.	TYP.	IF		
	MU04-2101	Red	Red	6X19 (7X20)	3	180	15	32	20	4	
	MU04-2105		Milky White		3	180	15	32	20		
	MU04-3101	Orange	Orange		3	190	8	16	20		
	MU04-3105		Milky White		3	190	8	16	20		
	MU04-4101	Yellow	Yellow		3	225	15	32	20		
	MU04-4105		Milky White		3	225	15	32	20		
	MU04-5101	Pure Green	Green		3	190	8	16	20		
	MU04-5102	Green	Green		3	225	10	20	20		
	MU04-5105	Pure Green	Milky White		3	190	8	16	20		
	MU07-2101	Red	Red	6X29 (7X30)	5	300	20	40	20	5	
	MU07-3101	Orange	Orange		5	320	10	20	20		
	MU07-4101	Yellow	Yellow		5	375	20	40	20		
	MU07-5101	Pure Green	Green		5	320	10	20	20		
	MU08-2201	Red	Red	14X16 (15X17)	4	240	20	40	20	6	
	MU08-3201	Orange	Orange		4	250	10	20	20		
	MU08-4201	Yellow	Yellow		4	300	20	40	20		
	MU08-5201	Pure Green	Green		4	250	10	20	20		
	MU08-9301	Red	Green		4	240	8	12	20	20	7
		Pure Green			4	250	8	12	20	20	
Units				mm	pcs	mW	mcd		mA		

## Package Dimensions

unit : mm

Tolerance : ±0.25mm

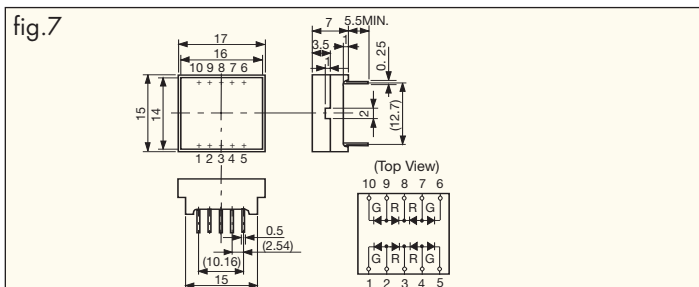
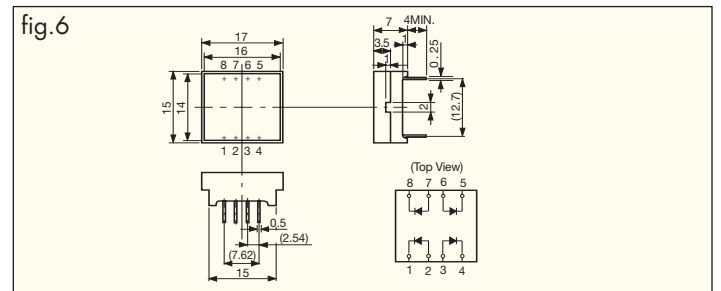
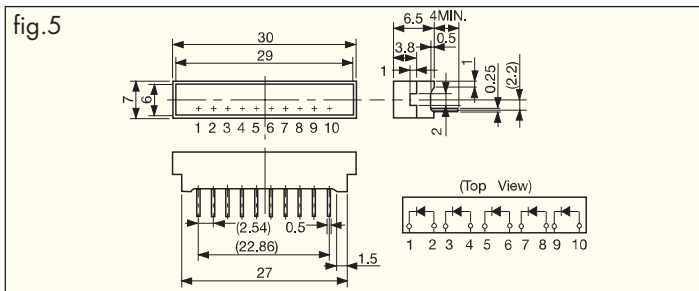
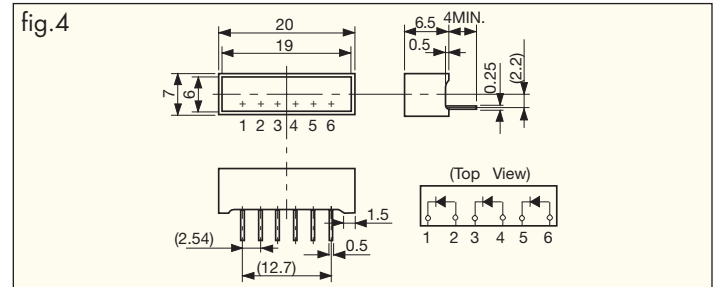
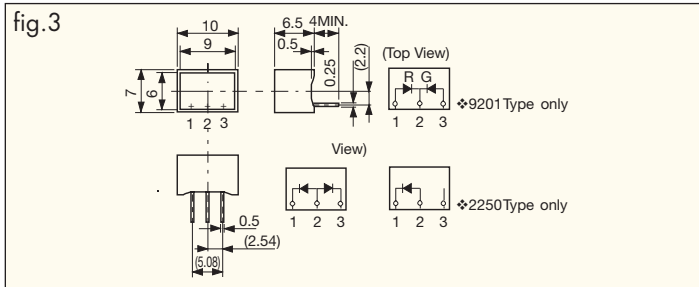

# SUPER BRIGHT LED LIGHT BAR MODULE

## Characteristics by Shape

Ta=25°C

Shape	Part No.	Emitted Color	Resin Color	Light Emitting Surface (Outer Size)	No. of Chips	Absolute Max. Rating	Electro-Optical Characteristics			fig.
							Power Dissipation Pd	Luminous Intensity Iv		
								MIN.	TYP.	
	MU09-9101	Red	Milky White	φ 6.4 (φ 7)	1	60	4	8	20	8
		Pure Green			2	125	4	6	20	
	MU09-9102	Red	Milky White		1	60	4	8	20	
		Yellow			2	150	6	12	20	
	MU09-9103	Red	Milky White		1	60	4	8	20	
		Orange			2	125	4	8	20	
	MU11-2201	Red	Red	4.6X9.5 (5.6X10.5)	2	120	10	20	20	9
	MU11-3201	Orange	Orange		2	125	5	10	20	
	MU11-4201	Yellow	Yellow		2	150	10	20	20	
	MU11-5201	Pure Green	Green		2	125	5	10	20	
	MU13-9101	Red	Milky White	9X9 (10.1X10.1)	1	60	6	12	20	10
		Pure Green			5	310	7	14	20	
	MU13-9102	Red	Milky White		1	60	6	12	20	
	MU16-2101	Red	Red	4X12 (5X13)	2	120	8	16	20	11
	MU16-2105		Milky White		2	120	8	16	20	
	MU16-3101	Orange	Orange		2	125	6	12	20	
	MU16-3105		Milky White		2	125	6	12	20	
	MU16-4101	Yellow	Yellow		2	150	8	16	20	
	MU16-4105		Milky White		2	150	8	16	20	
	MU16-5101	Pure Green	Green		2	125	4	8	20	
	MU16-5105		Milky White		2	125	4	8	20	
	MU17-2101	Red	Red	4X19 (5X20)	3	180	12	24	20	12
	MU17-2105		Milky White		3	180	12	24	20	
	MU17-3101	Orange	Orange		3	190	9	18	20	
	MU17-3105		Milky White		3	190	9	18	20	
	MU17-4101	Yellow	Yellow		3	225	12	24	20	
	MU17-4105		Milky White		3	225	12	24	20	
	MU17-5101	Pure Green	Green		3	190	5	10	20	
	MU17-5105		Milky White		3	190	5	10	20	
Units				mm	pcs	mW	mcd		mA	

## Package Dimensions

unit : mm



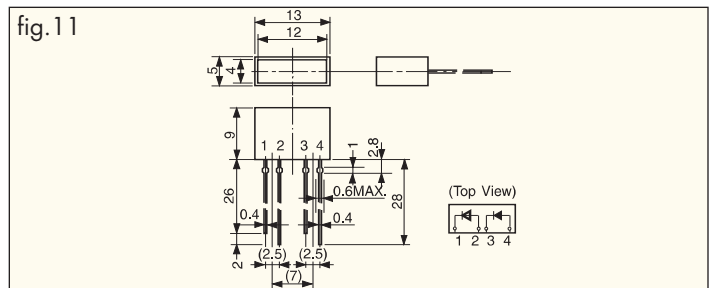
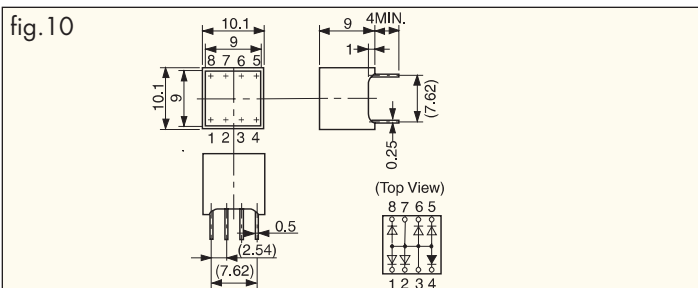
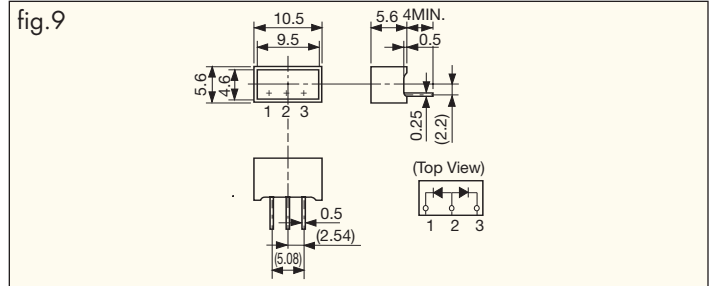
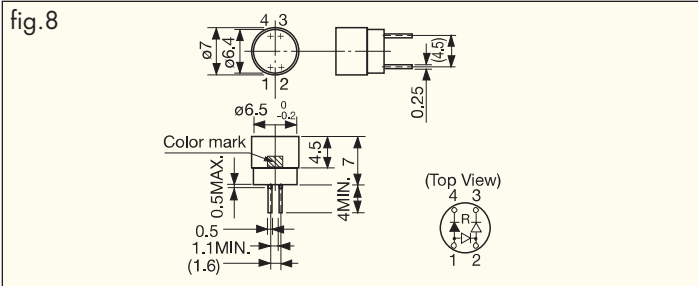

Tolerance : ±0.25mm



# SUPER BRIGHT LED LIGHT BAR MODULE

## Characteristics by Shape

Ta=25°C

Shape	Part No.	Emitted Color	Resin Color	Light Emitting Surface (Outer Size)	No. of Chips	Absolute Max. Rating Power Dissipation Pd	Electro-Optical Characteristics			fig.
							Luminous Intensity Iv		IF	
							MIN.	TYP.		
	MU20-2101	Red	Red	5X9 (6X10)	1	60	4	8	20	13
	MU20-2105		Milky White		1	60	4	8	20	
	MU20-3101	Orange	Orange		1	62.50	3	6	20	
	MU20-3105		Milky White		1	62.50	3	6	20	
	MU20-4101	Yellow	Yellow		1	75	4	8	20	
	MU20-4105		Milky White		1	75	4	8	20	
	MU20-5101	Pure Green	Green		1	62.50	2	4	20	
	MU20-5105		Milky White		1	62.50	2	4	20	
	MU91-2001	Red	Red	6X6 (6X6)	1	60	3	6	20	14
	MU91-3001	Orange	Orange		1	75	3	6	20	
	MU91-4001	Yellow	Yellow		1	75	3	6	20	
	MU91-5001	Pure Green	Green		1	75	1.2	2.4	20	
	MU92-2001	Red	Red	9X5 (9X5)	1	60	3	6	20	15
	MU92-3001	Orange	Orange		1	75	3	6	20	
	MU92-4001	Yellow	Yellow		1	75	3	6	20	
	MU92-5001	Pure Green	Green		1	75	1.2	2.4	20	
	MU93-2001	Red	Red	10X10 (10X10)	1	60	4	8	20	16
	MU93-3001	Orange	Orange		1	75	4	8	20	
	MU93-4001	Yellow	Yellow		1	75	4	8	20	
	MU93-5001	Pure Green	Green		1	75	1.5	3	20	
Units				mm	pcs	mW	mcd		mA	

## Package Dimensions

unit : mm

Tolerance : ±0.25mm

fig.12

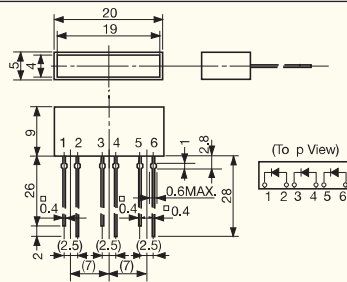

fig.13

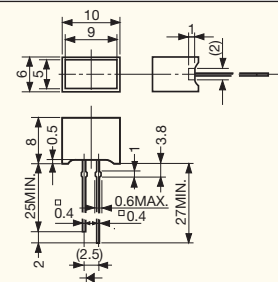

fig.14

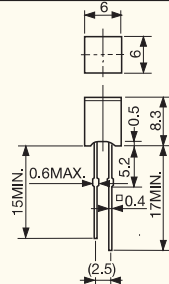

fig.15

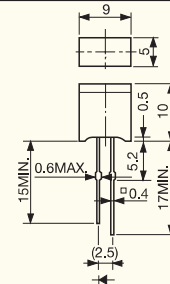
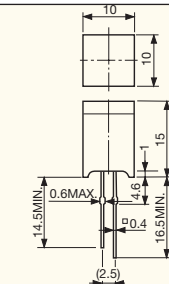

fig.16



# SUPER BRIGHT LED NUMERIC DISPLAY (SEVEN SEGMENT DISPLAY)

Stanley's Numeric Displays which incorporate super-bright LEDs produce vivid, brilliant displays. Available colors are red, pure green, green, yellow and orange. Display types include segment type (character heights 7.5mm to 25mm) and the alpha-numeric type (character heights 25mm and 51mm). These are suitable for dynamic drive due to the low-current drive characteristics.

## Description of Part Number

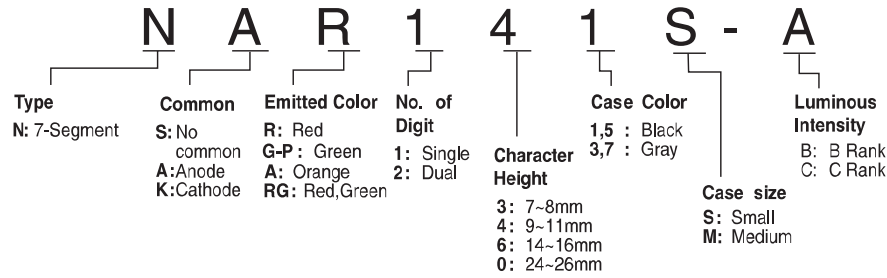

## Characteristics by Color

Ta=25°C

Size	Part No.	Material Emitted Color	Chip/Segment	Absolute Maximum Rating						Electro-Optical Characteristics						Derating ΔIF	
				Power Dissipation Pd	Forward Current IF	Peak Forward Current IFM	Reverse Voltage TR	Operating Temp Topr	Storage Temp Tstg	Forward Voltage VF			Reverse Current IR		Wavelength λp		
										TYP.	MAX.	IF	MAX.	VR	TYP		IF
7.5	N□R13□	GaP(Red)	1	37.5	15	60	4	-30~+85	-30~+85	2.0	2.5	10	100	4	700	10	0.25
	N□R13□S,ME	GaAlAs(Red)	1	40	20	80	4	-30~+85	-30~+85	1.7	2.0	10	100	4	660	10	0.33
	N□G13□P,SP,MP	GaP(Green)	1	48	20	80	4	-30~+85	-30~+85	2.0	2.4	10	100	4	565	10	0.33
	N□13□,S,M	GaAsP(Orange)	1	48	20	80	4	-30~+85	-30~+85	2.0	2.4	10	100	4	605	10	0.33
10	N□R14□,N□R24	GaAlAs(Red)	1	60	30	120	4	-40~+85	-40~+85	1.7	2.0	20	100	4	660	20	0.41
	N□R14□S	GaAlAs(Red)	1	40	20	80	4	-30~+85	-30~+85	1.7	2.0	10	100	4	660	10	0.33
	N□G14□P,N□G24P	GaP(Green)	1	63	25	100	4	-40~+85	-40~+85	2.2	2.5	20	100	4	565	20	0.34
	N□G14□SP	GaP(Green)	1	48	20	80	4	-40~+85	-30~+85	2.0	2.4	10	100	4	565	10	0.33
	N□A14□,N□A24□	GaAsP(Orange)	1	63	25	100	4	-40~+85	-40~+85	2.2	2.5	20	100	4	605	20	0.34
	N□A14□S	GaAsP(Orange)	1	48	20	80	4	-30~+85	-30~+85	2.0	2.4	10	100	4	605	10	0.33
	NARG14□	GaAlAs(Red)	1	36	15	70	4	-30~+70	-30~+80	1.7	2.0	10	100	4	660	10	0.22
		GaP(Green)	1	36	15	70	4	-30~+70	-30~+80	2.0	2.4	10	20	4	570	10	0.22
15	N□R16□,N□R26□	GaAlAs(Red)	1	60	30	120	4	-40~+85	-40~+85	1.7	2.0	20	100	4	660	20	0.41
	N□G16□P,N□G26□P	GaP(Green)	1	63	25	100	4	-40~+85	-40~+85	2.2	2.5	20	100	4	565	20	0.34
	N□A16□,N□A26□	GaAsP(Orange)	1	63	25	100	4	-40~+85	-40~+85	2.2	2.5	20	100	4	605	20	0.34
	NARG16□	GaAlAs(Red)	1	36	15	70	4	-30~+70	-30~+80	1.7	2.0	10	100	4	660	10	0.22
GaP(Green)		1	36	15	70	4	-30~+70	-30~+80	2.0	2.4	10	20	4	570	10	0.22	
25	N□R10□	GaAlAs(Red)	2	120	30	120	4	-20~+85	-20~+85	3.4	4.0	20	100	8	660	20	0.41
	N□G10□P	GaP(Green)	2	126	25	100	4	-20~+85	-20~+85	4.4	5.0	20	100	8	565	20	0.34
	N□A10□	GaAsP(Orange)	2	126	25	100	4	-20~+85	-20~+85	4.4	5.0	20	100	8	605	20	0.34
	NARG10□	GaAlAs(Red)	2	80	20	❖1 40	4	-30~+70	-30~+80	3.4	4.0	10	100	4	660	10	0.33
GaP(Green)		2	96	20	40	4	-30~+70	-30~+80	4.0	4.8	10	100	4	570	10	0.33	
mm	Units			mW	mA	mA	V	°C		V	mA	μA	V	nm	mA	mA/°C	

- Number of chips per segment
- Ratings and specifications are for one segment
- When both colors of a bi-color LED are driven simultaneously, the rating of NARG types are the total of the Pd, 1F and 1FM values.
- ❖1 : NARG 10□ type in dynamic drive has a duty cycle of 1/2 and f=500Hz and the others have a duty cycle of 1/5 and f = 1 kHz.

# SUPER BRIGHT LED NUMERIC DISPLAY

## 7.5mm Type

Ta=25°C

Case Size (WXH)	Shape	Part No.		Emitted Color	Luminous Intensity Iv					fig.
		Anode Common	Cathode Common		MIN.	Rank B TYP.	Rank C MIN.	Rank C TYP.	If	
7.0 X 11.0		<b>NAR131S/133S</b>	<b>NKR131S/133S</b>	Red	1.4	2.8	2.8	5.6	10	1
		<b>NAR131SP/133SP</b>	<b>NKG131SP/133SP</b>	Green	1	2	—	—	10	
		<b>NAA131S/133S</b>	<b>NKA131S/133S</b>	Orange	0.6	1.2	—	—	10	
10.0 X 15.0		<b>NAR131ME/133ME</b>	<b>NKR131ME/133ME</b>	Red	1.2	2.4	—	—	10	2
		<b>NAG131MP/133MP</b>	<b>NKG131MP/133MP</b>	Green	0.6	1.2	—	—	10	
		<b>NAA131M/133M</b>	<b>NKA131M/133M</b>	Orange	0.8	1.6	—	—	10	
10.0 X 19.0		<b>NAR131/133</b>	<b>NKR131/133</b>	Red	0.3	0.6	—	—	10	3
		<b>NAG131P/133P</b>	<b>NKG131P/133P</b>	Green	0.6	1.2	—	—	10	
		<b>NAA131/133</b>	<b>NKA131/133</b>	Orange	0.8	1.6	—	—	10	
mm		Units			mcd					mA

## Package Dimensions

unit : mm

Tolerance : ±0.25mm

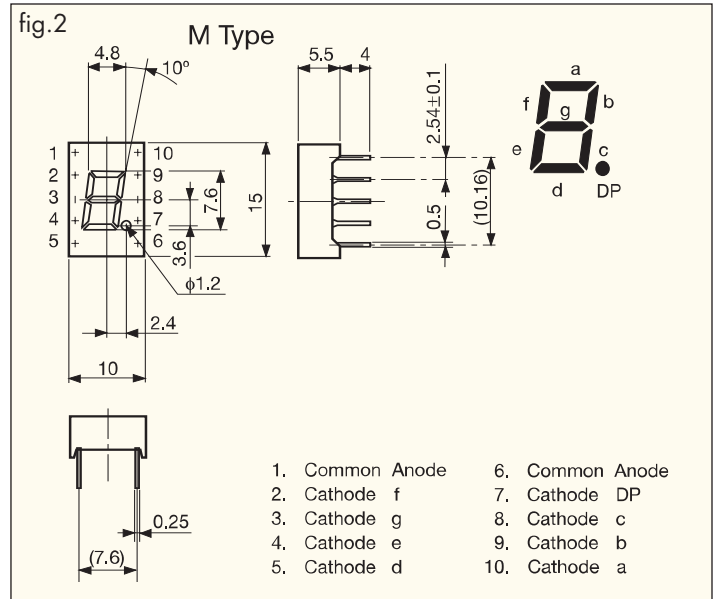
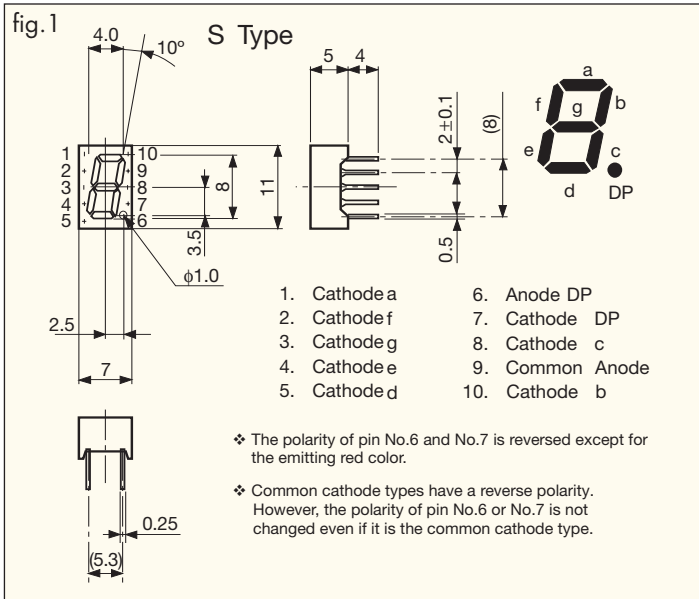

● Common cathode types shown in fig. 2 and 3 have a reverse polarity.

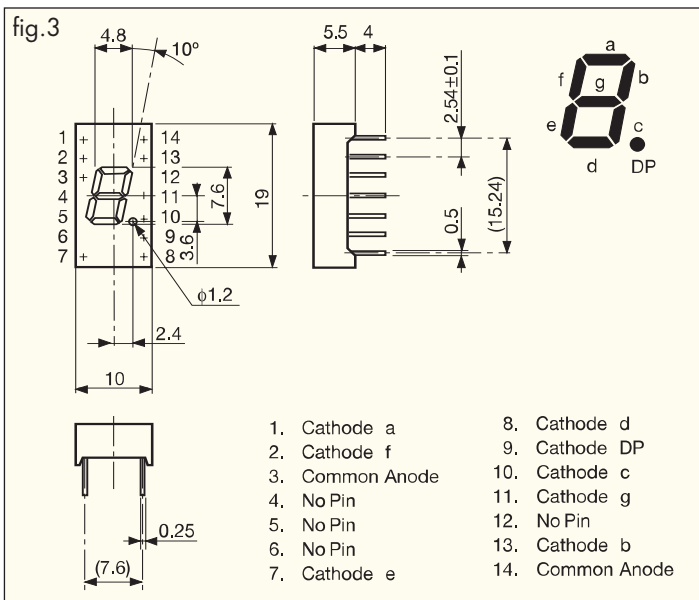





# SUPER BRIGHT LED NUMERIC DISPLAY

## 10mm Type

Ta=25°C

Case Size (WXH)	Shape	Part No.	Emitted Color	Luminous Intensity Iv					fig.	
				MIN.	Rank B	TYP.	MIN.	Rank C		TYP.
12.5 X 19.0	Square shape type 	<b>NSR141/143</b>	Red	4	8	8	8	11	20	4
		<b>NSG141P/143P</b>	Green	1	2	—	—	—	20	
		<b>NSA141/143</b>	Orange	3	6	—	—	—	20	
12.5 X 19.0	Arrow feather type 	<b>NSR145/147</b>	Red	3.2	6.4	6.4	6.4	8.8	20	5
		<b>NSG145P/147P</b>	Green	0.8	1.6	—	—	—	20	
		<b>NSA145/147</b>	Orange	2.4	4.8	—	—	—	20	
mm		Units		mcd					mA	

## Package Dimensions

unit : mm

Tolerance : ±0.25mm

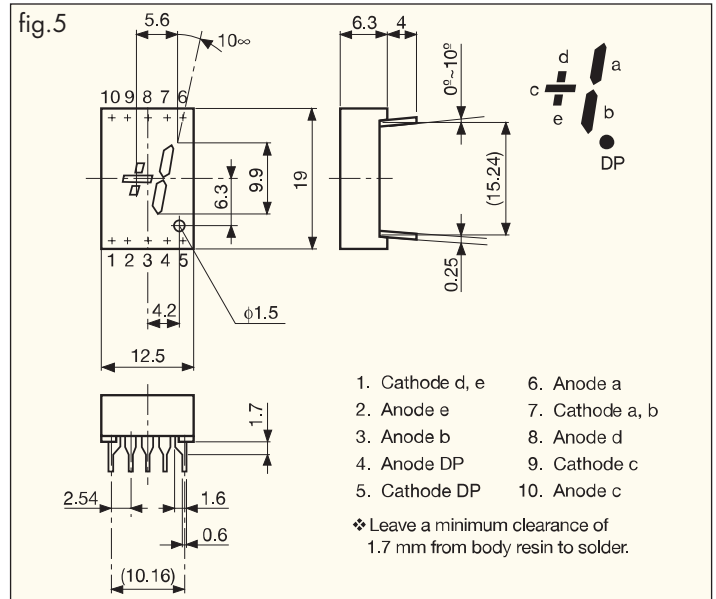
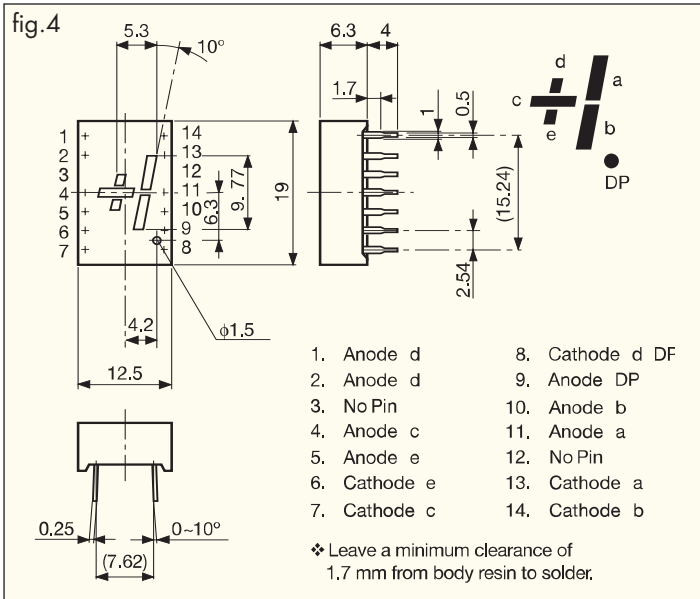

# SUPER BRIGHT LED NUMERIC DISPLAY

## 10mm Type

Ta=25°C

Case Size (WXH)	Shape	Part No.		Emitted Color	Luminous Intensity Iv					fig.
		Anode Common	Cathode Common		MIN.	Rank B TYP.	Rank C MIN.	Rank C TYP.	If	
9.6 X 13.0	Arrow feather type	<b>NAR141S/143S</b>	<b>NKR141S/143S</b>	Red	1.6	3.2	3.2	6.4	10	6
		<b>NAR141SP/143SP</b>	<b>NKG141SP/143SP</b>	Green	0.6	1.2	—	—	10	
		<b>NAA141S/143S</b>	<b>NKA141S/143S</b>	Orange	0.8	1.6	—	—	10	
12.5 X 19.0	Square shape type	<b>NAR141/143</b>	<b>NKR141/143</b>	Red	4	8	8	11	20	7
		<b>NAG141P/143P</b>	<b>NKG141P/143P</b>	Green	1	2	—	—	20	
		<b>NAA141/143</b>	<b>NKA141/143</b>	Orange	3	6	—	—	20	
12.5 X 19.0	Arrow feather type	<b>NAR145/147</b>	<b>NKR145/147</b>	Red	3.2	6.4	6.4	8.8	20	8
		<b>NAG145P/147P</b>	<b>NKG145P/147P</b>	Green	0.8	1.6	—	—	20	
		<b>NAA145/147</b>	<b>NKA145/147</b>	Orange	2.4	4.8	—	—	20	
mm		Units			mcd					mA

## Package Dimensions

unit : mm

Tolerance : ±0.25mm

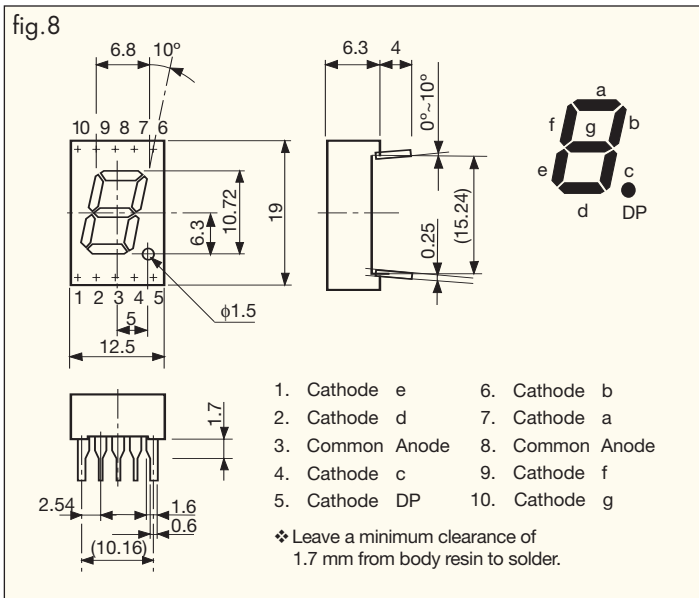
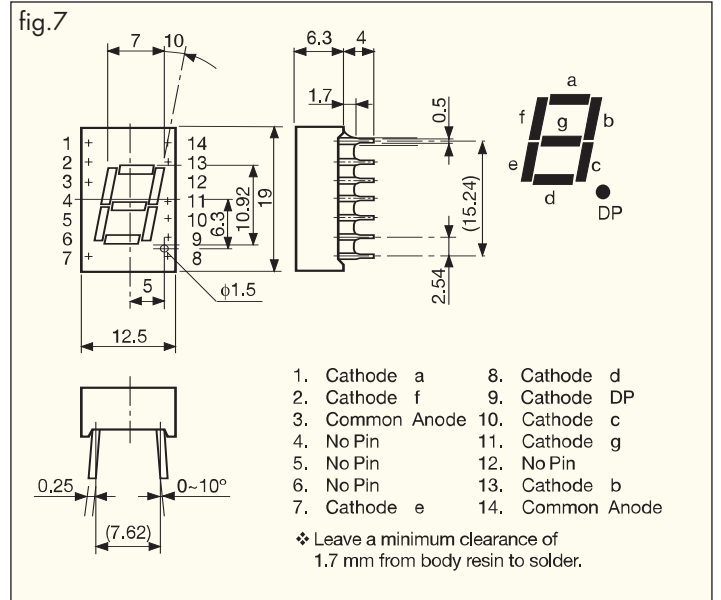
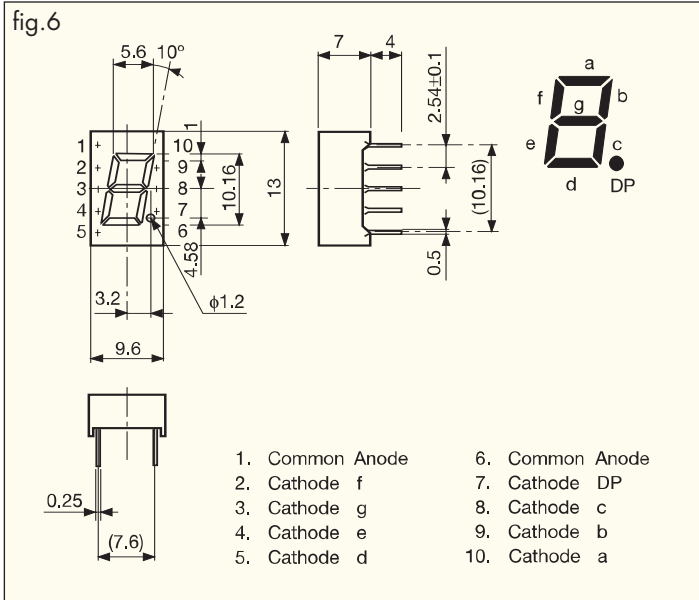



● Common cathode types shown in fig. 6, 7, and 8 have a reverse polarity.

# SUPER BRIGHT LED NUMERIC DISPLAY

## 10mm Type

Ta=25°C

Case Size (WXH)	Shape	Part No.		Emitted Color	Luminous Intensity Iv					fig.
		Anode Common	Cathode Common		Rank B		Rank C		I <sub>F</sub>	
25.2 X 19.0	Square shape type 	<b>NAR241/243</b>	<b>NKR241/243</b>	Red	4	8	8	11	20	9
		<b>NAG241P/243P</b>	<b>NKG241P/243P</b>	Green	1	2	—	—	20	
		<b>NAA241/243</b>	<b>NKA241/243</b>	Orange	3	6	—	—	20	
25.2 X 19.0	Arrow feather type 	<b>NAR245/247</b>	<b>NKR245/247</b>	Red	3.2	6.4	6.4	8.8	20	10
		<b>NAG245P/247P</b>	<b>NKG245P/247P</b>	Green	0.8	1.6	—	—	20	
		<b>NAA245/247</b>	<b>NKA245/247</b>	Orange	2.4	4.8	—	—	20	
mm		Units				mcd			mA	

## Package Dimensions

unit : mm

Tolerance : ±0.25mm

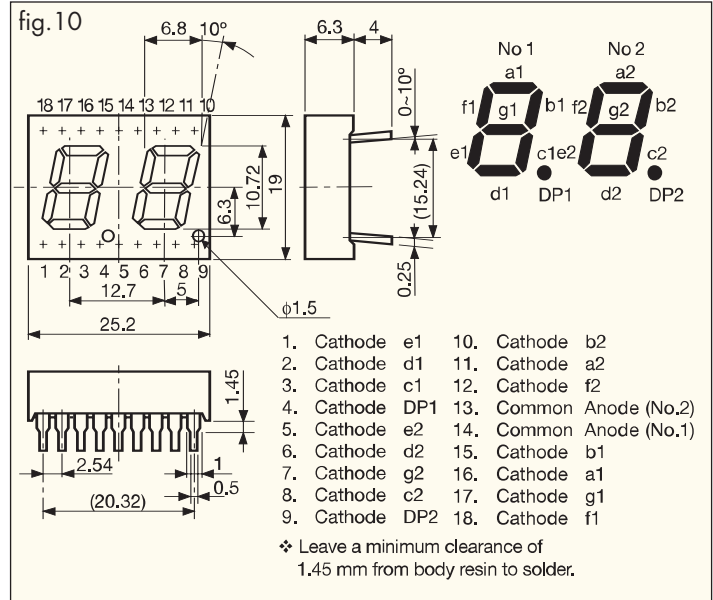
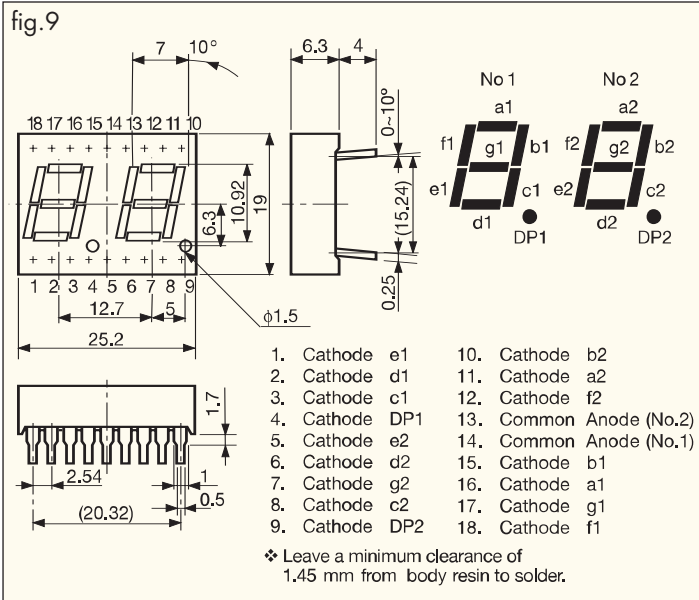

● Common cathode types shown in fig. 9 and 10 have a reverse polarity.

# SUPER BRIGHT LED NUMERIC DISPLAY

## 15mm Type

Ta=25°C

Case Size (WXH)	Shape	Part No.		Emitted Color	Luminous Intensity Iv					fig.
		Anode Common	Cathode Common		MIN.	Rank B TYP.	MIN.	Rank C TYP.	If	
12.5 X 19.0	Arrow feather type 	<b>NSR161/163</b>		Red	6	12	12	15	20	11
		<b>NSG161P/163P</b>		Green	2	4	—	—	20	
		<b>NSA161/163</b>		Orange	4	8	—	—	20	
12.5 X 19.0	Arrow feather type 	<b>NAR161/163</b>	<b>NKR161/163</b>	Red	6	12	12	15	20	12
		<b>NAG161P/163P</b>	<b>NKG161P/163P</b>	Green	2	4	—	—	20	
		<b>NAA161/163</b>	<b>NKA161/163</b>	Orange	4	8	—	—	20	
25.2 X 19.0	Arrow feather type 	<b>NAR261/263</b>	<b>NKR261/263</b>	Red	6	12	12	15	20	13
		<b>NAG261P/263P</b>	<b>NKG261P/263P</b>	Green	2	4	—	—	20	
		<b>NAA261/263</b>	<b>NKA261/263</b>	Orange	4	8	—	—	20	
mm		Units			mcd					mA

## Package Dimensions

unit : mm

Tolerance : ±0.25mm

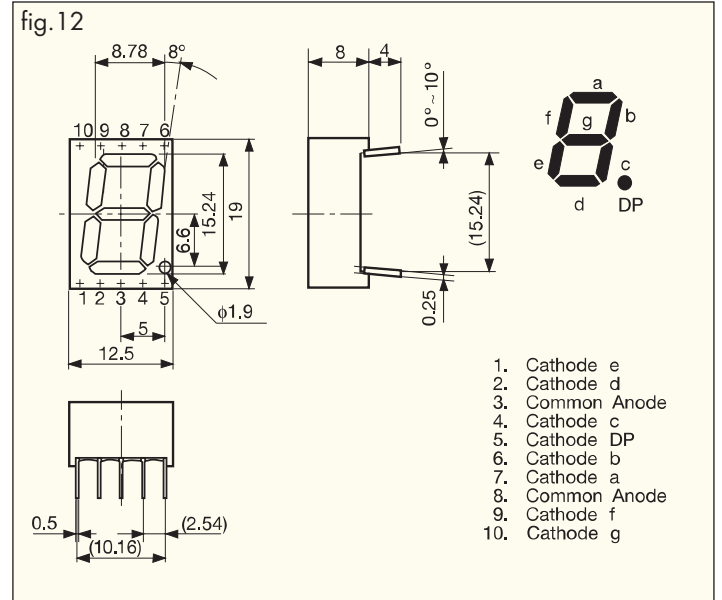
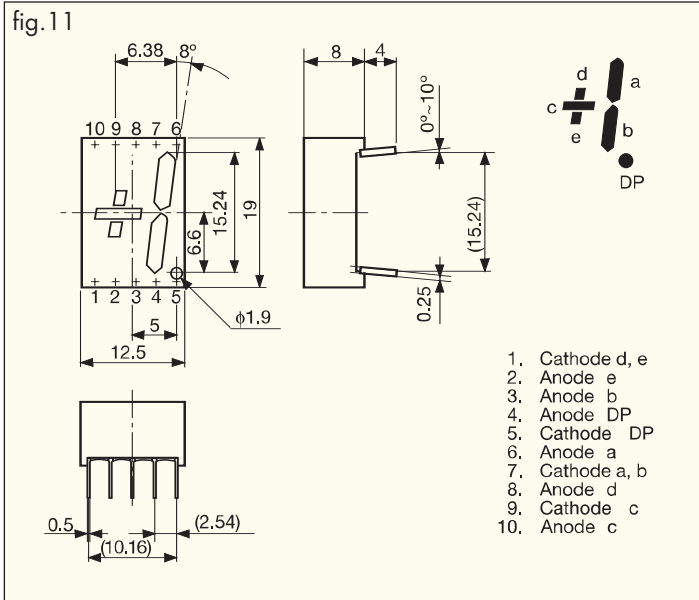

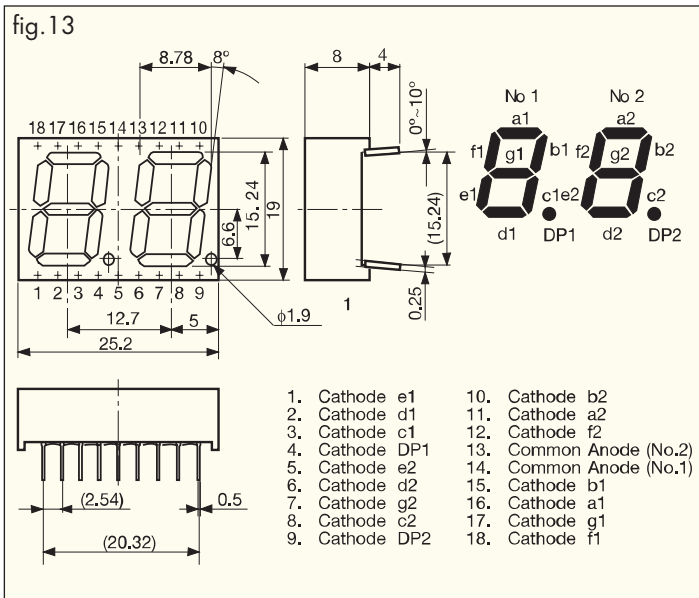

● Common cathode types shown in fig. 12 and 13 have a reverse polarity.



# SUPER BRIGHT LED NUMERIC DISPLAY

## 25mm Type

Ta=25°C

Case Size (WXH)	Shape	Part No.		Emitted Color	Luminous Intensity Iv					fig.
		Anode Common	Cathode Common		Rank B		Rank C		If	
					MIN.	TYP.	MIN.	TYP.		
22.8 X 33.0	Square shape type 	<b>NSR101/103</b>		Red	10	20	20	25	20	14
		<b>NSG101P/103P</b>		Green	4	8	—	—	20	
		<b>NSA101/103</b>		Orange	8	16	—	—	20	
22.8 X 33.0	Square shape type 	<b>NAR101/103</b>	<b>NKR101/103</b>	Red	10	20	20	25	20	15
		<b>NAG101P/103P</b>	<b>NKG101P/103P</b>	Green	4	8	—	—	20	
		<b>NAA101/103</b>	<b>NKA101/103</b>	Orange	8	16	—	—	20	
22.8 X 33.0	Arrow feather type 	<b>NAR105/107</b>	<b>NKR105/107</b>	Red	10	20	20	25	20	16
		<b>NAG105P/107P</b>	<b>NKG105P/107P</b>	Green	4	8	—	—	20	
		<b>NAA105/107</b>	<b>NKA105/107</b>	Orange	8	16	—	—	20	
mm		Units			mcd					mA

## Package Dimensions

unit : mm

Tolerance : ±0.25mm

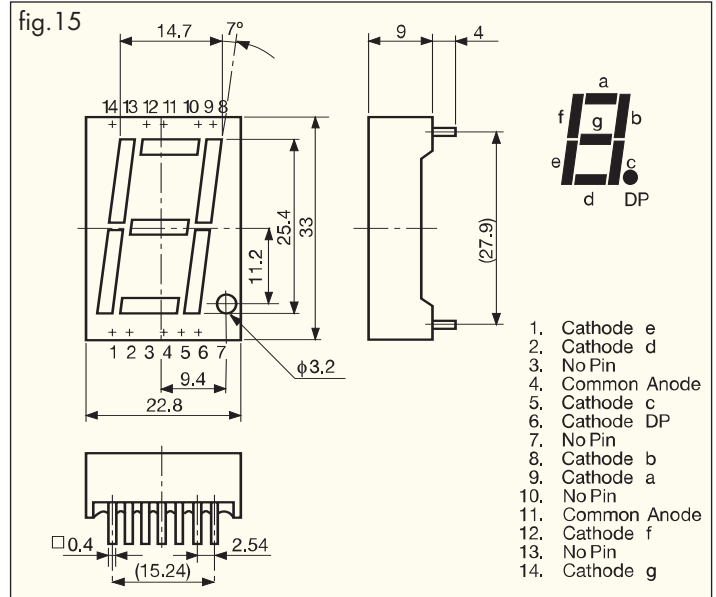
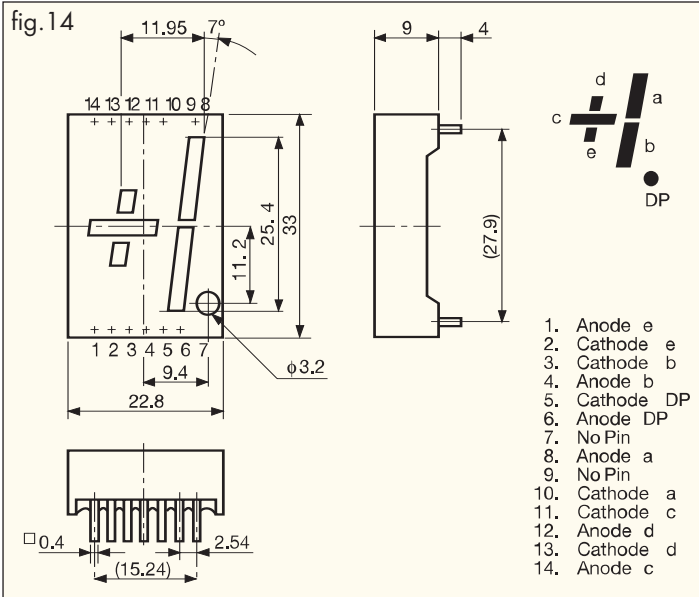

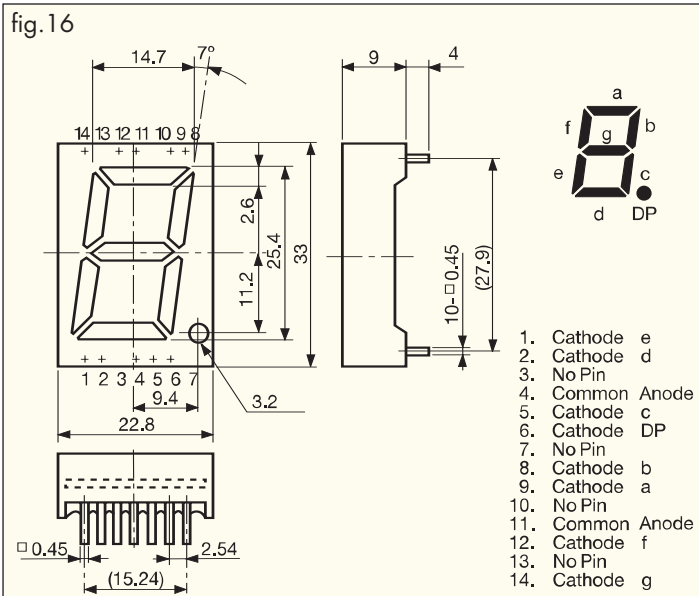

● Common cathode types shown in fig. 15 and 16 have a reverse polarity.



# SUPER BRIGHT LED NUMERIC DISPLAY

## Bi-color LED Numeric Displays 10/15/25mm TYPE

Ta=25°C

Case Size (WXH)	Shape	Part No.		Emitted Color	Luminous Intensity Iv			fig.
		Anode Common	Cathode Common		MIN.	TYP.	I <sub>F</sub>	
10.0 X 19.0	Arrow feather type 	<b>NARG141/143</b>	<b>NKRG141/143</b>	Red	1.2	2.4	10	17
				Green	1.2	2.4	10	
12.5 X 19.0	Arrow feather type 	<b>NARG161/163</b>	<b>NKRG161/163</b>	Red	1.2	2.4	10	18
				Green	1.2	2.4	10	
22.8 X 33.0	Arrow feather type 	<b>NARG105/107</b>		Red	2	4	10	19
				Green	2	4	10	
mm		Units			mcd		mA	

### Package Dimensions

unit : mm

Tolerance : ±0.25mm

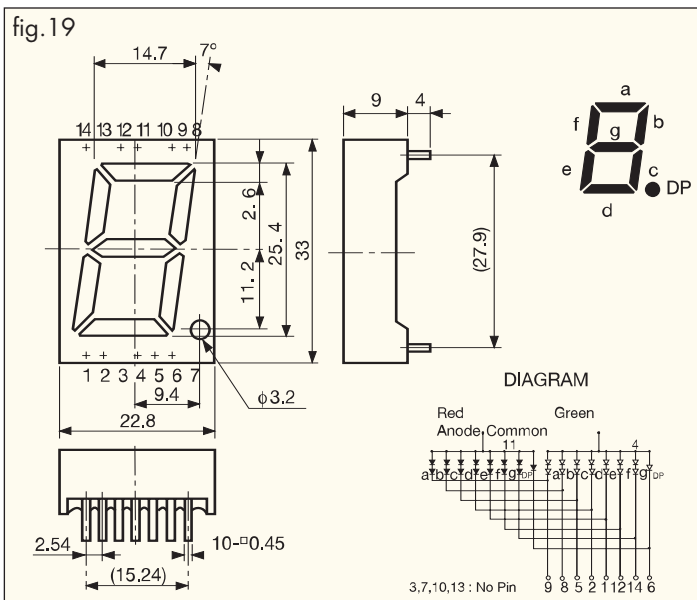
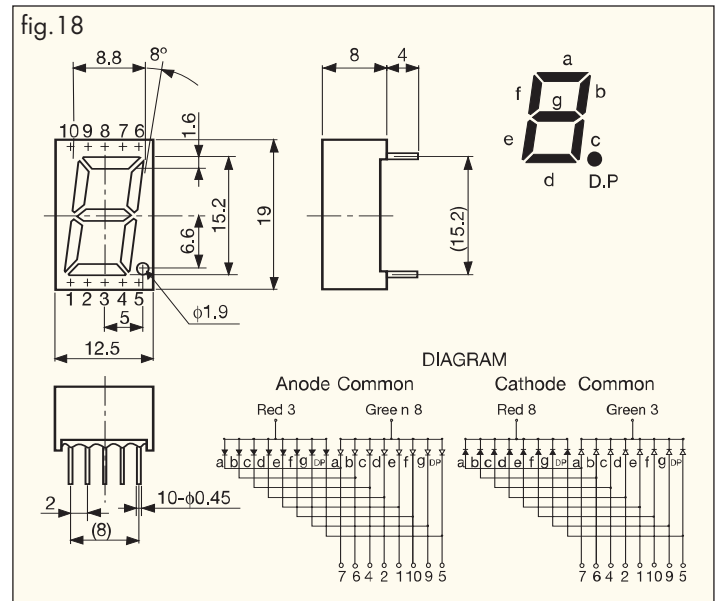
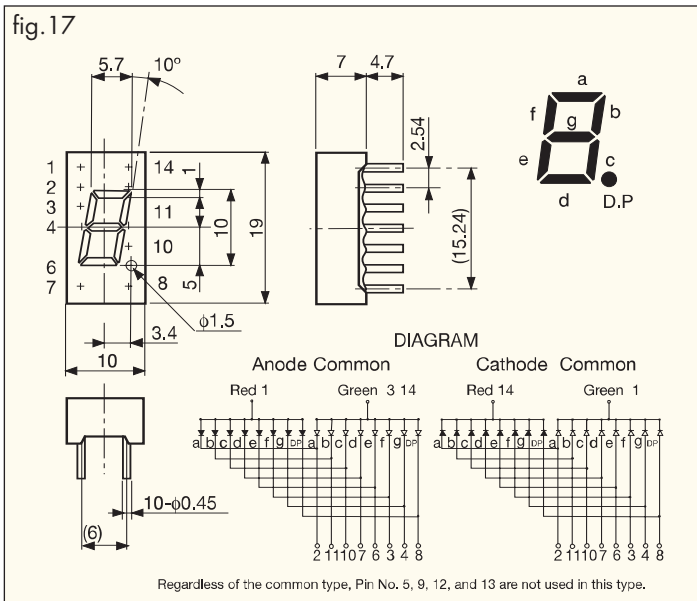

# ALPHA-NUMERIC LED DISPLAY

## Description of Part Number



## Characteristics by Color

Ta=25°C

Size	Part No.	Material (Emitted color)	♦	Absolute Maximum Ratings						Electro-Optical Characteristics						Derating Δ If	
				Power Dissipation Pd	Forward current If	Peak Forward current IfM	Reverse Voltage Vr	Operating Temp. Topr	Storage Temp. Tstg	Forward Voltage Vf		Reverse Current Ir		Wavelength λp			
										TYP.	MAX.	If	MAX.	Vr	TYP.	Vr	
25	AAR	GaAlAs (Red)	1	50	25	100	4	-20~+85	-20~+100	1.7	2.0	20	100	4	660	20	0.33
			2	100						3.4	4.0		8				
	AAA	GaAsP (Orange)	1	60	25	100	4	-20~+85	-20~+100	2.2	2.5	20	100	4	605	20	0.33
			2	120						4.4	5.0		8				
50	AAR	GaAlAs (Red)	4	200	40	200	8	-30~+70	-30~+80	1.7	2.0	40	20	8	660	40	0.66
			2	100						20	100		20				
	AAA	GaAsP (Orange)	4	200	40	200	8	-30~+70	-30~+80	2.1	2.5	40	20	8	605	40	0.66
			2	100						20	100		20				
mm	Units			mW	mA	mA	V	°C		V		mA	µA	V	nm	mA	mA/°C

## Characteristics by Shape (25/50 mm TYPE)

Ta=25°C

Case Size (WXH)	Shape	Part No.	Emitted Color	♦	Luminous Intensity Iv					fig.
					Rank B		Rank C		If	
		Anode Common			MIN.	TYP.	MIN.	TYP.		
22.8 X 33		AAR101	Red	1	6	12	12	15	20	20
				2	12	24	24	30		
		AAA101	Orange	1	2	4	—	—	20	
				2	4	8	—	—		
40 X 74		AAR121	Red		4	6	—	—	40♦	21
				AAA121	Orange		2	3	—	
		Units						mcd		

♦ 20 mA/segment is for segments A,B,E,F,U and P.

## Package Dimensions

unit : mm

Tolerance : ±0.25mm

