

# Harmony™ XB6/ZB6 16 mm push buttons

Catalog  
2011



**Schneider**  
Electric™



# Harmony™ XB6/ZB6 16 mm push buttons

---

<b>Introduction</b> .....	<b>4</b>
<b>Product range</b> .....	<b>5</b>
<b>Specifications</b> .....	<b>10</b>
<b>Assembled products</b> .....	<b>12</b>
<b>References</b>	
□ <b>Complete units</b> .....	<b>15</b>
□ <b>Electrical components</b> .....	<b>18</b>
□ <b>Illuminated operators</b> .....	<b>19</b>
□ <b>Non-illuminated operators and selector switches</b> .....	<b>20</b>
□ <b>Keyed selector switches</b> .....	<b>21</b>
□ <b>Accessories</b> .....	<b>22</b>
<b>Dimensions</b> .....	<b>25</b>
<b>Index</b> .....	<b>31</b>

# Harmony™ XB6/ZB6 16 mm push buttons



## Introduction

Schneider Electric's Harmony™ XB6/ZB6 16 mm push buttons, pilot lights and selector switches—with plastic bezels—are specifically designed for applications where the surface area is restricted. The IP 65 degree of protection enables these products to be used in all types of applications.

## Applications:

- Industry: Small finishing machines. Local and remote control panels.
- Buildings: Control boards, surveillance rooms, alarms.
- Tertiary: Laboratories and medical instrumentation. Transport. Small electronic equipment.

## Product features:

- Circular, square or rectangular heads
- Tags for quick connectors, solder connection or printed circuit board pins
- Degree of protection: IP 65
- Certifications: CE, UL, CSA, CCC

## Contact functions:

- Push buttons with spring return and latching
- Selector switches and key switches, 2 or 3 positions
- Trigger action
- Emergency stop

## Light functions:

- LED pilot lights (Protected LED), neon and incandescent bulbs

## Combined functions (contact + light):

- Illuminated push buttons, flush push, spring return and latching
- Illuminated selector switches

## Description

The 16 mm range of double insulated control and signaling units is comprised of:

**Complete units**  
XB6 push buttons,  
switches and pilot lights

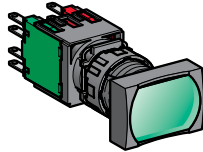

XB6D with rectangular head

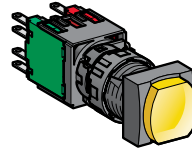

XB6C with square head

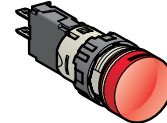

XB6A with circular head

**Sub-assemblies for user assembly**  
ZB6 push buttons,  
switches and pilot lights  
Body + head sub-assemblies

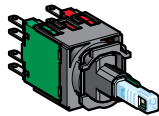

ZB6D with rectangular head



ZB6C with square head



ZB6A with circular head

**ZB component parts and accessories**  
Any of the push buttons,  
switches or pilot lights in the  
range may be adapted by  
replacing certain component  
parts, such as:

### For heads

- Caps or lenses
- Pre-printed legends
- Link enabling operation of the 3<sup>rd</sup> contact (cannot be fitted on illuminated push buttons)

### For bodies

- LED, incandescent and neon bulbs
- N/C or N/O contact blocks, max. 3 contacts per block, with quick connector or for printed circuit board
- Silver or gold flashed N/C or N/O contact blocks

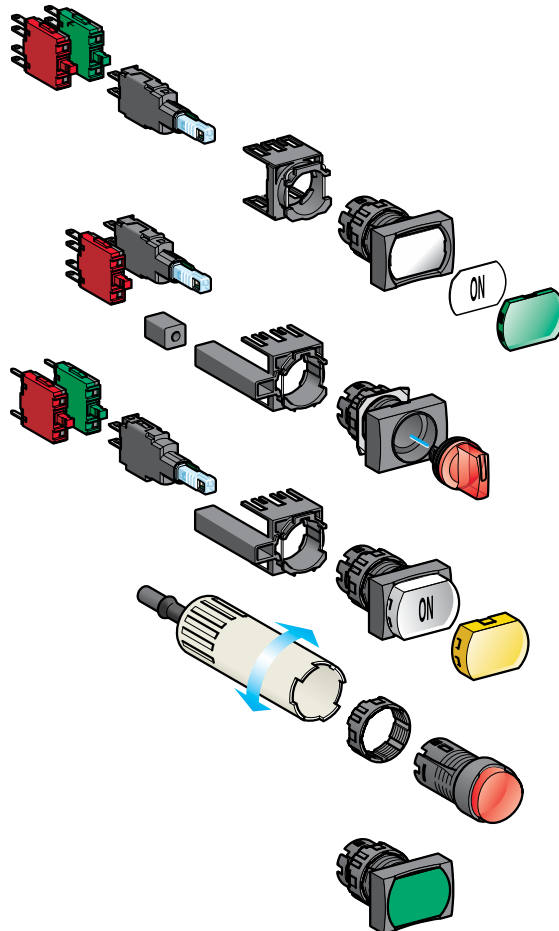

**Complete units**

**Combined functions (contact + signaling)**

Illuminated push buttons with rectangular, square or circular head

Head colors

Illuminated push buttons

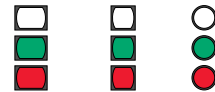
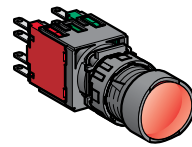
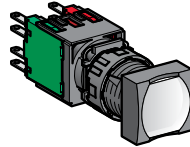
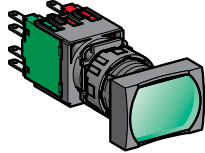

**Protected LED**

Full guard with integral LED, spring return

XB6DW●●●●  
page 15

XB6CW●●●●  
page 15

XB6AW●●●●  
page 15

**Protected LED**

Full guard with integral LED, maintained

XB6DF●●●●  
page 15

XB6CF●●●●  
page 15

XB6AF●●●●  
page 15

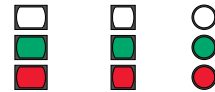
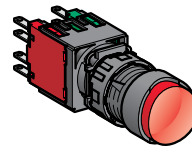
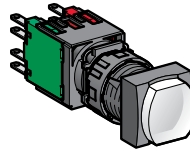
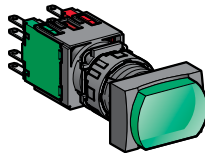

**Protected LED**

No guard with integral LED, spring return

XB6DE●●●●  
page 15

XB6CE●●●●  
page 15

XB6AE●●●●  
page 15

**Signaling functions**

Pilot lights with rectangular, square or circular head

Head colors

Pilot lights

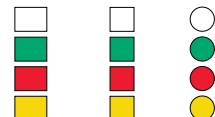
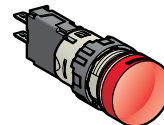
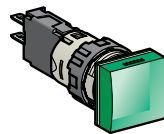
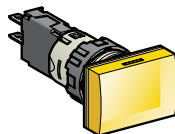

**Protected LED**

With integral LED

XB6DV●●●  
page 16

XB6CV●●●  
page 16

XB6AV●●●  
page 16

**Complete units  
(continued)**

**Contact functions**

Push buttons,  
spring return

Push buttons with rectangular, square or circular head

Head colors

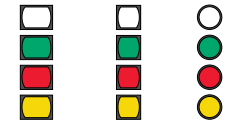
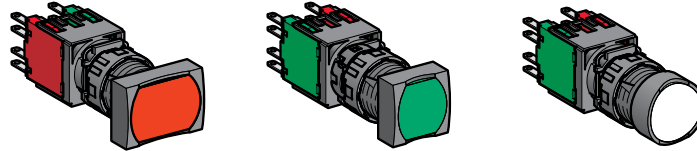

Full guard

**XB6DA●●●**  
page 16

**XB6CA●●●**  
page 16

**XB6AA●●●**  
page 16

Mushroom head,  
Emergency stop,  
maintained and trigger  
action

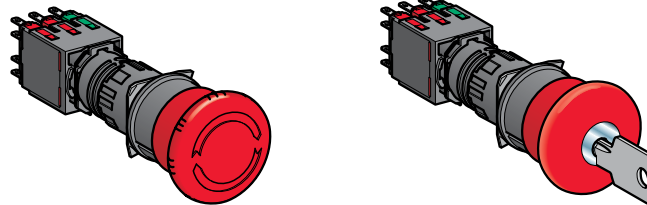

Turn to release (EN/ISO 13850: 2006)

**XB6AS834●B**  
page 13

Key release (EN/ISO 13850: 2006)

**XB6AS934●B**  
page 13

Selector switches  
and key switches

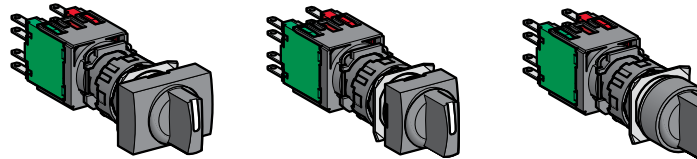

Standard handle operator

**XB6DD●●●**  
page 17

**XB6CD●●●**  
page 17

**XB6AD●●●**  
page 17

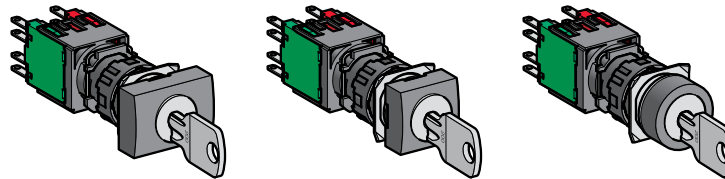







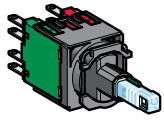
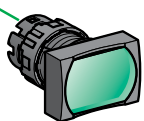

Key switches

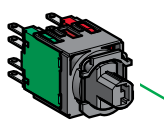
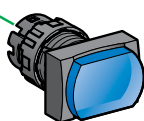
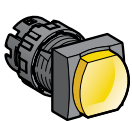
**XB6DG●●●**  
page 17

**XB6CG●●●**  
page 17

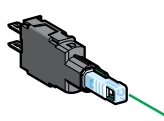
**XB6AG●●●**  
page 17

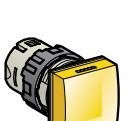
Illuminated units for user assembly	Combined functions (contact + signaling)		
Body sub-assemblies	Head sub-assemblies, rectangular, square or circular		Head colors
For illuminated push buttons and selector switches	With integral LED		
 <p><b>Quick connector</b> ZB6ZB●●B page 18</p>	   <p><b>Full guard, spring return</b> ZB6DW● page 19    ZB6CW● page 19    ZB6AW● page 19</p> <p><b>Full guard, maintained</b> ZB6DF●●●B page 19    ZB6CF●●●B page 19    ZB6AF●●●B page 19</p>		
Direct supply for incandescent bulb	No guard, spring return		
 <p><b>Quick connector</b> ZB6ZH●●B page 18</p>	   <p>ZB6DE● page 19    ZB6CE● page 19    ZB6AE● page 19</p>		

Signaling functions			
Body sub-assemblies	Head sub-assemblies, rectangular, square or circular		Head colors
For pilot lights	With integral LED		
 <p><b>Quick connector</b> ZB6E●●B page 18</p>	   <p>ZB6DV● page 19    ZB6CV● page 19    ZB6AV● page 19</p>		
	Direct supply for incandescent bulb or with resistor		
 <p><b>Quick connector</b> ZB6E●0B page 18</p>			



# Harmony™ XB6/ZB6 16 mm push buttons

**Non illuminated units for user assembly**

For push buttons

For mushroom head push buttons and Emergency stop heads

For selector switches and key switches

**Contact functions**

Body sub-assemblies

Direct supply for incandescent bulb

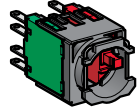

Quick connector  
ZB6Z●B  
page 18

Head sub-assemblies, rectangular, square or circular

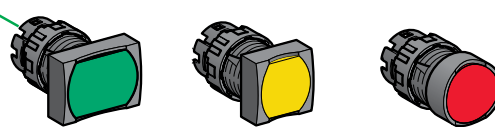

Full guard, spring return  
ZB6DA●  
page 20

ZB6CA●  
page 20

ZB6AA●  
page 20

Head colors

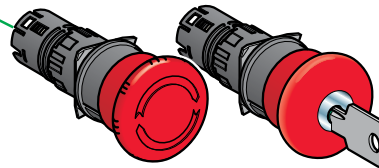
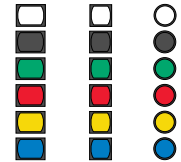

Maintained, trigger action 30 mm (EN/ISO 13850: 2006)

Turn to release  
ZB6AS834  
page 20

Key release  
ZB6AS934  
page 20

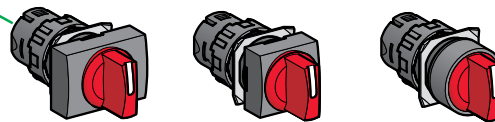

Standard handle operator  
ZB6DD●●  
page 20

ZB6CD●●  
page 20

ZB6AD●●  
page 20

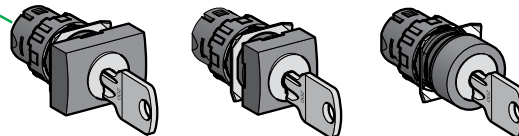



Key switches  
ZB6DG●●  
page 21

ZB6CG●●  
page 21

ZB6AG●●  
page 21

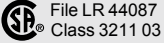

# Harmony™ XB6/ZB6 16 mm push buttons

Environmental specifications			
<b>Conforming to standards</b>	 		IEC 60947-1, IEC 60947-5-1, IEC 60947-5-4, EN 60947-5-1, JIS C 4520 and 852, UL 508, CSA C22.2 No. 14, RoHS compliant (Reduction of Hazardous Substances)
<b>Product certifications</b>	 		UL, CSA ASE, BV, JIS, RINA, LROS, DNV, GL: pending
<b>Protective treatment standard version</b>			"TC"
<b>Ambient air temperature around the device</b>	Storage	°C (°F)	- 40 to +70 (- 40 to +158)
	Operation	°C (°F)	- 25 to +70 (-13 to +158)
<b>Vibration resistance</b>	Conforming to IEC 60068-2-6		(2 to 500 Hz) 3 mm peak to peak or 5 gn
<b>Shock resistance</b>	Conforming to IEC 60068-2-27		Half sine wave 18 ms, 30 gn Half sine wave 11 ms, 50 gn
<b>Electric shock protection</b>	Conforming to IEC 60536 & NF C 20-030		Class II
<b>Degree of protection</b>	Conforming to IEC 60529 & NF C 20-010 Conforming to UL 50 & CSA C22.2 No. 94		IP 65 Type 1, 4, 4X and 12 (not for key selector switches)
<b>Mechanical durability (in operating cycles)</b>	Spring return push buttons		2 million
	Maintained push buttons		300,000
	Key operated selector switches		200,000
	Handle operated selector switches		500,000
<b>Mounting positions</b>			All
Electrical specifications of LED pilot lights			
<b>Voltage limits</b>			6 - 30 Vac/Vdc
<b>Current draw</b>		<b>mA</b>	15
<b>Surge withstand</b>	Conforming to IEC 61000-4-5	<b>kV</b>	2/1
<b>Resistance to fast transients</b>	Conforming to IEC 61000-4-4	<b>kV</b>	2
<b>Resistance to electromagnetic fields</b>	Conforming to IEC 61000-4-3	<b>V/m</b>	10
<b>Resistance to electrostatic discharges</b>	Conforming to IEC 61000-4-2	<b>kV</b>	8/6
<b>Electromagnetic emission</b>	Conforming to IEC 55011		Class B
<b>Service life</b>	At nominal voltage and 25 °C ambient		100,000 hrs

Electrical specifications of contacts			
Rated operational specifications	AC-15		B300, Ue = 240 Vac and Ie = 1.5 A or Ue 120 Vac and Ie = 3 A
	DC-13		R300, Ue = 250 Vdc and Ie = 0.1 A or Ue = 125 Vdc and Ie = 0.22 A
Rated insulation voltage	Conforming to IEC 60947-1		Ui = 250 V Degree of pollution 3 (Except pilot lights with incandescent or neon bulb: degree of pollution 2)
Rated impulse withstand voltage	Conforming to EN/IEC 60947-1	kV	Uimp = 4
Contact material	Normal environment and usage		Silver alloy
	Chemically corrosive environment or infrequent operation		Gold
Contact operation	N/C or N/O		Slow break, with indication of change of state by the tactile feedback on push and audibility
Differential travel of contacts	With push button head	in (mm)	Changing N/C state: 0.04 (1.0) Changing N/O state: 0.08 (2.0) Total travel: 0.14 (3.5)
Operating force	N/C contact	lbf (N)	0.56 (2.5)
	N/O contact	lbf (N)	0.36 (1.6)
	Push button head + N/O contact	lbf (N)	0.79 (3.5)
	Push button head + N/C contact	lbf (N)	1.01 (4.5)
Positive operation	Conforming to IEC 60947-5-2	lbf (N)	N/C contact with positive opening operation Positive opening force: 3.38 (15)
Terminal referencing	Conforming to EN 50005 and EN 50013		
Short-circuit protection	Cartridge fuse mounted upstream		6 A gG, 6 A Class CC, Bussman KTK-R
Electrical reliability	Failure rate Conforming to IEC 60947-5-4		With confidence level of 90 %: $\lambda_{30} = 10^{-8}$ 5 V - 1 mA, defect contact voltage drop = 0.5 V
Cabling		in (mm)	By Quick Connectors/Solder tabs 0.11 x 0.02 (2.8 x 0.5) By pins for printed circuit board connection 0.04 x 0.02 (1 x 0.5)
Electrical durability	Conforming to IEC 947-5-1 Appendix C Utilization category AC-15 and DC-13 Operating rate 3600 operating cycles/h Load factor 0.5		1 million operating cycles - 200 VA-230 V

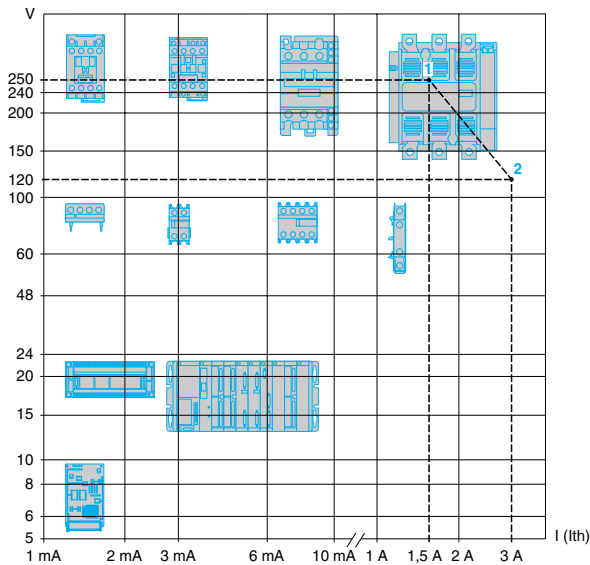

- 1 Switching capacity conforming to EN/IEC 60947-5-1, utilization category AC-15, DC-13  

B300	240 Vac	1.5 A
R300	250 Vdc	0.1 A
- 2 Switching capacity conforming to EN/IEC 60947-5-1, utilization category AC-15, DC-13  



B300	120 Vac	3 A
R300	125 Vdc	0.22 A

# Harmony™ XB6/ZB6 16 mm push buttons













Contact functions and light functions with integral LED















## Illuminated push buttons

Type of head	  	<b>Full guard</b>
Shape of head		rectangular (2)
Degree of protection		IP 65 / Nema 4, 4X, 12 / Class II
Mounting (mm)	panel cut-out	16.2 mm <sup>+0.2</sup> <sub>0</sub>
	mounting centers	24 x 18 with rectangular head, 18 x 18 with square or circular head
Dimensions (mm)	W x H x D (below head)	24 x 18 x 50 with rectangular head, 18 x 18 x 50 with square or circular head
Connection (3)		Tags for 2.8 x 0.5 quick connectors or for soldering

### Type of push: Spring return













			Complete products 12 to 24 V AC/DC	Products for user assembly		
References	white 	N/O	<b>XB6DW1B1B</b>		<b>ZB6Z1B</b>	<b>ZB6DW1</b>
		N/C + N/O	<b>XB6DW1B5B</b>		<b>ZB6Z5B</b>	<b>ZB6DW1</b>
	green 	N/O	<b>XB6DW3B1B</b>		<b>ZB6Z1B</b>	<b>ZB6DW3</b>
		N/C + N/O	<b>XB6DW3B5B</b>		<b>ZB6Z5B</b>	<b>ZB6DW3</b>
	red 	N/C	<b>XB6DW4B2B</b>		<b>ZB6Z2B</b>	<b>ZB6DW4</b>
		N/C + N/O	<b>XB6DW4B5B</b>		<b>ZB6Z5B</b>	<b>ZB6DW4</b>
	yellow 	N/O	–		<b>ZB6Z1B</b>	<b>ZB6DW5</b>
		N/C + N/O	<b>XB6DW5B5B</b>		<b>ZB6Z5B</b>	<b>ZB6DW5</b>

### Type of push: Maintained

References	white 	N/O	–		<b>ZB6Z1B</b>	<b>ZB6DF1</b>
		N/C + N/O	<b>XB6DF1B5B</b>		<b>ZB6Z5B</b>	<b>ZB6DF1</b>
	green 	N/O	<b>XB6DF3B1B</b>		<b>ZB6Z1B</b>	<b>ZB6DF3</b>
		N/C + N/O	<b>XB6DF3B5B</b>		<b>ZB6Z5B</b>	<b>ZB6DF3</b>
	red 	N/C	<b>XB6DF4B2B</b>		<b>ZB6Z2B</b>	<b>ZB6DF4</b>
		N/C + N/O	<b>XB6DF4B5B</b>		<b>ZB6Z5B</b>	<b>ZB6DF4</b>
	yellow 	N/O	–		<b>ZB6Z1B</b>	<b>ZB6DF5</b>
		N/C + N/O	–		<b>ZB6Z5B</b>	<b>ZB6DF5</b>



## Pilot lights

Type of head	  	<b>Smooth lens cap</b>		
Shape of head		rectangular (2)		
References	white 	<b>XB6DV1BB</b>		<b>ZB6DV1</b>
		<b>XB6DV3BB</b>		<b>ZB6DV3</b>
	green 	<b>XB6DV4BB</b>		<b>ZB6DV4</b>
		<b>XB6DV5BB</b>		<b>ZB6DV5</b>
	red 	–		<b>ZB6DV6</b>
	yellow 			
	blue 			

(1) Basic reference, to be completed by the letter **B**, **G** or **M** indicating the required voltage. See **Voltage Table** below.

(2) For products with a square head, replace the letter **D** in the reference by the letter **C** (XB6DW1B1B becomes XB6CW1B1B).

For products with a circular head, replace the letter **D** in the reference by the letter **A** (XB6DW1B1B becomes XB6AW1B1B).

(3) Use ZB6Y010 Plug-in Socket Adapter for 1 x 0.5 pin printed circuit board connection.

### Voltage Table

Voltage	Letter (●)
12 to 24 V AC/DC (15 mA)	B
48 to 120 V AC (25 mA)	G
230 to 240 V AC (25 mA)	M

Product range:  
page 5



Specifications:  
page 10

References:  
page 15

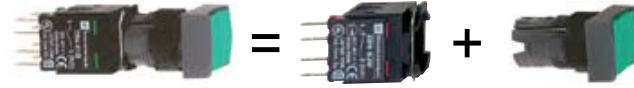





Dimensions:  
page 25

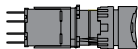

#### Non-illuminated push buttons

Type of head	  	Full guard
Shape of head		rectangular (1)
Degree of protection		IP 65 / Nema 4, 4X, 12 / Class II
Mounting (mm)	panel cut-out	16.2 mm <sup>+0.2</sup> <sub>0</sub>
	mounting centers	24 x 18 with rectangular head, 18 x 18 with square or circular head
Dimensions (mm)	W x H x D (below head)	24 x 18 x 50 with rectangular head, 18 x 18 x 50 with square or circular head
Connection (2)		Tags for 2.8 x 0.5 quick connectors or for soldering

#### Type of push: Spring Return

			Complete products	Products for user assembly	
					
References	white 	N/O	<b>XB6DA11B</b>	<b>ZB6Z1B</b>	<b>ZB6DA1</b>
		N/C + N/O	<b>XB6DA15B</b>	<b>ZB6Z5B</b>	<b>ZB6DA1</b>
	black 	N/O	–	<b>ZB6Z1B</b>	<b>ZB6DA2</b>
		N/C + N/O	<b>XB6DA25B</b>	<b>ZB6Z5B</b>	<b>ZB6DA2</b>
	green 	N/O	<b>XB6DA31B</b>	<b>ZB6Z2B</b>	<b>ZB6DA3</b>
		N/C + N/O	<b>XB6DA35B</b>	<b>ZB6Z5B</b>	<b>ZB6DA3</b>
	red 	N/O	–	<b>ZB6Z1B</b>	<b>ZB6DA4</b>
		N/C + N/O	<b>XB6DA45B</b>	<b>ZB6Z5B</b>	<b>ZB6DA4</b>

(1) For products with a square head, replace the letter D in the reference by the letter C (XB6DA11B becomes XB6CA11B).  
For products with a circular head, replace the letter D in the reference by the letter A (XB6DA11B becomes XB6AA11B).





(2) Alternative connection: 1 x 0.5 pins for printed circuit boards.



#### Mushroom head Emergency stop push buttons (3)

Type of head		Trigger action (EN/ISO 13850: 2006)
Shape of head		cylindrical

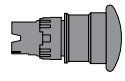
#### Type of push: Turn to release

			Complete products	Products for user assembly		
						
References	red 	2 N/C + 1 N/O	<b>XB6AS8349B</b>	<b>ZB6E2B</b>	<b>ZB6Z5B</b>	<b>ZB6AS834</b>

#### Type of push: Key release, Ronis 200

References	red 	2 N/C + 1 N/O	<b>XB6AS9349B</b>	<b>ZB6E2B</b>	<b>ZB6Z5B</b>	<b>ZB6AS934</b>
------------	---	---------------	-------------------	---------------	---------------	-----------------



(3) Complies with EN418/ISO13850 standards for Emergency Stop push buttons when used with circular Legend Plate ZB6Y7330 (see page 24).

# Harmony™ XB6/ZB6 16 mm push buttons

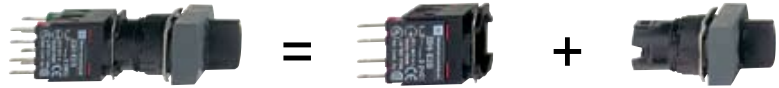

Contact functions and light functions with  
integral LED



## Non-illuminated selector switches and key switches

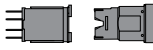

Type of head	  	<b>Black handle</b>
Shape of head		rectangular (1)
Degree of protection		IP 66 / Nema 4, 4X, 12 / Class II
Mounting (mm)	panel cut-out	16.2 mm $^{+0.2}_0$
	mounting centers	24 x 18 with rectangular head, 18 x 18 with square or circular head
Dimensions (mm)	W x H x D (below head)	24 x 18 x 50 with rectangular head, 18 x 18 x 50 with square or circular head
Connection (2)		Tags for 2.8 x 0.5 quick connectors or for soldering

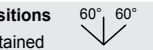
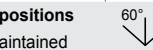
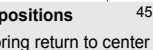
### Type of operator: Black handle

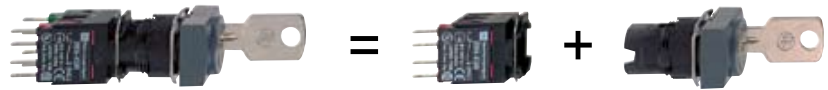
		Complete products	Products for user assembly			
Number and type of positions		 <b>2 positions</b> maintained $60^\circ$	 <b>2 positions</b> maintained $60^\circ$	 <b>2 positions</b> spring return to center $45^\circ$		
References	N/O	<b>XB6DD221B</b>	<b>ZB6Z1B</b>	<b>ZB6DD22</b>	<b>ZB6Z1B</b>	<b>ZB6DD24</b>
	N/C + N/O	<b>XB6DD225B</b>	<b>ZB6Z5B</b>	<b>ZB6DD22</b>	<b>ZB6Z5B</b>	<b>ZB6DD24</b>
Number and type of positions		 <b>3 positions</b> maintained $60^\circ$ $60^\circ$	 <b>3 positions</b> maintained $60^\circ$ $60^\circ$	 <b>3 positions</b> spring return to center $45^\circ$ $45^\circ$		
References	N/O	<b>XB6DD235B</b>	<b>ZB6Z5B</b>	<b>ZB6DD23</b>	<b>ZB6Z5B</b>	<b>ZB6DD25</b>

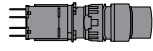
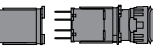
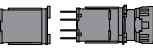

### Type of operator: Ronis key, No. 200

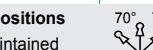
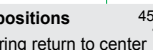
		Complete products	Products for user assembly			
Number and type of positions		 <b>2 positions</b> maintained $70^\circ$	 <b>2 positions</b> maintained $70^\circ$	 <b>2 positions</b> spring return to center $45^\circ$		
References	N/C + N/O	<b>XB6DGC5B</b>	<b>ZB6Z5B</b>	<b>ZB6DGC</b>	<b>ZB6Z5B</b>	<b>ZB6DGB</b>
Number and type of positions		 <b>3 positions</b> maintained $70^\circ$ $70^\circ$	 <b>3 positions</b> maintained $70^\circ$ $70^\circ$	 <b>3 positions</b> spring return to center $45^\circ$ $45^\circ$		
References	N/C + N/O	<b>XB6DGH5B</b>	<b>ZB6Z5B</b>	<b>ZB6DGH</b>	<b>ZB6Z5B</b>	<b>ZB6DGS</b>

(1) For products with a square head, replace the letter **D** in the reference by the letter **C** (XB6DD221B becomes XB6CD221B).  
For products with a circular head, replace the letter **D** in the reference by the letter **A** (XB6DD221B becomes XB6AD221B).  
(2) Alternative connection: 1 x 0.5 pins for printed circuit boards.

### Voltage Table



Voltage	Letter (●)
12 to 24 V AC/DC (15 mA)	B
48 to 120 V AC (25 mA)	G
230 to 240 V AC (25 mA)	M

# Harmony™ XB6/ZB6

## 16 mm push buttons

### Complete units

#### Illuminated Push Buttons (12–24 Vac/Vdc LED included) Complete Units with Quick Connectors/Solder Tabs

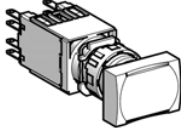
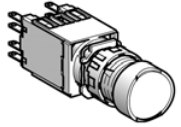
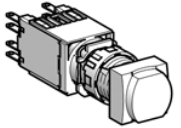
Type of Operator	Type of Contact		Color						
	N.O.	N.C.		Rectangular Reference	Square Reference	Round Reference			
 XB6DW***B	1	—	White	XB6DW1B1B	XB6CW1B1B	XB6AW1B1B			
			Green	XB6DW3B1B	XB6CW3B1B	XB6AW3B1B			
			Yellow	XB6DW5B1B	XB6CW5B1B	XB6AW5B1B			
			Blue	XB6DW6B1B	XB6CW6B1B	XB6AW6B1B			
	—	1	Red	XB6DW4B2B	XB6CW4B2B	XB6AW4B2B			
			1	1	White	XB6DW1B5B	XB6CW1B5B	XB6AW1B5B	
					Green	XB6DW3B5B	XB6CW3B5B	XB6AW3B5B	
					Red	XB6DW4B5B	XB6CW4B5B	XB6AW4B5B	
	Yellow	XB6DW5B5B			XB6CW5B5B	XB6AW5B5B			
	—	1	Blue	XB6DW6B5B	XB6CW6B5B	XB6AW6B5B			
			 XB6AF***B	1	—	White	XB6DF1B1B	XB6CF1B1B	XB6AF1B1B
						Green	XB6DF3B1B	XB6CF3B1B	XB6AF3B1B
Yellow						XB6DF5B1B	XB6CF5B1B	XB6AF5B1B	
Blue	XB6DF6B1B	XB6CF6B1B				XB6AF6B1B			
—	1	Red		XB6DF4B2B	XB6CF4B2B	XB6AF4B2B			
		1		1	White	XB6DF1B5B	XB6CF1B5B	XB6AF1B5B	
					Green	XB6DF3B5B	XB6CF3B5B	XB6AF3B5B	
					Red	XB6DF4B5B	XB6CF4B5B	XB6AF4B5B	
Yellow	XB6DF5B5B				XB6CF5B5B	XB6AF5B5B			
—	1	Blue		XB6DF6B5B	XB6CF6B5B	XB6AF6B5B			
		 XB6CE***B		1	—	White	XB6DE1B1B	XB6CE1B1B	XB6AE1B1B
						Green	XB6DE3B1B	XB6CE3B1B	XB6AE3B1B
			Yellow			XB6DE5B1B	XB6CE5B1B	XB6AE5B1B	
Blue	XB6DE6B1B		XB6CE6B1B			XB6AE6B1B			
—	1		Red	XB6DE4B2B	XB6CE4B2B	XB6AE4B2B			
			1	1	White	XB6DE1B5B	XB6CE1B5B	XB6AE1B5B	
					Green	XB6DE3B5B	XB6CE3B5B	XB6AE3B5B	
					Red	XB6DE4B5B	XB6CE4B5B	XB6AE4B5B	
Yellow	XB6DE5B5B				XB6CE5B5B	XB6AE5B5B			
—	1		Blue	XB6DE6B5B	XB6CE6B5B	XB6AE6B5B			

Illuminated Push Buttons 120 Vac LED are available as Complete Units with Quick Connectors/Solder Tabs. Use 12–24 V table above. Change Voltage Code (2nd B) to "G". Example: XB6DW1B1B (White 24 V, 1 N.O.) becomes XB6DW1G1B. For Legends, see pages 22 and 24.

# Harmony™ XB6/ZB6

## 16 mm push buttons

### Complete units

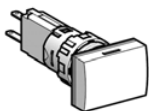

XB6DV\*\*B

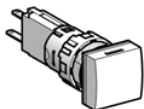

XB6CV\*\*B

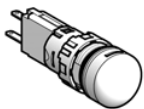

XB6AV\*\*B

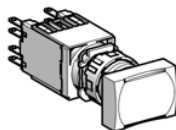

XB6DA\*\*B

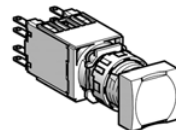

XB6CA\*\*B

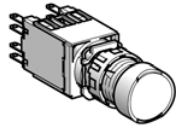

XB6AA\*\*B

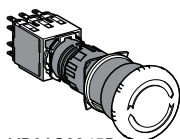

XB6AS8345B

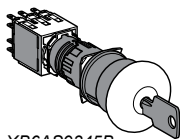

XB6AS9345B



ZB6Y7330

#### Pilot Lights (12–24 Vac/Vdc LED included)

##### Complete Units with Quick Connectors/Solder Tabs

Color			
	Rectangular	Square	Round
	Reference	Reference	Reference
White	XB6DV1BB	XB6CV1BB	XB6AV1BB
Green	XB6DV3BB	XB6CV3BB	XB6AV3BB
Red	XB6DV4BB	XB6CV4BB	XB6AV4BB
Yellow	XB6DV5BB	XB6CV5BB	XB6AV5BB
Blue	XB6DV6BB	XB6CV6BB	XB6AV6BB

#### Pilot Lights (120 Vac LED)

##### Complete Units with Quick Connectors/Solder Tabs

Color			
	Rectangular	Square	Round
	Reference	Reference	Reference
White	XB6DV1GB	XB6CV1GB	XB6AV1GB
Green	XB6DV3GB	XB6CV3GB	XB6AV3GB
Red	XB6DV4GB	XB6CV4GB	XB6AV4GB
Yellow	XB6DV5GB	XB6CV5GB	XB6AV5GB
Blue	XB6DV6GB	XB6CV6GB	XB6AV6GB

#### Push Buttons (Non-Illuminated)

##### Complete Units with Quick Connectors/Solder Tabs

Type of Push	Type of Contact	Color				
			Rectangular	Square	Round	
	N.O.	N.C.	Reference	Reference	Reference	
Flush, spring return	1	—	White	XB6DA11B	XB6CA11B	XB6AA11B
		—	Black	XB6DA21B	XB6CA21B	XB6AA21B
		—	Green	XB6DA31B	XB6CA31B	XB6AA31B
		—	Yellow	XB6DA51B	XB6CA51B	XB6AA51B
		—	Blue	XB6DA61B	XB6CA61B	XB6AA61B
—	1	—	Black	XB6DA22B	XB6CA22B	XB6AA22B
		—	Red	XB6DA42B	XB6CA42B	XB6AA42B
		—	White	XB6DA15B	XB6CA15B	XB6AA15B
1	1	—	Black	XB6DA25B	XB6CA25B	XB6AA25B
		—	Green	XB6DA35B	XB6CA35B	XB6AA35B
		—	Red	XB6DA45B	XB6CA45B	XB6AA45B
		—	Yellow	XB6DA55B	XB6CA55B	XB6AA55B
		—	Blue	XB6DA65B	XB6CA65B	XB6AA65B

#### Trigger Action Emergency Stop Mushroom Head Push Buttons (Color Red) (1)

Shape of Head	Type of Push	Type of Contact		Diameter of Head (mm)	Reference
		N.O.	N.C.		
	Turn-to-release	—	1	30	XB6AS8342B
		1	1	30	XB6AS8345B
	Key release	—	1	30	XB6AS9342B
		1	1	30	XB6AS9345B

(1) Complies with EN418/ISO13850 standards for Emergency Stop push buttons when used with circular Legend Plate ZB6Y7330 (see page 24).

#### Circular Legends, 45 mm

Description	Color	Text	Reference
Circular legends, 45 mm	Yellow	Blank	ZB6Y7001
		Emergency stop	ZB6Y7330

For Legends, pages 22 and 24.



# Harmony™ XB6/ZB6

## 16 mm push buttons

### Complete units

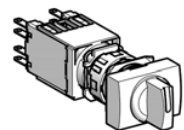

XB6DD\*\*\*B

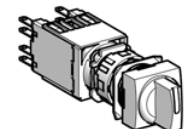

XB6CD\*\*\*B

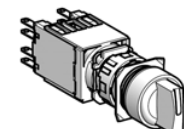

XB6AD\*\*\*B

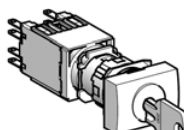

XB6DG\*\*B

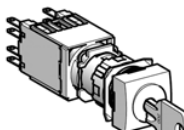

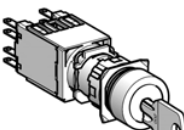

XB6CG\*\*B







XB6AG\*\*B

### Selector Switches (Switching Angle: Handle: 60°, Key: 70°) Complete Units with Quick Connectors/Solder Tabs

Type of Operator	Type of Contact		Number and Type of Positions			
	N.O.	N.C.		Rectangular Reference	Square Reference	Round Reference
Handle	1	—	2-maintained	XB6DD221B	XB6CD221B	XB6AD221B
			2-maintained	XB6DD225B	XB6CD225B	XB6AD225B
	1	1	3-maintained	XB6DD235B	XB6CD235B	XB6AD235B
2	—	3-maintained	XB6DD233B	XB6CD233B	XB6AD233B	



  

Type of Operator	Type of Contact		Number and Type of Positions			
	N.O.	N.C.		Rectangular Reference	Square Reference	Round Reference
Key	1	1	2-maintained	XB6DGC5B	XB6CGC5B	XB6AGC5B
			2-maintained	XB6DGB5B	XB6CGB5B	XB6AGB5B
			3-maintained	XB6DGH5B	XB6CGH5B	XB6AGH5B
	2	—	3-maintained	XB6DGH3B	XB6CGH3B	XB6AGH3B



Note:  Indicates key withdrawal position.

### Selector Switch Sequence

#### 2 Position Selector Switch

		Contact block guide (1)
O	x	1 N.O. (left or right)
x	O	1 N.C. (left or right)
O	x	1 N.O. and 1 N.C.
x	O	1 N.C.

#### 3 Position Selector Switch

			Contact block guide (1)
O	O	x	1 N.O. (left)
x	O	x	2 N.O. wired in <b>parallel</b> (side by side)
x	O	O	1 N.O. (right)
O	x	x	1 N.C. (right)
x	x	O	1 N.C. (left)
O	x	O	2 N.C. wired in <b>series</b> (side by side)

(1) As viewed from the front of the panel.  
For Legends, see pages 22 and 24.

# Harmony™ XB6/ZB6

## 16 mm push buttons

Electrical components

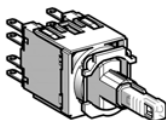

ZB6ZB\*\*B

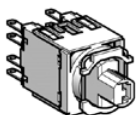

ZB6ZH\*\*B

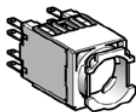

ZB6Z\*B

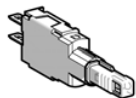

ZB6E\*\*B

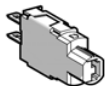

ZB6E\*0B



ZB6E\*B

### Contact Blocks and Light Modules for Illuminated Push Buttons (1)

Description	Supply Voltage	Type of Contact		Color of Light Source	Reference
		N.O.	N.C.		
<b>Quick connectors/solder tabs</b>					
Integral LED (2)	12–24 Vac/Vdc	1	—	White	ZB6ZB11B
				Green	ZB6ZB31B
				Yellow	ZB6ZB51B
				Blue	ZB6ZB61B
				Red	ZB6ZB42B
	—	1	—	Yellow	ZB6ZB52B
				White	ZB6ZB15B
				Green	ZB6ZB35B
				Red	ZB6ZB45B
				Yellow	ZB6ZB55B
	120 Vac	1	—	Blue	ZB6ZB65B
				White	ZB6ZG11B
				Green	ZB6ZG31B
				Yellow	ZB6ZG51B
				Blue	ZB6ZG61B
—	1	1	Red	ZB6ZG42B	
			Yellow	ZB6ZG52B	
			White	ZB6ZG15B	
			Green	ZB6ZG35B	
			Red	ZB6ZG45B	
1	1	1	Yellow	ZB6ZG55B	
			Blue	ZB6ZG65B	
			White	ZB6ZH01B	
			—	ZB6ZH02B	
			—	ZB6ZH05B	
Direct for incandescent bulb (not included) (4)	< 24 Vac/Vdc	1	—	—	ZB6ZH01B
		—	1	—	ZB6ZH02B
		1	1	—	ZB6ZH05B

### Contact Blocks for Push Buttons and Selector Switches

Description	Type of Contact		Reference
	N.O.	N.C.	
<b>Quick connectors/solder tabs</b>			
Contact blocks with mounting base	1	—	ZB6Z1B
	—	1	ZB6Z2B
	2	—	ZB6Z3B
	—	2	ZB6Z4B
	1	1	ZB6Z5B

### Light Modules for Pilot Lights

Description	Supply Voltage	Color of Light Source	Reference
<b>Quick connectors/solder tabs (6)</b>			
Integral LED (3)	12–24 Vac/Vdc	White	ZB6EB1B
		Green	ZB6EB3B
		Red	ZB6EB4B
		Yellow	ZB6EB5B
		Blue	ZB6EB6B
		—	—
	120 Vac	White	ZB6EG1B
		Green	ZB6EG3B
		Red	ZB6EG4B
		Yellow	ZB6EG5B
		Blue	ZB6EG6B
		—	—
With resistor for 95 V neon bulb (not included) (4) (5)	110 Vac	—	ZB6EG0B
	230 Vac	—	ZB6EM0B
Direct supply for 0.6 W max. incandescent bulb (not included) (4)	< 24 Vac/Vdc	—	ZB6EH0B

### Separate Contact Blocks (Maximum of 3 contacts per mounting base.)

Contact Material	For use with mounting base	Type of Contact		Reference
		N.O.	N.C.	
Silver alloy	Quick connectors/solder tabs	1	—	ZB6E1B
		—	1	ZB6E2B
Gold flashed	Quick connectors/solder tabs	1	—	ZB6E1E
		—	1	ZB6E2E

(1) Illuminated selector switches can be assembled by using a contact block/light module assembly in conjunction with a selector switch head, supplied without handle, and a transparent handle. See page 19.

(2) The LED must be the same color as the push button cap.

(3) The LED must be the same color as the lens.

(4) Order bulbs separately. See page 24.

(5) Neon bulb can only be used with a red, yellow, or white cap.

(6) Electrical components with connection by printed circuit board pins are available. See page 24.

# Harmony™ XB6/ZB6

## 16 mm push buttons

### Illuminated operators



ZB6DW\*



ZB6CE\*



ZB6AF\*



ZB6DV\*





ZB6CV\*





ZB6AV\*

#### Heads for Illuminated Push Buttons (To combine with complete bodies and contact blocks, see page 18)

Type of Push	Color			
		Rectangular Reference	Square Reference	Round Reference
Flush, spring return	White	ZB6DW1	ZB6CW1	ZB6AW1
	Green	ZB6DW3	ZB6CW3	ZB6AW3
	Red	ZB6DW4	ZB6CW4	ZB6AW4
	Yellow	ZB6DW5	ZB6CW5	ZB6AW5
	Blue	ZB6DW6	ZB6CW6	ZB6AW6
Flush, maintained	5 colors (1)	ZB6DW9	ZB6CW9	ZB6AW9
	White	ZB6DF1	ZB6CF1	ZB6AF1
	Green	ZB6DF3	ZB6CF3	ZB6AF3
	Red	ZB6DF4	ZB6CF4	ZB6AF4
	Yellow	ZB6DF5	ZB6CF5	ZB6AF5
Extended, spring return	Blue	ZB6DF6	ZB6CF6	ZB6AF6
	5 colors (1)	ZB6DF9	ZB6CF9	ZB6AF9
	White	ZB6DE1	ZB6CE1	ZB6AE1
	Green	ZB6DE3	ZB6CE3	ZB6AE3
	Red	ZB6DE4	ZB6CE4	ZB6AE4
Yellow	ZB6DE5	ZB6CE5	ZB6AE5	
Blue	ZB6DE6	ZB6CE6	ZB6AE6	
5 colors (1)	ZB6DE9	ZB6CE9	ZB6AE9	

(1) Five different color caps included with head (white, green, red, yellow, and blue).

#### Heads for Pilot Lights (To combine with light modules, see page 18)

Color			
	Rectangular Reference	Square Reference	Round Reference
White	ZB6DV1	ZB6CV1	ZB6AV1
Green	ZB6DV3	ZB6CV3	ZB6AV3
Red	ZB6DV4	ZB6CV4	ZB6AV4
Yellow	ZB6DV5	ZB6CV5	ZB6AV5
Blue	ZB6DV6	ZB6CV6	ZB6AV6
5 colors (2)	ZB6DV9	ZB6CV9	ZB6AV9

(2) Five different color caps included with head (white, green, red, yellow, and blue).  
For Legends, see pages 22 and 24.

# Harmony™ XB6/ZB6 16 mm push buttons

Non-illuminated operators and selector switches



ZB6DA•



ZB6CA•



ZB6AA•

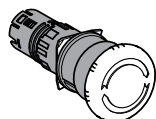

ZB6AS834

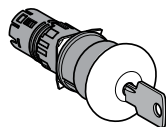

ZB6AS934



ZB6Y7330



ZB6DD••



ZB6CD••



ZB6AD••

## Non-Illuminated Operators – Heads for Push Buttons (To combine with complete bodies and contact blocks, see page 18)

Type of Push	Color			
		Rectangular Reference	Square Reference	Round Reference
Flush, spring return	White	ZB6DA1	ZB6CA1	ZB6AA1
	Black	ZB6DA2	ZB6CA2	ZB6AA2
	Green	ZB6DA3	ZB6CA3	ZB6AA3
	Red	ZB6DA4	ZB6CA4	ZB6AA4
	Yellow	ZB6DA5	ZB6CA5	ZB6AA5
	Blue	ZB6DA6	ZB6CA6	ZB6AA6
	6 colors (1)	ZB6DA9	ZB6CA9	ZB6AA9

(1) Five different color caps included with head (white, green, red, yellow, and blue).

## Non-Illuminated Operators – Mushroom Heads for Trigger Action Push Buttons (30 mm) (2)

Shape of Head	Type of Push	Cap Color	Reference
	Turn-to-release	Red	ZB6AS834
	Key release	Red	ZB6AS934

(2) Complies with EN418/ISO13850 standards for Emergency Stop push buttons when used with circular Legend Plate ZB6Y7330 (see page 24).

## Non-Illuminated Operators – Circular Legends, 45 mm

Description	Color	Text	Reference
Circular legends, 45 mm	Yellow	Blank	ZB6Y7001
		Emergency stop	ZB6Y7330

## Heads for Non-Illuminated Selector Switches (3) (5) (To combine with complete bodies and contact blocks, see page 18)

Number and Type of Positions	Color of Handle			
		Rectangular Reference	Square Reference	Round Reference
Switching angle: maintained positions 60°, spring return positions 45°				
2-maintained	Black	ZB6DD22	ZB6CD22	ZB6AD22
2-maintained	Black	ZB6DD28 (4)	ZB6CD28 (4)	ZB6AD28 (4)
3-maintained	Black	ZB6DD23	ZB6CD23	ZB6AD23
2-spring return to center	Black	ZB6DD24	ZB6CD24	ZB6AD24
3-spring return to center	Black	ZB6DD25	ZB6CD25	ZB6AD25
3-spring return from right to center	Black	ZB6DD26	ZB6CD26	ZB6AD26
3-spring return from left to center	Black	ZB6DD27	ZB6CD27	ZB6AD27

(3) For bodies with 2 contact blocks, maximum.



(4) Switching angle: maintained positions 90°.

(5) See selector switch sequence charts on page 17.

For Legends, see pages 22 and 24.

# Harmony™ XB6/ZB6 16 mm push buttons Keyed selector switches

## Heads for Ronis Key Operated Selector Switches (1) (To combine with complete bodies and contact blocks, see page 18)

Number and Type of Positions	Key Withdrawal			
		Reference	Reference	Reference
<b>Switching angle: maintained positions 70°, spring return positions 45°</b>				
<b>2-maintained</b>	 Right-hand position	ZB6DGA	ZB6CGA	ZB6AGA
	 Center position	ZB6DGB	ZB6CGB	ZB6AGB
	 Both positions	ZB6DGC	ZB6CGC	ZB6AGC
<b>2-spring return from right to center</b>	 Center position	ZB6DGL	ZB6CGL	ZB6AGL
<b>3-maintained</b>	 Left-hand position	ZB6DGD	ZB6CGD	ZB6AGD
	 Center position	ZB6DGE	ZB6CGE	ZB6AGE
	 Left-hand and center positions	ZB6DGF	ZB6CGF	ZB6AGF
	 Right-hand position	ZB6DGG	ZB6CGG	ZB6AGG
	 All 3 positions	ZB6DGH	ZB6CGH	ZB6AGH
	 Left-hand and right-hand positions	ZB6DGJ	ZB6CGJ	ZB6AGJ
	 Right-hand and center positions	ZB6DGK	ZB6CGK	ZB6AGK
<b>3-spring return from right to center</b>	 Left-hand position	ZB6DQJ	ZB6CQJ	ZB6AQQ
	 Center position	ZB6DGR	ZB6CGR	ZB6AGR
	 Left-hand and center positions	ZB6DGS	ZB6CGS	ZB6AGS
<b>3-spring return to center</b>	 Center position	ZB6DGT	ZB6CGT	ZB6AGT

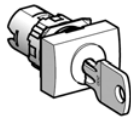

ZB6DG•

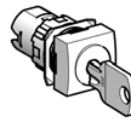

ZB6CG•

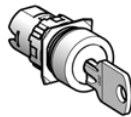



ZB6AG•

Note:  Indicates key withdrawal position.



(1) Ronis 200 key standard. Other keys available, refer to Catalog 9001CT0001.

## Selector Switch Sequence (using contact block assemblies, page 18)

### 2 Position Selector Switch

		Contact block guide (2)
O	x	1 N.O. (left or right)
x	O	1 N.C. (left or right)
O	x	1 N.O. and 1 N.C.
x	O	

### 3 Position Selector Switch

			Contact block guide (2)
O	O	x	1 N.O. (left)
x	O	x	2 N.O. wired in <b>parallel</b> (side by side)
x	O	O	1 N.O. (right)
O	x	x	1 N.C. (right)
x	x	O	1 N.C. (left)
O	x	O	2 N.C. wired in <b>series</b> (side by side)

(2) As viewed from the front of the panel.  
For Legends, see pages 22 and 24.

# Harmony™ XB6/ZB6

## 16 mm push buttons

### Accessories

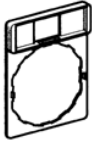

ZB6YD20



ZB6Y2178



ZB6Y2304

#### Standard Legend Plate (24 x 28 mm) for 8 x 21 mm Legend

Description	Background Color of Legend	Reference
Without legend insert	—	ZB6YD20
With blank legend insert	White or yellow	ZB6YD21
	Black or red	ZB6YD22

#### 8 x 21 mm Marked Legends (for 24 x 28 mm legend holder ZB6YD20)

Color	Marking	Reference	
White Text	International	O-I	ZB6Y2178
		I-II	ZB6Y2179
		I-O-II	ZB6Y2186
		← O →	ZB6Y2190
Red Background (Stop and Fault) Black Background (all others)	English	HAND-O-AUTO	ZB6Y2387
		CLOSE	ZB6Y2314
		DOWN	ZB6Y2308
		FORWARD	ZB6Y2305
		FAULT	ZB6Y2334
		LEFT	ZB6Y2310
		OFF	ZB6Y2312
		ON	ZB6Y2303
		OPEN	ZB6Y2313
		RESET	ZB6Y2323
		REVERSE	ZB6Y2306
		RIGHT	ZB6Y2309
		RUN	ZB6Y2311
		STOP	ZB6Y2304
		UP	ZB6Y2307

# Harmony™ XB6/ZB6

## 16 mm push buttons

### Accessories



ZB6YD•10



ZB6YC•10



ZB6YA•10



ZB6YD•17



ZB6YD•19



ZB6YC•19



ZB6YA•19

#### Push Button Caps—Marked

Ink Marking Color: White on colored cap Black on white cap		Color	Rectangular Reference	Square Reference	Round Reference
<b>For non-illuminated push buttons</b>					
0	White		ZB6YD100	ZB6YC100	ZB6YA100
	Black		ZB6YD200	ZB6YC200	ZB6YA200
1	White		ZB6YD101	ZB6YC101	ZB6YA101
	Black		ZB6YD201	ZB6YC201	ZB6YA201
2	White		ZB6YD102	ZB6YC102	ZB6YA102
	Black		ZB6YD202	ZB6YC202	ZB6YA202
3	White		ZB6YD103	ZB6YC103	ZB6YA103
	Black		ZB6YD203	ZB6YC203	ZB6YA203
4	White		ZB6YD104	ZB6YC104	ZB6YA104
	Black		ZB6YD204	ZB6YC204	ZB6YA204
5	White		ZB6YD105	ZB6YC105	ZB6YA105
	Black		ZB6YD205	ZB6YC205	ZB6YA205
6	White		ZB6YD106	ZB6YC106	ZB6YA106
	Black		ZB6YD206	ZB6YC206	ZB6YA206
7	White		ZB6YD107	ZB6YC107	ZB6YA107
	Black		ZB6YD207	ZB6YC207	ZB6YA207
8	White		ZB6YD108	ZB6YC108	ZB6YA108
	Black		ZB6YD208	ZB6YC208	ZB6YA208
9	White		ZB6YD109	ZB6YC109	ZB6YA109
	Black		ZB6YD209	ZB6YC209	ZB6YA209
ON	White		ZB6YD117	ZB6YC117	ZB6YA117
	Green		ZB6YD317	ZB6YC317	ZB6YA317
OFF	Black		ZB6YD224	ZB6YC224	ZB6YA224
	Red		ZB6YD424	ZB6YC424	ZB6YA424
I	White		ZB6YD111	ZB6YC111	ZB6YA111
	Green		ZB6YD311	ZB6YC311	ZB6YA311
O	Black		ZB6YD210	ZB6YC210	ZB6YA210
	Red		ZB6YD410	ZB6YC410	ZB6YA410
R	Black		ZB6YD226	ZB6YC226	ZB6YA226
	Blue		ZB6YD626	ZB6YC626	ZB6YA626
START	White		ZB6YD140	ZB6YC140	ZB6YA140
	Green		ZB6YD340	ZB6YC340	ZB6YA340
STOP	Black		ZB6YD241	ZB6YC241	ZB6YA241
	Red		ZB6YD441	ZB6YC441	ZB6YA441
II	White		ZB6YD112	ZB6YC112	ZB6YA112
	Black		ZB6YD212	ZB6YC212	ZB6YA212
III	White		ZB6YD113	ZB6YC113	ZB6YA113
	Black		ZB6YD213	ZB6YC213	ZB6YA213
+	White		ZB6YD114	ZB6YC114	ZB6YA114
	Black		ZB6YD214	ZB6YC214	ZB6YA214
-	White		ZB6YD115	ZB6YC115	ZB6YA115
	Black		ZB6YD215	ZB6YC215	ZB6YA215
UP	White		ZB6YD127	ZB6YC127	ZB6YA127
	Black		ZB6YD227	ZB6YC227	ZB6YA227
DOWN	White		ZB6YD128	ZB6YC128	ZB6YA128
	Black		ZB6YD228	ZB6YC228	ZB6YA228
CLOSE	White		ZB6YD132	ZB6YC132	ZB6YA132
	Black		ZB6YD232	ZB6YC232	ZB6YA232
↑	White		ZB6YD119	ZB6YC119	ZB6YA119
	Black		ZB6YD219	ZB6YC219	ZB6YA219
↓	White		ZB6YD120	ZB6YC120	ZB6YA120
	Black		ZB6YD220	ZB6YC220	ZB6YA220
→	White		ZB6YD121	ZB6YC121	ZB6YA121
	Black		ZB6YD221	ZB6YC221	ZB6YA221
←	White		ZB6YD122	ZB6YC122	ZB6YA122
	Black		ZB6YD222	ZB6YC222	ZB6YA222

# Harmony™ XB6/ZB6

## 16 mm push buttons

### Accessories

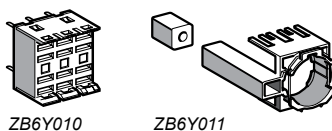
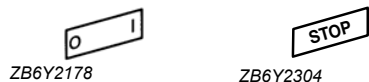
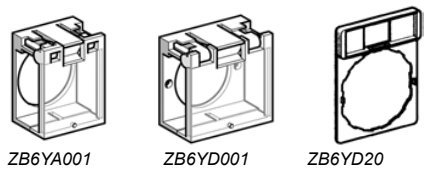
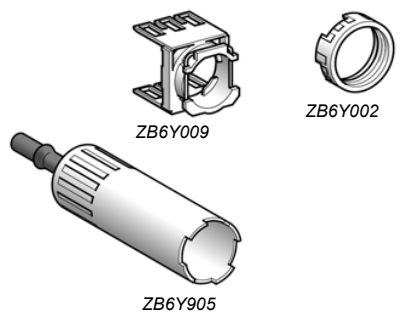

#### Accessories

Description	Application	Reference
<b>Body</b>	Attaching contact blocks	<b>ZB6Y009</b>
<b>Bezel tightening tool + bulb extractor</b>	Mounting the switch and changing bulbs	<b>ZB6Y905</b>
<b>Three piece dismantling tool kit</b>	Removing contacts, mounting nuts and push button caps	<b>ZB6Y019</b>
<b>Nut</b>	Mounting head to panel	<b>ZB6Y002</b>
<b>Adaptor</b>	Flush mounting a circular head push button or pilot light in 22 mm cut-out	<b>ZB6YA002</b>
<b>Shroud</b>	Protecting contacts against touching	<b>ZB6Y001</b>
<b>Protective cover</b>	Circular and square head push buttons and switches	<b>ZB6YA001</b>
	Rectangular head push buttons and switches	<b>ZB6YD001</b>
<b>Female Quick connector/Solder tab</b>	Sold in lots of 100 pieces	<b>ZB6Y004</b>
<b>Blanking plug</b>	Plugging an unused knockout	<b>ZB6Y005</b>
<b>Ronis key, 2 pieces</b>	Key operated selector switches and emergency stop mushroom	<b>ZB6Y007</b>
<b>Incandescent bulbs, bayonet T1 1/4</b>	6 V	<b>ZB6YA006</b>
	12 V	<b>ZB6YJ012</b>
	28 V (1)	<b>ZB6YB028</b>
<b>Neon bulbs</b>	110/230 V (2)	<b>ZB6YG095</b>

(1) 28 V bulb supplied, for use on 24 V.

(2) 95 V bulb supplied, for use on 110/230 V.

#### Standard Legend Plate (24 x 28 mm) for 8 x 21 mm Legend (3)

Description	Background Color of Legend	Reference
<b>Without legend insert</b>	—	<b>ZB6YD20</b>
<b>With blank legend insert</b>	White or yellow	<b>ZB6YD21</b>
	Black or red	<b>ZB6YD22</b>

#### 8 x 21 mm Marked Legends (for 24 x 28 mm legend holder ZB6YD20) (3)

Color	Marking	Reference
<b>White Text</b>	International O-I	<b>ZB6Y2178</b>
<b>Red Background (Stop and Fault)</b>	I-II	<b>ZB6Y2179</b>
<b>Black Background (all others)</b>	I-O-II	<b>ZB6Y2186</b>
	← O →	<b>ZB6Y2190</b>
<b>English</b>	HAND-O-AUTO	<b>ZB6Y2387</b>
	CLOSE	<b>ZB6Y2314</b>
	DOWN	<b>ZB6Y2308</b>
	FORWARD	<b>ZB6Y2305</b>
	FAULT	<b>ZB6Y2334</b>
	LEFT	<b>ZB6Y2310</b>
	OFF	<b>ZB6Y2312</b>
	ON	<b>ZB6Y2303</b>
	OPEN	<b>ZB6Y2313</b>
	RESET	<b>ZB6Y2323</b>
	REVERSE	<b>ZB6Y2306</b>
	RIGHT	<b>ZB6Y2309</b>
	RUN	<b>ZB6Y2311</b>
	STOP	<b>ZB6Y2304</b>
	UP	<b>ZB6Y2307</b>

(3) Additional legend plate sizes and markings are available in Catalog 9001CT0001.

#### Circular Legends, 45 mm

Description	Color	Text	Reference
<b>Circular legends, 45 mm</b>	Yellow	Blank	<b>ZB6Y7001</b>
		Emergency stop	<b>ZB6Y7330</b>

#### Accessories for Printed Circuit Board Mounting

Description	for use with	Reference
<b>Plug-in Socket Adapter</b>	contact blocks and light modules	<b>ZB6Y010</b>
<b>Body Bracket</b>	plug-in socket adapter	<b>ZB6Y011</b>



## Push buttons (illuminated and non illuminated)

### Rectangular head

**XB6DW●●●●, DF●●●●, DA●●**

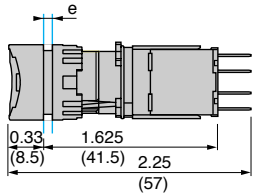

e: panel thickness  
1 to 6 mm

**XB6DE●●●●**

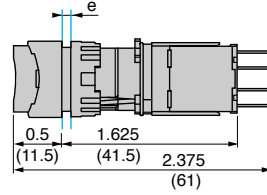

Common face view

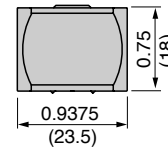

### Square head

**XB6CW●●●●, CF●●●●, CA●●**

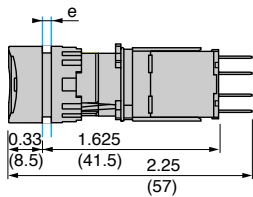

e: panel thickness  
1 to 6 mm

**XB6CE●●●●**

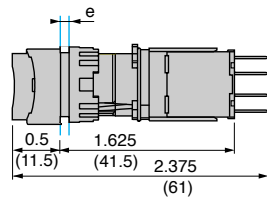

Common face view

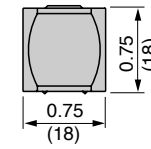

### Circular head

**XB6AW●●●●, AF●●●●, AA●●**

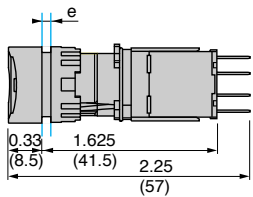

e: panel thickness  
1 to 6 mm

**XB6AE●●●●**

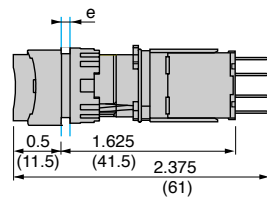

Common face view



## Mushroom head push buttons

**XB6AS8349B**

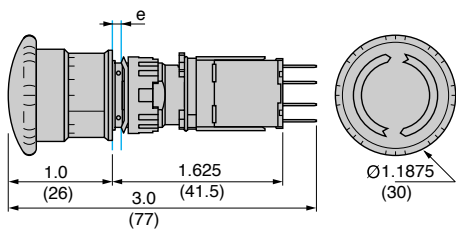

e: panel thickness  
1 to 6 mm

**XB6AS9349B**

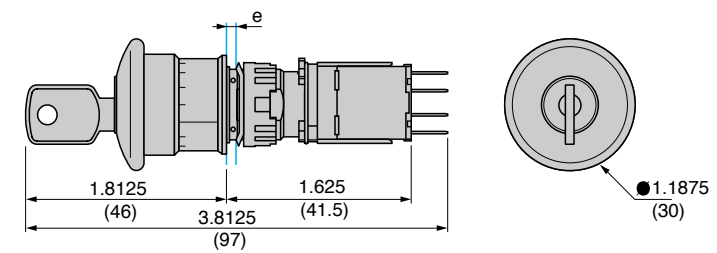

## Pilot lights

### Common side view

**XB6DV●●●, XB6CV●●●**

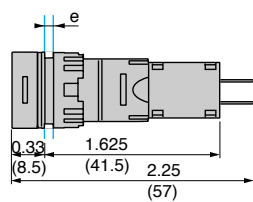

e: panel thickness  
1 to 6 mm

### Rectangular head

**XB6DV●●●**

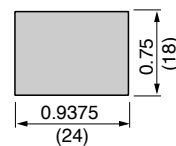

### Square head

**XB6CV●●●**

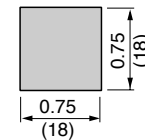

### Circular head

**XB6AV●●●**

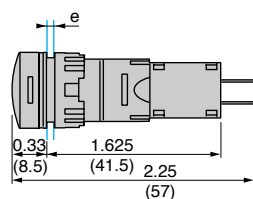

e: panel thickness  
1 to 6 mm

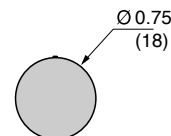

Dual Dimensions: in (mm)

# Harmony™ XB6/ZB6 16 mm push buttons

## Selector switches, standard handle (illuminated and non illuminated)

### Rectangular head

XB6DD●●●●,

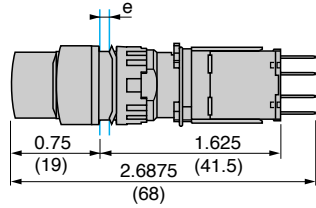

### Square head

XB6CD●●●●,

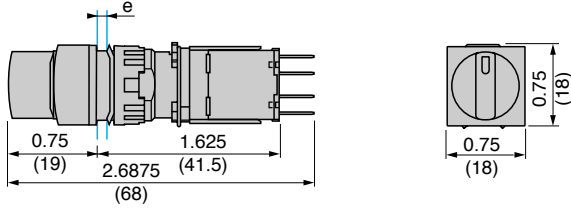

e: panel thickness 1 to 6 mm

### Circular head

XB6AD●●●●

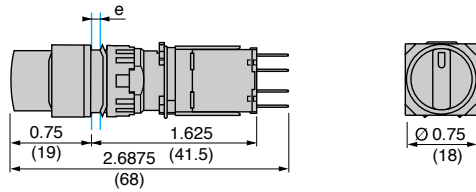

e: panel thickness 1 to 6 mm

## Key switches

### Rectangular head

XB6DG●●●

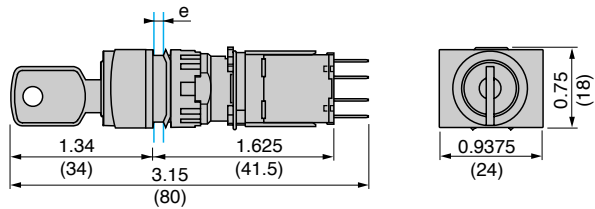

### Square head

XB6CG●●●

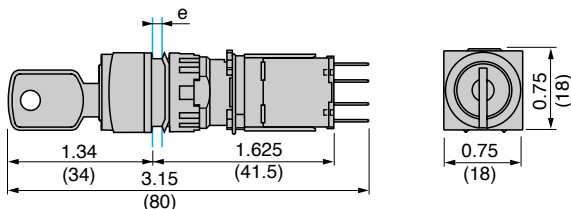

e: panel thickness 1 to 6 mm

### Circular head

XB6AG●●●

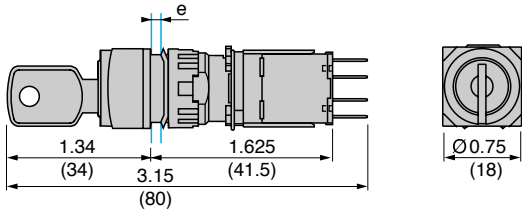

e: panel thickness 1 to 6 mm

Dual Dimensions: in (mm)

# Harmony™ XB6/ZB6 16 mm push buttons

## Push buttons

### Bodies for illuminated push buttons

ZB6Z●●B

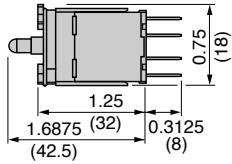

### Heads for illuminated and non illuminated push buttons

#### Rectangular

ZB6DW●, DF●, DA●

ZB6DE●

Common face view

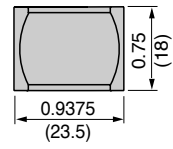
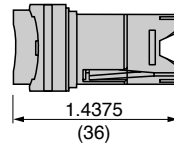
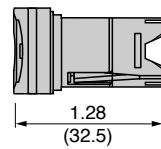

### Bodies for non illuminated push buttons

ZB6Z●B

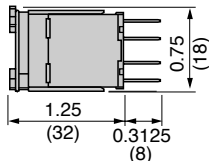

#### Square

ZB6CW●, CF●, CA●

ZB6CE●

Common face view

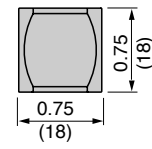
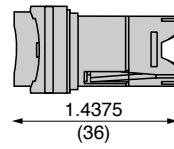
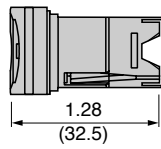

#### Circular

ZB6AW●, AF●, AA●

ZB6AE●

Common face view

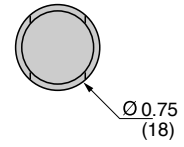
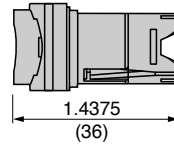
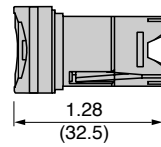

### Heads for mushroom head push buttons

#### Trigger action

ZB6AS834

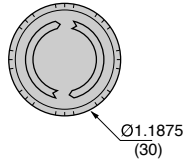
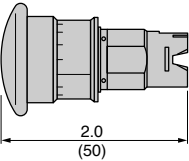

#### Trigger action

ZB6AS934

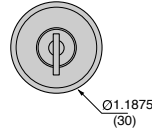
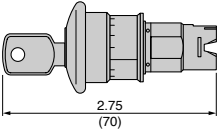

## Pilot lights

### Bodies

ZB6EB●●

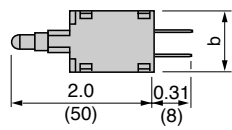

### Rectangular head

ZB6DV●

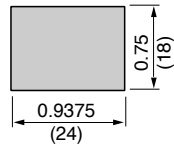
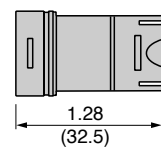

### Square head

ZB6CV●

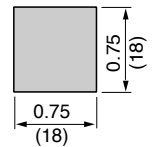
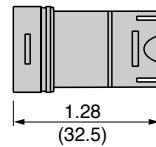

**b**

ZB6E●●B 13.5

ZB6EB●A 15.5

### Circular head

ZB6AV●

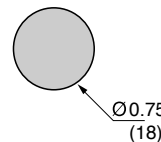
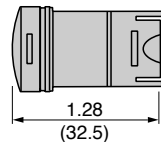

Dual Dimensions: in (mm)

Product range:  
page 5

Specifications:  
page 10

Assembled products:  
page 12

References:  
page 15

## Selector switches, standard handle (illuminated and non illuminated)

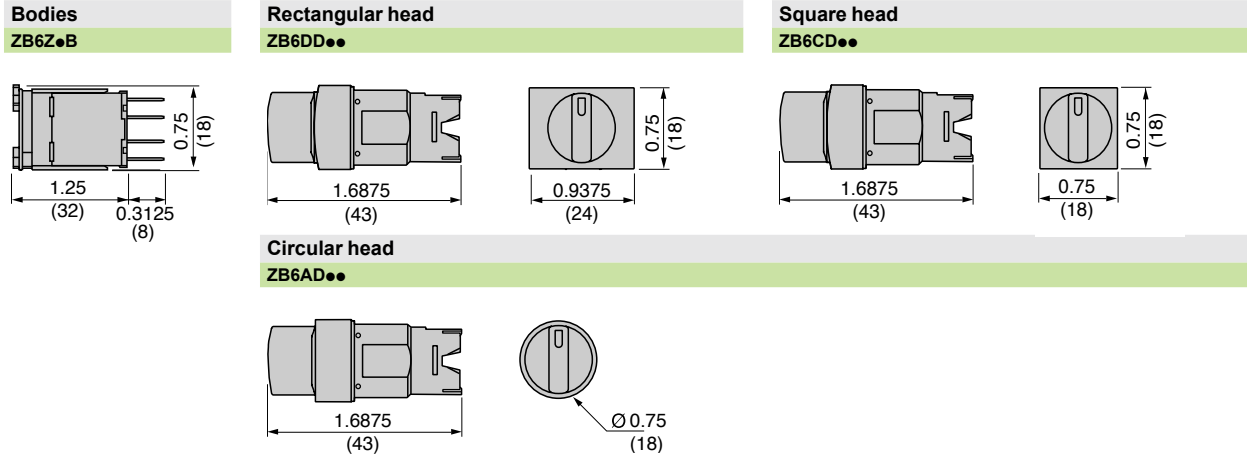

## Key switches

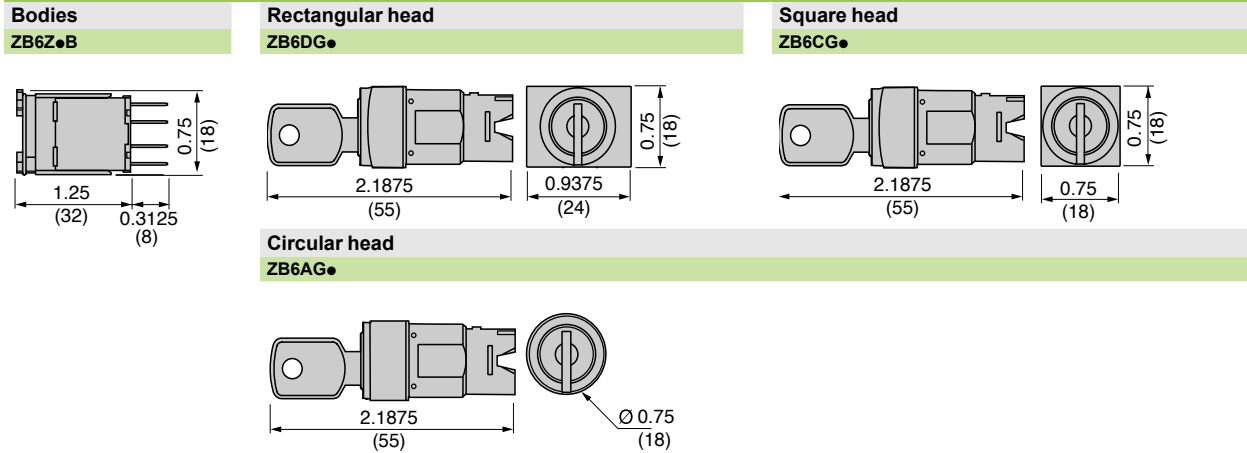

## Protective shutter

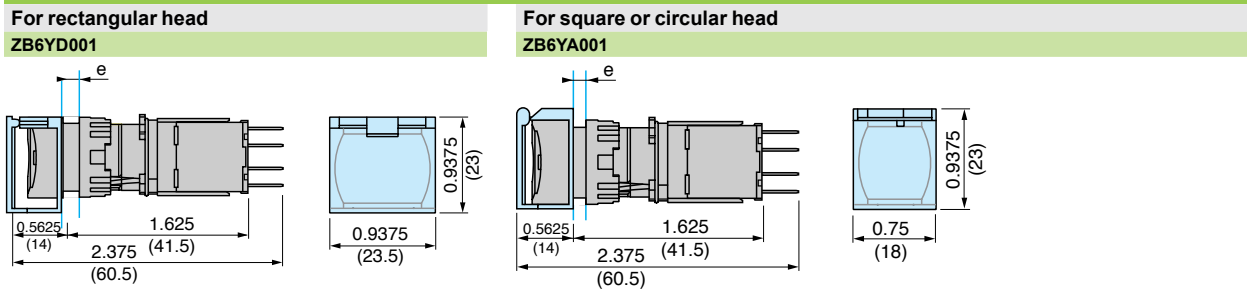

e: panel thickness 1 to 6 mm

## Plug-in socket adaptor for printed circuit board mounting and body bracket

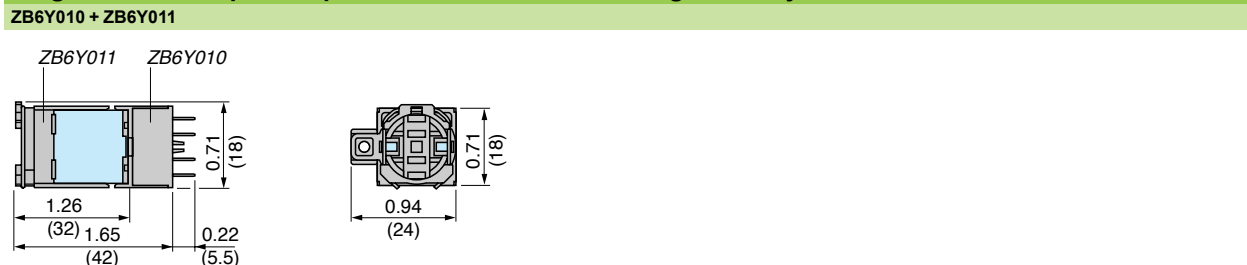

Dual Dimensions: in (mm)

**Panel cut-out and mounting**

**Rectangular head**

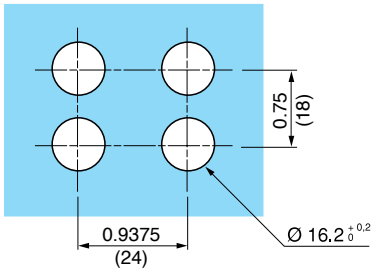

**Square or circular head**

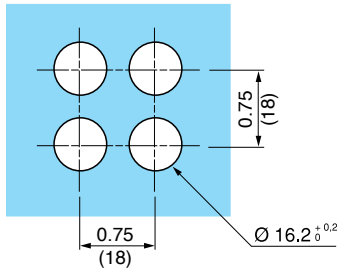

Dual Dimensions: in (mm)

## Push buttons, switches and pilot lights for printed circuit board connection

Front panel cut-out (viewed from installer's side)

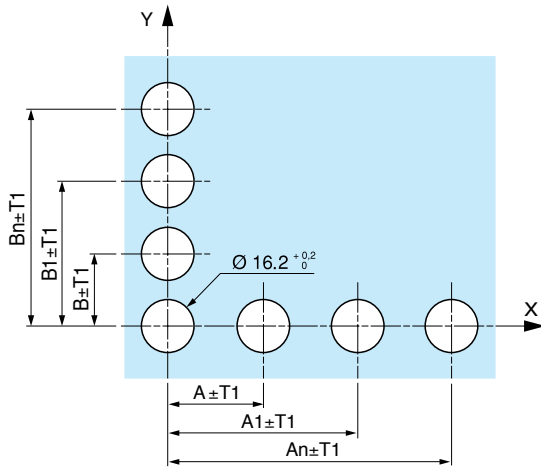

Printed circuit board drillings (viewed from electrical block side) (1)

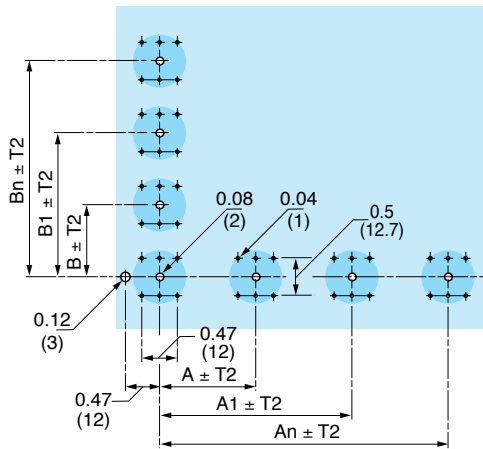

A: 24 mm minimum for rectangular heads  
18 mm minimum for square or circular heads

B:: 18 mm minimum

1 6 x Ø 1.1 mm holes.

2 1 x Ø 2.6  $\varnothing_{0.2}$  hole for locating pin, only when using socket adaptor ZB6Y010.

3 1 x Ø 3.2  $\varnothing_{0.2}$  hole for mounting of printed circuit board onto the front panel using body bracket ZB6Y011.

This hole must be drilled on the left side, when heads are positioned at the normal angle. Attach a body bracket ZB6Y011 every 72 mm maximum for cut-outs on 24 mm centers (rectangular heads) and 54 mm maximum for cut-outs on 18 mm centers (square or circular heads).

### General tolerances of the panel and printed circuit board: T1, T2

The cumulative tolerance must not exceed 0.3 mm: **T1 + T2 = 0.3 mm maximum.**

### Installation precautions:

Thickness of printed circuit board: 1.6 mm minimum.

(1) The cut-out dimensions are the same for direct mounting and for mounting using socket adaptor ZB6Y010.

## Mounting with body bracket

With socket adaptor ZB6Y010

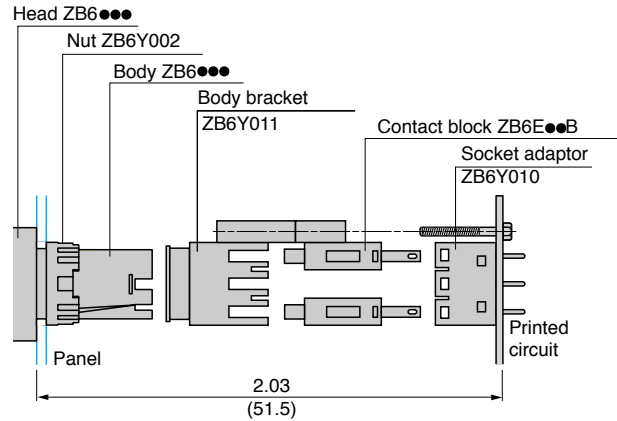

Direct mounting without socket adaptor ZB6Y010

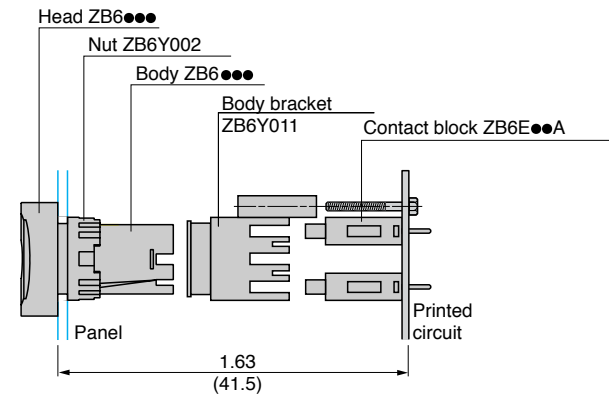

Dual Dimensions: in (mm)

<b>XB6</b>					
XB6AA11B	13, 16	XB6CA31B	13, 16	XB6DE1B1B	15
XB6AA15B	13, 16	XB6CA35B	13, 16	XB6DE1B5B	15
XB6AA21B	16	XB6CA42B	16	XB6DE3B1B	15
XB6AA22B	16	XB6CA45B	13, 16	XB6DE3B5B	15
XB6AA25B	13, 16	XB6CA51B	16	XB6DE4B2B	15
XB6AA31B	13, 16	XB6CA55B	16	XB6DE4B5B	15
XB6AA35B	13, 16	XB6CA61B	16	XB6DE5B1B	15
XB6AA42B	16	XB6CA65B	16	XB6DE5B5B	15
XB6AA45B	13, 16	XB6CD221B	14, 17	XB6DE6B1B	15
XB6AA51B	16	XB6CD225B	14, 17	XB6DE6B5B	15
XB6AA55B	16	XB6CD233B	17	XB6DF1B1B	15
XB6AA61B	16	XB6CD235B	14, 17	XB6DF1B5B	12, 15
XB6AA65B	16	XB6CE1B1B	15	XB6DF3B1B	12, 15
XB6AD221B	14, 17	XB6CE1B5B	15	XB6DF3B5B	12, 15
XB6AD225B	14, 17	XB6CE3B1B	15	XB6DF4B2B	12, 15
XB6AD233B	17	XB6CE3B5B	15	XB6DF4B5B	12, 15
XB6AD235B	14, 17	XB6CE4B2B	15	XB6DF5B1B	15
XB6AE1B1B	15	XB6CE4B5B	15	XB6DF5B5B	15
XB6AE1B5B	15	XB6CE5B1B	15	XB6DF6B1B	15
XB6AE3B1B	15	XB6CE5B5B	15	XB6DF6B5B	15
XB6AE3B5B	15	XB6CE6B1B	15	XB6DGB5B	17
XB6AE4B2B	15	XB6CE6B5B	15	XB6DGC5B	14, 17
XB6AE4B5B	15	XB6CF1B1B	15	XB6DGH3B	17
XB6AE5B1B	15	XB6CF1B5B	12, 15	XB6DGH5B	14, 17
XB6AE5B5B	15	XB6CF3B1B	12, 15	XB6DV1BB	12, 16
XB6AE6B1B	15	XB6CF3B5B	12, 15	XB6DV1GB	16
XB6AE6B5B	15	XB6CF4B2B	12, 15	XB6DV3BB	12, 16
XB6AF1B1B	15	XB6CF4B5B	12, 15	XB6DV3GB	16
XB6AF1B5B	15	XB6CF5B1B	15	XB6DV4BB	12, 16
XB6AF1B5B	12, 15	XB6CF5B5B	15	XB6DV4GB	16
XB6AF3B1B	12, 15	XB6CF6B1B	15	XB6DV5BB	12, 16
XB6AF3B5B	12, 15	XB6CF6B5B	15	XB6DV5GB	16
XB6AF4B2B	12, 15	XB6CGB5B	17	XB6DV6BB	16
XB6AF4B5B	12, 15	XB6CGC5B	14, 17	XB6DV6GB	16
XB6AF5B1B	15	XB6CGH3B	17	XB6DW1B1B	12, 15
XB6AF5B5B	15	XB6CGH5B	14, 17	XB6DW1B5B	12, 15
XB6AF6B1B	15	XB6CV1BB	12, 16	XB6DW3B1B	12, 15
XB6AF6B5B	15	XB6CV1GB	16	XB6DW3B5B	12, 15
XB6AGB5B	17	XB6CV3BB	12, 16	XB6DW4B2B	12, 15
XB6AGC5B	14, 17	XB6CV3GB	16	XB6DW4B5B	12, 15
XB6AGH3B	17	XB6CV4BB	12, 16	XB6DW5B1B	15
XB6AGH5B	14, 17	XB6CV4GB	16	XB6DW5B5B	12, 15
XB6AS8342B	16	XB6CV5BB	12, 16	XB6DW6B1B	15
XB6AS8345B	16	XB6CV5GB	16	XB6DW6B5B	15
XB6AS8349B	13	XB6CV6BB	16	<b>ZB6</b>	
XB6AS9342B	16	XB6CV6GB	16	ZB6AA1	20
XB6AS9345B	16	XB6CW1B1B	12, 15	ZB6AA2	20
XB6AS9349B	13	XB6CW1B5B	12, 15	ZB6AA3	20
XB6AV1BB	12, 16	XB6CW3B1B	12, 15	ZB6AA4	20
XB6AV1GB	16	XB6CW3B5B	12, 15	ZB6AA5	20
XB6AV3BB	12, 16	XB6CW4B2B	12, 15	ZB6AA6	20
XB6AV3GB	16	XB6CW4B5B	12, 15	ZB6AA9	20
XB6AV4BB	12, 16	XB6CW5B1B	15	ZB6AD22	20
XB6AV4GB	16	XB6CW5B5B	12, 15	ZB6AD23	20
XB6AV5BB	12, 16	XB6CW6B1B	15	ZB6AD24	20
XB6AV5GB	16	XB6CW6B5B	15	ZB6AD25	20
XB6AV6BB	16	XB6DA11B	13, 16	ZB6AD26	20
XB6AV6GB	16	XB6DA15B	13, 16	ZB6AD27	20
XB6AW1B1B	12, 15	XB6DA21B	16	ZB6AD28	20
XB6AW1B5B	12, 15	XB6DA22B	16	ZB6AE1	19
XB6AW3B1B	12, 15	XB6DA25B	13, 16	ZB6AE3	19
XB6AW3B5B	12, 15	XB6DA31B	13, 16	ZB6AE4	19
XB6AW4B2B	12, 15	XB6DA35B	13, 16	ZB6AE5	19
XB6AW4B5B	12, 15	XB6DA42B	16	ZB6AE6	19
XB6AW5B1B	15	XB6DA45B	13, 16	ZB6AE9	19
XB6AW5B5B	12, 15	XB6DA51B	16	ZB6AF1	19
XB6AW6B1B	15	XB6DA55B	16	ZB6AF3	19
XB6AW6B5B	15	XB6DA61B	16	ZB6AF4	19
XB6CA11B	13, 16	XB6DA65B	16	ZB6AF5	19
XB6CA15B	13, 16	XB6DD221B	14, 17	ZB6AF6	19
XB6CA21B	16	XB6DD225B	14, 17	ZB6AF9	19
XB6CA22B	16	XB6DD233B	17	ZB6AGA	21
XB6CA25B	13, 16	XB6DD235B	14, 17	ZB6AGB	21
				ZB6AGC	21
				ZB6AGD	21
				ZB6AGE	21
				ZB6AGF	21
				ZB6AGG	21
				ZB6AGH	21
				ZB6AGJ	21
				ZB6AGK	21
				ZB6AGL	21
				ZB6AGQ	21
				ZB6AGR	21
				ZB6AGS	21
				ZB6AGT	21
				ZB6AS834	13, 20
				ZB6AS934	13, 20
				ZB6AV1	19
				ZB6AV3	19
				ZB6AV4	19
				ZB6AV5	19
				ZB6AV6	19
				ZB6AV9	19
				ZB6AW1	19
				ZB6AW3	19
				ZB6AW4	19
				ZB6AW5	19
				ZB6AW6	19
				ZB6AW9	19
				ZB6CA1	20
				ZB6CA2	20
				ZB6CA3	20
				ZB6CA4	20
				ZB6CA5	20
				ZB6CA6	20
				ZB6CA9	20
				ZB6CD22	20
				ZB6CD23	20
				ZB6CD24	20
				ZB6CD25	20
				ZB6CD26	20
				ZB6CD27	20
				ZB6CD28	20
				ZB6CE1	19
				ZB6CE3	19
				ZB6CE4	19
				ZB6CE5	19
				ZB6CE6	19
				ZB6CE9	19
				ZB6CF1	19
				ZB6CF3	19
				ZB6CF4	19
				ZB6CF5	19
				ZB6CF6	19
				ZB6CF9	19
				ZB6CGA	21
				ZB6CGB	21
				ZB6CGC	21
				ZB6CGD	21
				ZB6CGE	21
				ZB6CGF	21
				ZB6CGG	21
				ZB6CGH	21
				ZB6CGJ	21
				ZB6CGL	21
				ZB6CGQ	21
				ZB6CGR	21
				ZB6CGS	21
				ZB6CGT	21
				ZB6CV1	19
				ZB6CV3	19
				ZB6CV4	19
				ZB6CV5	19
				ZB6CV6	19
				ZB6CV9	19
				ZB6CW1	19
				ZB6CW3	19
				ZB6CW4	19
				ZB6CW5	19
				ZB6CW6	19
				ZB6CW9	19
				ZB6DA1	13, 20
				ZB6DA2	13, 20
				ZB6DA3	13, 20
				ZB6DA4	13, 20
				ZB6DA5	20
				ZB6DA6	20
				ZB6DA9	20
				ZB6DD22	14, 20
				ZB6DD23	14, 20
				ZB6DD24	14, 20
				ZB6DD25	14, 20
				ZB6DD26	20
				ZB6DD27	20
				ZB6DD28	20
				ZB6DE1	19
				ZB6DE3	19
				ZB6DE4	19
				ZB6DE5	19
				ZB6DE6	19
				ZB6DE9	19
				ZB6DF1	12, 19
				ZB6DF3	12, 19
				ZB6DF4	12, 19
				ZB6DF5	12, 19
				ZB6DF6	19
				ZB6DF9	19
				ZB6DGA	21
				ZB6DGB	14, 21
				ZB6DGC	14, 21
				ZB6DGD	21
				ZB6DGE	21
				ZB6DGF	21
				ZB6DGG	21
				ZB6DGH	14, 21
				ZB6DGJ	21
				ZB6DGK	21
				ZB6DGL	21
				ZB6DGG	21
				ZB6DGR	21
				ZB6DGS	14, 21
				ZB6DGT	21
				ZB6DV1	12, 19
				ZB6DV3	12, 19
				ZB6DV4	12, 19
				ZB6DV5	12, 19
				ZB6DV6	12, 19
				ZB6DV9	19
				ZB6DW1	12, 19
				ZB6DW3	12, 19
				ZB6DW4	12, 19
				ZB6DW5	12, 19
				ZB6DW6	19
				ZB6DW9	19
				ZB6E1B	18
				ZB6E1E	18
				ZB6E2B	13, 18
				ZB6E2E	18
				ZB6EB1B	18
				ZB6EB3B	18
				ZB6EB4B	18
				ZB6EB5B	18
				ZB6EB6B	18
				ZB6EG0B	18
				ZB6EG1B	18
				ZB6EG3B	18
				ZB6EG4B	18

ZB6EG5B	18	ZB6YA206	23	ZB6YC228	23	ZB6Z2B	12, 13, 14, 18
ZB6EG6B	18	ZB6YA207	23	ZB6YC232	23	ZB6Z3B	18
ZB6EH0B	18	ZB6YA208	23	ZB6YC241	23	ZB6Z4B	18
ZB6EM0B	18	ZB6YA209	23	ZB6YC311	23	ZB6Z5B	12, 13, 18
ZB6E•1B	12	ZB6YA210	23	ZB6YC317	23	ZB6ZB11B	18
ZB6E•3B	12	ZB6YA212	23	ZB6YC340	23	ZB6ZB15B	18
ZB6E•4B	12	ZB6YA213	23	ZB6YC410	23	ZB6ZB31B	18
ZB6E•5B	12	ZB6YA214	23	ZB6YC424	23	ZB6ZB35B	18
ZB6E•6B	12	ZB6YA215	23	ZB6YC441	23	ZB6ZB42B	18
ZB6Y001	24	ZB6YA219	23	ZB6YC626	23	ZB6ZB45B	18
ZB6Y002	24	ZB6YA220	23	ZB6YD001	24	ZB6ZB51B	18
ZB6Y004	24	ZB6YA221	23	ZB6YD100	23	ZB6ZB52B	18
ZB6Y005	24	ZB6YA222	23	ZB6YD101	23	ZB6ZB55B	18
ZB6Y007	24	ZB6YA224	23	ZB6YD102	23	ZB6ZB61B	18
ZB6Y009	24	ZB6YA226	23	ZB6YD103	23	ZB6ZB65B	18
ZB6Y010	24	ZB6YA227	23	ZB6YD104	23	ZB6ZG11B	18
ZB6Y011	24	ZB6YA228	23	ZB6YD105	23	ZB6ZG15B	18
ZB6Y019	24	ZB6YA232	23	ZB6YD106	23	ZB6ZG31B	18
ZB6Y2178	22, 24	ZB6YA241	23	ZB6YD107	23	ZB6ZG35B	18
ZB6Y2179	22, 24	ZB6YA311	23	ZB6YD108	23	ZB6ZG42B	18
ZB6Y2186	22, 24	ZB6YA317	23	ZB6YD109	23	ZB6ZG45B	18
ZB6Y2190	22, 24	ZB6YA340	23	ZB6YD111	23	ZB6ZG51B	18
ZB6Y2303	22, 24	ZB6YA410	23	ZB6YD112	23	ZB6ZG52B	18
ZB6Y2304	22, 24	ZB6YA424	23	ZB6YD113	23	ZB6ZG55B	18
ZB6Y2305	22, 24	ZB6YA441	23	ZB6YD114	23	ZB6ZG61B	18
ZB6Y2306	22, 24	ZB6YA626	23	ZB6YD115	23	ZB6ZG65B	18
ZB6Y2307	22, 24	ZB6YB028	24	ZB6YD117	23	ZB6ZH01B	18
ZB6Y2308	22, 24	ZB6YC100	23	ZB6YD119	23	ZB6ZH02B	18
ZB6Y2309	22, 24	ZB6YC101	23	ZB6YD120	23	ZB6ZH05B	18
ZB6Y2310	22, 24	ZB6YC102	23	ZB6YD121	23		
ZB6Y2311	22, 24	ZB6YC103	23	ZB6YD122	23		
ZB6Y2312	22, 24	ZB6YC104	23	ZB6YD127	23		
ZB6Y2313	22, 24	ZB6YC105	23	ZB6YD128	23		
ZB6Y2314	22, 24	ZB6YC106	23	ZB6YD132	23		
ZB6Y2323	22, 24	ZB6YC107	23	ZB6YD140	23		
ZB6Y2334	22, 24	ZB6YC108	23	ZB6YD20	22, 24		
ZB6Y2387	22, 24	ZB6YC109	23	ZB6YD200	23		
ZB6Y7001	16, 20, 24	ZB6YC111	23	ZB6YD201	23		
ZB6Y7330	16, 20, 24	ZB6YC112	23	ZB6YD202	23		
ZB6Y905	24	ZB6YC113	23	ZB6YD203	23		
ZB6YA001	24	ZB6YC114	23	ZB6YD204	23		
ZB6YA002	24	ZB6YC115	23	ZB6YD205	23		
ZB6YA006	24	ZB6YC117	23	ZB6YD206	23		
ZB6YA100	23	ZB6YC119	23	ZB6YD207	23		
ZB6YA101	23	ZB6YC120	23	ZB6YD208	23		
ZB6YA102	23	ZB6YC121	23	ZB6YD209	23		
ZB6YA103	23	ZB6YC122	23	ZB6YD21	22, 24		
ZB6YA104	23	ZB6YC127	23	ZB6YD210	23		
ZB6YA105	23	ZB6YC128	23	ZB6YD212	23		
ZB6YA106	23	ZB6YC132	23	ZB6YD213	23		
ZB6YA107	23	ZB6YC140	23	ZB6YD214	23		
ZB6YA108	23	ZB6YC200	23	ZB6YD215	23		
ZB6YA109	23	ZB6YC201	23	ZB6YD219	23		
ZB6YA111	23	ZB6YC202	23	ZB6YD22	22, 24		
ZB6YA112	23	ZB6YC203	23	ZB6YD220	23		
ZB6YA113	23	ZB6YC204	23	ZB6YD221	23		
ZB6YA114	23	ZB6YC205	23	ZB6YD222	23		
ZB6YA115	23	ZB6YC206	23	ZB6YD224	23		
ZB6YA117	23	ZB6YC207	23	ZB6YD226	23		
ZB6YA119	23	ZB6YC208	23	ZB6YD227	23		
ZB6YA120	23	ZB6YC209	23	ZB6YD228	23		
ZB6YA121	23	ZB6YC210	23	ZB6YD232	23		
ZB6YA122	23	ZB6YC212	23	ZB6YD241	23		
ZB6YA127	23	ZB6YC213	23	ZB6YD311	23		
ZB6YA128	23	ZB6YC214	23	ZB6YD317	23		
ZB6YA132	23	ZB6YC215	23	ZB6YD340	23		
ZB6YA140	23	ZB6YC219	23	ZB6YD410	23		
ZB6YA200	23	ZB6YC220	23	ZB6YD424	23		
ZB6YA201	23	ZB6YC221	23	ZB6YD441	23		
ZB6YA202	23	ZB6YC222	23	ZB6YD626	23		
ZB6YA203	23	ZB6YC224	23	ZB6YG095	24		
ZB6YA204	23	ZB6YC226	23	ZB6YJ012	24		
ZB6YA205	23	ZB6YC227	23	ZB6Z1B	12, 13, 14, 18		





<http://www.schneider-electric.us/>

**Schneider Electric USA, Inc.**

8001 Knightdale Blvd.  
Knightdale, NC 27545

USA Customer Care Center  
Tel: 888-778-2733

**Schneider Electric Canada**

5985 McLaughlin Rd.  
Mississauga, Ontario, Canada L5R 1B8

Canada Customer Care Center  
Tel: 800-565-6699

The information and dimensions in this catalog are provided for the convenience of our customers. While this information is believed to be accurate, Schneider Electric reserves the right to make updates and changes without prior notification and assumes no liability for any errors or omissions.

Harmony, Schneider Electric and logo are trademarks or registered trademarks of Schneider Electric or its affiliates in the United States and other countries. Other trademarks used herein are the property of their respective owners.

Design: Schneider Electric  
Photos: Schneider Electric