

Main

Range of product	Zelio Control
Product or component type	Industrial measurement and control relays
Relay type	Control relay
Product specific application	For 3-phase supply
Relay name	RM4-T
Relay monitored parameters	Overvoltage and undervoltage detection Phase failure detection Phase sequence
Time delay	Adjustable 0.1...10 s
Measurement range	160...300 V
Contacts type and composition	2 C/O
Poles description	3P

Complementary

[Us] rated supply voltage	220...240 V 50/60 Hz
Control threshold undervoltage	160...220 V
Control threshold overvoltage	220...300 V
Width	22.5 mm
Output contacts	2 C/O
Setting accuracy of the switching threshold	+/-3 %
Switching threshold drift	<= 0.06 % per degree centigrade depending permissible ambient air temperature <= 0.5 % within the measuring range
Setting accuracy of time delay	10 P
Time delay drift	<= 0.07 % per degree centigrade depending on the rated operational temperature <= 0.5 % within the measuring range
Hysteresis	5 % fixed of de-energisation threshold
Run up delay at power up	< 650 s
Measuring cycle	<= 80 ms
Marking	CE : EMC 89/336/EEC CE : LVD 73/23/EEC
Overvoltage category	III conforming to IEC 60664-1
[Ui] rated insulation voltage	500 V conforming to IEC
Supply frequency	50/60 Hz +/- 5 %
Operating position	Any position without
Electrical connection	2 conductors cable 1.5 mm ² flexible with cable end conforming to IEC 60947-1 2 conductors cable 2.5 mm ² flexible without cable end conforming to IEC 60947-1
Tightening torque	0.6...1.1 N.m
Mechanical durability	30000000 cycles
[Ith] conventional free air thermal current	8 A

The information provided in this documentation contains general descriptions and/or technical characteristics of the performance of the products contained herein. This documentation is not intended as a substitute for and is not to be used for determining suitability or reliability of these products for specific user applications. It is the duty of any such user or integrator to perform the appropriate and complete risk analysis, evaluation and testing of the products with respect to the relevant specific application or use thereof. Neither Schneider Electric Industries SAS nor any of its affiliates or subsidiaries shall be responsible or liable for misuse of the information contained herein.

[le] rated operational current	2 A at 70 °C 24 V DC-13 conforming to IEC 60947-5-1/1991 2 A at 70 °C 24 V DC-13 conforming to VDE 0660 3 A at 70 °C 115 V AC-15 conforming to IEC 60947-5-1/1991 3 A at 70 °C 115 V AC-15 conforming to VDE 0660 3 A at 70 °C 24 V AC-15 conforming to IEC 60947-5-1/1991 3 A at 70 °C 24 V AC-15 conforming to VDE 0660 3 A at 70 °C 250 V AC-15 conforming to IEC 60947-5-1/1991 3 A at 70 °C 250 V AC-15 conforming to VDE 0660 0.1 A at 70 °C 250 V DC-13 conforming to IEC 60947-5-1/1991 0.1 A at 70 °C 250 V DC-13 conforming to VDE 0660 0.3 A at 70 °C 115 V DC-13 conforming to IEC 60947-5-1/1991 0.3 A at 70 °C 115 V DC-13 conforming to VDE 0660
Switching capacity in mA	10 mA at 12 V
Switching voltage	<= 440 V AC 250 V AC
Contacts material	90/10 silver nickel contacts
Number of cables	2
CAD overall width	23 mm
CAD overall height	78 mm
CAD overall depth	80 mm
Terminals description ISO n°1	(15-16-18)OC (25-26-28)OC (L1-L2-L3)CO
Output relay state	Tripped, fault present
9 mm pitches	2.5
Product weight	0.11 kg

Environment

Standards	EN/IEC 60255-6
Product certifications	CSA GL UL
Ambient air temperature for storage	-40...85 °C
Ambient air temperature for operation	-20...65 °C
Relative humidity	15...85 % 3K3 conforming to IEC 60721-3-3
Vibration resistance	0.35 ms (f = 10...55 Hz conforming to IEC 60068-2-6
Shock resistance	15 gn for 11 ms conforming to IEC 60068-2-27
IP degree of protection	IP20 (terminals) conforming to IEC 60529 IP50 (casing) conforming to IEC 60529
Pollution degree	3 conforming to IEC 60664-1
Dielectric test voltage	2.5 kV
Non-dissipating shock wave	4.8 kV
Resistance to electrostatic discharge	6 kV contact conforming to IEC 61000-4-2 level 3 8 kV air conforming to IEC 61000-4-2 level 3
Resistance to electromagnetic fields	10 V/m conforming to IEC 61000-4-3 level 3
Resistance to fast transients	2 kV conforming to IEC 61000-4-4 level 3
Protection against electric shocks	2 kV conforming to IEC 61000-4-5 level 3
Disturbance radiated/conducted	CISPR11 group 1- class A CISPR22 - class A

3-phase Supply Control Relays

Dimensions

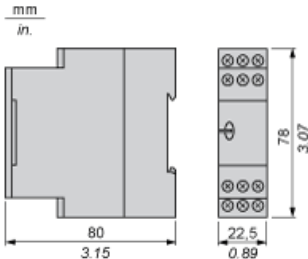

3-phase Supply Control Relays

Rail mounting

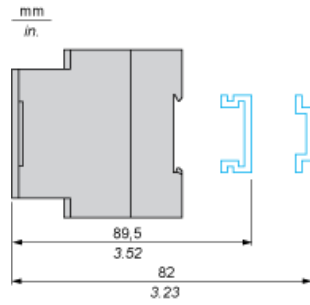

Screw fixing

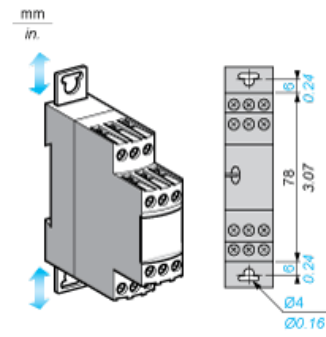

3-Phase Supply Control Relays

Wiring Diagram



- L1, Supply to be monitored
- L2,
- L3
- 15-18 1st C/O contact of the output relay
- 15-16
- 25-28 2nd C/O contact of the output relay
- 25-26

Application Scheme

Example

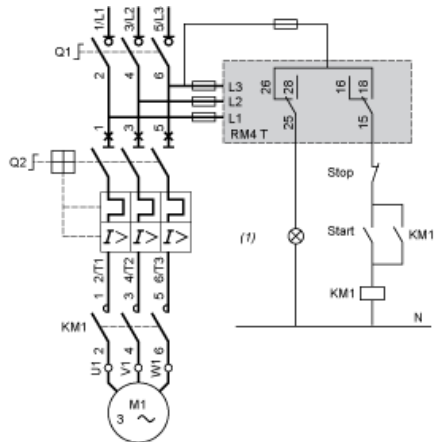

(1) Fault

Electrical Durability and Load Limit Curves

AC Load

Curve 1: Electrical durability of contacts on resistive load in millions of operating cycles

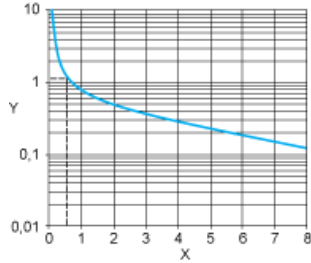

X Current broken in A
Y Millions of operating cycles

Curve 2: Reduction factor k for inductive loads (applies to values taken from durability Curve 1)

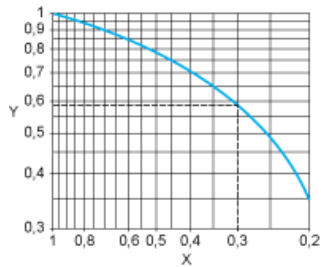

X Power factor on breaking (cos φ)
Y Reduction factor K

Example: An LC1-F185 contactor supplied with 115 V/50 Hz for a consumption of 55 VA or a current consumption equal to 0.5 A and cos φ = 0.3.

For 0.5 A, curve 1 indicates a durability of approximately 1.5 million operating cycles.

As the load is inductive, it is necessary to apply a reduction coefficient k to this number of cycles as indicated by curve 2.

For cos φ = 0.3: k = 0.6

The electrical durability therefore becomes:

$$1.5 \times 10^6 \text{ operating cycles} \times 0.6 = 900\,000 \text{ operating cycles}$$

DC Load

Load limit curve

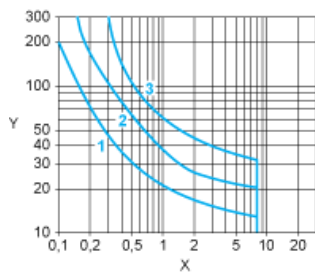

X Current in A
Y Voltage in V
1 L/R = 20 ms
2 L/R with load protection diode
3 Resistive load

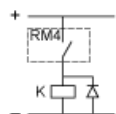

Function Diagram

Overvoltage and Undervoltage Detection

Functions "Fault detection delayed" or "Fault detection extended" (by switch selector)

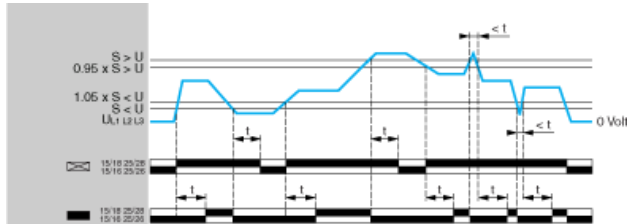

- t Time delay (adjustable from 0.1 s to 10 s with a selector switch)
- U 3-phase supply voltage monitored (between terminals L1, L2 and L3)
- S Overvoltage or undervoltage setting
- 15/18 Output relays connections (refer to Connections and Schema)
- 15/16;
- 25/28,
- 25/26

Relay status: black color = energized.

NOTE: In order to be detected, the duration of the overvoltage or undervoltage must be greater than the measuring cycle time (80 ms).