

Panasonic

ideas for life

Relay for control panel of
1A to 10A (1c/2c/3c/4c)

HC RELAYS

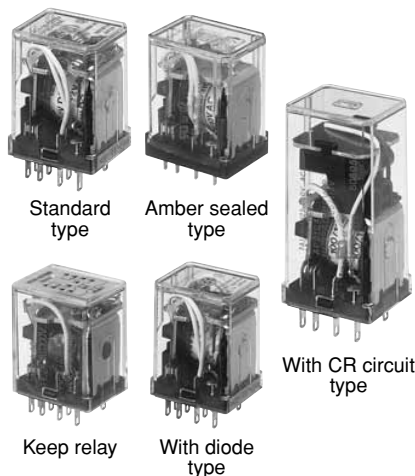

FEATURES

1. Standard type, Amber sealed type and Keep type
2. Rich lineup includes relays with operating indication, with diode and with CR circuit
3. Full range of types Plug-in type, PC board type and TM type
4. Sockets and terminal sockets are available.

TYPICAL APPLICATIONS

1. Factory automation equipment and automotive devices
2. Control panels, power supply equipment, molding equipment, machine tools, welding equipment, agricultural equipment, etc.
3. Office equipment, automatic vending machines, telecommunications equipment, disaster prevention equipment, copiers, measuring devices, medical equipment, amusement devices, etc.
4. All types of household appliance

Compliance with RoHS Directive

ORDERING INFORMATION

HC - - - - -

Contact arrangement

- 1: 1 Form C
- 2: 2 Form C
- 3: 3 Form C
- 4: 4 Form C
- 4D: Bifurcated contact (twin)

Nil: Standard type

E: Amber sealed type (Only 1 Form C and 2 Form C)

ED: Amber sealed type bifurcated contact (twin) (Only 4 Form C)

K: Keep type

Terminal arrangement

- H: Plug-in type
- HL: Plug-in with LED indication
- L: Plug-in with LED indication (Amber sealed type)
- HP: PC board type
- PL: PC board with LED indication
- HPL: PC board with LED indication (Amber sealed type)
- HTM: TM type

Nominal coil voltage

AC 6, 12, 24, 48, 100 (100/110), 120 (110/120), 200 (200/220), 240 (220/240) V
DC 6, 12, 24, 48, 100 (100/110) V

Surge suppression

D: With diode R: With CR circuit

Contact material



| Contact arrangement | Contact material | AgSnO ₂ type | AgNi type |
|--------------------------|------------------|-------------------------|-----------|
| 1 Form C | | F | |
| 2 Form C | | F | |
| 3 Form C | | F | |
| 4 Form C | | | Nil |
| 4-pole bifurcated (twin) | | | Nil |

Notes: Certified by UL and CSA (except for keep type)

Please consult us about VDE (1 Form C, 2 Form C, and 4 Form C only) and TV-3 (1 Form C and 2 Form C only) approved products.

HC

LINEUP

| Type | Contact arrangement | | Plug-in terminal type | | PC board terminal type | | Top mounting type (TM type) | Remarks |
|---|---------------------|----------|---|----------|---|----------|--------------------------------|-------------------------------------|
| | | | Without LED | With LED | Without LED | With LED | | |
| | | |  | |  | | | |
| HC relay Standard type | Single side stable | 1 Form C | A | A | A | A | A | |
| | | 2 Form C | A | A | A | A | A | |
| | | 3 Form C | A | A | A | A | A | |
| | | 4 Form C | A | A | A | A | A | |
| | Bifurcated (Twin) | 4 Form C | A | A | A | A | A | |
| HC relay Amber sealed type | Single side stable | 1 Form C | A | A | A | A | A | |
| | | 2 Form C | A | A | A | A | A | |
| | | 4 Form C | A | A | A | A | A | |
| | Bifurcated (Twin) | 4 Form C | A | A | A | A | A | |
| HC keep (latching) relay | Single side stable | 2 Form C | A (With operating indication) | — | A (With operating indication) | — | — | |
| DC type with surge absorbing diode | Single side stable | 1 Form C | A | A | — | — | — | Amber sealed type also available |
| | | 2 Form C | A | A | — | — | — | |
| | | 3 Form C | A | A | — | — | — | |
| | | 4 Form C | A | A | — | — | — | |
| | Bifurcated (Twin) | 4 Form C | A | A | — | — | — | |
| AC type with surge absorbing CR circuit | Single side stable | 1 Form C | A | A | — | — | — | 17 mm higher than standard type |
| | | 2 Form C | A | A | — | — | — | |
| | | 3 Form C | A | A | — | — | — | |
| | | 4 Form C | A | A | — | — | — | |
| | Bifurcated (Twin) | 4 Form C | A | A | — | — | — | |

A: Available



Notes: 1. HC relays with ground terminals also available.

2. HC relays with 0.9 mm wide PC board terminals also available.

HC RELAY CONTACT ARRANGEMENT

| Type | Single side stable contact | 4-pole bifurcated (twin) contact |
|-------------|--|--|
| Part number | HC□ | HC4D |
| Features | Suitable for high-capacity load switching Standard type HC relays have high single-contact capacity; 1 Form C: 10 A 2 Form C and 3 Form C: 7 A 4 Form C: 5 A | Bifurcated (twin) contact ensures high contact reliability Suitable for low level loads Minimum switching capability: 100 μA 100m V DC (reference value) |

LED INDICATION TYPE

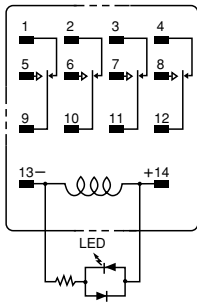
| Type | With LED indication type | | |
|-------------|--|--|---|
| Part number | HC□-HL | | |
| Features | LED lights up when relay is operating Inspection and detection of trouble is easy. LEDs are green for DC types and red for AC types. All types are available with LED indication. |  |  |
| | | <p>• LED colors indicate the type of relay: red for AC type and green for DC type.</p> |  <p>Protection diode (Bottom view)</p> |

HC RELAY SERIES PRODUCT TYPES

| Type | Amber sealed type HC relay | HC keep (Latching) relay | HC relay with diode type (for DC) |
|-------------|---|--|--|
| Part number | HC□E | HC2K | HC□-□-□V-D |
| Features | Relay is completely sealed with resin. Provides high reliability in adverse surroundings. Suitable for use in dusty conditions or where organic gases are present | Magnetic latching relay Suitable for nominal operating power saving of operating circuits and for memory circuits Has operating indication (mechanical indicator). | Has built-in diode to absorb surge when the coil goes to the off state (for DC type). Suitable for protecting relay driver circuits and for noise suppression Diode characteristics: Reverse breakdown voltage 1,000 V Forward current 1 A |
| Type | HC relay with CR circuit (for AC) | — | — |
| Part number | HC□-□-□V-R | — | — |
| Features | Has built-in CR circuit to absorb surge when the coil goes to the off state (for AC). Relay with CR circuit is 17 mm higher than standard type relay. | — | — |

4-pole bifurcated (twin) type and Relay with LED indication are available.

TYPES

1. Standard type

1) Plug-in type

| Nominal coil voltage | 1 Form C | 2 Form C | 3 Form C | 4 Form C | 4 Form C (twin) |
|----------------------|----------------|----------------|----------------|--------------|-----------------|
| | Part No. | Part No. | Part No. | Part No. | Part No. |
| 6V AC | HC1-H-AC6V-F | HC2-H-AC6V-F | HC3-H-AC6V-F | HC4-H-AC6V | HC4D-H-AC6V |
| 12V AC | HC1-H-AC12V-F | HC2-H-AC12V-F | HC3-H-AC12V-F | HC4-H-AC12V | HC4D-H-AC12V |
| 24V AC | HC1-H-AC24V-F | HC2-H-AC24V-F | HC3-H-AC24V-F | HC4-H-AC24V | HC4D-H-AC24V |
| 48V AC | HC1-H-AC48V-F | HC2-H-AC48V-F | HC3-H-AC48V-F | HC4-H-AC48V | HC4D-H-AC48V |
| 100/110V AC | HC1-H-AC100V-F | HC2-H-AC100V-F | HC3-H-AC100V-F | HC4-H-AC100V | HC4D-H-AC100V |
| 110/120V AC | HC1-H-AC120V-F | HC2-H-AC120V-F | HC3-H-AC120V-F | HC4-H-AC120V | HC4D-H-AC120V |
| 200/220V AC | HC1-H-AC200V-F | HC2-H-AC200V-F | HC3-H-AC200V-F | HC4-H-AC200V | HC4D-H-AC200V |
| 220/240V AC | HC1-H-AC240V-F | HC2-H-AC240V-F | HC3-H-AC240V-F | HC4-H-AC240V | HC4D-H-AC240V |
| 6V DC | HC1-H-DC6V-F | HC2-H-DC6V-F | HC3-H-DC6V-F | HC4-H-DC6V | HC4D-H-DC6V |
| 12V DC | HC1-H-DC12V-F | HC2-H-DC12V-F | HC3-H-DC12V-F | HC4-H-DC12V | HC4D-H-DC12V |
| 24V DC | HC1-H-DC24V-F | HC2-H-DC24V-F | HC3-H-DC24V-F | HC4-H-DC24V | HC4D-H-DC24V |
| 48V DC | HC1-H-DC48V-F | HC2-H-DC48V-F | HC3-H-DC48V-F | HC4-H-DC48V | HC4D-H-DC48V |
| 100/110V DC | HC1-H-DC100V-F | HC2-H-DC100V-F | HC3-H-DC100V-F | HC4-H-DC100V | HC4D-H-DC100V |

Standard packing: Carton: 20 pcs.; Case: 200 pcs.

2) Plug-in type (with LED indication)

| Nominal coil voltage | 1 Form C | 2 Form C | 3 Form C | 4 Form C | 4 Form C (twin) |
|----------------------|-----------------|-----------------|-----------------|---------------|-----------------|
| | Part No. | Part No. | Part No. | Part No. | Part No. |
| 6V AC | HC1-HL-AC6V-F | HC2-HL-AC6V-F | HC3-HL-AC6V-F | HC4-HL-AC6V | HC4D-HL-AC6V |
| 12V AC | HC1-HL-AC12V-F | HC2-HL-AC12V-F | HC3-HL-AC12V-F | HC4-HL-AC12V | HC4D-HL-AC12V |
| 24V AC | HC1-HL-AC24V-F | HC2-HL-AC24V-F | HC3-HL-AC24V-F | HC4-HL-AC24V | HC4D-HL-AC24V |
| 100/110V AC | HC1-HL-AC100V-F | HC2-HL-AC100V-F | HC3-HL-AC100V-F | HC4-HL-AC100V | HC4D-HL-AC100V |
| 110/120V AC | HC1-HL-AC120V-F | HC2-HL-AC120V-F | HC3-HL-AC120V-F | HC4-HL-AC120V | HC4D-HL-AC120V |
| 200/220V AC | HC1-HL-AC200V-F | HC2-HL-AC200V-F | HC3-HL-AC200V-F | HC4-HL-AC200V | HC4D-HL-AC200V |
| 220/240V AC | HC1-HL-AC240V-F | HC2-HL-AC240V-F | HC3-HL-AC240V-F | HC4-HL-AC240V | HC4D-HL-AC240V |
| 6V DC | HC1-HL-DC6V-F | HC2-HL-DC6V-F | HC3-HL-DC6V-F | HC4-HL-DC6V | HC4D-HL-DC6V |
| 12V DC | HC1-HL-DC12V-F | HC2-HL-DC12V-F | HC3-HL-DC12V-F | HC4-HL-DC12V | HC4D-HL-DC12V |
| 24V DC | HC1-HL-DC24V-F | HC2-HL-DC24V-F | HC3-HL-DC24V-F | HC4-HL-DC24V | HC4D-HL-DC24V |
| 48V DC | HC1-HL-DC48V-F | HC2-HL-DC48V-F | HC3-HL-DC48V-F | HC4-HL-DC48V | HC4D-HL-DC48V |
| 100/110V DC | HC1-HL-DC100V-F | HC2-HL-DC100V-F | HC3-HL-DC100V-F | HC4-HL-DC100V | HC4D-HL-DC100V |

Standard packing: Carton: 20 pcs.; Case: 200 pcs.

HC

3) PC board type

| Nominal coil voltage | 1 Form C | 2 Form C | 3 Form C | 4 Form C | 4 Form C (twin) |
|----------------------|-----------------|-----------------|-----------------|---------------|-----------------|
| | Part No. | Part No. | Part No. | Part No. | Part No. |
| 6V AC | HC1-HP-AC6V-F | HC2-HP-AC6V-F | HC3-HP-AC6V-F | HC4-HP-AC6V | HC4D-HP-AC6V |
| 12V AC | HC1-HP-AC12V-F | HC2-HP-AC12V-F | HC3-HP-AC12V-F | HC4-HP-AC12V | HC4D-HP-AC12V |
| 24V AC | HC1-HP-AC24V-F | HC2-HP-AC24V-F | HC3-HP-AC24V-F | HC4-HP-AC24V | HC4D-HP-AC24V |
| 48V AC | HC1-HP-AC48V-F | HC2-HP-AC48V-F | HC3-HP-AC48V-F | HC4-HP-AC48V | HC4D-HP-AC48V |
| 100/110V AC | HC1-HP-AC100V-F | HC2-HP-AC100V-F | HC3-HP-AC100V-F | HC4-HP-AC100V | HC4D-HP-AC100V |
| 110/120V AC | HC1-HP-AC120V-F | HC2-HP-AC120V-F | HC3-HP-AC120V-F | HC4-HP-AC120V | HC4D-HP-AC120V |
| 200/220V AC | HC1-HP-AC200V-F | HC2-HP-AC200V-F | HC3-HP-AC200V-F | HC4-HP-AC200V | HC4D-HP-AC200V |
| 220/240V AC | HC1-HP-AC240V-F | HC2-HP-AC240V-F | HC3-HP-AC240V-F | HC4-HP-AC240V | HC4D-HP-AC240V |
| 6V DC | HC1-HP-DC6V-F | HC2-HP-DC6V-F | HC3-HP-DC6V-F | HC4-HP-DC6V | HC4D-HP-DC6V |
| 12V DC | HC1-HP-DC12V-F | HC2-HP-DC12V-F | HC3-HP-DC12V-F | HC4-HP-DC12V | HC4D-HP-DC12V |
| 24V DC | HC1-HP-DC24V-F | HC2-HP-DC24V-F | HC3-HP-DC24V-F | HC4-HP-DC24V | HC4D-HP-DC24V |
| 48V DC | HC1-HP-DC48V-F | HC2-HP-DC48V-F | HC3-HP-DC48V-F | HC4-HP-DC48V | HC4D-HP-DC48V |
| 100/110V DC | HC1-HP-DC100V-F | HC2-HP-DC100V-F | HC3-HP-DC100V-F | HC4-HP-DC100V | HC4D-HP-DC100V |

Standard packing: Carton: 20 pcs.; Case: 200 pcs.

Note: Please add "-31" before "-F" in the part number when ordering the PC board type 0.9 mm width terminal (ex) HC1-HP-AC6V-31-F.

4) PC board type (with LED indication)

| Nominal coil voltage | 1 Form C | 2 Form C | 3 Form C | 4 Form C | 4 Form C (twin) |
|----------------------|------------------|------------------|------------------|----------------|-----------------|
| | Part No. | Part No. | Part No. | Part No. | Part No. |
| 6V AC | HC1-HPL-AC6V-F | HC2-HPL-AC6V-F | HC3-HPL-AC6V-F | HC4-HPL-AC6V | HC4D-HPL-AC6V |
| 12V AC | HC1-HPL-AC12V-F | HC2-HPL-AC12V-F | HC3-HPL-AC12V-F | HC4-HPL-AC12V | HC4D-HPL-AC12V |
| 24V AC | HC1-HPL-AC24V-F | HC2-HPL-AC24V-F | HC3-HPL-AC24V-F | HC4-HPL-AC24V | HC4D-HPL-AC24V |
| 100/110V AC | HC1-HPL-AC100V-F | HC2-HPL-AC100V-F | HC3-HPL-AC100V-F | HC4-HPL-AC100V | HC4D-HPL-AC100V |
| 110/120V AC | HC1-HPL-AC120V-F | HC2-HPL-AC120V-F | HC3-HPL-AC120V-F | HC4-HPL-AC120V | HC4D-HPL-AC120V |
| 200/220V AC | HC1-HPL-AC200V-F | HC2-HPL-AC200V-F | HC3-HPL-AC200V-F | HC4-HPL-AC200V | HC4D-HPL-AC200V |
| 6V DC | HC1-HPL-DC6V-F | HC2-HPL-DC6V-F | HC3-HPL-DC6V-F | HC4-HPL-DC6V | HC4D-HPL-DC6V |
| 12V DC | HC1-HPL-DC12V-F | HC2-HPL-DC12V-F | HC3-HPL-DC12V-F | HC4-HPL-DC12V | HC4D-HPL-DC12V |
| 24V DC | HC1-HPL-DC24V-F | HC2-HPL-DC24V-F | HC3-HPL-DC24V-F | HC4-HPL-DC24V | HC4D-HPL-DC24V |
| 48V DC | HC1-HPL-DC48V-F | HC2-HPL-DC48V-F | HC3-HPL-DC48V-F | HC4-HPL-DC48V | HC4D-HPL-DC48V |
| 100/110V DC | HC1-HPL-DC100V-F | HC2-HPL-DC100V-F | HC3-HPL-DC100V-F | HC4-HPL-DC100V | HC4D-HPL-DC100V |

Standard packing: Carton: 20 pcs.; Case: 200 pcs.

Note: Please add "-31" before "-F" in the part number when ordering the PC board type 0.9 mm width terminal (ex) HC1-HPL-AC6V-31-F.

5) TM type

| Nominal coil voltage | 1 Form C | 2 Form C | 3 Form C | 4 Form C | 4 Form C (twin) |
|----------------------|------------------|------------------|------------------|----------------|-----------------|
| | Part No. | Part No. | Part No. | Part No. | Part No. |
| 6V AC | HC1-HTM-AC6V-F | HC2-HTM-AC6V-F | HC3-HTM-AC6V-F | HC4-HTM-AC6V | HC4D-HTM-AC6V |
| 12V AC | HC1-HTM-AC12V-F | HC2-HTM-AC12V-F | HC3-HTM-AC12V-F | HC4-HTM-AC12V | HC4D-HTM-AC12V |
| 24V AC | HC1-HTM-AC24V-F | HC2-HTM-AC24V-F | HC3-HTM-AC24V-F | HC4-HTM-AC24V | HC4D-HTM-AC24V |
| 48V AC | HC1-HTM-AC48V-F | HC2-HTM-AC48V-F | HC3-HTM-AC48V-F | HC4-HTM-AC48V | HC4D-HTM-AC48V |
| 100/110V AC | HC1-HTM-AC100V-F | HC2-HTM-AC100V-F | HC3-HTM-AC100V-F | HC4-HTM-AC100V | HC4D-HTM-AC100V |
| 110/120V AC | HC1-HTM-AC120V-F | HC2-HTM-AC120V-F | HC3-HTM-AC120V-F | HC4-HTM-AC120V | HC4D-HTM-AC120V |
| 200/220V AC | HC1-HTM-AC200V-F | HC2-HTM-AC200V-F | HC3-HTM-AC200V-F | HC4-HTM-AC200V | HC4D-HTM-AC200V |
| 6V DC | HC1-HTM-DC6V-F | HC2-HTM-DC6V-F | HC3-HTM-DC6V-F | HC4-HTM-DC6V | HC4D-HTM-DC6V |
| 12V DC | HC1-HTM-DC12V-F | HC2-HTM-DC12V-F | HC3-HTM-DC12V-F | HC4-HTM-DC12V | HC4D-HTM-DC12V |
| 24V DC | HC1-HTM-DC24V-F | HC2-HTM-DC24V-F | HC3-HTM-DC24V-F | HC4-HTM-DC24V | HC4D-HTM-DC24V |
| 48V DC | HC1-HTM-DC48V-F | HC2-HTM-DC48V-F | HC3-HTM-DC48V-F | HC4-HTM-DC48V | HC4D-HTM-DC48V |
| 100/110V DC | HC1-HTM-DC100V-F | HC2-HTM-DC100V-F | HC3-HTM-DC100V-F | HC4-HTM-DC100V | HC4D-HTM-DC100V |

Standard packing: Carton: 20 pcs.; Case: 200 pcs.

2. Amber sealed type

1) Plug-in type

| Nominal coil voltage | 1 Form C | 2 Form C | 4 Form C | 4 Form C (twin) |
|----------------------|-----------------|-----------------|---------------|-----------------|
| | Part No. | Part No. | Part No. | Part No. |
| 6V AC | HC1E-H-AC6V-F | HC2E-H-AC6V-F | HC4E-H-AC6V | HC4ED-H-AC6V |
| 12V AC | HC1E-H-AC12V-F | HC2E-H-AC12V-F | HC4E-H-AC12V | HC4ED-H-AC12V |
| 24V AC | HC1E-H-AC24V-F | HC2E-H-AC24V-F | HC4E-H-AC24V | HC4ED-H-AC24V |
| 48V AC | HC1E-H-AC48V-F | HC2E-H-AC48V-F | HC4E-H-AC48V | HC4ED-H-AC48V |
| 100/110V AC | HC1E-H-AC100V-F | HC2E-H-AC100V-F | HC4E-H-AC100V | HC4ED-H-AC100V |
| 110/120V AC | HC1E-H-AC120V-F | HC2E-H-AC120V-F | HC4E-H-AC120V | HC4ED-H-AC120V |
| 200/220V AC | HC1E-H-AC200V-F | HC2E-H-AC200V-F | HC4E-H-AC200V | HC4ED-H-AC200V |
| 220/240V AC | HC1E-H-AC240V-F | HC2E-H-AC240V-F | HC4E-H-AC240V | HC4ED-H-AC240V |
| 6V DC | HC1E-H-DC6V-F | HC2E-H-DC6V-F | HC4E-H-DC6V | HC4ED-H-DC6V |
| 12V DC | HC1E-H-DC12V-F | HC2E-H-DC12V-F | HC4E-H-DC12V | HC4ED-H-DC12V |
| 24V DC | HC1E-H-DC24V-F | HC2E-H-DC24V-F | HC4E-H-DC24V | HC4ED-H-DC24V |
| 48V DC | HC1E-H-DC48V-F | HC2E-H-DC48V-F | HC4E-H-DC48V | HC4ED-H-DC48V |
| 100/110V DC | HC1E-H-DC100V-F | HC2E-H-DC100V-F | HC4E-H-DC100V | HC4ED-H-DC100V |

Standard packing: Carton: 20 pcs.; Case: 200 pcs.

2) Plug-in type (With LED indication)

| Nominal coil voltage | 1 Form C | 2 Form C | 4 Form C | 4 Form C (twin) |
|----------------------|-----------------|-----------------|---------------|-----------------|
| | Part No. | Part No. | Part No. | Part No. |
| 6V AC | HC1E-L-AC6V-F | HC2E-L-AC6V-F | HC4E-L-AC6V | HC4ED-L-AC6V |
| 12V AC | HC1E-L-AC12V-F | HC2E-L-AC12V-F | HC4E-L-AC12V | HC4ED-L-AC12V |
| 24V AC | HC1E-L-AC24V-F | HC2E-L-AC24V-F | HC4E-L-AC24V | HC4ED-L-AC24V |
| 48V AC | HC1E-L-AC48V-F | HC2E-L-AC48V-F | HC4E-L-AC48V | HC4ED-L-AC48V |
| 100/110V AC | HC1E-L-AC100V-F | HC2E-L-AC100V-F | HC4E-L-AC100V | HC4ED-L-AC100V |
| 110/120V AC | HC1E-L-AC120V-F | HC2E-L-AC120V-F | HC4E-L-AC120V | HC4ED-L-AC120V |
| 200/220V AC | HC1E-L-AC200V-F | HC2E-L-AC200V-F | HC4E-L-AC200V | HC4ED-L-AC200V |
| 220/240V AC | HC1E-L-AC240V-F | HC2E-L-AC240V-F | HC4E-L-AC240V | HC4ED-L-AC240V |
| 6V DC | HC1E-L-DC6V-F | HC2E-L-DC6V-F | HC4E-L-DC6V | HC4ED-L-DC6V |
| 12V DC | HC1E-L-DC12V-F | HC2E-L-DC12V-F | HC4E-L-DC12V | HC4ED-L-DC12V |
| 24V DC | HC1E-L-DC24V-F | HC2E-L-DC24V-F | HC4E-L-DC24V | HC4ED-L-DC24V |
| 48V DC | HC1E-L-DC48V-F | HC2E-L-DC48V-F | HC4E-L-DC48V | HC4ED-L-DC48V |
| 100/110V DC | HC1E-L-DC100V-F | HC2E-L-DC100V-F | HC4E-L-DC100V | HC4ED-L-DC100V |

Standard packing: Carton: 20 pcs.; Case: 200 pcs.

3) PC board type

| Nominal coil voltage | 1 Form C | 2 Form C | 4 Form C | 4 Form C (twin) |
|----------------------|------------------|------------------|----------------|-----------------|
| | Part No. | Part No. | Part No. | Part No. |
| 6V AC | HC1E-HP-AC6V-F | HC2E-HP-AC6V-F | HC4E-HP-AC6V | HC4ED-HP-AC6V |
| 12V AC | HC1E-HP-AC12V-F | HC2E-HP-AC12V-F | HC4E-HP-AC12V | HC4ED-HP-AC12V |
| 24V AC | HC1E-HP-AC24V-F | HC2E-HP-AC24V-F | HC4E-HP-AC24V | HC4ED-HP-AC24V |
| 48V AC | HC1E-HP-AC48V-F | HC2E-HP-AC48V-F | HC4E-HP-AC48V | HC4ED-HP-AC48V |
| 100/110V AC | HC1E-HP-AC100V-F | HC2E-HP-AC100V-F | HC4E-HP-AC100V | HC4ED-HP-AC100V |
| 110/120V AC | HC1E-HP-AC120V-F | HC2E-HP-AC120V-F | HC4E-HP-AC120V | HC4ED-HP-AC120V |
| 200/220V AC | HC1E-HP-AC200V-F | HC2E-HP-AC200V-F | HC4E-HP-AC200V | HC4ED-HP-AC200V |
| 220/240V AC | HC1E-HP-AC240V-F | HC2E-HP-AC240V-F | HC4E-HP-AC240V | HC4ED-HP-AC240V |
| 6V DC | HC1E-HP-DC6V-F | HC2E-HP-DC6V-F | HC4E-HP-DC6V | HC4ED-HP-DC6V |
| 12V DC | HC1E-HP-DC12V-F | HC2E-HP-DC12V-F | HC4E-HP-DC12V | HC4ED-HP-DC12V |
| 24V DC | HC1E-HP-DC24V-F | HC2E-HP-DC24V-F | HC4E-HP-DC24V | HC4ED-HP-DC24V |
| 48V DC | HC1E-HP-DC48V-F | HC2E-HP-DC48V-F | HC4E-HP-DC48V | HC4ED-HP-DC48V |
| 100/110V DC | HC1E-HP-DC100V-F | HC2E-HP-DC100V-F | HC4E-HP-DC100V | HC4ED-HP-DC100V |

Standard packing: Carton: 20 pcs.; Case: 200 pcs.

Note: Please add "-31" in the suffix of part number when ordering the PC board type 0.9 mm width terminal. (4 Form C, 4 Form C (twin) only)

HC

4) PC board type (With LED indication)

| Nominal coil voltage | 1 Form C | 2 Form C | 4 Form C | 4 Form C (twin) |
|----------------------|------------------|------------------|----------------|-----------------|
| | Part No. | Part No. | Part No. | Part No. |
| 6V AC | HC1E-PL-AC6V-F | HC2E-PL-AC6V-F | HC4E-PL-AC6V | HC4ED-PL-AC6V |
| 12V AC | HC1E-PL-AC12V-F | HC2E-PL-AC12V-F | HC4E-PL-AC12V | HC4ED-PL-AC12V |
| 24V AC | HC1E-PL-AC24V-F | HC2E-PL-AC24V-F | HC4E-PL-AC24V | HC4ED-PL-AC24V |
| 48V AC | HC1E-PL-AC48V-F | HC2E-PL-AC48V-F | HC4E-PL-AC48V | HC4ED-PL-AC48V |
| 100/110V AC | HC1E-PL-AC100V-F | HC2E-PL-AC100V-F | HC4E-PL-AC100V | HC4ED-PL-AC100V |
| 110/120V AC | HC1E-PL-AC120V-F | HC2E-PL-AC120V-F | HC4E-PL-AC120V | HC4ED-PL-AC120V |
| 200/220V AC | HC1E-PL-AC200V-F | HC2E-PL-AC200V-F | HC4E-PL-AC200V | HC4ED-PL-AC200V |
| 220/240V AC | HC1E-PL-AC240V-F | HC2E-PL-AC240V-F | HC4E-PL-AC240V | HC4ED-PL-AC240V |
| 6V DC | HC1E-PL-DC6V-F | HC2E-PL-DC6V-F | HC4E-PL-DC6V | HC4ED-PL-DC6V |
| 12V DC | HC1E-PL-DC12V-F | HC2E-PL-DC12V-F | HC4E-PL-DC12V | HC4ED-PL-DC12V |
| 24V DC | HC1E-PL-DC24V-F | HC2E-PL-DC24V-F | HC4E-PL-DC24V | HC4ED-PL-DC24V |
| 48V DC | HC1E-PL-DC48V-F | HC2E-PL-DC48V-F | HC4E-PL-DC48V | HC4ED-PL-DC48V |
| 100/110V DC | HC1E-PL-DC100V-F | HC2E-PL-DC100V-F | HC4E-PL-DC100V | HC4ED-PL-DC100V |

Standard packing: Carton: 20 pcs.; Case: 200 pcs.

Note: Please add "-31" in the suffix of part number when ordering the PC board type 0.9 mm width terminal. (4 Form C, 4 Form C (twin) only)

5) TM type

| Nominal coil voltage | 1 Form C | 2 Form C | 4 Form C | 4 Form C (twin) |
|----------------------|-------------------|-------------------|-----------------|------------------|
| | Part No. | Part No. | Part No. | Part No. |
| 6V AC | HC1E-HTM-AC6V-F | HC2E-HTM-AC6V-F | HC4E-HTM-AC6V | HC4ED-HTM-AC6V |
| 12V AC | HC1E-HTM-AC12V-F | HC2E-HTM-AC12V-F | HC4E-HTM-AC12V | HC4ED-HTM-AC12V |
| 24V AC | HC1E-HTM-AC24V-F | HC2E-HTM-AC24V-F | HC4E-HTM-AC24V | HC4ED-HTM-AC24V |
| 48V AC | HC1E-HTM-AC48V-F | HC2E-HTM-AC48V-F | HC4E-HTM-AC48V | HC4ED-HTM-AC48V |
| 100/110V AC | HC1E-HTM-AC100V-F | HC2E-HTM-AC100V-F | HC4E-HTM-AC100V | HC4ED-HTM-AC100V |
| 110/120V AC | HC1E-HTM-AC120V-F | HC2E-HTM-AC120V-F | HC4E-HTM-AC120V | HC4ED-HTM-AC120V |
| 200/220V AC | HC1E-HTM-AC200V-F | HC2E-HTM-AC200V-F | HC4E-HTM-AC200V | HC4ED-HTM-AC200V |
| 220/240V AC | HC1E-HTM-AC240V-F | HC2E-HTM-AC240V-F | HC4E-HTM-AC240V | HC4ED-HTM-AC240V |
| 6V DC | HC1E-HTM-DC6V-F | HC2E-HTM-DC6V-F | HC4E-HTM-DC6V | HC4ED-HTM-DC6V |
| 12V DC | HC1E-HTM-DC12V-F | HC2E-HTM-DC12V-F | HC4E-HTM-DC12V | HC4ED-HTM-DC12V |
| 24V DC | HC1E-HTM-DC24V-F | HC2E-HTM-DC24V-F | HC4E-HTM-DC24V | HC4ED-HTM-DC24V |
| 48V DC | HC1E-HTM-DC48V-F | HC2E-HTM-DC48V-F | HC4E-HTM-DC48V | HC4ED-HTM-DC48V |
| 100/110V DC | HC1E-HTM-DC100V-F | HC2E-HTM-DC100V-F | HC4E-HTM-DC100V | HC4ED-HTM-DC100V |

Standard packing: Carton: 20 pcs.; Case: 200 pcs.

3. Keep relay

| Nominal coil voltage | Plug-in type (2c) | PC board type (2c) |
|----------------------|-------------------|--------------------|
| | Part No. | Part No. |
| 6V AC | HC2K-AC6V-F | HC2K-P-AC6V-F |
| 12V AC | HC2K-AC12V-F | HC2K-P-AC12V-F |
| 24V AC | HC2K-AC24V-F | HC2K-P-AC24V-F |
| 48V AC | HC2K-AC48V-F | HC2K-P-AC48V-F |
| 100V AC | HC2K-AC100V-F | HC2K-P-AC100V-F |
| 6V DC | HC2K-DC6V-F | HC2K-P-DC6V-F |
| 12V DC | HC2K-DC12V-F | HC2K-P-DC12V-F |
| 24V DC | HC2K-DC24V-F | HC2K-P-DC24V-F |
| 48V DC | HC2K-DC48V-F | HC2K-P-DC48V-F |
| 100/110V DC | HC2K-DC100V-F | HC2K-P-DC100V-F |

Standard packing: Carton: 20 pcs.; Case: 200 pcs.

Note: Please refer to the "Standards Chart" for product certification.

4. With diode type (For DC)

1) Plug-in type

| Nominal coil voltage | 1 Form C | 2 Form C | 3 Form C | 4 Form C | 4 Form C (twin) |
|----------------------|----------------|----------------|----------------|--------------|-----------------|
| | Part No. | Part No. | Part No. | Part No. | Part No. |
| 6V DC | HC1-DC6V-D-F | HC2-DC6V-D-F | HC3-DC6V-D-F | HC4-DC6V-D | HC4D-DC6V-D |
| 12V DC | HC1-DC12V-D-F | HC2-DC12V-D-F | HC3-DC12V-D-F | HC4-DC12V-D | HC4D-DC12V-D |
| 24V DC | HC1-DC24V-D-F | HC2-DC24V-D-F | HC3-DC24V-D-F | HC4-DC24V-D | HC4D-DC24V-D |
| 48V DC | HC1-DC48V-D-F | HC2-DC48V-D-F | HC3-DC48V-D-F | HC4-DC48V-D | HC4D-DC48V-D |
| 100/110V DC | HC1-DC100V-D-F | HC2-DC100V-D-F | HC3-DC100V-D-F | HC4-DC100V-D | HC4D-DC100V-D |

Standard packing: Carton: 20 pcs.; Case: 200 pcs.

2) Plug-in type (with LED indication)

| Nominal coil voltage | 1 Form C | 2 Form C | 3 Form C | 4 Form C | 4 Form C (twin) |
|----------------------|------------------|------------------|------------------|----------------|-----------------|
| | Part No. | Part No. | Part No. | Part No. | Part No. |
| 6V DC | HC1-L-DC6V-D-F | HC2-L-DC6V-D-F | HC3-L-DC6V-D-F | HC4-L-DC6V-D | HC4D-L-DC6V-D |
| 12V DC | HC1-L-DC12V-D-F | HC2-L-DC12V-D-F | HC3-L-DC12V-D-F | HC4-L-DC12V-D | HC4D-L-DC12V-D |
| 24V DC | HC1-L-DC24V-D-F | HC2-L-DC24V-D-F | HC3-L-DC24V-D-F | HC4-L-DC24V-D | HC4D-L-DC24V-D |
| 48V DC | HC1-L-DC48V-D-F | HC2-L-DC48V-D-F | HC3-L-DC48V-D-F | HC4-L-DC48V-D | HC4D-L-DC48V-D |
| 100/110V DC | HC1-L-DC100V-D-F | HC2-L-DC100V-D-F | HC3-L-DC100V-D-F | HC4-L-DC100V-D | HC4D-L-DC100V-D |

Standard packing: Carton: 20 pcs.; Case: 200 pcs.

5. With CR circuit type

1) Plug-in type

| Nominal coil voltage | 1 Form C | 2 Form C | 3 Form C | 4 Form C | 4 Form C (twin) |
|----------------------|----------------|----------------|----------------|--------------|-----------------|
| | Part No. | Part No. | Part No. | Part No. | Part No. |
| 100/110V AC | HC1-AC100V-R-F | HC2-AC100V-R-F | HC3-AC100V-R-F | HC4-AC100V-R | HC4D-AC100V-R |
| 110/120V AC | HC1-AC120V-R-F | HC2-AC120V-R-F | HC3-AC120V-R-F | HC4-AC120V-R | HC4D-AC120V-R |
| 200/220V AC | HC1-AC200V-R-F | HC2-AC200V-R-F | HC3-AC200V-R-F | HC4-AC200V-R | HC4D-AC200V-R |
| 220/240V AC | HC1-AC240V-R-F | HC2-AC240V-R-F | HC3-AC240V-R-F | HC4-AC240V-R | HC4D-AC240V-R |

Standard packing: Carton: 20 pcs.; Case: 200 pcs.

2) Plug-in type (with LED indication)

| Nominal coil voltage | 1 Form C | 2 Form C | 3 Form C | 4 Form C | 4 Form C (twin) |
|----------------------|------------------|------------------|------------------|----------------|-----------------|
| | Part No. | Part No. | Part No. | Part No. | Part No. |
| 100/110V AC | HC1-L-AC100V-R-F | HC2-L-AC100V-R-F | HC3-L-AC100V-R-F | HC4-L-AC100V-R | HC4D-L-AC100V-R |
| 110/120V AC | HC1-L-AC120V-R-F | HC2-L-AC120V-R-F | HC3-L-AC120V-R-F | HC4-L-AC120V-R | HC4D-L-AC120V-R |
| 200/220V AC | HC1-L-AC200V-R-F | HC2-L-AC200V-R-F | HC3-L-AC200V-R-F | HC4-L-AC200V-R | HC4D-L-AC200V-R |
| 220/240V AC | HC1-L-AC240V-R-F | HC2-L-AC240V-R-F | HC3-L-AC240V-R-F | HC4-L-AC240V-R | HC4D-L-AC240V-R |

Standard packing: Carton: 20 pcs.; Case: 200 pcs.

* For sockets and terminal sockets, see page 87.

RATING

1. Standard type

1) Coil data

(1) AC coils (50/60Hz)

| Type | Nominal coil voltage | Pick-up voltage (at 20°C 68°F) | Drop-out voltage (at 20°C 68°F) | Nominal coil current [±20%] (at 20°C 68°F) | | Coil inductance | | Nominal operating power | | Max. applied voltage (at 70°C 158°F) |
|----------|----------------------|---|---|--|-------------|-----------------|----------------|-------------------------|-------|--------------------------------------|
| | | | | 50Hz | 60Hz | N.C. condition | N.O. condition | 50Hz | 60Hz | |
| Standard | 6V AC | 80%V or less of nominal voltage (Initial) | 30%V or more of nominal voltage (Initial) | 224mA | 200mA | 0.078H | 0.074H | 1.3VA | 1.2VA | 110%V of nominal voltage |
| | 12V AC | | | 111mA | 100mA | 0.312H | 0.295H | | | |
| | 24V AC | | | 56mA | 50mA | 1.243H | 1.181H | | | |
| | 48V AC | | | 28mA | 25mA | 4.974H | 4.145H | | | |
| | 100/110V AC | | | 13.4/14.7mA | 12/13.2mA | 23.75H | 20.63H | | | |
| | 110/120V AC | | | 12.2/13.5mA | 10.9/11.9mA | 27.19H | 25.57H | | | |
| | 200/220V AC | | | 6.7/7.4mA | 6/6.6mA | 85.98H | 81.76H | | | |

Notes: 1. The relay operates in a range of 80% to 110% V of the voltage rating, but ideally, in consideration of temporary voltage fluctuations, it should be operated at the rated voltage. In particular, for AC operation, if the applied voltage drops to 80% V or more below the rated voltage, humming will occur and a large current will flow leading possibly to coil burnout.

2. The maximum applied voltage is the maximum voltage fluctuation value for the coil power supply. This value is not a permissible value for continuous operation. (This value differs depending on the ambient temperature. Please contact us for details.)

HC

(2) DC coils

| Type | Nominal coil voltage | Pick-up voltage (at 20°C 68°F) | Drop-out voltage (at 20°C 68°F) | Nominal coil current [±10%] (at 20°C 68°F) | Coil resistance [±10%] (at 20°C 68°F) | Nominal operating power | Max. applied voltage (at 70°C 158°F) |
|----------|----------------------|---|---|--|---------------------------------------|-------------------------|--------------------------------------|
| Standard | 6V DC | 80%V or less of nominal voltage (Initial) | 10%V or more of nominal voltage (Initial) | 150mA | 40Ω | 0.9W | 110%V of nominal voltage |
| | 12V DC | | | 75mA | 160Ω | | |
| | 24V DC | | | 37mA | 650Ω | | |
| | 48V DC | | | 18.5mA | 2,600Ω | | |
| | 100/110V DC | | | 10/11mA | 10,000Ω | 1.0W | |

- Notes: 1. The coil resistance for DC operation is the value measured when the coil temperature is 20°C 68°F. Compensate ±0.4% for every ±1°C change in temperature.
 2. The relay operates in a range of 80% to 110% V of the voltage rating, but ideally, in consideration of temporary voltage fluctuations, it should be operated at the rated voltage.
 3. For use with 200 V DC, connect a 10 KΩ (5W) resistor, in series, to the 100 V DC relay.
 4. The maximum applied voltage is the maximum voltage fluctuation value for the coil power supply. This value is not a permissible value for continuous operation. (This value differs depending on the ambient temperature. Please contact us for details.)

2) Specifications

| Characteristics | Item | Specifications | | | | |
|-------------------------------|--|--|--|--|--|--|
| | | 1 Form C | 2 Form C | 3 Form C | 4 Form C | 4 Form C (twin) |
| Contact | Arrangement | | | | | |
| | Contact resistance (Initial) | Max. 30 mΩ (By voltage drop 6 V DC 1A) | | | | |
| | Contact material | Ag alloy (cd free) + Au flash | | | AgNi type + Au clad | |
| Rating | Nominal switching capacity (resistive load) | 10A 250V AC | 7A 250V AC | 7A 250V AC | 5A 250V AC | 3A 250V AC |
| | Max. switching power (resistive load) | 2,500VA | 1,750VA | 1,750VA | 1,250VA | 750VA |
| | Max. switching voltage | 250VAC | | | | |
| | Max. switching current | 10A | 7A | 7A | 5A | 3A |
| | Nominal operating power | AC (50Hz): 1.3VA, AC (60Hz): 1.2VA, DC: 0.9 to 1.1W | | | | |
| | Min. switching capacity (Reference value)*1 | 1mA 1V DC | | | | 100μA 1V DC |
| Electrical characteristics | Insulation resistance (Initial) | Min. 1,000MΩ (at 500V DC) Measurement at same location as "Breakdown voltage" section. | | | | |
| | Breakdown voltage (Initial) | Between open contacts | 700 Vrms for 1min. (Detection current: 10mA.) | | | |
| | | Between contact sets | 700 Vrms for 1min. (Detection current: 10mA.) | | | |
| | | Between contact and coil | 2,000 Vrms for 1min. (Detection current: 10mA.) | | | |
| | Temperature rise (coil) (at 70°C 158°F) | Max. 80°C 176°F (By resistive method, nominal coil voltage) | | | | |
| | Operate time (at 20°C 68°F)*2 | Max. 20ms (Nominal coil voltage applied to the coil, excluding contact bounce time.) | | | | |
| Release time (at 20°C 68°F)*2 | Max. 20ms (Nominal coil voltage applied to the coil, excluding contact bounce time.) (without diode) | | | | | |
| Mechanical characteristics | Shock resistance | Functional | Min. 196 m/s ² (Half-wave pulse of sine wave: 11 ms; detection time: 10μs.) | | | |
| | | Destructive | Min. 980 m/s ² (Half-wave pulse of sine wave: 6 ms.) | | | |
| | Vibration resistance | Functional | 10 to 55 Hz at double amplitude of 1 mm (Detection time: 10μs.) | | | |
| | | Destructive | 10 to 55 Hz at double amplitude of 2 mm | | | |
| Expected life | Mechanical | Min. 5×10 ⁷ : AC coil type (at 180 times/min.); Min. 10 ⁸ : DC coil type (at 180 times/min.) | | | | |
| | Electrical | Min. 2×10 ⁵ resistive load (at 20 times/min.) | Min. 2×10 ⁵ resistive load (at 20 times/min.) | Min. 10 ⁵ resistive load (at 20 times/min.) | Min. 2×10 ⁵ resistive load (at 20 times/min.) | Min. 2×10 ⁵ resistive load (at 20 times/min.) |
| Conditions | Conditions for operation, transport and storage*3 | Ambient temperature: -50°C to +70°C -58°F to +158°F (without LED); -50°C to +60°C -58°F to +140°F (with LED) Humidity: 5 to 85% R.H. (Not freezing and condensing at low temperature) | | | | |
| | Max. Operating speed | 20 times/min. (at max. rating) | | | | |
| Unit weight | | Approx. 30g 1.06 oz | | | | |

Notes: *1. This value can change due to the switching frequency, environmental conditions and desired reliability level, therefore it is recommended to check this with the actual load.

*2. For the AC coil types, the operate/release time will differ depending on the phase.

*3. The upper limit of the ambient temperature is the maximum temperature that can satisfy the coil temperature rise value. Refer to Usage, transport and storage conditions in NOTES.

3) Switching capacity and expected life

(1) Electrical (at 20 times/min.)

| Load | AC | | | | DC | | Expected life |
|-----------------|-----------------------|---------|-------------------------|---------|-----------|-----------|------------------------|
| | Resistive (cos φ = 1) | | Inductive (cos φ ≅ 0.4) | | Resistive | Inductive | |
| Voltage | 125V AC | 250V AC | 125V AC | 250V AC | 30V DC | 30V DC | |
| 1 Form C | 10A | 10A | 5A | 3A | — | — | Min. 2×10 ⁵ |
| | 7A | 7A | 3A | 2.5A | 3A | 1A | Min. 5×10 ⁵ |
| | 5A | 5A | 2A | 1.5A | — | — | Min. 10 ⁶ |
| 2 Form C | 7A | 7A | 3.5A | 2A | — | — | Min. 2×10 ⁵ |
| | 5A | 5A | 2.5A | 1.5A | 3A | 0.6A | Min. 5×10 ⁵ |
| | 3A | 3A | 1.5A | 1A | — | — | Min. 10 ⁶ |
| 3 Form C | 7A | 7A | — | — | — | — | Min. 10 ⁵ |
| | — | — | 3.5A | 2A | — | — | Min. 2×10 ⁵ |
| | 5A | 5A | — | — | 3A | 0.4A | Min. 5×10 ⁵ |
| 4 Form C | 5A | 5A | 2A | 1A | — | — | Min. 2×10 ⁵ |
| | 3A | 3A | 1A | 0.8A | 3A | 0.4A | Min. 5×10 ⁵ |
| | 2A | 2A | 0.5A | 0.4A | — | — | Min. 10 ⁶ |
| 4 Form C (twin) | 3A | 3A | 1A | 0.8A | 3A | — | Min. 2×10 ⁵ |

(2) Mechanical (at 180 times/min.)

AC coil type: Min. 5×10⁷; DC coil type: Min. 10⁸

2. Amber sealed type

1) Coil data

Same coil data as HC relay standard type. Please refer to standard type information.

2) Specifications

| Characteristics | Item | Specifications | | | |
|----------------------------|---|--|------------|------------|-----------------|
| | | 1 Form C | 2 Form C | 4 Form C | 4 Form C (twin) |
| Contact | Arrangement | 1 Form C | 2 Form C | 4 Form C | 4 Form C |
| Rating | Nominal switching capacity (resistive load) | 5A 250V AC | 3A 250V AC | 2A 250V AC | 1A 250V AC |
| | Max. switching power (resistive load) | 1,250VA | 700VA | 500VA | 250VA |
| | Max. switching voltage | 250VAC | 250VAC | 250VAC | 250VAC |
| | Max. switching current | 5A | 3A | 2A | 1A |
| | Min. switching capacity (Reference value)*1 | 1mA 100mV DC | | | 100μA 100mV DC |
| Electrical characteristics | Temperature rise (coil) (at 60°C 140°F) | Max. 90°C 194°F (By resistive method, nominal voltage) | | | |
| Expected life | Electrical | Min. 2×10 ⁵ resistive load (at 20 times/min.) | | | |
| Conditions | Conditions for operation, transport and storage*2 | Ambient temperature: -40°C to +60°C -40°F to +140°F; Humidity: 5 to 85% R.H. (Not freezing and condensing at low temperature) | | | |
| | Ambient air pressure | 760mmHg±20% (1,013mb±20%) | | | |

Notes: Other specifications are same as standard types.

*1. This value can change due to the switching frequency, environmental conditions and desired reliability level, therefore it is recommended to check this with the actual load.

*2. The upper limit of the ambient temperature is the maximum temperature that can satisfy the coil temperature rise value. Refer to Usage, transport and storage conditions in NOTES.

3) Switching capacity and expected life

(1) Electrical (at 20 times/min.)

| Load | AC | | | | DC | | Expected life |
|-----------------------|-----------------------|---------|-------------------------|---------|-----------|-----------|------------------------|
| | Resistive (cos φ = 1) | | Inductive (cos φ ≅ 0.4) | | Resistive | Inductive | |
| Voltage | 125V AC | 250V AC | 125V AC | 250V AC | 30V DC | 30V DC | |
| HC1E | 5A | 5A | — | — | 3A | 1A | Min. 2×10 ⁵ |
| HC2E | 3A | 3A | — | — | 2A | 0.7A | Min. 2×10 ⁵ |
| HC4E | 2A | 2A | — | — | 2A | 0.6A | Min. 2×10 ⁵ |
| HC4ED (4 Form C twin) | 1A | 1A | — | — | — | — | Min. 2×10 ⁵ |

(2) Mechanical (at 180 times/min.)

AC coil type: Min. 5×10⁷; DC coil type: Min. 10⁸

HC

3. Keep relay

1) Coil data

(1) AC coils (50/60Hz)

| Contact arrangement | Nominal coil voltage | Set voltage (at 20°C 68°F) | Reset voltage (at 20°C 68°F) | Nominal operating current [±10%] (at 20°C 68°F) | | Nominal operating power | | Max. applied voltage (at 50°C 122°F) |
|---------------------|----------------------|---|---|---|------------|-------------------------|------------|--------------------------------------|
| | | | | Set coil | Reset coil | Set coil | Reset coil | |
| 2 Form C | 6V AC | 80%V or less of nominal voltage (Initial) | 80%V or less of nominal voltage (Initial) | 206mA | 103mA | 1.23VA | 0.62VA | 110%V of nominal voltage |
| | 12V AC | | | 100mA | 52mA | 1.20VA | 0.62VA | |
| | 24V AC | | | 51mA | 21.4mA | 1.22VA | 0.51VA | |
| | 48V AC | | | 25.2mA | 18.5mA | 1.20VA | 0.88VA | |
| | 100V AC | | | 13.3mA | 7.1mA | 1.33VA | 0.71VA | |

(2) DC coils

| Contact arrangement | Nominal coil voltage | Set voltage (at 20°C 68°F) | Reset voltage (at 20°C 68°F) | Nominal operating current [±10%] (at 20°C 68°F) | | Coil resistance [±10%] (at 20°C 68°F) | | Nominal operating power | | Max. applied voltage (at 50°C 122°F) |
|---------------------|----------------------|---|---|---|------------|---------------------------------------|------------|-------------------------|------------|--------------------------------------|
| | | | | Set coil | Reset coil | Set coil | Reset coil | Set coil | Reset coil | |
| 2 Form C | 6V DC | 80%V or less of nominal voltage (Initial) | 80%V or less of nominal voltage (Initial) | 207mA | 107mA | 29Ω | 56Ω | 1.24W | 0.64W | 110%V of nominal voltage |
| | 12V DC | | | 100mA | 52.2mA | 120Ω | 230Ω | 1.20W | 0.63W | |
| | 24V DC | | | 51.1mA | 25.5mA | 470Ω | 941Ω | 1.23W | 0.61W | |
| | 48V DC | | | 25.3mA | 13.7mA | 1,897Ω | 3,504Ω | 1.21W | 0.66W | |
| | 100V DC | | | 15.6mA | 5.8mA | 6,410Ω | 17,241Ω | 1.56W | 0.58W | |

Notes: 1. The allowable coil resistance range is ±10% when within 1,000Ω and ±15% when 1,000Ω or higher.

2. The maximum applied voltage is the maximum voltage fluctuation value for the coil power supply. This value is not a permissible value for continuous operation. (This value differs depending on the ambient temperature. Please contact us for details.)

2) Specifications

| Characteristics | Item | Specifications |
|----------------------------|--|--|
| Contact | Contact resistance (Initial) | Max. 50 mΩ (By voltage drop 6 V DC 1A) |
| Rating | Nominal switching capacity (resistive load) | 3A 250V AC |
| | Max. switching power (resistive load) | 750VA |
| | Max. switching current | 3A |
| | Nominal operating power | Set coil: 1.20VA to 1.33VA; Reset coil: 0.51VA to 0.88VA |
| | Min. switching capacity (Reference value)*1 | 100μA 100mV DC |
| Electrical characteristics | Breakdown voltage (Initial) Between contact and coil | 1,500 Vrms for 1min. |
| | Temperature rise (coil) | Set coil: Max. 80°C 176°F; Reset coil: Max. 50°C 122°F (at nominal coil voltage) |
| | Set time/Reset time (at 20°C 68°F) | Approx. 20ms/30ms (at nominal coil voltage) |
| Mechanical characteristics | Shock resistance Functional | Min. 98m/s ² (Half-wave pulse of sine wave: 11 ms; detection time: 10μs.) |
| Expected life | Mechanical | Min. 10 ⁷ (at 180 times/min.) |
| | Electrical | Min. 2×10 ⁵ rated load (at 20 times/min.) |
| Conditions | Ambient temperature | -40°C to +50°C -40°F to +122°F (Not freezing and condensing at low temperature) |

Notes: *1. This value can change due to the switching frequency, environmental conditions and desired reliability level, therefore it is recommended to check this with the actual load.

*2. Other specifications are same as standard type HC relay. Please see the standard type HC relay.

*3. Please maintain (reset) the relay more than once a year. Leaving it in the set position for long periods of time will cause the magnet to attenuate over the years. This will decrease the holding power and cause failure of the set position.

4. With diode type (For DC)

1) Coil data

Same coil data as HC relay standard type for DC. Please refer to standard type information.

Please connect DC coil type built-in diode correctly by verifying the coil polarity.

2) Specifications

| Characteristics | Item | Specifications |
|-----------------|--|---|
| Conditions | Conditions for operation, transport and storage* | Ambient temperature: -50°C to +60°C -58°F to +140°F Humidity: 5 to 85% R.H. (Not freezing and condensing at low temperature) |

Notes: Other specifications are same as standard type HC relay. Please see the standard type HC relay.

* The upper limit of the ambient temperature is the maximum temperature that can satisfy the coil temperature rise value. Refer to Usage, transport and storage conditions in NOTES.

5. With CR circuit type

1) Coil data

Same coil data as HC relay standard type for AC. Please refer to standard type information.

2) Specifications

| Characteristics | Item | Specifications |
|----------------------------|--|---|
| Electrical characteristics | Temperature rise (coil) | Max. 90°C 194°F (By resistive method, nominal voltage, rated current at 60°C 140°F) |
| Conditions | Conditions for operation, transport and storage* | Ambient temperature: -50°C to +60°C -58°F to +140°F Humidity: 5 to 85% R.H. (Not freezing and condensing at low temperature) |

Notes: Other specifications are same as standard type HC relay. Please see the standard type HC relay.

* The upper limit of the ambient temperature is the maximum temperature that can satisfy the coil temperature rise value. Refer to Usage, transport and storage conditions in NOTES.

REFERENCE DATA

Standard type

1. Life curve

Load: 250 V AC resistive load

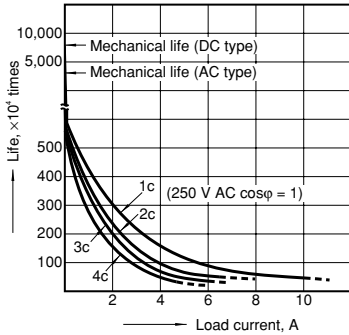

2.-(1) Switching capacity range (single contact type)

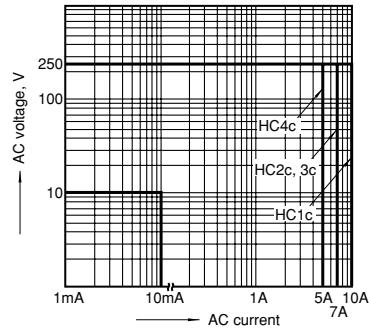

2.-(2) Switching capacity range (4-pole bifurcated (twin) contact type)

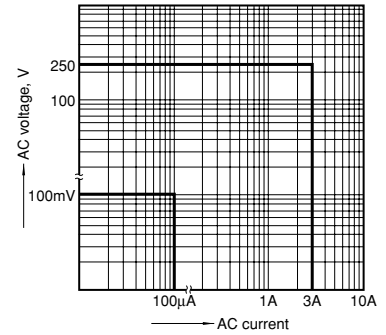

3.-(1) Coil temperature rise (1 Form C, AC type)

Measured portion: Inside the coil
Ambient temperature: 25°C 77°F (See note.)

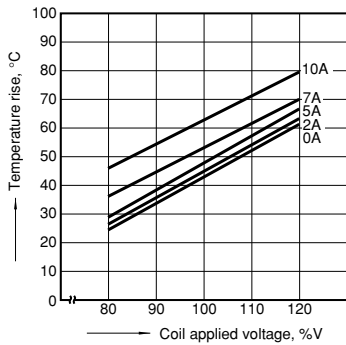

3.-(2) Coil temperature rise (2 Form C, AC type)

Measured portion: Inside the coil
Ambient temperature: 30°C 86°F (See note.)

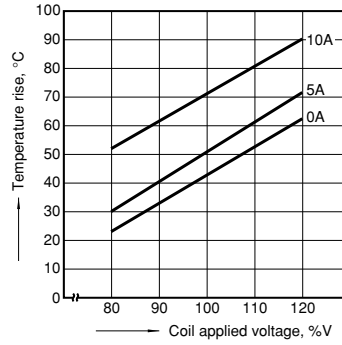

3.-(3) Coil temperature rise (3 Form C, AC type)

Measured portion: Inside the coil
Ambient temperature: 18°C 64°F (See note.)

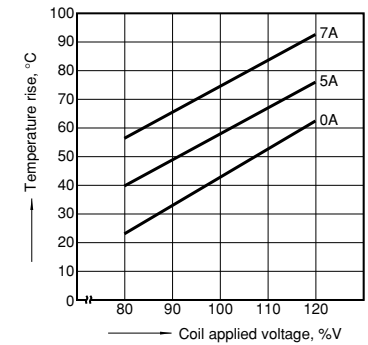

3.-(4) Coil temperature rise (4 Form C, AC type)

Measured portion: Inside the coil
Ambient temperature: 15 to 21°C 59 to 70°F (See note.)

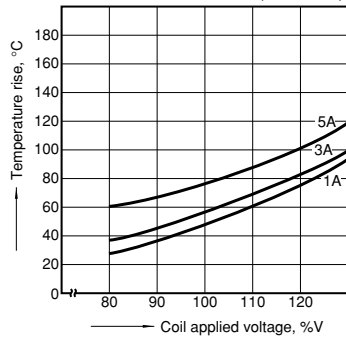

3.-(5) Coil temperature rise (1 Form C, DC type)

Measured portion: Inside the coil
Ambient temperature: 29°C 84°F

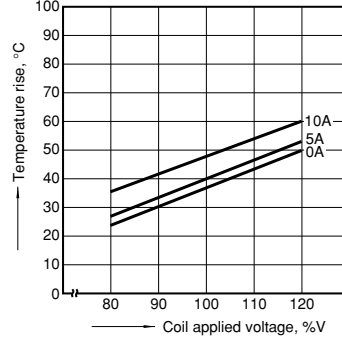

3.-(6) Coil temperature rise (2 Form C, DC type)

Measured portion: Inside the coil
Ambient temperature: 29°C 84°F

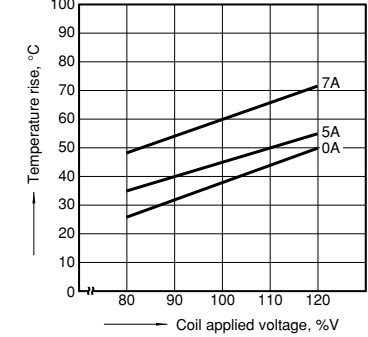

3.-(7) Coil temperature rise (3 Form C, DC type)

Measured portion: Inside the coil
Ambient temperature: 29°C 84°F

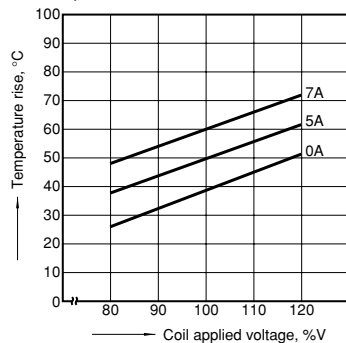

3.-(8) Coil temperature rise (4 Form C, DC type)

Measured portion: Inside the coil
Ambient temperature: 17 to 18°C 62 to 64°F

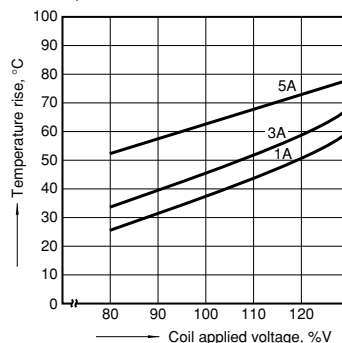

Note: Coil temperature rise

When the nominal voltage is applied to AC 120 or 240 V coil types respectively, the figures of coil temperature rise increase by approx. 10 degrees to the ones shown on each graph.

HC

Amber sealed type

1.-(1) Switching capacity range
(single contact type)

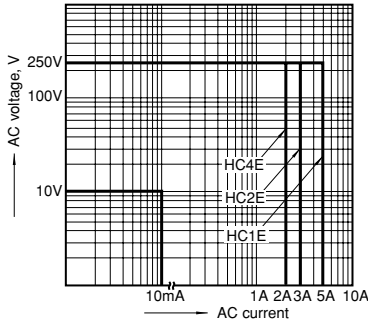

1.-(2) Switching capacity range
(4-pole bifurcated (twin) contact type)

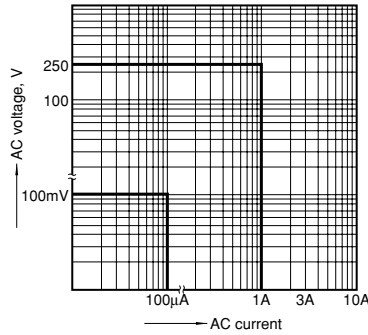

2.-(1) Coil temperature rise (1 Form C AC type)

Measured portion: Inside the coil
Ambient temperature: 30°C 86°F

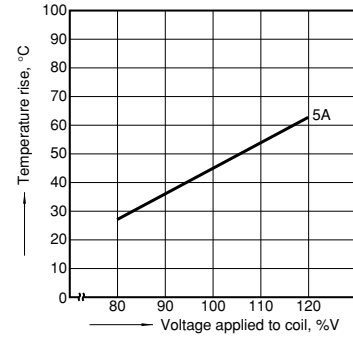

2.-(2) Coil temperature rise (2 Form C AC type)

Measured portion: Inside the coil
Ambient temperature: 30°C 86°F (See note.)

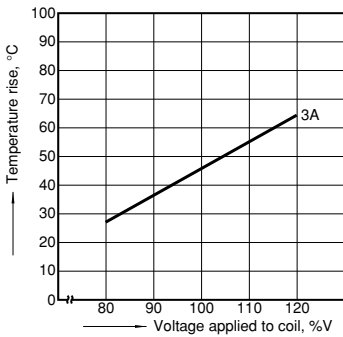

2.-(3) Coil temperature rise (4 Form C AC type)

Measured portion: Inside the coil
Ambient temperature: 30°C 86°F (See note.)

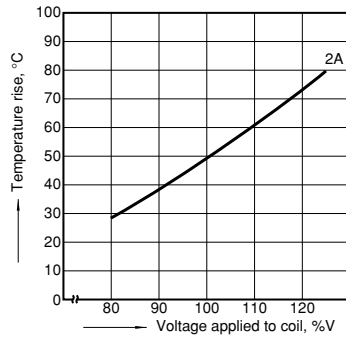

2.-(4) Coil temperature rise (1 Form C DC type)

Measured portion: Inside the coil
Ambient temperature: 30°C 86°F

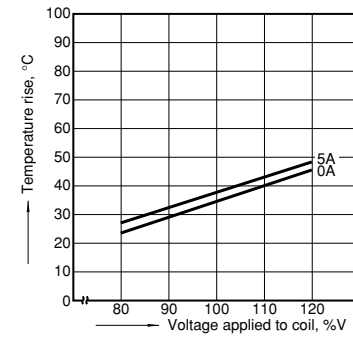

2.-(5) Coil temperature rise (2 Form C DC type)

Measured portion: Inside the coil
Ambient temperature: 30°C 86°F

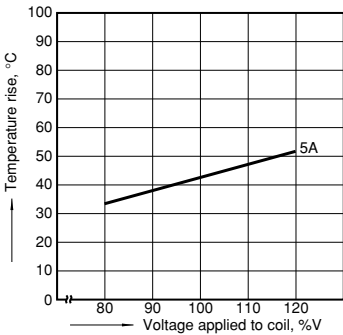

Note: Coil temperature rise

When the nominal voltage is applied to AC 120 or 240 V coil types respectively, the figures of coil temperature rise increase by approx. 10 degrees to the ones shown on each graph.

Keep relay

Coil temperature rise

Tested sample: HC2K-DC12V, 2 pcs

Measured portion: Inside the coil

Ambient temperature: 28°C 82.4°F

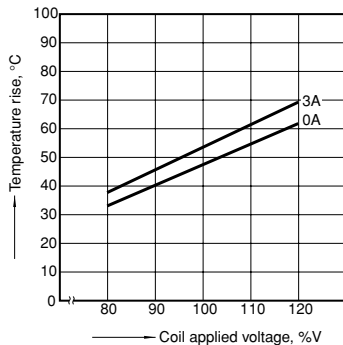

With diode type (For DC)

1.-(1) DC coil surge voltage waveform (without diode)

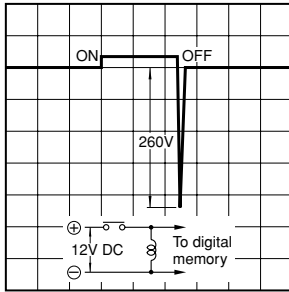

1.-(2) DC coil surge voltage waveform (with diode)

Diode characteristics;
Reverse breakdown voltage: 1,000V,
Forward current: 1A

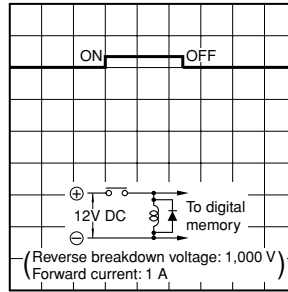

With CR circuit type

1.-(1) AC coil surge voltage waveform (with CR circuit)
Tested sample: HC4-AC200V-R

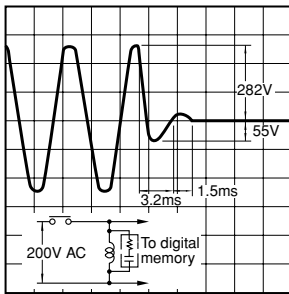

1.-(2) AC coil surge voltage waveform (without CR circuit)
Tested sample: HC4-AC200V

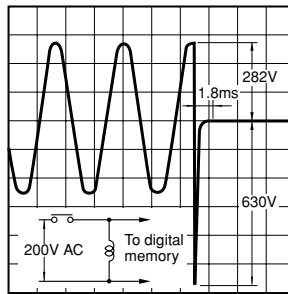

DIMENSIONS (mm inch)

The CAD data of the products with a **CAD Data** mark can be downloaded from: <http://panasonic-electric-works.net/ac>

Standard and Amber sealed types

1) Plug-in type
1 Form C

CAD Data



External dimensions

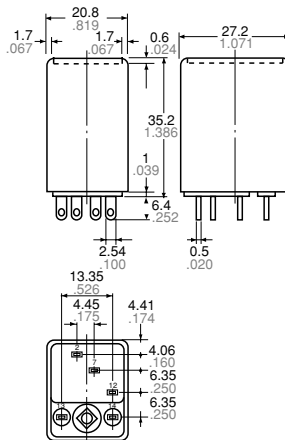

Schematic (Bottom view)

Standard type

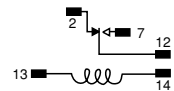

LED AC type

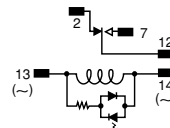

LED DC type

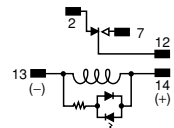

General tolerance: $\pm 0.3 \pm 0.12$

HC

2 Form C

CAD Data



External dimensions

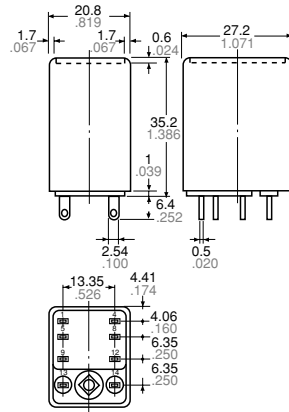

Schematic (Bottom view)

Standard type

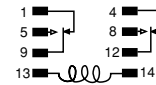

LED AC type

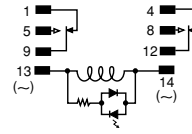

LED DC type

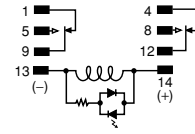

General tolerance: $\pm 0.3 \pm 0.12$

3 Form C

CAD Data



External dimensions

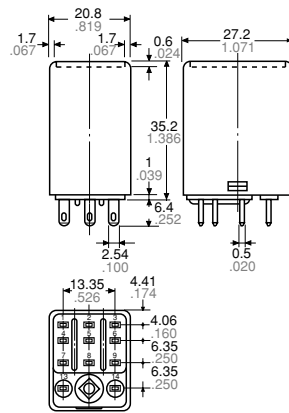

Schematic (Bottom view)

Standard type

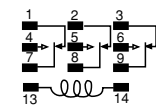

LED AC type

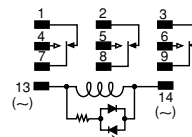

LED DC type

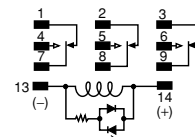

General tolerance: $\pm 0.3 \pm 0.12$

4 Form C and 4-pole bifurcated (twin)

CAD Data



External dimensions

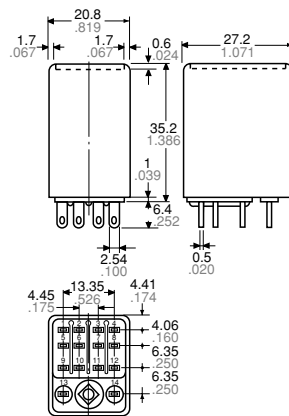

Schematic (Bottom view)

Standard type

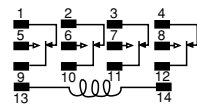

LED AC type

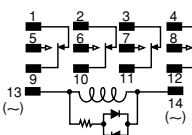

LED DC type

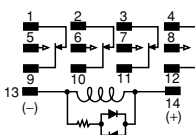

General tolerance: $\pm 0.3 \pm 0.12$

2) PC board type
4 Form C

CAD Data



External dimensions

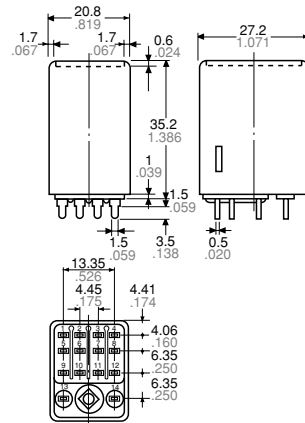

General tolerance: $\pm 0.3 \pm 0.12$

The diagrams show the external dimensions of the 4 Form C and 4-pole bifurcated (twin) types. For 1 Form C, 2 Form C, and 3 Form C, see diagrams at plug-in types (only the terminals are different). Types with 0.9 mm terminal width are also available.

PC board pattern

1 Form C

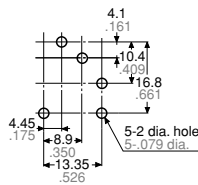

2 Form C

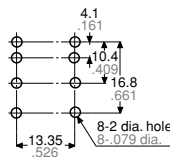

3 Form C

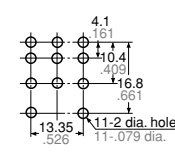

4 Form C

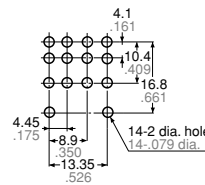

Tolerance: $\pm 0.1 \pm 0.004$

Schematic

Same schematic as plug-in type HC relay

3) TM type
4 Form C

CAD Data

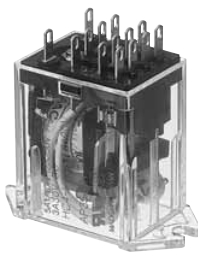

External dimensions

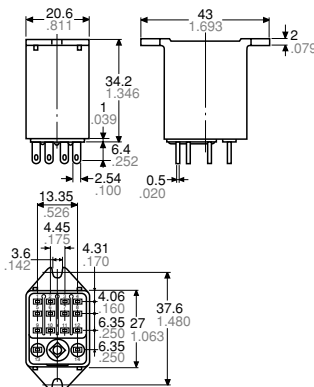

General tolerance: $\pm 0.3 \pm 0.12$

The diagrams show the external dimensions of the 4 Form C and 4-pole bifurcated (twin) types. For 1 Form C, 2 Form C, and 3 Form C, see diagrams at plug-in types (only the terminals are different).

Chassis (Panel) cutout

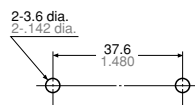

Tolerance: $\pm 0.1 \pm 0.004$

Chassis (Panel) cutout in tandem mounting

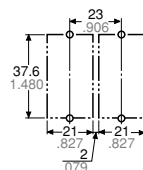

Schematic

Same schematic as plug-in type HC relay
Be aware that there is no LED indicator with CR circuit and built-in diode types.

Notes: 1. In mounting, use M3 screws and M3 washers.

- When mounting TM types, use washers to prevent damage or distortion to the polycarbonate cover.
- When tightening fixing screws, the optimum torque range should be 0.294 to 0.49 N·m, (3 to 5 kgf·cm). Moreover, use washers to prevent loosening.

HC

Keep relay
Plug-in type (2 Form C)

CAD Data

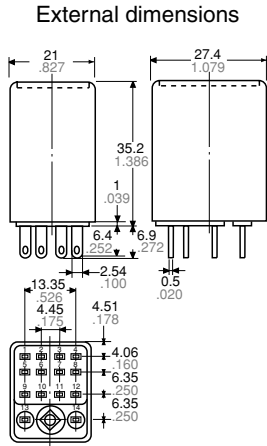

General tolerance: $\pm 0.3 \pm .012$

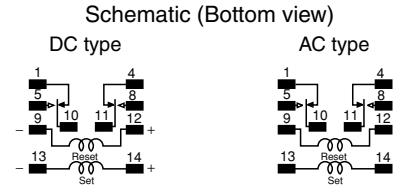

PC board type (2 Form C)

CAD Data

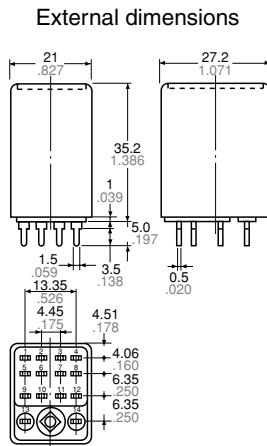

General tolerance: $\pm 0.3 \pm .012$

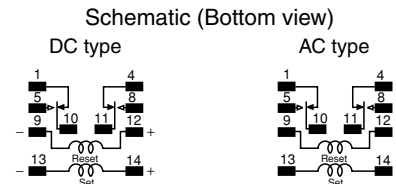

PC board pattern (Bottom view)

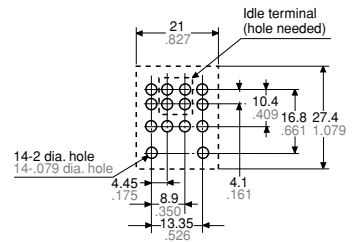

Tolerance: $\pm 0.1 \pm .004$

With diode type (For DC)

Same dimensions as HC relay standard/plug-in type

CAD Data



Schematic

Without LED indicator

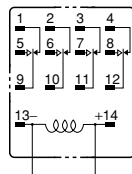

Protection (surge-absorbing) diode

With LED indicator

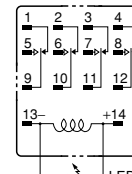

Protection (surge-absorbing) diode

With CR circuit type

Plug-in type

CAD Data



4 Form C External dimensions

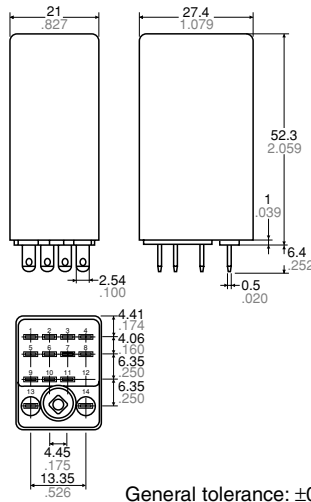

Diagrams show the external dimensions and schematic of the 4 Form C and 4-pole bifurcated (twin) types. For the 1 Form C, 2 Form C, and 3 Form C types, only the terminals differ. The dimensions of the terminal are the same as for standard type HC relays.

Schematic

Without LED indicator With LED indicator

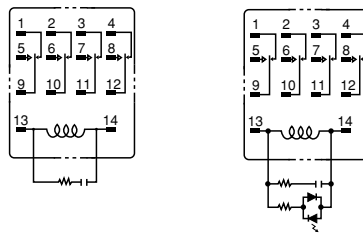

SAFETY STANDARDS

| Item | UL/C-UL (Recognized) | | CSA (Certified) | | VDE (Certified) | | TV rating (UL/CSA) | | Remarks |
|-------------|-----------------------------------|--|-------------------------|--|-----------------|--|--------------------------------|-------------------------|---------|
| | File No. | Contact rating | File No. | Contact rating | File No. | Contact rating | File No. | Rating | |
| HC Standard | 1 Form C | E43028 10A 250V AC 1/8HP 125, 250V AC 3A 30V DC | LR26550 etc. | 10A 250V AC 1/8HP 125, 250V AC 3A 30V DC | 40017406 | 10A 250V AC (cosφ=1.0) 3A 250V AC (cosφ=0.4) 3A 30V DC (0ms) | UL E43149 CSA LR26550 | TV-3 | |
| | 2 Form C | E43028 7A 250V AC 1/16HP 125, 250V AC 3A 30V DC | LR26550 etc. | 7A 250V AC 1/16HP 125, 250V AC 3A 30V DC | 40017406 | 7A 250V AC (cosφ=1.0) 2A 250V AC (cosφ=0.4) 3A 30V DC (0ms) | UL E43149 CSA LR26550 | TV-3 | |
| | 3 Form C | E43028 7A 250V AC 1/16HP 125, 250V AC 3A 30V DC | LR26550 etc. | 7A 250V AC 1/16HP 125, 250V AC 3A 30V DC | — | — | — | — | |
| | 4 Form C | E43028 5A 250V AC 1/10HP 125, 250V AC 3A 30V DC | LR26550 etc. | 5A 250V AC 1/10HP 125, 250V AC 3A 30V DC | 40017406 | 5A 65V AC (cosφ=1.0) 3A 65V AC (cosφ=0.4) 3A 30V DC (0ms) | — | — | |
| | 4 Form C twin | E43149 3A 250V AC 3A 30V DC | LR26550 etc. | 3A 250V AC 3A 30V DC | — | — | — | — | |
| HC Amber | 1 Form C | E43028 6A 250V AC 1/8HP 125, 250V AC 3A 30V DC | LR26550 etc. | 6A 250V AC 1/8HP 125, 250V AC 3A 30V DC | — | — | — | — | |
| | 2 Form C | E43028 4A 250V AC 1/10HP 125, 250V AC 3A 30V DC | LR26550 etc. | 4A 250V AC 1/10HP 125, 250V AC 3A 30V DC | — | — | — | — | |
| | 4 Form C | E43028 2A 250V AC 1/20HP 125, 250V AC 2A 30V DC | LR26550 etc. | 2A 250V AC 1/20HP 125, 250V AC 2A 30V DC | — | — | — | — | |
| | 4 Form C twin | E43149 1A 250V AC 1A 30V DC | LR26550 etc. | 1A 250V AC 1A 30V DC | — | — | — | — | |
| HC keep | E43149 3A 250V AC 3A 30V DC | LR26550 etc. | 3A 250V AC 3A 30V DC | — | — | — | — | Approved (DC type only) | |

HC

| Item | UL/C-UL (Recognized) | | CSA (Certified) | | VDE (Certified) | | TV rating (UL/CSA) | | Remarks |
|-----------------------------|----------------------|--|-----------------|--|-----------------|----------------|--------------------|--------|---------|
| | File No. | Contact rating | File No. | Contact rating | File No. | Contact rating | File No. | Rating | |
| HC with diode type (For DC) | 1 Form C | E43028 10A 250V AC 1/8HP 125, 250V AC 3A 30V DC | LR26550 etc. | 10A 250V AC 1/8HP 125, 250V AC 3A 30V DC | — | — | — | — | |
| | 2 Form C | E43028 7A 250V AC 1/8HP 125, 250V AC 3A 30V DC | LR26550 etc. | 7A 250V AC 1/8HP 125, 250V AC 3A 30V DC | — | — | — | — | |
| | 3 Form C | E43028 7A 250V AC 1/8HP 125, 250V AC 3A 30V DC | LR26550 etc. | 7A 250V AC 1/8HP 125, 250V AC 3A 30V DC | — | — | — | — | |
| | 4 Form C | E43028 5A 250V AC 1/10HP 125, 250V AC 3A 30V DC | LR26550 etc. | 5A 250V AC 1/10HP 125, 250V AC 3A 30V DC | — | — | — | — | |
| | 4 Form C twin | E43149 3A 250V AC 3A 30V DC | LR26550 etc. | 3A 250V AC 3A 30V DC | — | — | — | — | |
| HC with CR circuit | 1 Form C | E43028 10A 250V AC 1/8HP 125, 250V AC 3A 30V DC | LR26550 etc. | 10A 250V AC 1/8HP 125, 250V AC 3A 30V DC | — | — | — | — | |
| | 2 Form C | E43028 7A 250V AC 1/8HP 125, 250V AC 3A 30V DC | LR26550 etc. | 7A 250V AC 1/8HP 125, 250V AC 3A 30V DC | — | — | — | — | |
| | 3 Form C | E43028 7A 250V AC 1/8HP 125, 250V AC 3A 30V DC | LR26550 etc. | 7A 250V AC 1/8HP 125, 250V AC 3A 30V DC | — | — | — | — | |
| | 4 Form C | E43028 5A 250V AC 1/10HP 125, 250V AC 3A 30V DC | LR26550 etc. | 5A 250V AC 1/10HP 125, 250V AC 3A 30V DC | — | — | — | — | |
| | 4 Form C twin | E43149 3A 250V AC 3A 30V DC | LR26550 etc. | 3A 250V AC 3A 30V DC | — | — | — | — | |

NOTES

1. Amber sealed type

When mounting TM types, use washers to prevent damage or distortion to the polycarbonate cover. When tightening fixing screws, the optimum torque range should be 0.294 to 0.49 N·m, (3 to 5 kgf·cm). If screws are over tightened, the cover may distort, resulting in poor sealing. Moreover, to prevent loosening, use washers.

2. Keep relay

- 1) The schematic differs from that in the standard type 4 Form C HC relay. Follow the schematic on the cover sticker.
- 2) Conform with the schematic for the DC type, which has a polarized coil.

3) Because retention characteristics vary according to the waveform of the voltage applied to the coil, do your best to avoid capacitor driving.

In capacitor driving, use a capacitor of 300 μF or more.

4) Ensure that the minimum pulse width of voltage applied to coil is greater than 150 ms.

3. Diode characteristics

- 1) Reverse breakdown voltage: 1,000 V
- 2) Forward current: 1 A

4. Diode and CR built-in type

Since the diode and CR inside the relay coil are designed to absorb the counter emf, the element may be damaged if a

large surge, etc., is applied to the diode and CR.

If there is the possibility of a large surge voltage from the outside, please implement measures to absorb it.

5. Please connect DC coil types with LED and built-in diode correctly by verifying the coil polarity (“+” and “-”). Connecting with reverse polarity will cause the LED not to light and damage the built-in diode due to its specification.

For Cautions for Use.

FEATURES

1. HC Relay Sockets

In the table below, the socket suitable for each type of HC relay is indicated by a black dot.

- 1) Plug-in type sockets, PC board type sockets, and wrapping type sockets are available for HC relays.
- 2) Certified by UL and CSA
- 3) A hold-down clip is included in the package.



The fixing method is the same as for HC sockets, ordinary HC terminal sockets and HL sockets.

HC/HL-LEAF-SPRING-MK

Note: Not compatible with HJ relays.
Please use the HJ relay dedicated socket.

2. HC Relay Terminal sockets

In the table below, the terminal socket suitable for each type of HC relay is indicated by a black dot.

- 1) Ordinary terminal sockets and terminal sockets for DIN rail assembly are available.
- 2) Certified by UL/C-UL
- 3) A hold-down clip is included in the package.



The fixing method is the same as for sockets.

Ordinary terminal socket
HC/HL-LEAF-SPRING-MK



The fixing method is the same as for the HC DIN rail terminal sockets and the HL DIN rail terminal sockets.

DIN rail Terminal sockets
HC/HL-LEAF-SPRING-K

Note: Not compatible with HJ relays.
Please use the HJ relay dedicated terminal socket.

SELECTOR CHART

1. Sockets

| Type | No. of pole | Product name | Part No. | Applicable HC relay (Plug-in type) | | | | | | | | | | | |
|----------|---------------------|------------------------------|----------|--|----------|----------|----------|-----------------|------------|----------|----------|-----------------|------------|----------|---|
| | | | | Standard type/With diode type (for DC) | | | | | Amber type | | | | Keep relay | | |
| | | | | 1 Form C | 2 Form C | 3 Form C | 4 Form C | 4 Form C (twin) | 1 Form C | 2 Form C | 4 Form C | 4 Form C (twin) | | 2 Form C | |
| Plug-in | 1-pole | HC1-socket | HC1-SS-K | ● | | | | | | ● | | | | | |
| | 2-pole | HC2-socket | HC2-SS-K | | ● | | | | | | ● | | | | |
| | 3-pole | HC3-socket | HC3-SS-K | | ● | ● | | | | | ● | | | | |
| | 1/2/4-pole (common) | HC4-socket | HC4-SS-K | ● | ● | | ● | ● | ● | ● | ● | ● | ● | ● | ● |
| PC board | 1-pole | HC1-socket for PC board | HC1-PS-K | ● | | | | | | ● | | | | | |
| | 2-pole | HC2-socket for PC board | HC2-PS-K | | ● | | | | | | ● | | | | |
| | 3-pole | HC3-socket for PC board | HC3-PS-K | | ● | ● | | | | | ● | | | | |
| | 1/2/4-pole (common) | HC4-socket for PC board | HC4-PS-K | ● | ● | | ● | ● | ● | ● | ● | ● | ● | ● | ● |
| Wrapping | 1/2/4-pole (common) | HC4-wrapping socket | HC4-WS-K | ● | ● | | ● | ● | ● | ● | ● | ● | ● | ● | ● |
| | | HC4-wrapping socket (spring) | HC4-WS | ● | ● | | ● | ● | ● | ● | ● | ● | ● | ● | ● |

Standard packing: Carton: 20 pcs.; Case: 200 pcs.

- Notes: 1. Use the hold-down clip that is shipped with the socket. (The hold-down clip for HC relay with CR circuit is included in the package).
2. Certified by UL and CSA (except for wrapping socket).
3. Not compatible with HJ relays.

2. Terminal sockets

| Type | No. of pole | Item | Part No. | Standard packing | | Applicable HC relay (Plug-in type) | | | | | | | | | |
|--------------|---------------------|-----------------------------------|-----------|------------------|----------|--|----------|----------|----------|-----------------|------------|----------|----------|-----------------|------------|
| | | | | | | Standard type/With diode type (for DC) | | | | | Amber type | | | | Keep relay |
| | | | | Carton | Case | 1 Form C | 2 Form C | 3 Form C | 4 Form C | 4 Form C (twin) | 1 Form C | 2 Form C | 4 Form C | 4 Form C (twin) | |
| For DIN rail | 2-pole | HC2-slim type DIN terminal socket | HC2-SFD-S | 20 pcs. | 100 pcs. | | ● | | | | | | ● | | |
| | 2-pole | HC2-DIN | HC2-SFD-K | 10 pcs. | 100 pcs. | | ● | | | | | | ● | | |
| | 3-pole | HC3-DIN | HC3-SFD-K | 5 pcs. | 50 pcs. | | ● | ● | | | | | ● | | |
| | 1/2/4-pole (common) | HC4-DIN high terminal socket | HC4-SFD-K | 10 pcs. | 100 pcs. | ● | ● | | ● | ● | ● | ● | ● | ● | ● |
| | 1/2/4-pole (common) | HC vertical terminal socket | HC4-TSF-K | 20 pcs. | 200 pcs. | ● | ● | | ● | ● | ● | ● | ● | ● | ● |
| For general | 2-pole | HC2-terminal socket | HC2-SF-K | 10 pcs. | 100 pcs. | | ● | | | | | | ● | | |
| | 3-pole | HC3-high terminal socket | HC3-HSF-K | 5 pcs. | 50 pcs. | | ● | ● | | | | | ● | | |
| | 1/2/4-pole (common) | HC-high terminal socket | HC4-HSF-K | 5 pcs. | 50 pcs. | ● | ● | | ● | ● | ● | ● | ● | ● | ● |

Notes: 1. Use the hold-down clip that is shipped with the socket. (The hold-down clip for HC relay with CR circuit is included in the package).

2. Certified by UL/C-UL (except for HC4-TSF-K).
3. In order to prevent breakage and disfiguring, the screw tightening torque for the terminal socket should be within the range of 0.49 to 0.69 N·m {5 to 7kgf·cm}.
4. Not compatible with HJ relays.

HC RELAY ACCESSORIES

DIMENSIONS (mm inch)

The CAD data of the products with a **CAD Data** mark can be downloaded from: <http://panasonic-electric-works.net/ac>

1. Plug-in type sockets

CAD Data



External dimensions

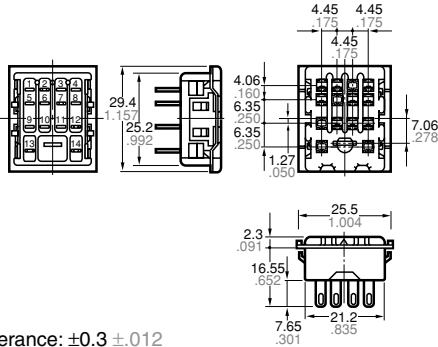

General tolerance: $\pm 0.3 \pm 0.012$

HC2-Socket (HC2-SS-K)

CAD Data



External dimensions

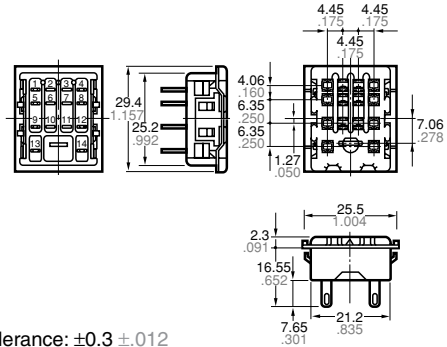

General tolerance: $\pm 0.3 \pm 0.012$

HC3-Socket (HC3-SS-K)

CAD Data



External dimensions

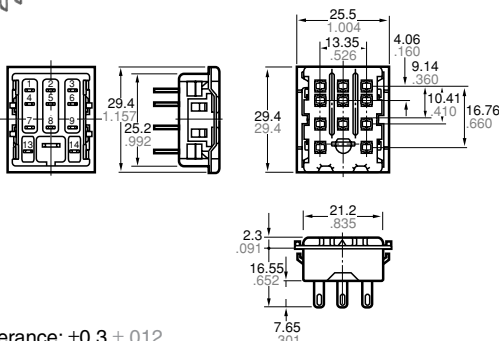

General tolerance: $\pm 0.3 \pm 0.012$

HC4-Socket (HC4-SS-K)

CAD Data

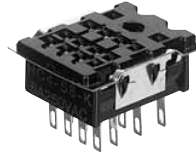

External dimensions

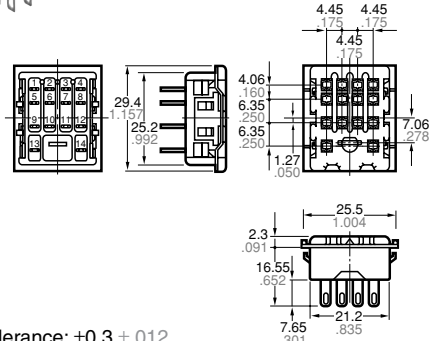

General tolerance: $\pm 0.3 \pm 0.012$

Mounting hole diagram

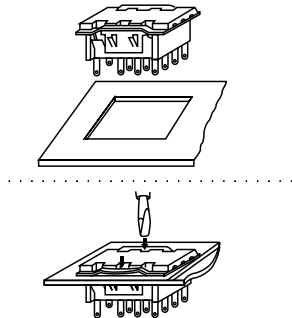

Side-by-side installation

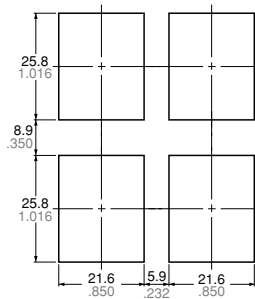

General tolerance: $\pm 0.2 \pm 0.008$

With a relay mounted (HC2-SS-K)



Hold-down clip is packaged with the socket.

- Notes: 1. Applicable chassis board thickness is 1.0 to 2.0 mm.
2. Installation is easy by inserting the socket from the top into the holes and by depressing the two down arrows on the retention fitting from the front.

HC RELAY ACCESSORIES

2. PC board type sockets

HC1- PC board type socket (HC1-PS-K)

CAD Data



External dimensions

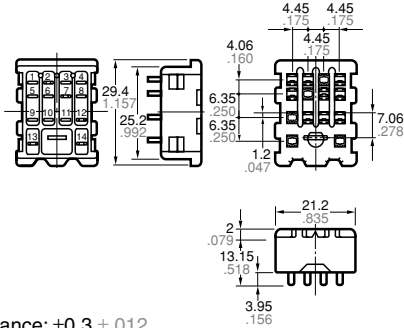

General tolerance: $\pm 0.3 \pm 0.12$

HC2- PC board type socket (HC2-PS-K)

CAD Data



External dimensions

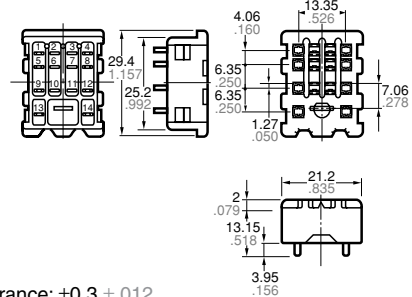

General tolerance: $\pm 0.3 \pm 0.12$

HC3- PC board type socket (HC3-PS-K)

CAD Data



External dimensions

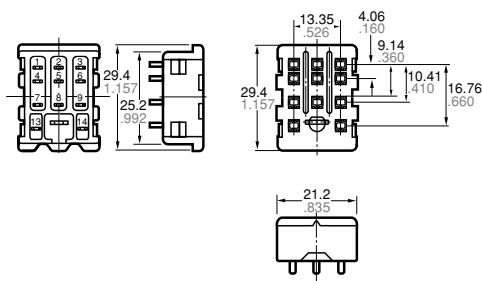

General tolerance: $\pm 0.3 \pm 0.12$

HC4- PC board type socket (HC4-PS-K)

CAD Data



External dimensions

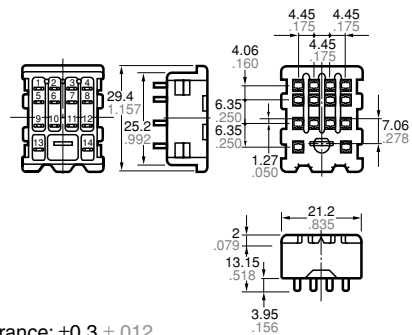

General tolerance: $\pm 0.3 \pm 0.12$

PC board pattern (Bottom view)

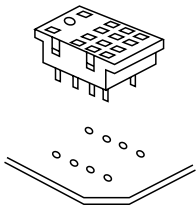

With a relay mounted



Side-by-side installation

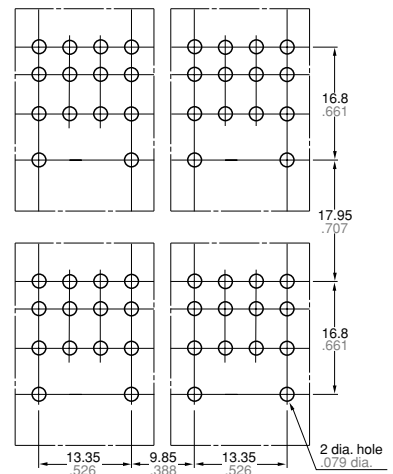

Hold-down clip is packaged with the socket.

1 Form C

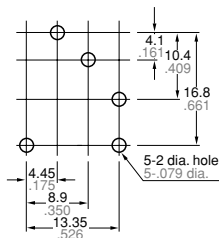

2 Form C

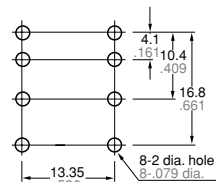

3 Form C

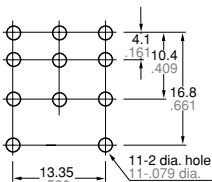

4 Form C

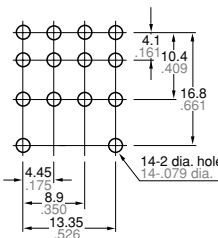

General tolerance: $\pm 0.1 \pm 0.04$

HC RELAY ACCESSORIES

3. Wrapping type sockets

Standard wrapping type sockets
(HC4-WS-K)

CAD Data

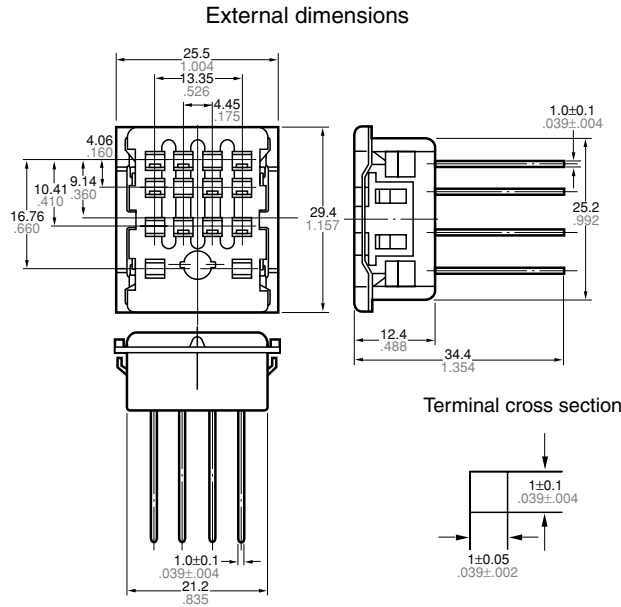
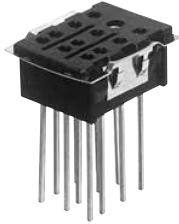

Hold-down clip
(Hold-down clip is packaged with the socket)



General tolerance: $\pm 0.3 \pm 0.012$

Note: The external and mounting dimensions are the same for 1-pole (HC1-WS-K), 2-pole (HC2-WS-K), and 3-pole (HC3-WS-K) types. Only the number of terminals varies.

Wrapping type sockets with hold-down clip
(HC4-WS)

CAD Data

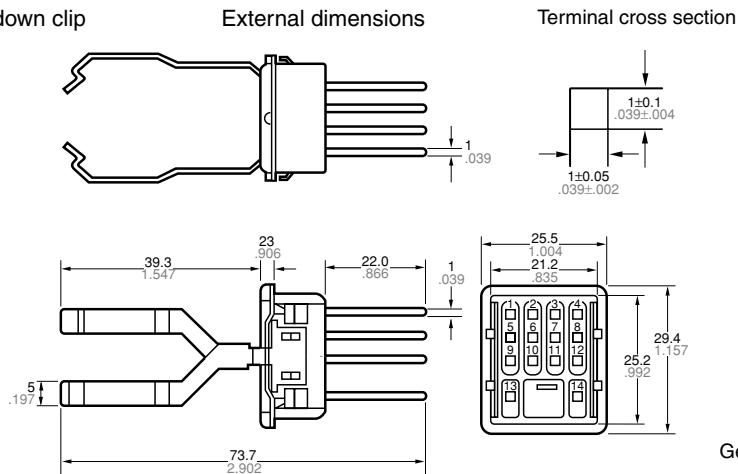
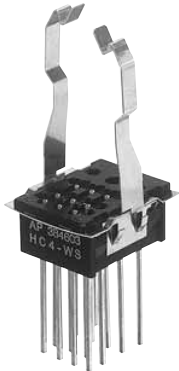

General tolerance: $\pm 0.7 \pm 0.028$

Mounting hole diagram

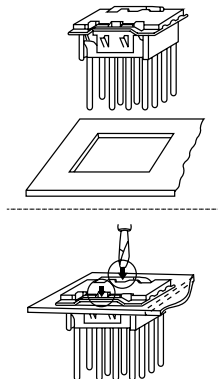

Side-by-side installation

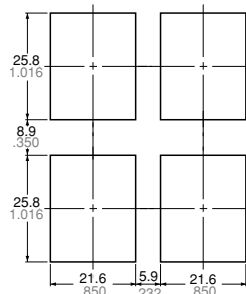

General tolerance: $\pm 0.2 \pm 0.008$

- Notes:
1. Applicable chassis board thickness is 1.0 to 2.0 mm.
 2. Installation is easy by inserting the socket from the top into the holes and by depressing the two down arrows on the retention fitting from the front.

HC RELAY ACCESSORIES

4. DIN rail Terminal sockets

HC2-Slim type DIN rail terminal sockets (HC2-SFD-S)

CAD Data

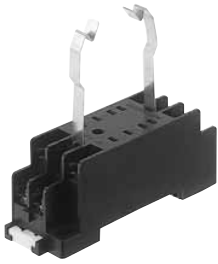

External dimensions

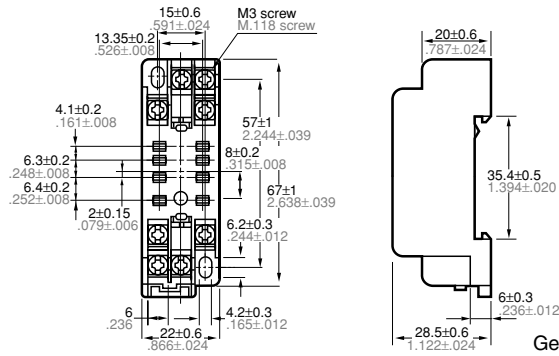

Schematic

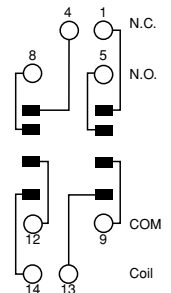

General tolerance: $\pm 0.5 \pm .020$

HC2-high DIN rail terminal socket (HC2-SFD-K)

CAD Data

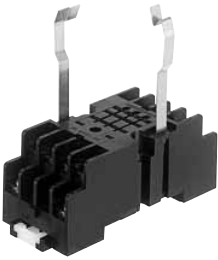

External dimensions

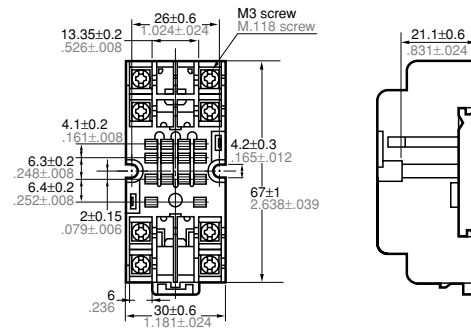

Schematic

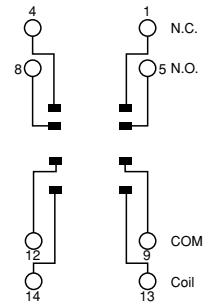

General tolerance: $\pm 0.5 \pm .020$

HC3-high DIN rail terminal socket (HC3-SFD-K)

CAD Data

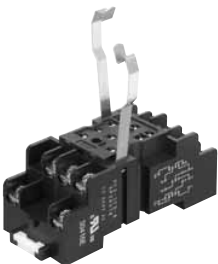

External dimensions

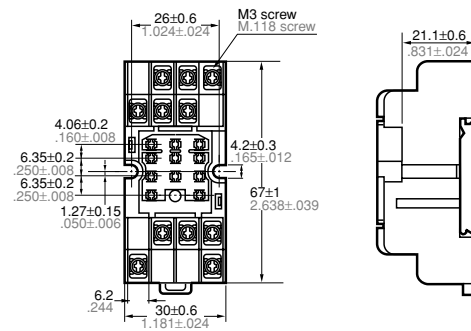

Schematic

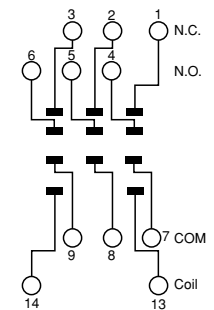

General tolerance: $\pm 0.5 \pm .020$

HC4-high DIN rail terminal socket (HC4-SFD-K)

CAD Data

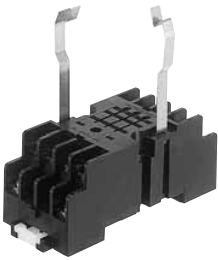

External dimensions

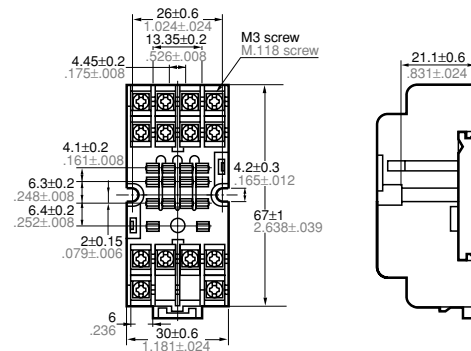

Schematic

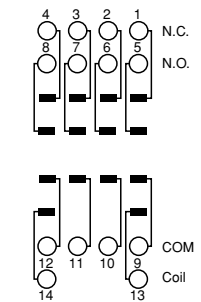

General tolerance: $\pm 0.5 \pm .020$

HC RELAY ACCESSORIES

HC vertical type terminal socket (HC4-TSF-K)

CAD Data

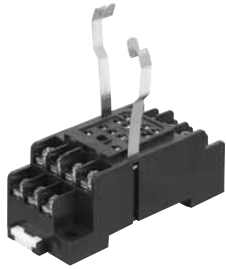

External dimensions

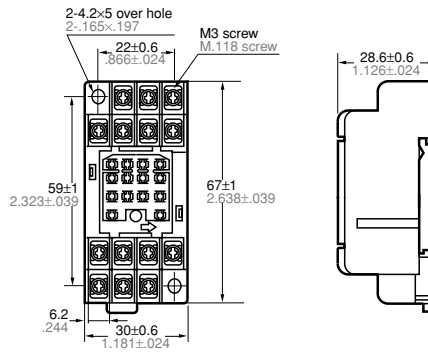

Schematic

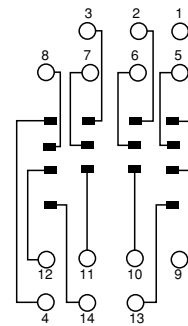

General tolerance: $\pm 0.5 \pm 0.20$

Mounting hole diagram HC2-Slim type

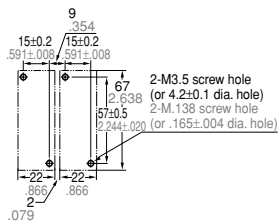

HC2, HC3 and HC4

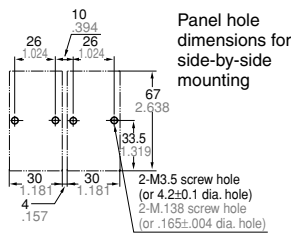

HC vertical type

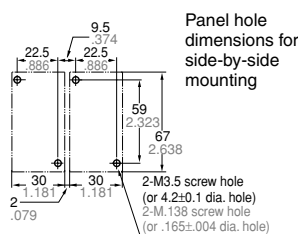

With a relay mounted (HC4-SFD-K)



General tolerance: $\pm 0.1 \pm 0.004$

Hold-down clip is packaged with the terminal socket.

5. Ordinary terminal sockets

HC2-terminal socket (HC2-SF-K for HC2)

CAD Data



External dimensions

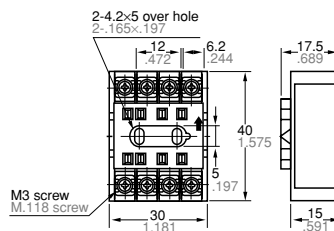

Schematic

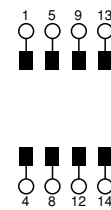

General tolerance: $\pm 0.5 \pm 0.20$

HC3-high terminal socket (HC3-HSF-K) suitable for both HC2 and HC3

CAD Data



External dimensions

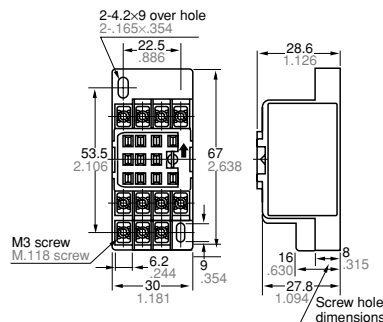

Schematic

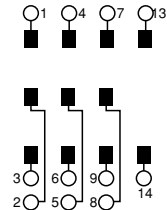

General tolerance: $\pm 0.5 \pm 0.20$

HC RELAY ACCESSORIES

HC4-high terminal socket (HC4-HSF-K) suitable for HC 1, 2 and 4

CAD Data



External dimensions

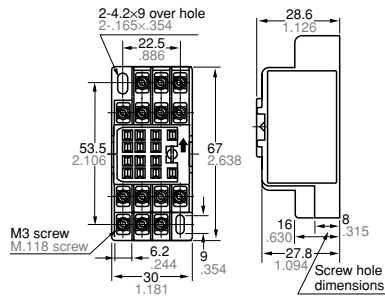

Schematic

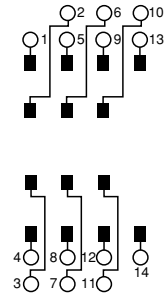

General tolerance: $\pm 0.5 \pm 0.020$

**Mounting hole diagram
HC2-SF-K**

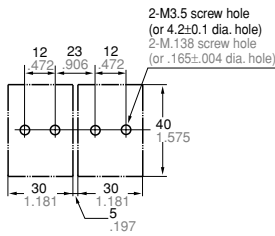

Panel hole dimensions for side-by-side mounting

HC3-HSF-K and HC4-HSF-K

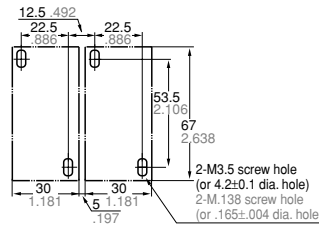

Panel hole dimensions for side-by-side mounting

General tolerance: $\pm 0.1 \pm 0.004$

With a relay mounted (HC2-SF-K)



Hold-down clip is packaged with the terminal socket.