

FEATURES

- SNR = 69.7 dBFS at 185 MHz A_{IN} and 250 MSPS
- SFDR = 87 dBc at 185 MHz A_{IN} and 250 MSPS
- 150.6 dBFS/Hz input noise at 185 MHz, -1 dBFS A_{IN} and 250 MSPS
- Total power consumption: 360 mW at 250 MSPS
- 1.8 V supply voltages
- LVDS (ANSI-644 levels) outputs
- Integer 1-to-8 input clock divider (625 MHz maximum input)
- Sample rates of up to 250 MSPS
- IF sampling frequencies of up to 350 MHz
- Internal ADC voltage reference
- Flexible analog input range
 - 1.4 V p-p to 2.0 V p-p (1.75 V p-p nominal)
- ADC clock duty cycle stabilizer
- Serial port control
- Energy-saving power-down modes
- User-configurable, built-in self test (BIST) capability

APPLICATIONS

- Communications
- Diversity radio systems
- Multimode digital receivers (3G)
 - TD-SCDMA, WiMAX, W-CDMA, CDMA2000, GSM, EDGE, LTE
- I/Q demodulation systems
- Smart antenna systems
- General-purpose software radios
- Ultrasound equipment
- Broadband data applications

GENERAL DESCRIPTION

The AD9634 is a 12-bit, analog-to-digital converter (ADC) with sampling speeds of up to 250 MSPS. The AD9634 is designed to support communications applications where low cost, small size, wide bandwidth, and versatility are desired.

The ADC core features a multistage, differential pipelined architecture with integrated output error correction logic. The ADC features wide bandwidth inputs that can support a variety of user-selectable input ranges. An integrated voltage reference eases design considerations. A duty cycle stabilizer (DCS) is provided to compensate for variations in the ADC clock duty cycle, allowing the converter to maintain excellent performance.

The ADC output data are routed directly to the external 12-bit LVDS output port.

Flexible power-down options allow significant power savings, when desired.

Rev. 0

Information furnished by Analog Devices is believed to be accurate and reliable. However, no responsibility is assumed by Analog Devices for its use, nor for any infringements of patents or other rights of third parties that may result from its use. Specifications subject to change without notice. No license is granted by implication or otherwise under any patent or patent rights of Analog Devices. Trademarks and registered trademarks are the property of their respective owners.

FUNCTIONAL BLOCK DIAGRAM

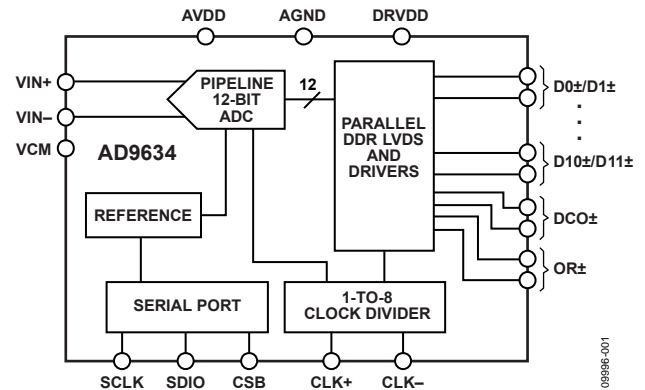

Figure 1.

00996-001

Programming for setup and control is accomplished using a 3-wire, SPI-compatible serial interface.

The AD9634 is available in a 32-lead LFCSP and is specified over the industrial temperature range of -40°C to +85°C. This product is protected by a U.S. patent.

PRODUCT HIGHLIGHTS

1. Integrated 12-bit, 170 MSPS/210 MSPS/250 MSPS ADC.
2. Fast overrange and threshold detect.
3. Proprietary differential input maintains excellent SNR performance for input frequencies of up to 350 MHz.
4. 3-pin, 1.8 V SPI port for register programming and readback.
5. Pin compatibility with the AD9642, allowing a simple migration up to 14 bits, and with the AD6672.

TABLE OF CONTENTS

| | | | |
|--|----|--|----|
| Features | 1 | ADC Architecture | 19 |
| Applications..... | 1 | Analog Input Considerations | 19 |
| Functional Block Diagram | 1 | Voltage Reference | 21 |
| General Description | 1 | Clock Input Considerations..... | 21 |
| Product Highlights | 1 | Power Dissipation and Standby Mode | 23 |
| Revision History | 2 | Digital Outputs | 23 |
| Specifications..... | 3 | ADC Overrange (OR)..... | 23 |
| ADC DC Specifications..... | 3 | Serial Port Interface (SPI)..... | 24 |
| ADC AC Specifications | 4 | Configuration Using the SPI..... | 24 |
| Digital Specifications | 6 | Hardware Interface..... | 24 |
| Switching Specifications | 7 | SPI Accessible Features..... | 25 |
| Timing Specifications | 8 | Memory Map | 26 |
| Absolute Maximum Ratings..... | 9 | Reading the Memory Map Register Table..... | 26 |
| Thermal Characteristics | 9 | Memory Map Register Table..... | 27 |
| ESD Caution..... | 9 | Applications Information | 29 |
| Pin Configuration and Function Descriptions..... | 10 | Design Guidelines | 29 |
| Typical Performance Characteristics | 12 | Outline Dimensions | 30 |
| Equivalent Circuits | 18 | Ordering Guide | 30 |
| Theory of Operation | 19 | | |

REVISION HISTORY

7/11—Revision 0: Initial Version

SPECIFICATIONS

ADC DC SPECIFICATIONS

AVDD = 1.8 V, DRVDD = 1.8 V, maximum sample rate, VIN = -1.0 dBFS differential input, 1.75 V p-p full scale input range, DCS enabled, unless otherwise noted.

Table 1.

| Parameter | Temperature | AD9634-170 | | | AD9634-210 | | | AD9634-250 | | | Unit |
|--|-------------|------------|-----|-----|------------|-----|-----|------------|-----|-----|---------|
| | | Min | Typ | Max | Min | Typ | Max | Min | Typ | Max | |
| RESOLUTION | Full | 12 | | | 12 | | | 12 | | | Bits |
| ACCURACY | | Guaranteed | | | Guaranteed | | | Guaranteed | | | |
| No Missing Codes | Full | Guaranteed | | | Guaranteed | | | Guaranteed | | | |
| Offset Error | Full | ±11 | | | ±11 | | | ±11 | | | mV |
| Gain Error | Full | +2/-11 | | | +1/-8 | | | +3/-7 | | | %FSR |
| Differential Nonlinearity (DNL) | Full | ±0.4 | | | ±0.4 | | | ±0.4 | | | LSB |
| | 25°C | ±0.22 | | | ±0.22 | | | ±0.22 | | | LSB |
| Integral Nonlinearity (INL) ¹ | Full | ±0.4 | | | ±0.4 | | | ±0.6 | | | LSB |
| | 25°C | ±0.2 | | | ±0.2 | | | ±0.27 | | | LSB |
| TEMPERATURE DRIFT | | | | | | | | | | | |
| Offset Error | Full | ±7 | | | ±7 | | | ±7 | | | ppm/°C |
| Gain Error | Full | ±55 | | | ±58 | | | ±75 | | | ppm/°C |
| INPUT REFERRED NOISE | | | | | | | | | | | |
| VREF = 1.0 V | 25°C | 0.531 | | | 0.391 | | | 0.407 | | | LSB rms |
| ANALOG INPUT | | | | | | | | | | | |
| Input Span | Full | 1.75 | | | 1.75 | | | 1.75 | | | V p-p |
| Input Capacitance ² | Full | 2.5 | | | 2.5 | | | 2.5 | | | pF |
| Input Resistance ³ | Full | 20 | | | 20 | | | 20 | | | kΩ |
| Input Common-Mode Voltage | Full | 0.9 | | | 0.9 | | | 0.9 | | | V |
| POWER SUPPLIES | | | | | | | | | | | |
| Supply Voltage | | | | | | | | | | | |
| AVDD | Full | 1.7 | 1.8 | 1.9 | 1.7 | 1.8 | 1.9 | 1.7 | 1.8 | 1.9 | V |
| DRVDD | Full | 1.7 | 1.8 | 1.9 | 1.7 | 1.8 | 1.9 | 1.7 | 1.8 | 1.9 | V |
| Supply Current | | | | | | | | | | | |
| I _{AVDD} ¹ | Full | 123 | | 134 | 129 | | 139 | 136 | | 145 | mA |
| I _{DRVDD} ¹ | Full | 50 | | 54 | 56 | | 60 | 64 | | 68 | mA |
| POWER CONSUMPTION | | | | | | | | | | | |
| Sine Wave Input (DRVDD = 1.8 V) | Full | 311 | | 340 | 333 | | 360 | 360 | | 385 | mW |
| Standby Power ⁴ | Full | 50 | | | 50 | | | 50 | | | mW |
| Power-Down Power | Full | 5 | | | 5 | | | 5 | | | mW |

¹ Measured with a low input frequency, full-scale sine wave.

² Input capacitance refers to the effective capacitance between one differential input pin and its complement.

³ Input resistance refers to the effective resistance between one differential input pin and its complement.

⁴ Standby power is measured with a dc input and the CLK pin inactive (that is, set to AVDD or AGND).

AD9634

ADC AC SPECIFICATIONS

AVDD = 1.8 V, DRVDD = 1.8 V, maximum sample rate, VIN = -1.0 dBFS differential input, 1.75 V p-p full-scale input range, unless otherwise noted.

Table 2.

| Parameter ¹ | Temperature | AD9634-170 | | | AD9634-210 | | | AD9634-250 | | | Unit |
|--|-------------|------------|------|-----|------------|------|-----|------------|------|-----|------|
| | | Min | Typ | Max | Min | Typ | Max | Min | Typ | Max | |
| SIGNAL-TO-NOISE RATIO (SNR) | | | | | | | | | | | |
| f _{IN} = 30 MHz | 25°C | | 70.3 | | | 70.2 | | | 70.1 | | dBFS |
| f _{IN} = 90 MHz | 25°C | | 70.1 | | | 70.1 | | | 70.0 | | dBFS |
| | Full | 69.1 | | | 68.8 | | | | | | dBFS |
| f _{IN} = 140 MHz | 25°C | | 69.9 | | | 70.0 | | | 69.9 | | dBFS |
| f _{IN} = 185 MHz | 25°C | | 69.5 | | | 69.6 | | | 69.7 | | dBFS |
| | Full | | | | | | | 67.8 | | | dBFS |
| f _{IN} = 220 MHz | 25°C | | 69.2 | | | 69.2 | | | 69.3 | | dBFS |
| SIGNAL-TO-NOISE AND DISTORTION (SINAD) | | | | | | | | | | | |
| f _{IN} = 30 MHz | 25°C | | 69.4 | | | 69.2 | | | 69.2 | | dBFS |
| f _{IN} = 90 MHz | 25°C | | 69.2 | | | 69.1 | | | 69.0 | | dBFS |
| | Full | 68.1 | | | 67.8 | | | | | | dBFS |
| f _{IN} = 140 MHz | 25°C | | 68.9 | | | 69.1 | | | 69.0 | | dBFS |
| f _{IN} = 185 MHz | 25°C | | 68.5 | | | 68.7 | | | 68.7 | | dBFS |
| | Full | | | | | | | 66.7 | | | dBFS |
| f _{IN} = 220 MHz | 25°C | | 68.3 | | | 68.3 | | | 68.4 | | dBFS |
| EFFECTIVE NUMBER OF BITS (ENOB) | | | | | | | | | | | |
| f _{IN} = 30 MHz | 25°C | | 11.2 | | | 11.2 | | | 11.2 | | Bits |
| f _{IN} = 90 MHz | 25°C | | 11.2 | | | 11.2 | | | 11.2 | | Bits |
| f _{IN} = 140 MHz | 25°C | | 11.1 | | | 11.2 | | | 11.2 | | Bits |
| f _{IN} = 185 MHz | 25°C | | 11.1 | | | 11.1 | | | 11.1 | | Bits |
| f _{IN} = 220 MHz | 25°C | | 11.0 | | | 11.0 | | | 11.1 | | Bits |
| WORST SECOND OR THIRD HARMONIC | | | | | | | | | | | |
| f _{IN} = 30 MHz | 25°C | | -96 | | | -96 | | | -90 | | dBc |
| f _{IN} = 90 MHz | 25°C | | -95 | | | -92 | | | -89 | | dBc |
| | Full | | | -83 | | | -80 | | | | dBc |
| f _{IN} = 140 MHz | 25°C | | -97 | | | -94 | | | -91 | | dBc |
| f _{IN} = 185 MHz | 25°C | | -86 | | | -95 | | | -87 | | dBc |
| | Full | | | | | | | | -80 | | dBc |
| f _{IN} = 220 MHz | 25°C | | -84 | | | -84 | | | -93 | | dBc |
| SPURIOUS-FREE DYNAMIC RANGE (SFDR) | | | | | | | | | | | |
| f _{IN} = 30 MHz | 25°C | | 96 | | | 96 | | | 90 | | dBc |
| f _{IN} = 90 MHz | 25°C | | 95 | | | 92 | | | 89 | | dBc |
| | Full | 83 | | | 80 | | | | | | dBc |
| f _{IN} = 140 MHz | 25°C | | 97 | | | 94 | | | 91 | | dBc |
| f _{IN} = 185 MHz | 25°C | | 86 | | | 95 | | | 87 | | dBc |
| | Full | | | | | | | 80 | | | dBc |
| f _{IN} = 220 MHz | 25°C | | 84 | | | 84 | | | 93 | | dBc |
| WORST OTHER (HARMONIC OR SPUR) | | | | | | | | | | | |
| f _{IN} = 30 MHz | 25°C | | -98 | | | -96 | | | -95 | | dBc |
| f _{IN} = 90 MHz | 25°C | | -97 | | | -95 | | | -95 | | dBc |
| | Full | | | -87 | | | -83 | | | | dBc |
| f _{IN} = 140 MHz | 25°C | | -98 | | | -97 | | | -96 | | dBc |
| f _{IN} = 185 MHz | 25°C | | -95 | | | -95 | | | -94 | | dBc |
| | Full | | | | | | | | -81 | | dBc |
| f _{IN} = 220 MHz | 25°C | | -96 | | | -95 | | | -94 | | dBc |

| Parameter ¹ | Temperature | AD9634-170 | | | AD9634-210 | | | AD9634-250 | | | Unit |
|--|-------------|------------|------|-----|------------|------|-----|------------|------|-----|------|
| | | Min | Typ | Max | Min | Typ | Max | Min | Typ | Max | |
| TWO-TONE SFDR $f_{IN} = 184.1 \text{ MHz}, 187.1 \text{ MHz} (-7 \text{ dBFS})$ | 25°C | | 87 | | | 89 | | | 88 | | dBc |
| FULL POWER BANDWIDTH ² | 25°C | | 350 | | | 350 | | | 350 | | MHz |
| NOISE BANDWIDTH ³ | 25°C | | 1000 | | | 1000 | | | 1000 | | MHz |

¹ See the [AN-835 Application Note](#), *Understanding High Speed ADC Testing and Evaluation*, for a complete set of definitions.

² Full power bandwidth is the bandwidth of operation where typical ADC performance can be achieved.

³ Noise bandwidth is the -3 dB bandwidth for the ADC inputs across which noise may enter the ADC and is not attenuated internally.

AD9634

DIGITAL SPECIFICATIONS

AVDD = 1.8 V, DRVDD = 1.8 V, maximum sample rate, VIN = -1.0 dBFS differential input, 1.0 V internal reference, DCS enabled, unless otherwise noted.

Table 3.

| Parameter | Temperature | Min | Typ | Max | Unit |
|--|-------------|------------------|------|------|-------|
| DIFFERENTIAL CLOCK INPUTS (CLK+, CLK-) | | | | | |
| Logic Compliance | | CMOS/LVDS/LVPECL | | | |
| Internal Common-Mode Bias | Full | | 0.9 | | V |
| Differential Input Voltage | Full | 0.3 | | 3.6 | V p-p |
| Input Voltage Range | Full | AGND | | AVDD | V |
| Input Common-Mode Range | Full | 0.9 | | 1.4 | V |
| High Level Input Current | Full | 10 | | 22 | μA |
| Low Level Input Current | Full | -22 | | -10 | μA |
| Input Capacitance | Full | | 4 | | pF |
| Input Resistance | Full | 12 | 15 | 18 | kΩ |
| LOGIC INPUT (CSB) ¹ | | | | | |
| High Level Input Voltage | Full | 1.22 | | 2.1 | V |
| Low Level Input Voltage | Full | 0 | | 0.6 | V |
| High Level Input Current | Full | 50 | | 71 | μA |
| Low Level Input Current | Full | -5 | | +5 | μA |
| Input Resistance | Full | | 26 | | kΩ |
| Input Capacitance | Full | | 2 | | pF |
| LOGIC INPUT (SCLK) ² | | | | | |
| High Level Input Voltage | Full | 1.22 | | 2.1 | V |
| Low Level Input Voltage | Full | 0 | | 0.6 | V |
| High Level Input Current | Full | 45 | | 70 | μA |
| Low Level Input Current | Full | -5 | | +5 | μA |
| Input Resistance | Full | | 26 | | kΩ |
| Input Capacitance | Full | | 2 | | pF |
| LOGIC INPUTS (SDIO) ¹ | | | | | |
| High Level Input Voltage | Full | 1.22 | | 2.1 | V |
| Low Level Input Voltage | Full | 0 | | 0.6 | V |
| High Level Input Current | Full | 45 | | 70 | μA |
| Low Level Input Current | Full | -5 | | +5 | μA |
| Input Resistance | Full | | 26 | | kΩ |
| Input Capacitance | Full | | 5 | | pF |
| DIGITAL OUTPUTS | | | | | |
| LVDS Data and OR Outputs (OR+, OR-) | | | | | |
| Differential Output Voltage (V _{OD}), ANSI Mode | Full | 250 | 350 | 450 | mV |
| Output Offset Voltage (V _{OS}), ANSI Mode | Full | 1.15 | 1.25 | 1.35 | V |
| Differential Output Voltage (V _{OD}), Reduced Swing Mode | Full | 150 | 200 | 280 | mV |
| Output Offset Voltage (V _{OS}), Reduced Swing Mode | Full | 1.15 | 1.25 | 1.35 | V |

¹ Pull-up.

² Pull-down.

SWITCHING SPECIFICATIONS

Table 4.

| Parameter | Temperature | AD9634-170 | | | AD9634-210 | | | AD9634-250 | | | Unit |
|--|-------------|------------|-----|------|------------|-----|------|------------|-----|-----|---------|
| | | Min | Typ | Max | Min | Typ | Max | Min | Typ | Max | |
| CLOCK INPUT PARAMETERS ¹ | | | | | | | | | | | |
| Input Clock Rate | Full | | | 625 | | | 625 | | | 625 | MHz |
| Conversion Rate ² | | | | | | | | | | | |
| DCS Enabled | Full | 40 | | 170 | 40 | | 210 | 40 | | 250 | MSPS |
| DCS Disabled | Full | 10 | | 170 | 10 | | 210 | 10 | | 250 | MSPS |
| CLK Period, Divide-by-1 Mode (t_{CLK}) | Full | 5.8 | | | 4.8 | | | 4 | | | ns |
| CLK Pulse Width High (t_{CH}) | | | | | | | | | | | |
| Divide-by-1 Mode, DCS Enabled | Full | 2.61 | 2.9 | 3.19 | 2.16 | 2.4 | 2.64 | 1.8 | 2.0 | 2.2 | ns |
| Divide-by-1 Mode, DCS Disabled | Full | 2.76 | 2.9 | 3.05 | 2.28 | 2.4 | 2.52 | 1.9 | 2.0 | 2.1 | ns |
| Divide-by-2 Mode Through Divide-by-8 Mode | Full | 0.8 | | | 0.8 | | | 0.8 | | | ns |
| Aperture Delay (t_A) | Full | | 1.0 | | | 1.0 | | | 1.0 | | ns |
| Aperture Uncertainty (Jitter, t_j) | Full | | 0.1 | | | 0.1 | | | 0.1 | | ps rms |
| DATA OUTPUT PARAMETERS ¹ | | | | | | | | | | | |
| Data Propagation Delay (t_{PD}) | Full | 4.1 | 4.7 | 5.2 | 4.1 | 4.7 | 5.2 | 4.1 | 4.7 | 5.2 | ns |
| DCO Propagation Delay (t_{DCO}) | Full | 4.7 | 5.3 | 5.8 | 4.7 | 5.3 | 5.8 | 4.7 | 5.3 | 5.8 | ns |
| DCO to Data Skew (t_{SKEW}) | Full | 0.3 | 0.5 | 0.7 | 0.3 | 0.5 | 0.7 | 0.3 | 0.5 | 0.7 | ns |
| Pipeline Delay (Latency) | Full | | 10 | | | 10 | | | 10 | | Cycles |
| Wake-Up Time (from Standby) | Full | | 10 | | | 10 | | | 10 | | μ s |
| Wake-Up Time (from Power-Down) | Full | | 100 | | | 100 | | | 100 | | μ s |
| Out-of-Range Recovery Time | Full | | 3 | | | 3 | | | 3 | | Cycles |

¹ See Figure 2.

² Conversion rate is the clock rate after the divider.

Timing Diagram

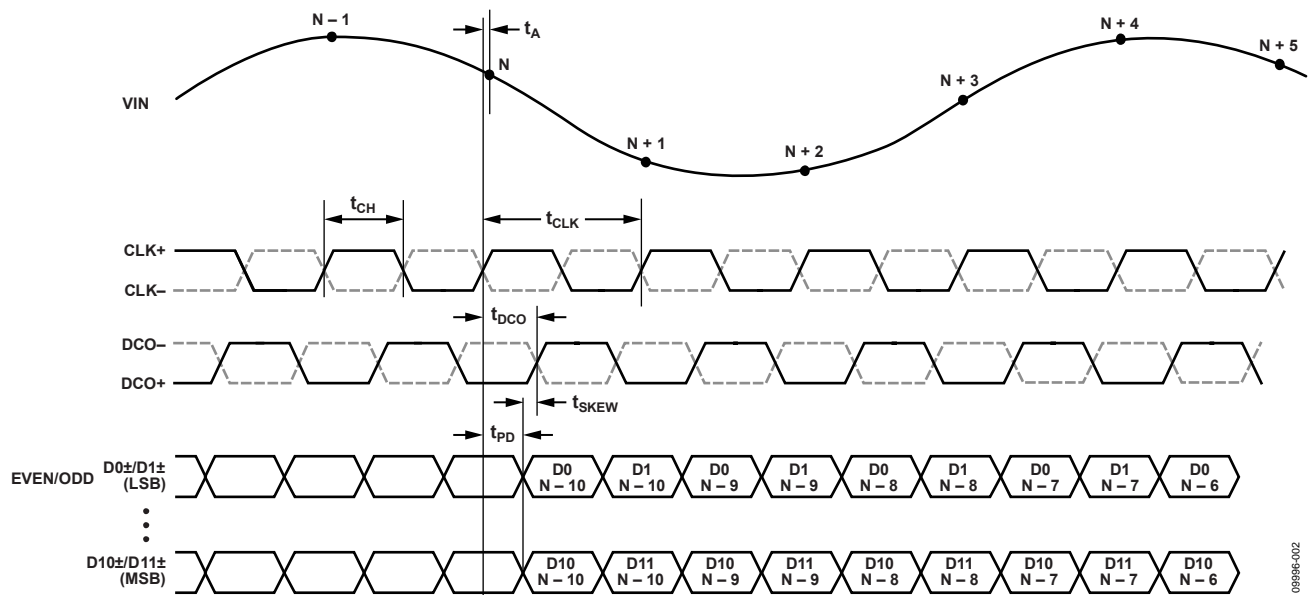

Figure 2. Even/Odd LVDS Mode Data Output Timing

TIMING SPECIFICATIONS

Table 5.

| Parameter | Test Conditions/Comments | Min | Typ | Max | Unit |
|-------------------------|--|-----|-----|-----|------|
| SPI TIMING REQUIREMENTS | See Figure 58 for the SPI timing diagram | | | | |
| t_{DS} | Setup time between the data and the rising edge of SCLK | 2 | | | ns |
| t_{DH} | Hold time between the data and the rising edge of SCLK | 2 | | | ns |
| t_{CLK} | Period of the SCLK | 40 | | | ns |
| t_S | Setup time between CSB and SCLK | 2 | | | ns |
| t_H | Hold time between CSB and SCLK | 2 | | | ns |
| t_{HIGH} | Minimum period that SCLK should be in a logic high state | 10 | | | ns |
| t_{LOW} | Minimum period that SCLK should be in a logic low state | 10 | | | ns |
| t_{EN_SDIO} | Time required for the SDIO pin to switch from an input to an output relative to the SCLK falling edge (not shown in Figure 58) | 10 | | | ns |
| t_{DIS_SDIO} | Time required for the SDIO pin to switch from an output to an input relative to the SCLK rising edge (not shown in Figure 58) | 10 | | | ns |

ABSOLUTE MAXIMUM RATINGS

Table 6.

| Parameter | Rating |
|---|-------------------------|
| Electrical | |
| AVDD to AGND | −0.3 V to +2.0 V |
| DRVDD to AGND | −0.3 V to +2.0 V |
| VIN+, VIN− to AGND | −0.3 V to AVDD + 0.2 V |
| CLK+, CLK− to AGND | −0.3 V to AVDD + 0.2V |
| VCM to AGND | −0.3 V to AVDD + 0.2 V |
| CSB to AGND | −0.3 V to DRVDD + 0.3 V |
| SCLK to AGND | −0.3 V to DRVDD + 0.3 V |
| SDIO to AGND | −0.3 V to DRVDD + 0.3 V |
| D0±/D1± through D10±/D11± to AGND | −0.3 V to DRVDD + 0.3 V |
| DCO+/DCO− to AGND | −0.3 V to DRVDD + 0.3 V |
| OR+/OR− to AGND | −0.3 V to DRVDD + 0.3 V |
| Environmental | |
| Operating Temperature Range (Ambient) | −40°C to +85°C |
| Maximum Junction Temperature Under Bias | 150°C |
| Storage Temperature Range (Ambient) | −65°C to +125°C |

Stresses above those listed under Absolute Maximum Ratings may cause permanent damage to the device. This is a stress rating only; functional operation of the device at these or any other conditions above those indicated in the operational section of this specification is not implied. Exposure to absolute maximum rating conditions for extended periods may affect device reliability.

THERMAL CHARACTERISTICS

The exposed paddle must be soldered to the ground plane for the LFCSP package. Soldering the exposed paddle to the customer board increases the reliability of the solder joints, maximizing the thermal capability of the package.

Table 7. Thermal Resistance

| Package Type | Airflow Velocity (m/sec) | $\theta_{JA}^{1,2}$ | $\theta_{JC}^{1,3}$ | $\theta_{JB}^{1,4}$ | Unit |
|--|--------------------------|---------------------|---------------------|---------------------|------|
| 32-Lead LFCSP 5 mm × 5 mm (CP-32-12) | 0 | 37.1 | 3.1 | 20.7 | °C/W |
| | 1.0 | 32.4 | | | °C/W |
| | 2.0 | 29.1 | | | °C/W |

¹ Per JEDEC 51-7, plus JEDEC 25-5 252P test board.

² Per JEDEC JESD51-2 (still air) or JEDEC JESD51-6 (moving air).

³ Per MIL-Std 883, Method 1012.1.

⁴ Per JEDEC JESD51-8 (still air).

Typical θ_{JA} is specified for a 4-layer PCB with solid ground plane. As shown in Table 7, airflow increases heat dissipation, which reduces θ_{JA} . In addition, metal in direct contact with the package leads from metal traces, through holes, ground, and power planes reduces the θ_{JA} .

ESD CAUTION



ESD (electrostatic discharge) sensitive device. Charged devices and circuit boards can discharge without detection. Although this product features patented or proprietary protection circuitry, damage may occur on devices subjected to high energy ESD. Therefore, proper ESD precautions should be taken to avoid performance degradation or loss of functionality.

PIN CONFIGURATION AND FUNCTION DESCRIPTIONS

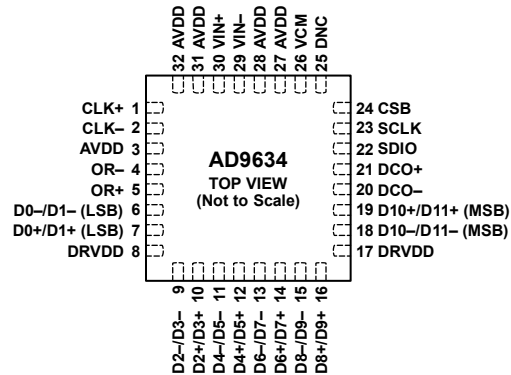

- NOTES**
1. DNC = DO NOT CONNECT. DO NOT CONNECT TO THIS PIN.
 2. THE EXPOSED THERMAL PADDLE ON THE BOTTOM OF THE PACKAGE PROVIDES THE ANALOG GROUND FOR THE PART. THIS EXPOSED PADDLE MUST BE CONNECTED TO GROUND FOR PROPER OPERATION.

06996-003

Figure 3. Pin Configuration

Table 8. Pin Function Descriptions

| Pin No. | Mnemonic | Type | Description |
|---------------------------|----------------------|--------|---|
| ADC Power Supplies | | | |
| 8, 17 | DRVDD | Supply | Digital Output Driver Supply (1.8 V Nominal). |
| 3, 27, 28, 31, 32 | AVDD | Supply | Analog Power Supply (1.8 V Nominal). |
| 0 | AGND, Exposed Paddle | Ground | Analog Ground. The exposed thermal paddle on the bottom of the package provides the analog ground for the part. This exposed paddle must be connected to ground for proper operation. |
| 25 | DNC | | Do No Connect. Do not connect to this pin. |
| ADC Analog | | | |
| 30 | VIN+ | Input | Differential Analog Input Pin (+). |
| 29 | VIN- | Input | Differential Analog Input Pin (-). |
| 26 | VCM | Output | Common-Mode Level Bias Output for Analog Inputs. This pin should be decoupled to ground using a 0.1 μ F capacitor. |
| 1 | CLK+ | Input | ADC Clock Input—True. |
| 2 | CLK- | Input | ADC Clock Input—Complement. |
| Digital Outputs | | | |
| 5 | OR+ | Output | Overrange—True. |
| 4 | OR- | Output | Overrange—Complement. |
| 7 | D0+/D1+ (LSB) | Output | DDR LVDS Output Data 0/Data 1—True (LSB). |
| 6 | D0-/D1- (LSB) | Output | DDR LVDS Output Data 0/Data 1—Complement (LSB). |
| 10 | D2+/D3+ | Output | DDR LVDS Output Data 2/Data 3—True. |
| 9 | D2-/D3- | Output | DDR LVDS Output Data 2/Data 3—Complement. |
| 12 | D4+/D5+ | Output | DDR LVDS Output Data 4/Data 5—True. |
| 11 | D4-/D5- | Output | DDR LVDS Output Data 4/Data 5—Complement. |
| 14 | D6+/D7+ | Output | DDR LVDS Output Data 6/Data 7—True. |
| 13 | D6-/D7- | Output | DDR LVDS Output Data 6/Data 7—Complement. |
| 16 | D8+/D9+ | Output | DDR LVDS Output Data 8/Data 9—True. |
| 15 | D8-/D9- | Output | DDR LVDS Output Data 8/Data 9—Complement. |
| 19 | D10+/D11+ (MSB) | Output | DDR LVDS Output Data 10/Data 11—True (MSB). |
| 18 | D10-/D11- (MSB) | Output | DDR LVDS Output Data 10/Data 11—Complement (MSB). |
| 21 | DCO+ | Output | LVDS Data Clock Output—True. |
| 20 | DCO- | Output | LVDS Data Clock Output—Complement. |

| Pin No. | Mnemonic | Type | Description |
|----------------|-----------------|--------------|-------------------------------|
| SPI Control | | | |
| 23 | SCLK | Input | SPI Serial Clock. |
| 22 | SDIO | Input/Output | SPI Serial Data I/O. |
| 24 | CSB | Input | SPI Chip Select (Active Low). |

TYPICAL PERFORMANCE CHARACTERISTICS

AVDD = 1.8 V, DRVDD = 1.8 V, sample rate = maximum sample rate per speed grade, DCS enabled, 1.75 V p-p differential input, VIN = -1.0 dBFS, 32k sample, TA = 25°C, unless otherwise noted.

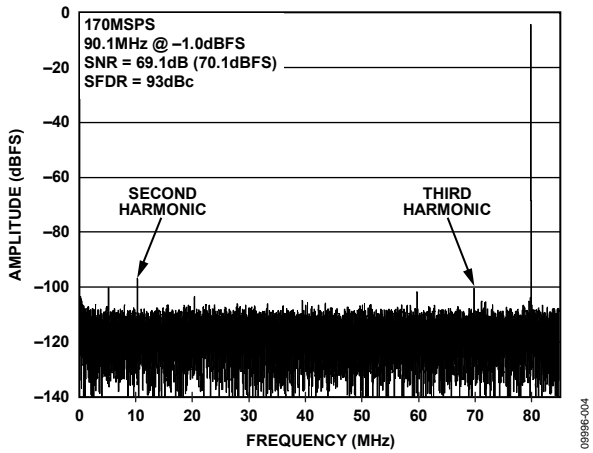

Figure 4. AD9634-170 Single-Tone FFT with $f_{IN} = 90.1$ MHz

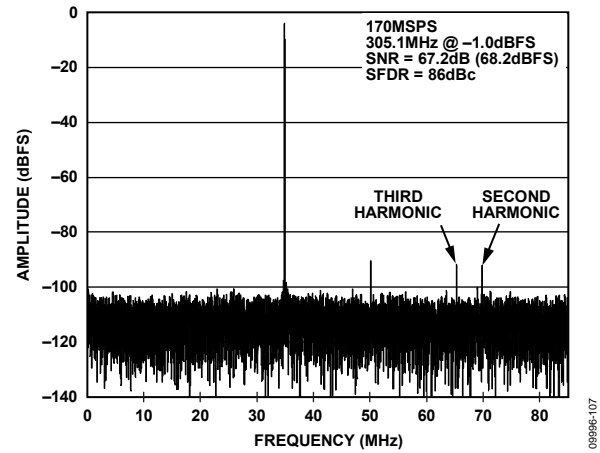

Figure 7. AD9634-170 Single-Tone FFT with $f_{IN} = 305.1$ MHz

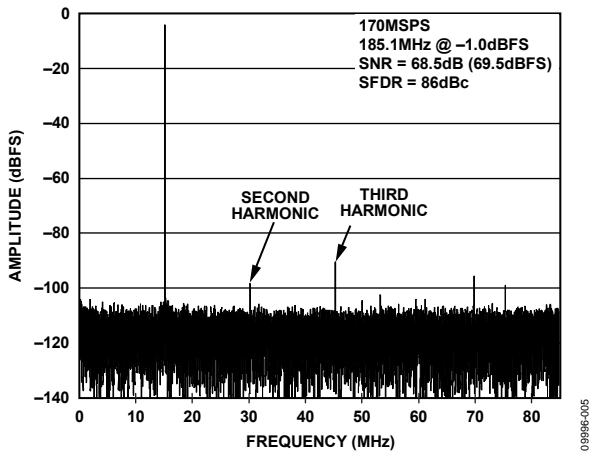

Figure 5. AD9634-170 Single-Tone FFT with $f_{IN} = 185.1$ MHz

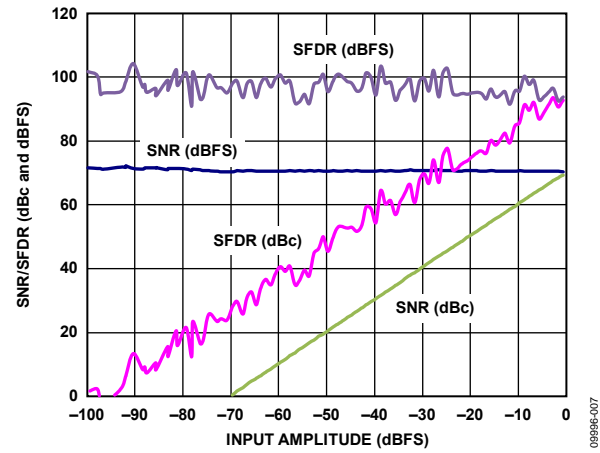

Figure 8. AD9634-170 Single-Tone SNR/SFDR vs. Input Amplitude (A_{IN}) with $f_{IN} = 90.1$ MHz, $f_s = 170$ MSPS

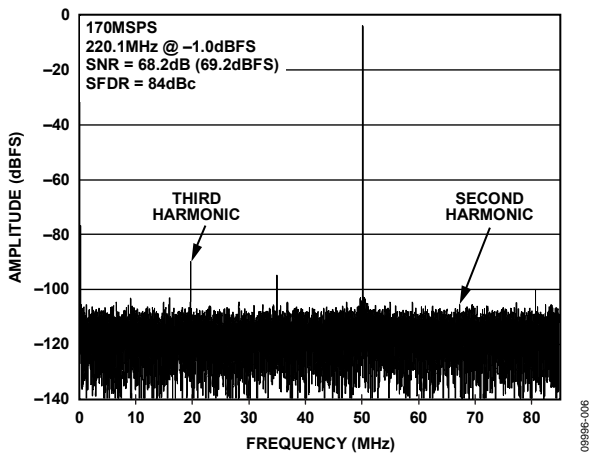

Figure 6. AD9634-170 Single-Tone FFT with $f_{IN} = 220.1$ MHz

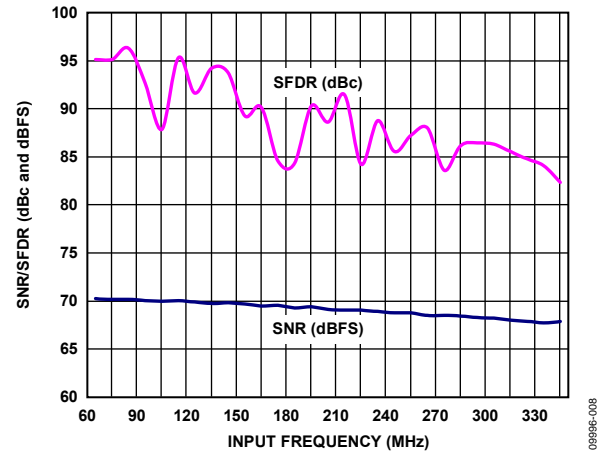

Figure 9. AD9634-170 Single-Tone SNR/SFDR vs. Input Frequency (f_{IN}), $f_s = 170$ MSPS

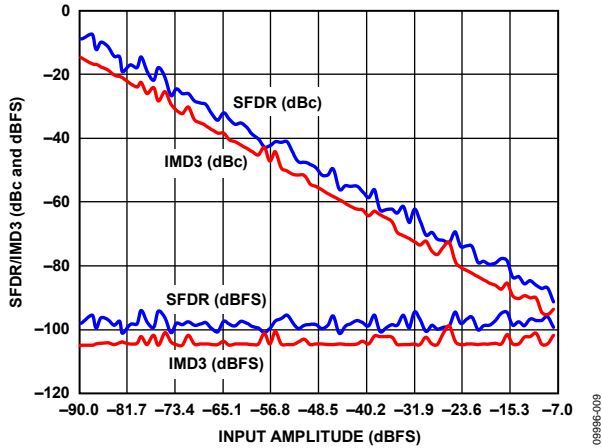

Figure 10. AD9634-170 Two-Tone SFDR/IMD3 vs. Input Amplitude (A_{IN}) with $f_{IN1} = 89.12$ MHz, $f_{IN2} = 92.12$ MHz, $f_s = 170$ MSPS

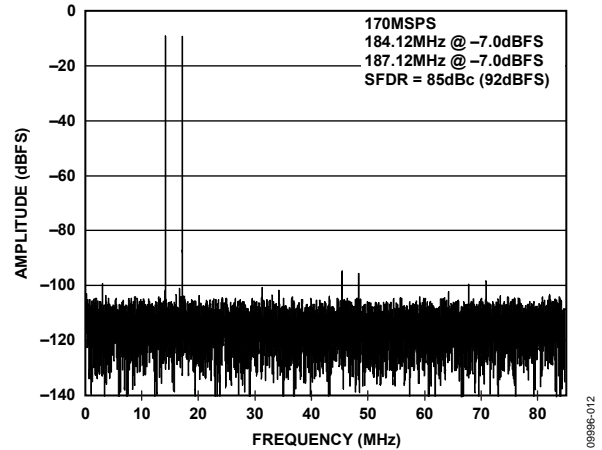

Figure 13. AD9634-170 Two Tone FFT with $f_{IN1} = 184.12$ MHz, $f_{IN2} = 187.12$ MHz

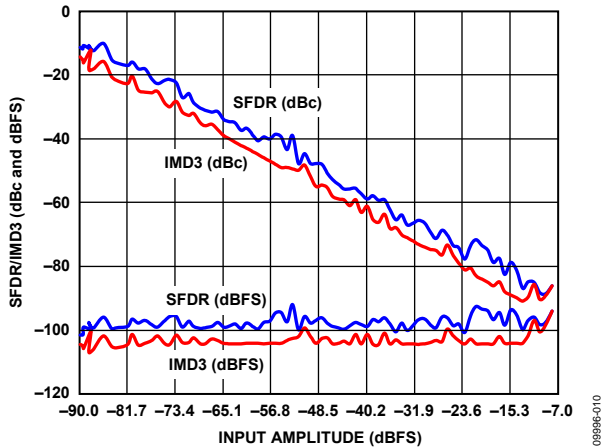

Figure 11. AD9634-170 Two-Tone SFDR/IMD3 vs. Input Amplitude (A_{IN}) with $f_{IN1} = 184.12$ MHz, $f_{IN2} = 187.12$ MHz, $f_s = 170$ MSPS

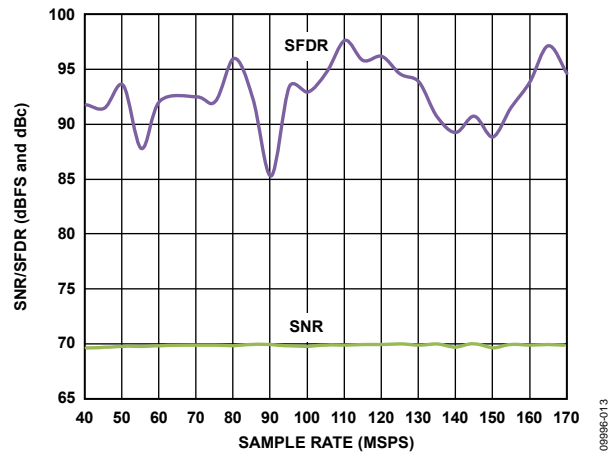

Figure 14. AD9634-170 Single-Tone SNR/SFDR vs. Sample Rate (f_s) with $f_{IN} = 90$ MHz

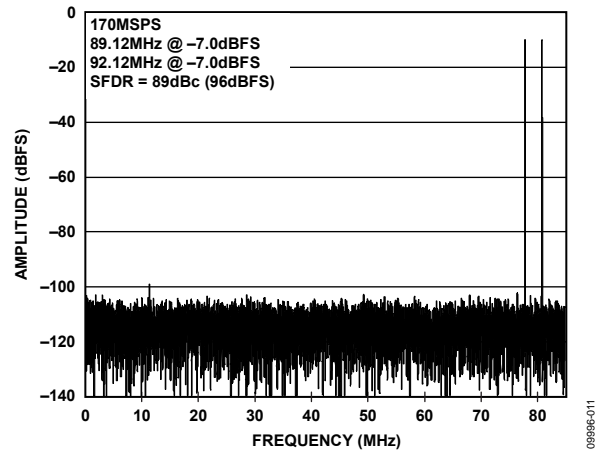

Figure 12. AD9634-170 Two-Tone FFT with $f_{IN1} = 89.12$ MHz, $f_{IN2} = 92.12$ MHz

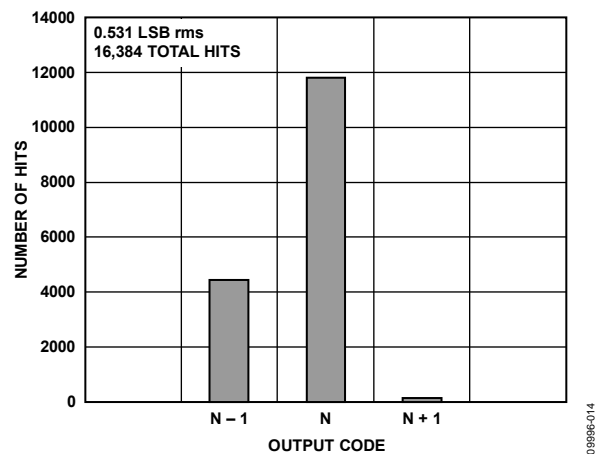

Figure 15. AD9634-170 Grounded Input Histogram, $f_s = 170$ MSPS

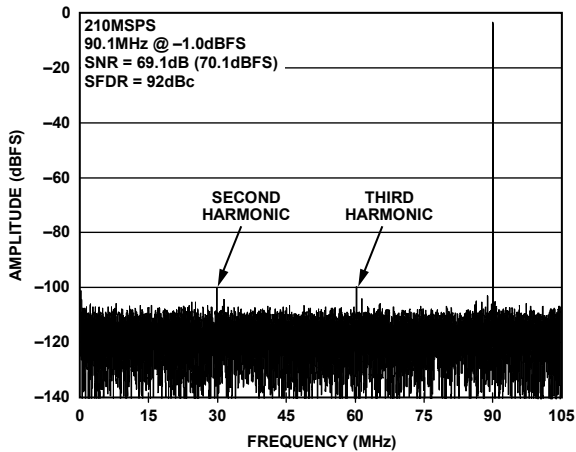

Figure 16. AD9634-210 Single-Tone FFT with $f_{IN} = 90.1$ MHz

08996-015

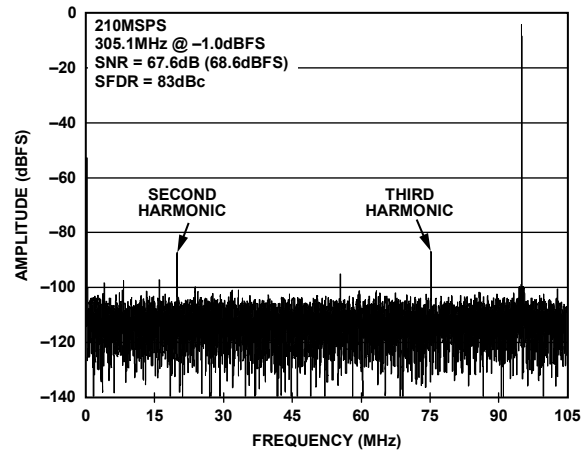

Figure 19. AD9634-210 Single-Tone FFT with $f_{IN} = 305.1$ MHz

08996-100

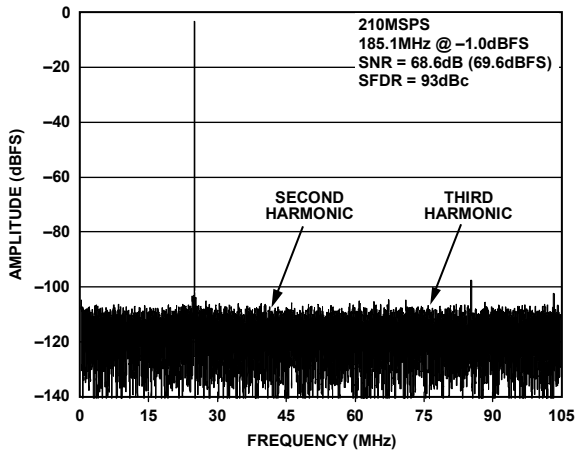

Figure 17. AD9634-210 Single-Tone FFT with $f_{IN} = 185.1$ MHz

08996-016

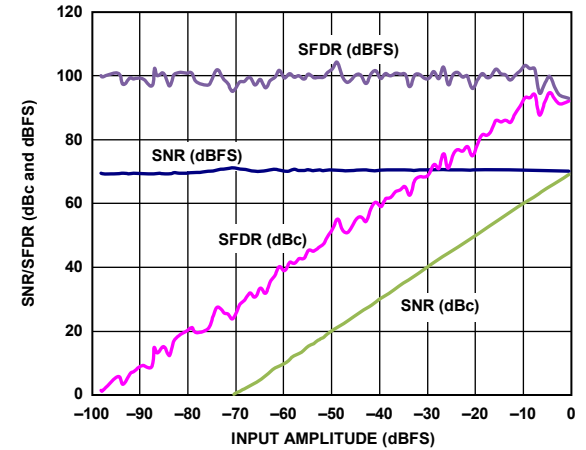

Figure 20. AD9634-210 Single-Tone SNR/SFDR vs. Input Amplitude (A_{IN}) with $f_{IN} = 90.1$ MHz, $f_s = 210$ MSPS

08996-018

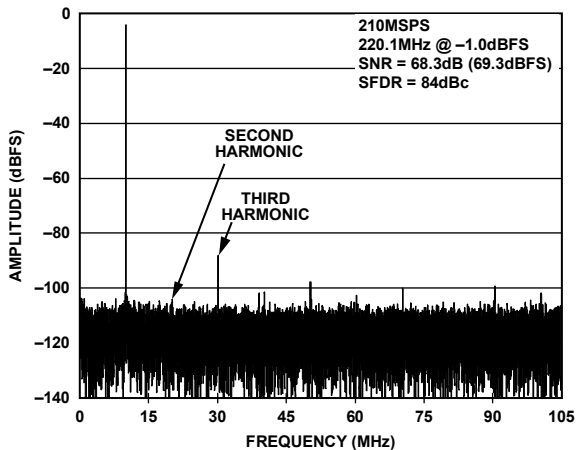

Figure 18. AD9634-210 Single-Tone FFT with $f_{IN} = 220.1$ MHz

08996-017

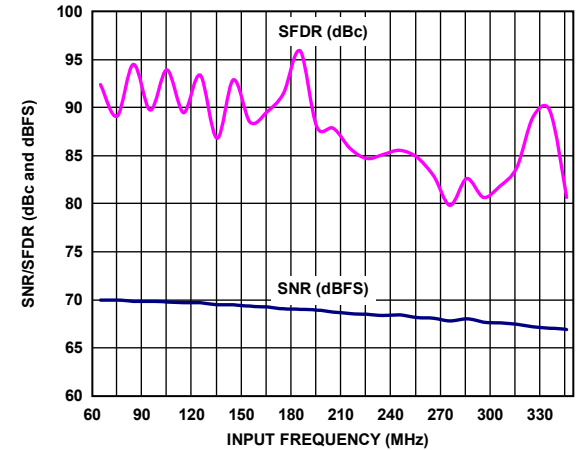

Figure 21. AD9634-210 Single-Tone SNR/SFDR vs. Input Frequency (f_{IN}), $f_s = 210$ MSPS

08996-019

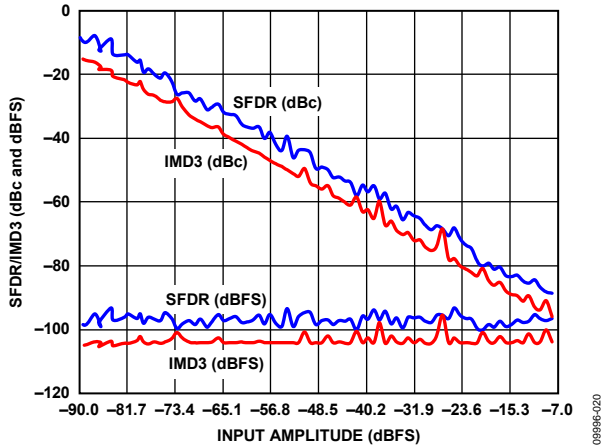

Figure 22. AD9634-210 Two-Tone SFDR/IMD3 vs. Input Amplitude (A_{IN}) with $f_{IN1} = 89.12$ MHz, $f_{IN2} = 92.12$ MHz, $f_s = 210$ MSPS

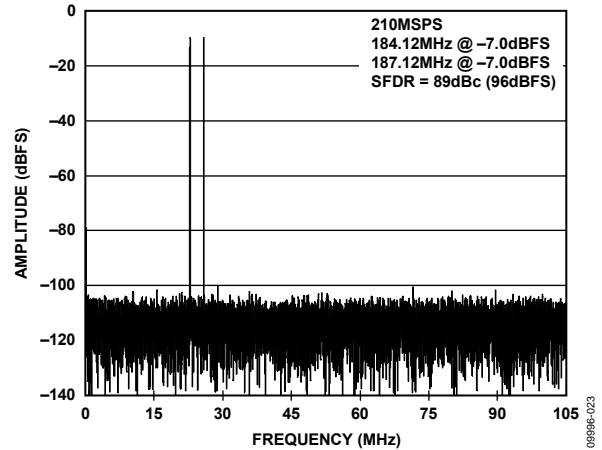

Figure 25. AD9634-210 Two Tone FFT with $f_{IN1} = 184.12$ MHz, $f_{IN2} = 187.12$ MHz

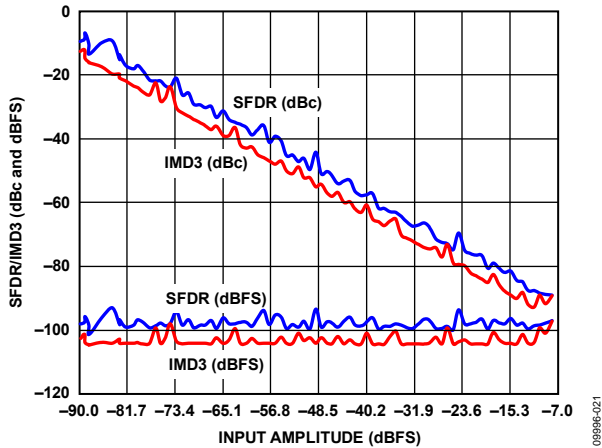

Figure 23. AD9634-210 Two-Tone SFDR/IMD3 vs. Input Amplitude (A_{IN}) with $f_{IN1} = 184.12$ MHz, $f_{IN2} = 187.12$ MHz, $f_s = 210$ MSPS

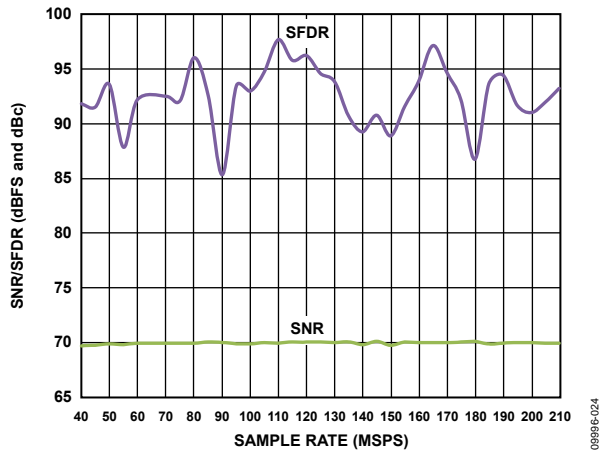

Figure 26. AD9634-210 Single-Tone SNR/SFDR vs. Sample Rate (f_s) with $f_{IN} = 90$ MHz

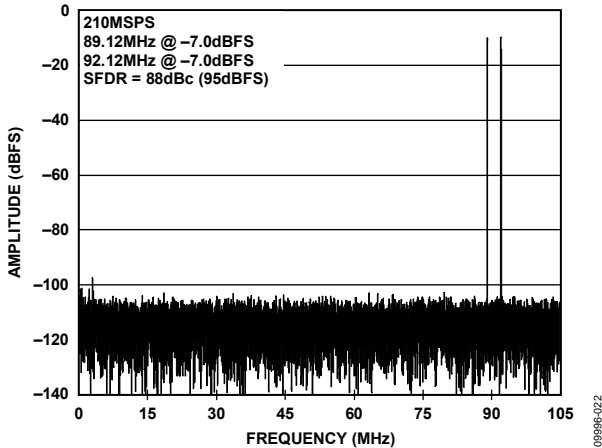

Figure 24. AD9634-210 Two-Tone FFT with $f_{IN1} = 89.12$ MHz, $f_{IN2} = 92.12$ MHz

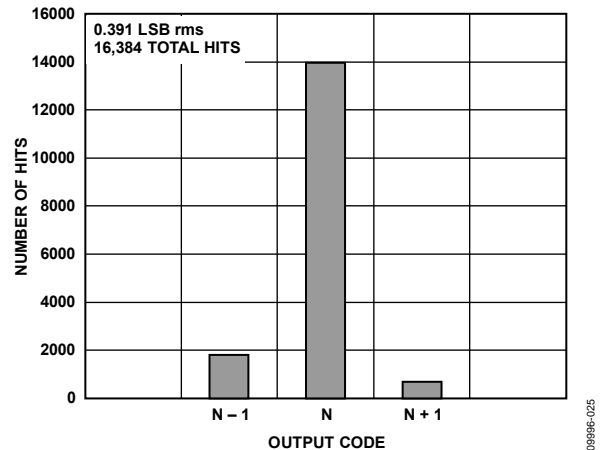

Figure 27. AD9634-210 Grounded Input Histogram, $f_s = 210$ MSPS

AD9634

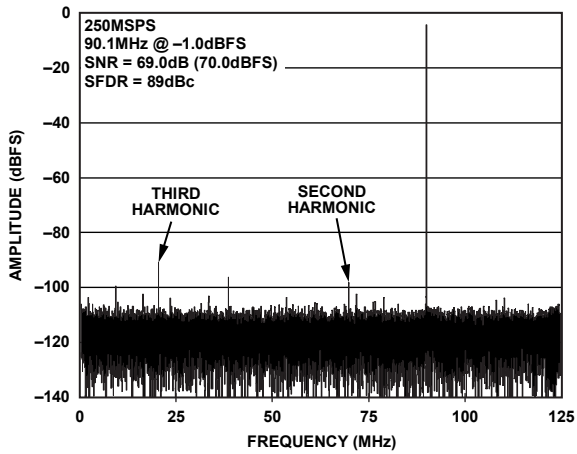

Figure 28. AD9634-250 Single-Tone FFT with $f_{IN} = 90.1$ MHz

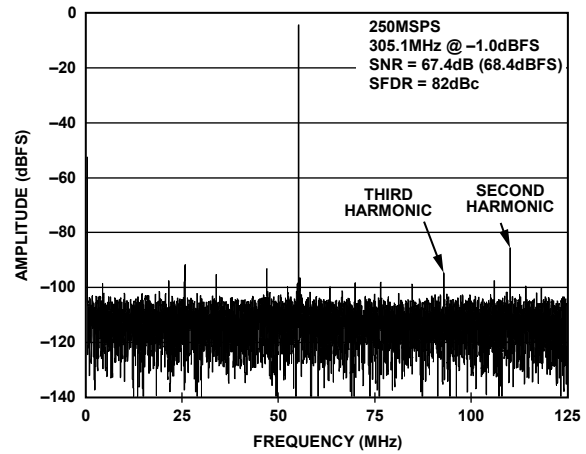

Figure 31. AD9634-250 Single-Tone FFT with $f_{IN} = 305.1$ MHz

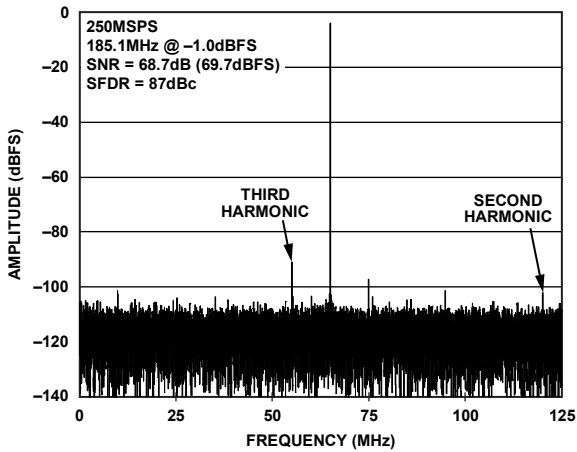

Figure 29. AD9634-250 Single-Tone FFT with $f_{IN} = 185.1$ MHz

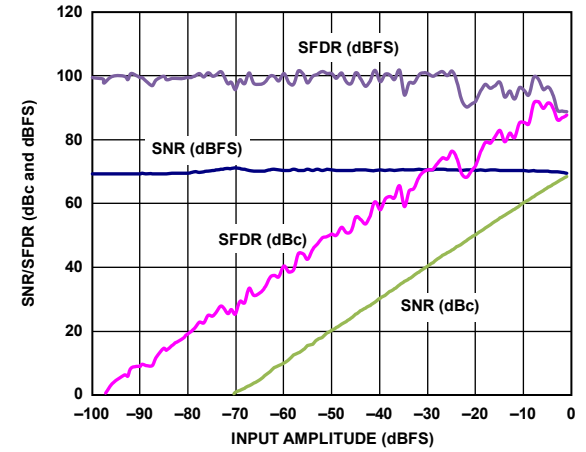

Figure 32. AD9634-250 Single-Tone SNR/SFDR vs. Input Amplitude (A_{IN}) with $f_{IN} = 90.1$ MHz, $f_s = 250$ MSPS

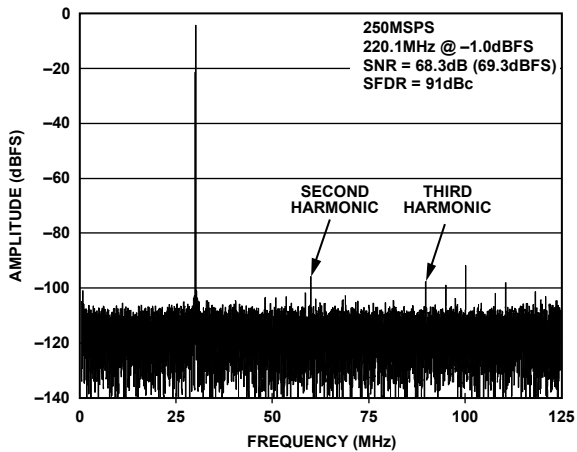

Figure 30. AD9634-250 Single-Tone FFT with $f_{IN} = 220.1$ MHz

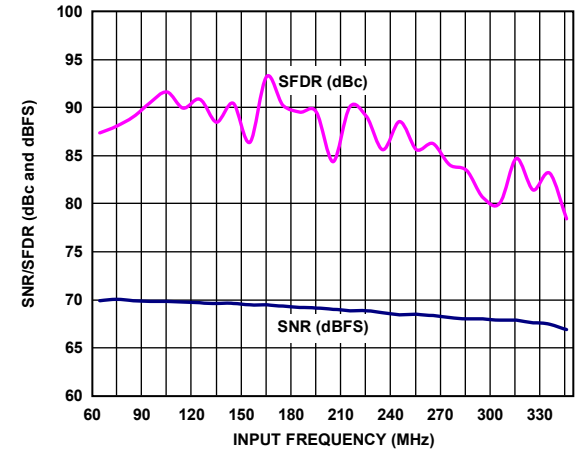

Figure 33. AD9634-250 Single-Tone SNR/SFDR vs. Input Frequency (f_{IN}), $f_s = 250$ MSPS

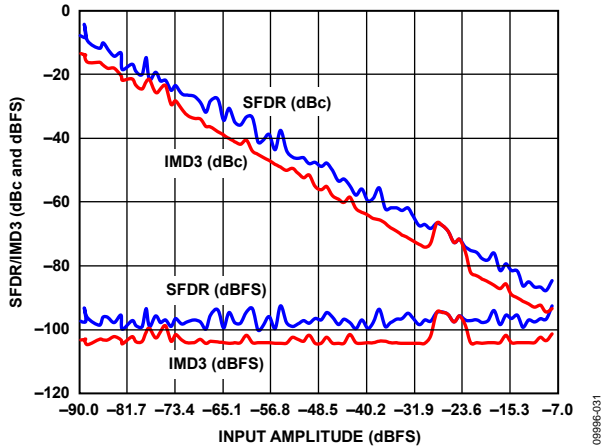

Figure 34. AD9634-250 Two-Tone SFDR/IMD3 vs. Input Amplitude (A_{IN}) with $f_{IN1} = 89.12$ MHz, $f_{IN2} = 92.12$ MHz, $f_s = 250$ MSPS

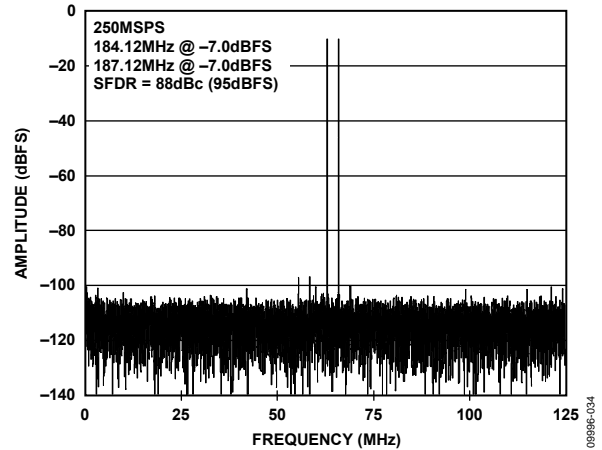

Figure 37. AD9634-250 Two Tone FFT with $f_{IN1} = 184.12$ MHz, $f_{IN2} = 187.12$ MHz

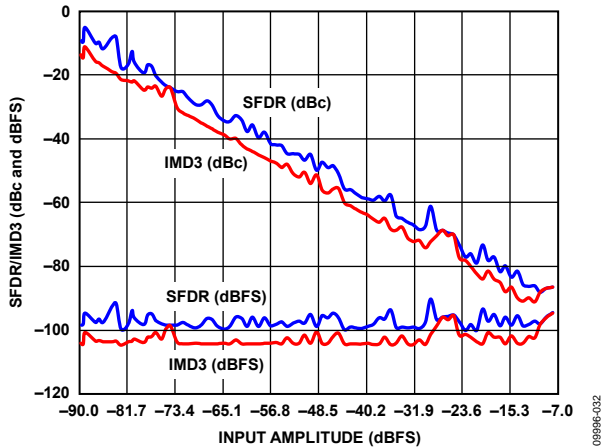

Figure 35. AD9634-250 Two-Tone SFDR/IMD3 vs. Input Amplitude (A_{IN}) with $f_{IN1} = 184.12$ MHz, $f_{IN2} = 187.12$ MHz, $f_s = 250$ MSPS

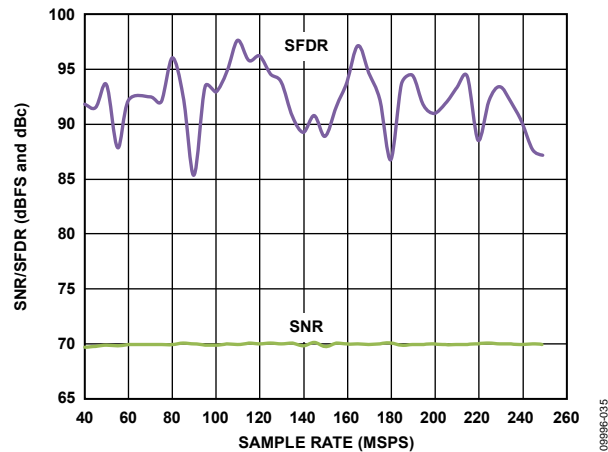

Figure 38. AD9634-250 Single-Tone SNR/SFDR vs. Sample Rate (f_s) with $f_{IN} = 90$ MHz

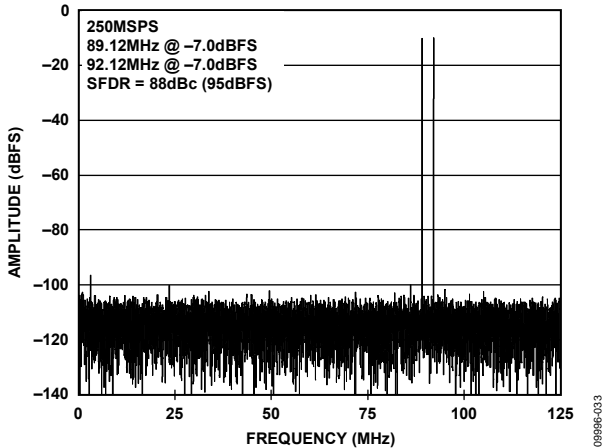

Figure 36. AD9634-250 Two-Tone FFT with $f_{IN1} = 89.12$ MHz, $f_{IN2} = 92.12$ MHz

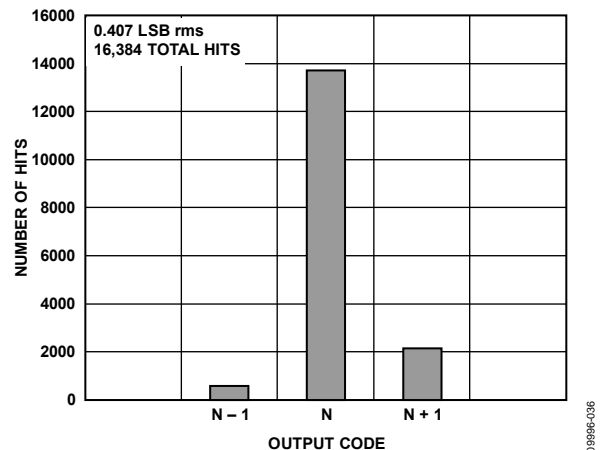

Figure 39. AD9634-250 Grounded Input Histogram, $f_s = 250$ MSPS

EQUIVALENT CIRCUITS

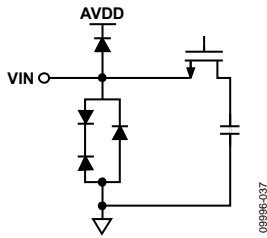

Figure 40. Equivalent Analog Input Circuit

09996-C37

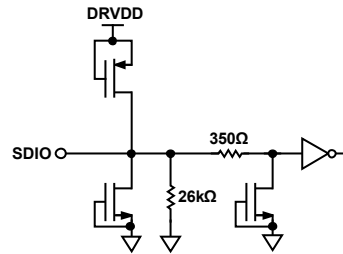

Figure 43. Equivalent SDIO Circuit

09996-C40

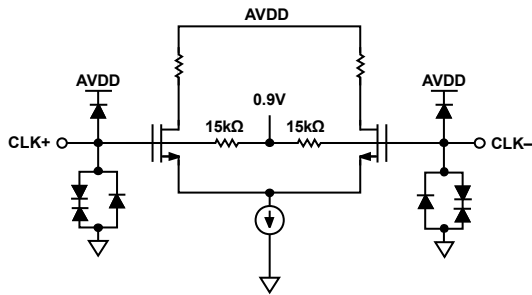

Figure 41. Equivalent Clock Input Circuit

09996-C38

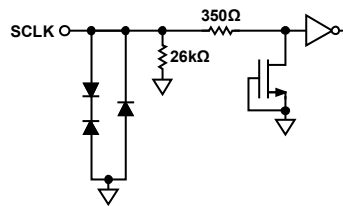

Figure 44. Equivalent SCLK Input Circuit

09996-C41

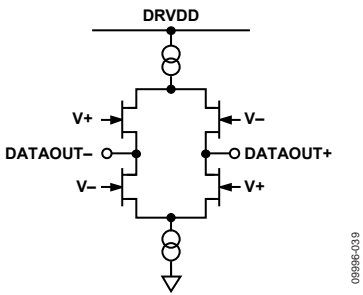

Figure 42. Equivalent LVDS Output Circuit

09996-C39

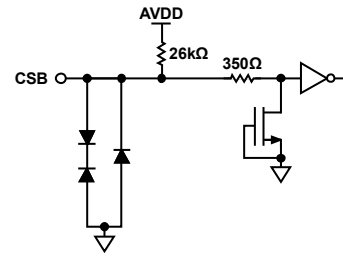

Figure 45. Equivalent CSB Input Circuit

09996-C42

THEORY OF OPERATION

The AD9634 can sample any $f_s/2$ frequency segment from dc to 250 MHz using appropriate low-pass or band-pass filtering at the ADC inputs with little loss in ADC performance.

Programming and control of the AD9634 are accomplished using a 3-pin, SPI-compatible serial interface.

ADC ARCHITECTURE

The AD9634 architecture consists of a front-end sample-and-hold circuit, followed by a pipelined, switched-capacitor ADC. The quantized outputs from each stage are combined into a final 12-bit result in the digital correction logic. The pipelined architecture permits the first stage to operate on a new input sample and the remaining stages to operate on the preceding samples. Sampling occurs on the rising edge of the clock.

Each stage of the pipeline, excluding the last, consists of a low resolution flash ADC connected to a switched-capacitor digital-to-analog converter (DAC) and an interstage residue amplifier (MDAC). The MDAC magnifies the difference between the reconstructed DAC output and the flash input for the next stage in the pipeline. One bit of redundancy is used in each stage to facilitate digital correction of flash errors. The last stage simply consists of a flash ADC.

The input stage contains a differential sampling circuit that can be ac- or dc-coupled in differential or single-ended modes. The output staging block aligns the data, corrects errors, and passes the data to the output buffers. The output buffers are powered from a separate supply, allowing digital output noise to be separated from the analog core. During power-down, the output buffers go into a high impedance state.

ANALOG INPUT CONSIDERATIONS

The analog input to the AD9634 is a differential switched-capacitor circuit that has been designed to attain optimum performance when processing a differential input signal.

The clock signal alternatively switches the input between sample mode and hold mode (see the configuration shown in Figure 46). When the input is switched into sample mode, the signal source must be capable of charging the sampling capacitors and settling within $\frac{1}{2}$ clock cycle.

A small resistor in series with each input can help reduce the peak transient current required from the output stage of the driving source. A shunt capacitor can be placed across the inputs to provide dynamic charging currents. This passive network creates a low-pass filter at the ADC input; therefore, the precise values are dependent on the application.

In intermediate frequency (IF) undersampling applications, reduce the shunt capacitors. In combination with the driving source impedance, the shunt capacitors limit the input bandwidth. Refer to the AN-742 Application Note, *Frequency Domain Response of Switched-Capacitor ADCs*; the AN-827 Application Note, *A Resonant Approach to Interfacing Amplifiers to Switched-Capacitor ADCs*; and the Analog Dialogue article, “Transformer-Coupled Front-End for Wideband A/D Converters” for more information on this subject.

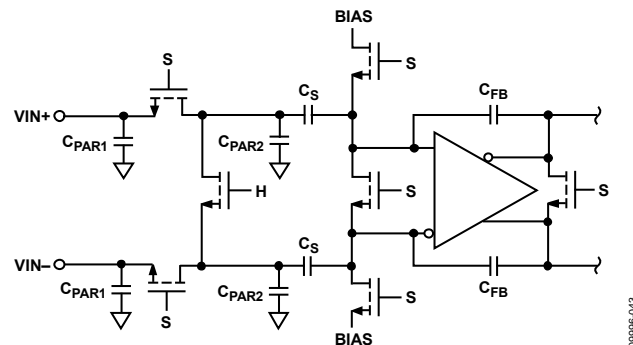

Figure 46. Switched-Capacitor Input

For best dynamic performance, match the source impedances driving VIN+ and VIN- and differentially balance the inputs.

Input Common Mode

The analog inputs of the AD9634 are not internally dc biased. In ac-coupled applications, the user must provide this bias externally. Setting the device so that $V_{CM} = 0.5 \times AVDD$ (or 0.9 V) is recommended for optimum performance. An on-board common-mode voltage reference is included in the design and is available from the VCM pin. Using the VCM output to set the input common mode is recommended. Optimum performance is achieved when the common-mode voltage of the analog input is set by the VCM pin voltage (typically $0.5 \times AVDD$). The VCM pin must be decoupled to ground by a 0.1 μF capacitor, as described in the Applications Information section. Place this decoupling capacitor close to the pin to minimize the series resistance and inductance between the part and this capacitor.

AD9634

Differential Input Configurations

Optimum performance can be achieved when driving the AD9634 in a differential input configuration. For baseband applications, the AD8138, ADA4937-1, and ADA4930-1 differential drivers provide excellent performance and a flexible interface to the ADC.

The output common-mode voltage of the ADA4930-1 is easily set with the VCM pin of the AD9634 (see Figure 47), and the driver can be configured in a Sallen-Key filter topology to provide band limiting of the input signal.

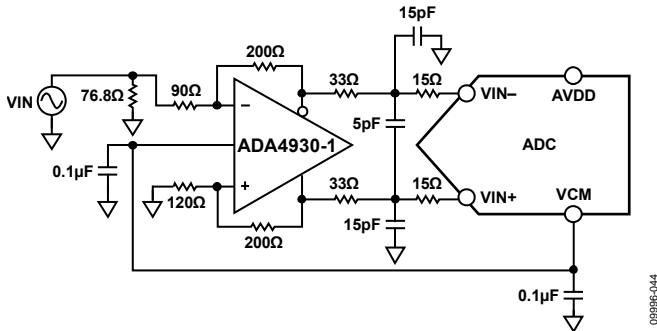

Figure 47. Differential Input Configuration Using the ADA4930-1

For baseband applications where SNR is a key parameter, differential transformer coupling is the recommended input configuration. An example is shown in Figure 48. To bias the analog input, connect the VCM voltage to the center tap of the secondary winding of the transformer.

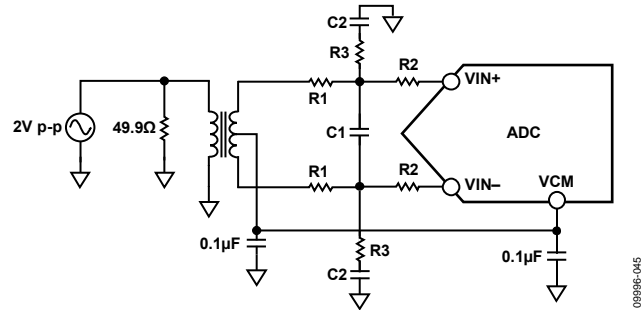

Figure 48. Differential Transformer-Coupled Configuration

The signal characteristics must be considered when selecting a transformer. Most RF transformers saturate at frequencies below a few megahertz. Excessive signal power can also cause core saturation, which leads to distortion.

At input frequencies in the second Nyquist zone and above, the noise performance of most amplifiers is not adequate to achieve the true SNR performance of the AD9634. For applications where SNR is a key parameter, differential double balun coupling is the recommended input configuration (see Figure 49). In this configuration, the input is ac-coupled and the VCM voltage is provided to each input through a 33Ω resistor. These resistors compensate for losses in the input baluns to provide a 50Ω impedance to the driver.

In the double balun and transformer configurations, the value of the input capacitors and resistors is dependent on the input frequency and source impedance. Based on these parameters the value of the input resistors and capacitors may need to be adjusted, or some components may need to be removed. Table 9 displays recommended values to set the RC network for different input frequency ranges. However, these values are dependent on the input signal and bandwidth and should be used only as a starting guide. Note that the values given in Table 9 are for the R1, R2, R3, C1, and C2 components shown in Figure 49.

Table 9. Example RC Network

| Frequency Range (MHz) | R1 Series (Ω) | C1 Differential (pF) | R2 Series (Ω) | C2 Shunt (pF) | R3 Shunt (Ω) |
|-----------------------|---------------|----------------------|---------------|---------------|--------------|
| 0 to 100 | 33 | 8.2 | 0 | 15 | 49.9 |
| 100 to 300 | 15 | 3.9 | 0 | 8.2 | 49.9 |

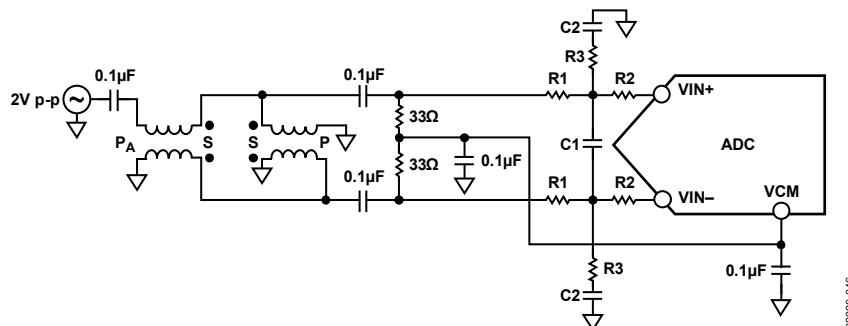
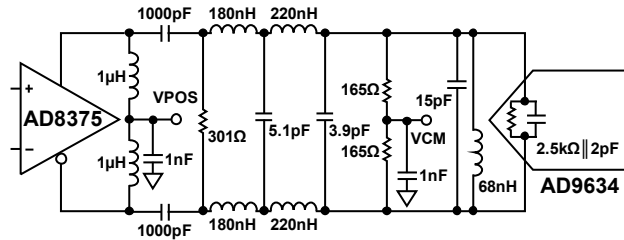

Figure 49. Differential Double Balun Input Configuration



- NOTES
1. ALL INDUCTORS ARE COILCRAFT 0603CS COMPONENTS WITH THE EXCEPTION OF THE 1μH CHOKE INDUCTORS (0603LS).
 2. FILTER VALUES SHOWN ARE FOR A 20MHz BANDWIDTH FILTER CENTERED AT 140MHz.

00996-047

Figure 50. Differential Input Configuration Using the AD8375

An alternative to using a transformer-coupled input at frequencies in the second Nyquist zone is to use an amplifier with variable gain. The AD8375 digital variable gain amplifier (DVGA) provides good performance for driving the AD9634. Figure 50 shows an example of the AD8375 driving the AD9634 through a band-pass antialiasing filter.

VOLTAGE REFERENCE

A stable and accurate voltage reference is built into the AD9634. The full-scale input range can be adjusted by varying the reference voltage via SPI. The input span of the ADC tracks reference voltage changes linearly.

CLOCK INPUT CONSIDERATIONS

For optimum performance, the AD9634 sample clock inputs, CLK+ and CLK-, should be clocked with a differential signal. The signal is typically ac-coupled into the CLK+ and CLK- pins by means of a transformer or a passive component configuration. These pins are biased internally (see Figure 51) and require no external bias. If the inputs are floated, the CLK- pin is pulled low to prevent spurious clocking.

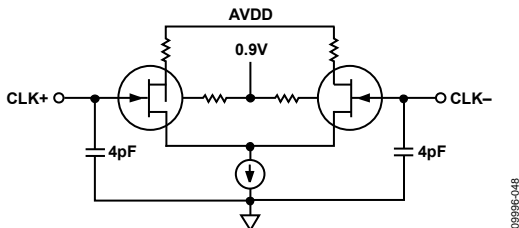

Figure 51. Equivalent Clock Input Circuit

Clock Input Options

The AD9634 has a very flexible clock input structure. Clock input can be a CMOS, LVDS, LVPECL, or sine wave signal. Regardless of the type of signal being used, clock source jitter is of the most concern, as described in the Jitter Considerations section.

Figure 52 and Figure 53 show two preferable methods for clocking the AD9634 (at clock rates of up to 625 MHz). A low jitter clock source is converted from a single-ended signal to a differential signal using an RF balun or RF transformer.

The RF balun configuration is recommended for clock frequencies between 125 MHz and 625 MHz, and the RF transformer is recommended for clock frequencies from 10 MHz to 200 MHz. The back-to-back Schottky diodes across the secondary windings of the transformer limit clock excursions into the AD9634 to approximately 0.8 V p-p differential. This limit helps prevent the large voltage swings of the clock from feeding through to other portions of the AD9634, while preserving the fast rise and fall times of the signal, which are critical for low jitter performance.

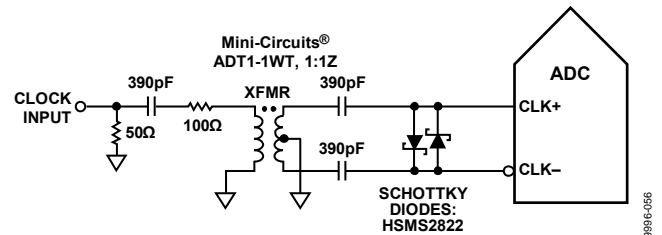

Figure 52. Transformer Coupled Differential Clock (Up to 200 MHz)

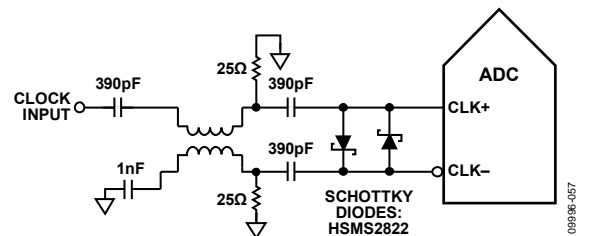

Figure 53. Balun-Coupled Differential Clock (Up to 625 MHz)

If a low jitter clock source is not available, another option is to ac couple a differential PECL signal to the sample clock input pins as shown in Figure 54. The AD9510, AD9511, AD9512, AD9513, AD9514, AD9515, AD9516, AD9517, AD9518, AD9520, AD9522, AD9523, AD9524, ADCLK905, ADCLK907, and ADCLK925 clock drivers offer excellent jitter performance.

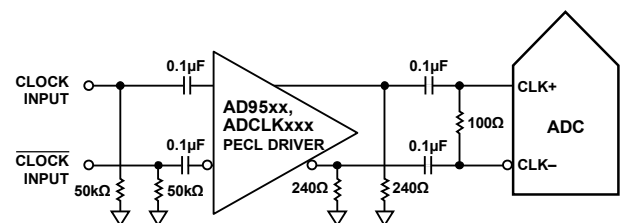

Figure 54. Differential PECL Sample Clock (Up to 625 MHz)

AD9634

A third option is to ac couple a differential LVDS signal to the sample clock input pins, as shown in Figure 55. The [AD9510](#), [AD9511](#), [AD9512](#), [AD9513](#), [AD9514](#), [AD9515](#), [AD9516](#), [AD9517](#), [AD9518](#), [AD9520](#), [AD9522](#), [AD9523](#), [AD9524](#) clock drivers offer excellent jitter performance.

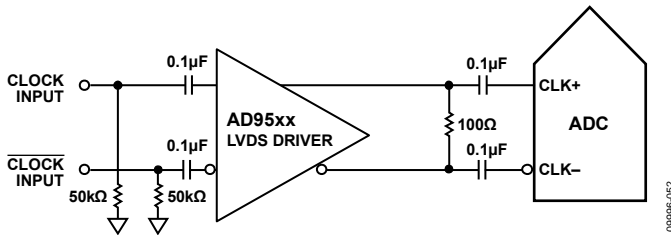

Figure 55. Differential LVDS Sample Clock (Up to 625 MHz)

Input Clock Divider

The [AD9634](#) contains an input clock divider with the ability to divide the input clock by integer values between 1 and 8. For divide ratios other than 1, the DCS is enabled by default on power-up.

Clock Duty Cycle

Typical high speed ADCs use both clock edges to generate a variety of internal timing signals and, as a result, may be sensitive to clock duty cycle. Commonly, a $\pm 5\%$ tolerance is required on the clock duty cycle to maintain dynamic performance characteristics.

The [AD9634](#) contains a DCS that retimes the nonsampling (falling) edge, providing an internal clock signal with a nominal 50% duty cycle. This allows the user to provide a wide range of clock input duty cycles without affecting the performance of the [AD9634](#).

Jitter on the rising edge of the input clock is still of paramount concern and is not reduced by the duty cycle stabilizer. The duty cycle control loop does not function for clock rates less than 40 MHz nominally. The loop has a time constant associated with it that must be considered when the clock rate may change dynamically. A wait time of 1.5 μs to 5 μs is required after a dynamic clock frequency increase or decrease before the DCS loop is relocked to the input signal. During the time that the loop is not locked, the DCS loop is bypassed, and internal device timing is dependent on the duty cycle of the input clock signal. In such applications, it may be appropriate to disable the duty cycle stabilizer. In all other applications, enabling the DCS circuit is recommended to maximize ac performance.

Jitter Considerations

High speed, high resolution ADCs are sensitive to the quality of the clock input. The degradation in SNR at a given input frequency (f_{IN}) due to jitter (t_j) can be calculated by

$$SNR_{HF} = -10 \log[(2\pi \times f_{IN} \times t_{jRMS})^2 + 10^{(-SNR_{LF}/10)}]$$

In the equation, the rms aperture jitter represents the root-mean-square of all jitter sources, which include the clock input, the analog input signal, and the ADC aperture jitter specification. IF undersampling applications are particularly sensitive to jitter, as shown in Figure 56.

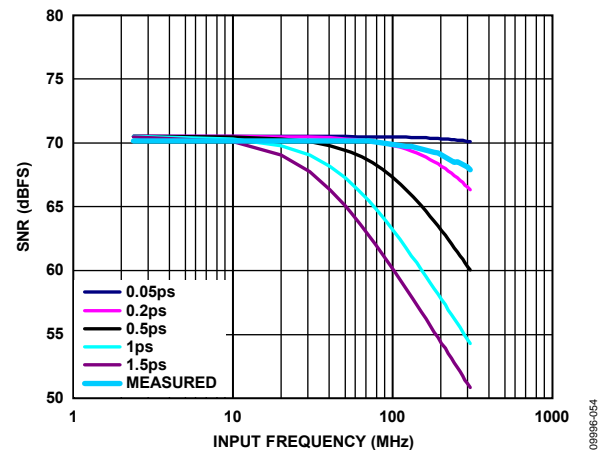

Figure 56. AD9634-250 SNR vs. Input Frequency and Jitter

In cases where aperture jitter may affect the dynamic range of the [AD9634](#), treat the clock input as an analog signal. In addition, use separate power supplies for the clock drivers and the ADC output driver to avoid modulating the clock signal with digital noise. Low jitter, crystal controlled oscillators provide the best clock sources. If the clock is generated from another type of source (by gating, dividing, or another method), it should be retimed by the original clock during the last step.

Refer to [AN-501 Application Note, Aperture Uncertainty and ADC System Performance](#), and [AN-756 Application Note, Sampled Systems and the Effects of Clock Phase Noise and Jitter](#), for more information about jitter performance as it relates to ADCs.

POWER DISSIPATION AND STANDBY MODE

As shown in Figure 57, the power dissipated by the AD9634 is proportional to its sample rate. The data in Figure 57 was taken using the same operating conditions as those used for the Typical Performance Characteristics section.

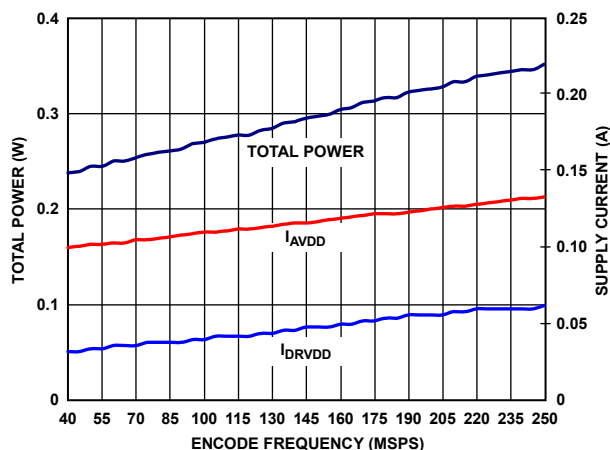

Figure 57. AD9634-250 Power and Current vs. Sample Rate

By setting the internal power-down mode bits (Bits[1:0]) in the power modes register (Address 0x08) to 01, the AD9634 is placed in power-down mode. In this state, the ADC typically dissipates 5 mW. During power-down, the output drivers are placed in a high impedance state.

Low power dissipation in power-down mode is achieved by shutting down the reference, reference buffer, biasing networks, and clock. Internal capacitors are discharged when entering power-down mode and then must be recharged when returning to normal operation. As a result, wake-up time is related to the time spent in power-down mode, and shorter power-down cycles result in proportionally shorter wake-up times.

When using the SPI port interface, the user can place the ADC in power-down mode or standby mode. Standby mode allows the user to keep the internal reference circuitry powered when faster wake-up times are required. To put the part into standby mode, set the internal power-down mode bits (Bits[1:0]) in the power modes register (Address 0x08) to 10. See the Memory Map section and [AN-877 Application Note, Interfacing to High Speed ADCs via SPI](#) for additional details.

DIGITAL OUTPUTS

The AD9634 output drivers can be configured for either ANSI LVDS or reduced swing LVDS using a 1.8 V DRVDD supply.

As detailed in the [AN-877 Application Note, Interfacing to High Speed ADCs via SPI](#), the data format can be selected for offset binary, twos complement, or gray code when using the SPI control.

Digital Output Enable Function (OEB)

The AD9634 has a flexible three-state ability for the digital output pins. The three-state mode is enabled using the SPI interface. The data outputs can be three-stated by using the output enable bar bit (Bit 4) in Register 0x14. This OEB function is not intended for rapid access to the data bus.

Timing

The AD9634 provides latched data with a pipeline delay of 10 input sample clock cycles. Data outputs are available one propagation delay (t_{PD}) after the rising edge of the clock signal.

Minimize the length of the output data lines as well as the loads placed on these lines to reduce transients within the AD9634. These transients may degrade converter dynamic performance.

The lowest typical conversion rate of the AD9634 is 40 MSPS. At clock rates below 40 MSPS, dynamic performance can degrade.

Data Clock Output (DCO)

The AD9634 also provides the data clock output (DCO) intended for capturing the data in an external register. Figure 2 shows timing diagram of the AD9634 output modes.

ADC OVERRANGE (OR)

The ADC overrange indicator is asserted when an overrange is detected on the input of the ADC. The overrange condition is determined at the output of the ADC pipeline and, therefore, is subject to a latency of 10 ADC clock cycles. An overrange at the input is indicated by this bit 10 clock cycles after it occurs.

Table 10. Output Data Format

| Input (V) | VIN+ – VIN–, Input Span = 1.75 V p-p (V) | Offset Binary Output Mode | Twos Complement Mode (Default) | OR |
|-------------|--|---------------------------|--------------------------------|----|
| VIN+ – VIN– | < –0.875 | 0000 0000 0000 | 1000 0000 0000 | 1 |
| VIN+ – VIN– | = –0.875 | 0000 0000 0000 | 1000 0000 0000 | 0 |
| VIN+ – VIN– | = 0 | 1000 0000 0000 | 0000 0000 0000 | 0 |
| VIN+ – VIN– | = +0.875 | 1111 1111 1111 | 0111 1111 1111 | 0 |
| VIN+ – VIN– | > +0.875 | 1111 1111 1111 | 0111 1111 1111 | 1 |

SERIAL PORT INTERFACE (SPI)

The AD9634 serial port interface (SPI) allows the user to configure the converter for specific functions or operations through a structured register space provided inside the ADC. The SPI offers added flexibility and customization, depending on the application. Addresses are accessed via the serial port and can be written to or read from via the port. Memory is organized into bytes that can be further divided into fields. These fields are documented in the Memory Map section. For detailed operational information, see the [AN-877 Application Note, Interfacing to High Speed ADCs via SPI](#).

CONFIGURATION USING THE SPI

Three pins define the SPI of this ADC: the SCLK pin, the SDIO pin, and the CSB pin (see Table 11). The SCLK (serial clock) pin is used to synchronize the read and write data presented from and to the ADC. The SDIO (serial data input/output) pin is a dual-purpose pin that allows data to be sent and read from the internal ADC memory map registers. The CSB (chip select bar) pin is an active-low control that enables or disables the read and write cycles.

Table 11. Serial Port Interface Pins

| Pin | Function |
|------|---|
| SCLK | Serial clock. The serial shift clock input, which is used to synchronize serial interface reads and writes. |
| SDIO | Serial data input/output. A dual-purpose pin that typically serves as an input or an output, depending on the instruction being sent and the relative position in the timing frame. |
| CSB | Chip select bar. An active-low control that gates the read and write cycles. |

The falling edge of CSB, in conjunction with the rising edge of SCLK, determines the start of the framing. An example of the serial timing and its definitions can be found in Figure 58 and Table 5.

Other modes involving the CSB are available. The CSB can be held low indefinitely, which permanently enables the device; this is called streaming. The CSB can stall high between bytes to allow for additional external timing. When CSB is tied high, SPI functions are placed in a high impedance mode. This mode turns on any SPI pin secondary functions.

During an instruction phase, a 16-bit instruction is transmitted. Data follows the instruction phase, and its length is determined by the W0 and W1 bits.

All data is composed of 8-bit words. The first bit of each individual byte of serial data indicates whether a read or write command is issued. This allows the serial data input/output (SDIO) pin to change direction from an input to an output.

In addition to word length, the instruction phase determines whether the serial frame is a read or write operation, allowing the serial port to be used both to program the chip and to read the contents of the on-chip memory. If the instruction is a readback operation, performing a readback causes the serial data input/output (SDIO) pin to change direction from an input to an output at the appropriate point in the serial frame.

Data can be sent in MSB-first mode or in LSB-first mode. MSB-first mode is the default on power-up and can be changed via the SPI port configuration register. For more information about this and other features, see the [AN-877 Application Note, Interfacing to High Speed ADCs via SPI](#).

HARDWARE INTERFACE

The pins described in Table 11 comprise the physical interface between the user programming device and the serial port of the AD9634. The SCLK pin and the CSB pin function as inputs when using the SPI interface. The SDIO pin is bidirectional, functioning as an input during write phases and as an output during readback.

The SPI interface is flexible enough to be controlled by either FPGAs or microcontrollers. One method for SPI configuration is described in detail in the [AN-812 Application Note, Microcontroller-Based Serial Port Interface \(SPI\) Boot Circuit](#).

The SPI port should not be active during periods when the full dynamic performance of the converter is required. Because the SCLK signal, the CSB signal, and the SDIO signal are typically asynchronous to the ADC clock, noise from these signals can degrade converter performance. If the on-board SPI bus is used for other devices, it may be necessary to provide buffers between this bus and the AD9634 to prevent these signals from transitioning at the converter inputs during critical sampling periods.

SPI ACCESSIBLE FEATURES

Table 12 provides a brief description of the general features that are accessible via the SPI. These features are described in detail in [AN-877 Application Note, Interfacing to High Speed ADCs via SPI](#).

Table 12. Features Accessible Using the SPI

| Feature Name | Description |
|--------------------|---|
| Mode | Allows the user to set either power-down mode or standby mode |
| Clock | Allows the user to access the DCS via the SPI |
| Offset | Allows the user to digitally adjust the converter offset |
| Test I/O | Allows the user to set test modes to have known data on output bits |
| Output Mode | Allows the user to set up outputs |
| Output Phase | Allows the user to set the output clock polarity |
| Output Delay | Allows the user to vary the DCO delay |
| VREF | Allows the user to set the reference voltage |
| Digital Processing | Allows the user to enable the synchronization features |

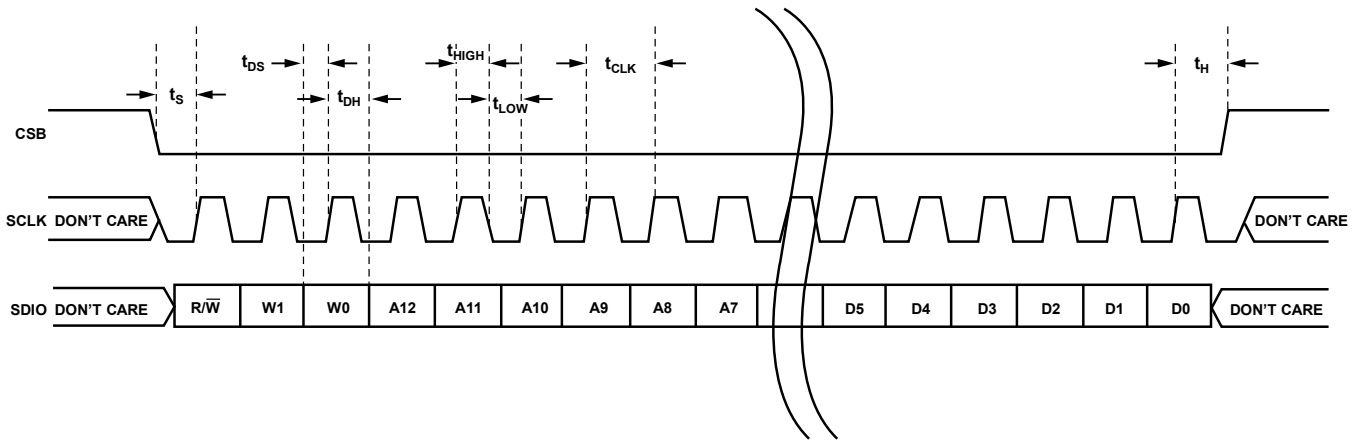

Figure 58. Serial Port Interface Timing Diagram

0096455

MEMORY MAP

READING THE MEMORY MAP REGISTER TABLE

Each row in the memory map register table has eight bit locations. The memory map is roughly divided into three sections: the chip configuration registers (Address 0x00 to Address 0x02), the transfer register (Address 0xFF), and the ADC functions registers (Address 0x08 to Address 0x25), including setup, control, and test.

The memory map register table (Table 13) documents the default hexadecimal value for each hexadecimal address shown. The Bit 7 (MSB) column is the start of the default hexadecimal value given. For example, Address 0x14, the output mode register, has a hexadecimal default value of 0x01. This means that Bit 0 = 1 and the remaining bits are 0s. This setting is the default output format value, which is twos complement. For more information on this function and others, see the [AN-877 Application Note, Interfacing to High Speed ADCs via SPI](#). This document details the functions controlled by Register 0x00 to Register 0x25.

Open Locations

All address and bit locations that are not included in Table 13 are not currently supported for this device. Write 0s to unused bits of a valid address location. Writing to these locations is required only when part of an address location is open (for example, Address 0x18). If the entire address location is open (for example, Address 0x13), do not write to this address location.

Default Values

After the [AD9634](#) is reset, critical registers are loaded with default values. The default values for the registers are given in the memory map register table (see Table 13).

Logic Levels

An explanation of logic level terminology follows:

- “Bit is set” is synonymous with “bit is set to Logic 1” or “writing Logic 1 for the bit.”
- “Clear a bit” is synonymous with “bit is set to Logic 0” or “writing Logic 0 for the bit.”

Transfer Register Map

Address 0x08 to Address 0x20 are shadowed. Writes to these addresses do not affect part operation until a transfer command is issued by writing 0x01 to Address 0xFF, setting the transfer bit. This allows these registers to be updated internally and simultaneously when the transfer bit is set. The internal update takes place when the transfer bit is set, and then the bit autoclears.

MEMORY MAP REGISTER TABLE

All address and bit locations that are not included in Table 13 are not currently supported for this device.

Table 13. Memory Map Registers

| Addr (Hex) | Register Name | Bit 7 (MSB) | Bit 6 | Bit 5 | Bit 4 | Bit 3 | Bit 2 | Bit 1 | Bit 0 (LSB) | Default Value (Hex) | Default Notes/ Comments |
|------------------------------|------------------------|--|-----------|---|--------------------|--|--|--|---------------------------------|--|---|
| Chip Configuration Registers | | | | | | | | | | | |
| 0x00 | SPI port configuration | 0 | LSB first | Soft reset | 1 | 1 | Soft reset | LSB first | 0 | 0x18 | Nibbles are mirrored so that LSB-first mode or MSB-first mode is set correctly, regardless of shift mode. |
| 0x01 | Chip ID | 8-bit chip ID[7:0], AD9634 = 0x87 (default) | | | | | | | | 0x87 | Read only. |
| 0x02 | Chip grade | Open | Open | Speed grade ID; 00 = 250 MSPS 01 = 210 MSPS 11 = 170 MSPS | | Open | Open | Open | Open | | Speed grade ID used to differentiate devices; read only. |
| Transfer Register | | | | | | | | | | | |
| 0xFF | Transfer | Open | Open | Open | Open | Open | Open | Open | Transfer | 0x00 | Synchronously transfers data from the master shift register to the slave. |
| ADC Function Registers | | | | | | | | | | | |
| 0x08 | Power modes | Open | Open | Open | Open | Open | Open | Internal power-down mode 00 = normal operation 01 = full power-down 10 = standby 11 = reserved | | 0x00 | Determines various generic modes of chip operation. |
| 0x09 | Global clock | Open | Open | Open | Open | Open | Open | Open | Duty cycle stabilizer (default) | 0x01 | |
| 0x0B | Clock divide | Open | Open | Input clock divider phase adjust 000 = no delay 001 = 1 input clock cycle 010 = 2 input clock cycles 011 = 3 input clock cycles 100 = 4 input clock cycles 101 = 5 input clock cycles 110 = 6 input clock cycles 111 = 7 input clock cycles | | | Clock divide ratio 000 = divide by 1 001 = divide by 2 010 = divide by 3 011 = divide by 4 100 = divide by 5 101 = divide by 6 110 = divide by 7 111 = divide by 8 | | 0x00 | Clock divide values other than 000 automatically cause the duty cycle stabilizer to become active. | |
| 0x0D | Test mode | Test mode 0 = continuous/ repeat pattern 1 = single pattern then zeros | Open | Reset PN long gen | Reset PN short gen | Output test mode 0000 = off (default) 0001 = midscale short 0010 = positive FS 0011 = negative FS 0100 = alternating checkerboard 0101 = PN long sequence 0110 = PN short sequence 0111 = one/zero word toggle 1000 = user test mode 1001 to 1110 = unused 1111 = ramp output | | | | 0x00 | When this register is set, the test data is placed on the output pins in place of normal data. |

AD9634

| Addr (Hex) | Register Name | Bit 7 (MSB) | Bit 6 | Bit 5 | Bit 4 | Bit 3 | Bit 2 | Bit 1 | Bit 0 (LSB) | Default Value (Hex) | Default Notes/ Comments |
|------------|-------------------------|---------------------------|-------|--|--|---|---|--|-------------|---|--|
| 0x0E | BIST enable | Open | Open | Open | Open | Open | Reset BIST sequence | Open | BIST enable | 0x00 | |
| 0x10 | Offset adjust | Open | Open | Offset adjust in LSBs from +31 to -32 (twos complement format) | | | | | | 0x00 | |
| 0x14 | Output mode | Open | Open | Open | Output enable bar 0 = on (default) 1 = off | Open | Output invert 0 = normal (default) 1 = inverted | Output format 00 = offset binary (default) 01 = twos complement (default) 10 = gray code 11 = reserved | | 0x01 | Configures the outputs and the format of the data. |
| 0x15 | Output adjust | Open | Open | Open | Open | LVDS output drive current adjust 0000 = 3.72 mA output drive current 0001 = 3.5 mA output drive current (default) 0010 = 3.30 mA output drive current 0011 = 2.96 mA output drive current 0100 = 2.82 mA output drive current 0101 = 2.57 mA output drive current 0110 = 2.27 mA output drive current 0111 = 2.0 mA output drive current (reduced range) 1000 to 1111 = reserved | | | 0x01 | | |
| 0x16 | Clock phase control | Invert DCO clock | Open | Open | Open | Open | Open | Open | Open | 0x00 | |
| 0x17 | DCO output delay | Enable DCO clock delay | Open | Open | DCO clock delay [delay = (3100 ps × register value/31 + 100)] 00000 = 100 ps 00001 = 200 ps 00010 = 300 ps ... 11110 = 3100 ps 11111 = 3200 ps | | | | 0x00 | | |
| 0x18 | Input span select | Open | Open | Open | Full-scale input voltage selection 01111 = 2.087 V p-p ... 00001 = 1.772 V p-p 00000 = 1.75 V p-p (default) 11111 = 1.727 V p-p ... 10000 = 1.383 V p-p | | | | 0x00 | Full-scale input adjustment in 0.022 V steps. | |
| 0x19 | User Test Pattern 1 LSB | User Test Pattern 1[7:0] | | | | | | | | 0x00 | |
| 0x1A | User Test Pattern 1 MSB | User Test Pattern 1[15:8] | | | | | | | | 0x00 | |
| 0x1B | User Test Pattern 2 LSB | User Test Pattern 2[7:0] | | | | | | | | 0x00 | |
| 0x1C | User Test Pattern 2 MSB | User Test Pattern 2[15:8] | | | | | | | | 0x00 | |
| 0x1D | User Test Pattern 3 LSB | User Test Pattern 3[7:0] | | | | | | | | 0x00 | |
| 0x1E | User Test Pattern 3 MSB | User Test Pattern 3[15:8] | | | | | | | | 0x00 | |
| 0x1F | User Test Pattern 4 LSB | User Test Pattern 4[7:0] | | | | | | | | 0x00 | |
| 0x20 | User Test Pattern 4 MSB | User Test Pattern 4[15:8] | | | | | | | | 0x00 | |
| 0x24 | BIST signature LSB | BIST signature[7:0] | | | | | | | | 0x00 | Read only. |
| 0x25 | BIST signature MSB | BIST signature[15:8] | | | | | | | | 0x00 | Read only. |

APPLICATIONS INFORMATION

DESIGN GUIDELINES

Before starting system-level design and layout of the [AD9634](#), it is recommended that the designer become familiar with these guidelines, which describe the special circuit connections and layout requirements needed for certain pins.

Power and Ground Recommendations

When connecting power to the [AD9634](#), it is recommended that two separate 1.8 V supplies be used: use one supply for analog (AVDD) and a separate supply for digital outputs (DRVDD). The designer can employ several different decoupling capacitors to cover both high and low frequencies. Locate these capacitors close to the point of entry at the PC board level and close to the pins of the part with minimal trace length.

A single PCB ground plane should be sufficient when using the [AD9634](#). With proper decoupling and smart partitioning of the PCB analog, digital, and clock sections, optimum performance can be easily achieved.

Exposed Paddle Thermal Heat Slug Recommendations

It is mandatory that the exposed paddle on the underside of the ADC be connected to analog ground (AGND) to achieve the best electrical and thermal performance. A continuous, exposed (no solder mask) copper plane on the PCB should be connected to the [AD9634](#) exposed paddle, Pin 0.

The copper plane should have several vias to achieve the lowest possible resistive thermal path for heat dissipation to flow through the bottom of the PCB. These vias should be filled or plugged with nonconductive epoxy.

To maximize the coverage and adhesion between the ADC and the PCB, overlay a silkscreen to partition the continuous plane on the PCB into several uniform sections. This provides several tie points between the ADC and the PCB during the reflow process. Using one continuous plane with no partitions guarantees only one tie point between the ADC and the PCB. See the evaluation board for a PCB layout example. For detailed information about the packaging and PCB layout of chip scale packages, refer to the [AN-772 Application Note, A Design and Manufacturing Guide for the Lead Frame Chip Scale Package \(LFCSP\)](#).

VCM

Decouple the VCM pin to ground with a 0.1 μF capacitor, as shown in Figure 48.

SPI Port

The SPI port should not be active during periods when the full dynamic performance of the converter is required. Because the SCLK, CSB, and SDIO signals are typically asynchronous to the ADC clock, noise from these signals can degrade converter performance. If the on-board SPI bus is used for other devices, it may be necessary to provide buffers between this bus and the [AD9634](#) to keep these signals from transitioning at the converter input pins during critical sampling periods.

AD9634

OUTLINE DIMENSIONS

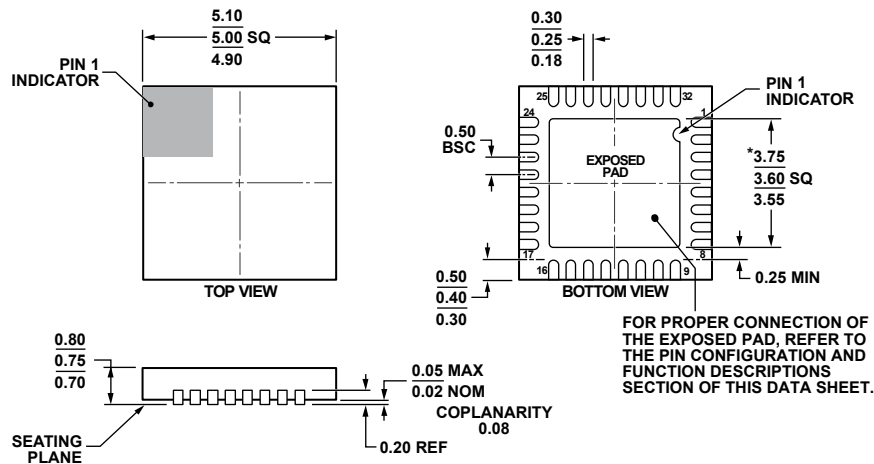

*COMPLIANT TO JEDEC STANDARDS MO-220-WHHD-5 WITH EXCEPTION TO EXPOSED PAD DIMENSION.

Figure 59. 32-Lead Lead Frame Chip Scale Package [LFCSP_WQ]
5 mm × 5 mm Body, Very Very Thin Quad
(CP-32-12)
Dimensions shown in millimeters

08-162010-B

ORDERING GUIDE

| Model ¹ | Temperature Range | Package Description | Package Option |
|--------------------|-------------------|--|----------------|
| AD9634BCPZ-250 | -40°C to +85°C | 32-Lead Lead Frame Chip Scale Package [LFCSP_WQ] | CP-32-12 |
| AD9634BCPZRL7-250 | -40°C to +85°C | 32-Lead Lead Frame Chip Scale Package [LFCSP_WQ] | CP-32-12 |
| AD9634BCPZ-210 | -40°C to +85°C | 32-Lead Lead Frame Chip Scale Package [LFCSP_WQ] | CP-32-12 |
| AD9634BCPZRL7-210 | -40°C to +85°C | 32-Lead Lead Frame Chip Scale Package [LFCSP_WQ] | CP-32-12 |
| AD9634BCPZ-170 | -40°C to +85°C | 32-Lead Lead Frame Chip Scale Package [LFCSP_WQ] | CP-32-12 |
| AD9634BCPZRL7-170 | -40°C to +85°C | 32-Lead Lead Frame Chip Scale Package [LFCSP_WQ] | CP-32-12 |
| AD9634-170EBZ | | Evaluation Board with AD9634 and Software | |
| AD9634-210EBZ | | Evaluation Board with AD9634 and Software | |
| AD9634-250EBZ | | Evaluation Board with AD9634 and Software | |

¹ Z = RoHS Compliant Part.

NOTES

AD9634

NOTES