

### Fully Sealed Relay with High Impulse Dielectric for Use in Telecommunications Equipment

- High sensitivity can be driven by digital circuits.
- Horizontal design allows use in 1/2-inch PCB racks.
- Impulse withstand voltage meets FCC Part 68 requirements.
- Relays can be mounted side-by-side due to low magnetic leakage.
- Single- and double-winding latching relays also available.
- Special models available for low thermoelectromotive force.

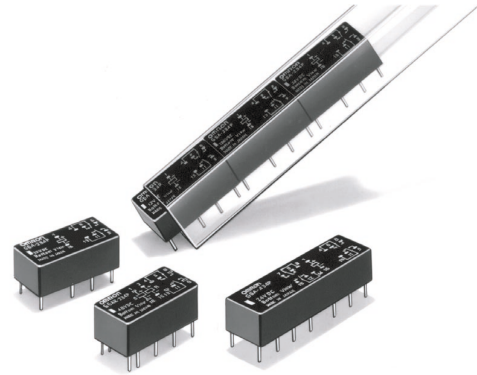

## Ordering Information

### Single-side Stable Type

Contact		Ag + Au-clad	AgPd + Au-clad
General purpose	DPDT	G6A-274P-ST-US	G6A-234P-ST-US
	4PDT	G6A-474P-ST-US	G6A-434P-ST-US
Low-sensitivity	DPDT	G6A-274P-ST40-US	G6A-234P-ST40-US
	4PDT	G6A-474P-ST40-US	G6A-434P-ST40-US

### Single-winding Latching Type

Contact		Ag + Au-clad	AgPd + Au-clad
General purpose	DPDT	G6AU-274P-ST-US	G6AU-234P-ST-US
	4PDT	G6AU-474P-ST-US	G6AU-434P-ST-US

### Double-winding Latching Type

Contact		Ag + Au-clad	AgPd + Au-clad
General purpose	DPDT	G6AK-274P-ST-US	G6AK-234P-ST-US
	4PDT	G6AK-474P-ST-US	G6AK-434P-ST-US
Low-sensitivity	DPDT	G6AK-274P-ST40-US	G6AK-234P-ST40-US
	4PDT	G6AK-474P-ST40-US	G6AK-434P-ST40-US

**Note:** When ordering, add the rated coil voltage to the model number.

Example: G6A-274P-ST-US 12 VDC

Rated coil voltage

### Model Number Legend

G6A  -     -   -   VDC  
 1 2 3 4 5 6 7 8 9

#### 1. Relay Function

None: Single-side stable  
 U: Single-winding latching  
 K: Double-winding latching

#### 2. Contact Form

2: DPDT  
 4: 4PDT

#### 3. Contact Type

7: Bifurcated crossbar  
 Ag (Au-clad) contact  
 3: Bifurcated crossbar  
 AgPd (Au-clad) contact

#### 4. Enclosure Ratings

4: Fully sealed

#### 5. Terminals

P: Straight PCB

#### 6. Stand-off

ST: Stand-off 0.64 mm

#### 7. Special Function

40: Low-sensitivity (400 mW)  
 LT: Low thermoelectromotive force

#### 8. Approved Standards

US: UL, CSA certified

#### 9. Rated Coil Voltage

3, 4.5, 5, 6, 9, 12, 24, 48 VDC

# Specifications

## ■ Coil Ratings

### General-purpose, DPDT Relays

Rated voltage		3 VDC	4.5 VDC	5 VDC	6 VDC	9 VDC	12 VDC	24 VDC	48 VDC	
Rated current		66.7 mA	44.6 mA	40 mA	33.3 mA	22.2 mA	16.7 mA	8.3 mA	4.9 mA	
Coil resistance		45 Ω	101 Ω	125 Ω	180 Ω	405 Ω	720 Ω	2,880 Ω	9,750 Ω	
Coil inductance (H) (ref. value)	Armature OFF	0.07	0.16	0.2	0.29	0.63	1.1	4.5	13.7	
	Armature ON	0.065	0.14	0.18	0.26	0.57	1.06	4.1	12.5	
Must operate voltage		70% max. of rated voltage								
Must release voltage		10% min. of rated voltage								
Max. voltage		200% of rated voltage at 23°C								
Power consumption		Approx. 200 mW						Approx. 235 mW		

### General-purpose, 4PDT Relays

Rated voltage		3 VDC	4.5 VDC	5 VDC	6 VDC	9 VDC	12 VDC	24 VDC	48 VDC
Rated current		120 mA	79.9 mA	72.5 mA	60 mA	40 mA	30 mA	15 mA	7.5 mA
Coil resistance		25 Ω	56.3 Ω	69 Ω	100 Ω	225 Ω	400 Ω	1,600 Ω	6,400 Ω
Coil inductance (H) (ref. value)	Armature OFF	0.05	0.11	0.14	0.2	0.45	0.8	3.2	12.8
	Armature ON	0.045	0.095	0.12	0.17	0.38	0.68	2.7	10.9
Must operate voltage		70% max. of rated voltage							
Must release voltage		10% min. of rated voltage							
Max. voltage		150% of rated voltage at 23°C							
Power consumption		Approx. 360 mW							

### Low-sensitivity DPDT Relays

Rated voltage		3 VDC	4.5 VDC	5 VDC	6 VDC	9 VDC	12 VDC	24 VDC	48 VDC
Rated current		133.3 mA	88.9 mA	80 mA	66.7 mA	44.3 mA	33.3 mA	16.7 mA	8.3 mA
Coil resistance		22.5 Ω	50.6 Ω	62.5 Ω	90 Ω	203 Ω	360 Ω	1,440 Ω	5,760 Ω
Coil inductance (H) (ref. value)	Armature OFF	0.03	0.065	0.08	0.11	0.27	0.52	2.1	7.5
	Armature ON	0.02	0.06	0.07	0.1	0.23	0.43	1.8	6.4
Must operate voltage		70% max. of rated voltage							
Must release voltage		10% min. of rated voltage							
Max. voltage		150% of rated voltage at 23°C							
Power consumption		Approx. 400 mW							

### Low-sensitivity 4PDT Relays

Rated voltage		3 VDC	4.5 VDC	5 VDC	6 VDC	9 VDC	12 VDC	24 VDC	48 VDC
Rated current		133.3 mA	88.9 mA	80 mA	66.7 mA	44.3 mA	33.3 mA	16.7 mA	8.3 mA
Coil resistance		22.5 Ω	50.6 Ω	62.5 Ω	90 Ω	203 Ω	360 Ω	1,440 Ω	5,760 Ω
Coil inductance (H) (ref. value)	Armature OFF	0.035	0.1	0.12	0.17	0.42	0.7	2.8	10.2
	Armature ON	0.02	0.07	0.09	0.13	0.3	0.52	2.2	8.6
Must operate voltage		70% max. of rated voltage							
Must release voltage		10% min. of rated voltage							
Max. voltage		150% of rated voltage at 23°C							
Power consumption		Approx. 400 mW							

## Single-winding Latching, DPDT Relays

Rated voltage	3 VDC	4.5 VDC	5 VDC	6 VDC	9 VDC	12 VDC	24 VDC	48 VDC	
Rated current	33.7 mA	22.2 mA	20 mA	16.7 mA	11.1 mA	8.3 mA	4.2 mA	2.5 mA	
Coil resistance	89 $\Omega$	202 $\Omega$	250 $\Omega$	360 $\Omega$	810 $\Omega$	1,440 $\Omega$	5,760 $\Omega$	19,000 $\Omega$	
Coil inductance (H) (ref. value)	Armature OFF	0.15	0.34	0.44	0.64	1.38	2.5	28.5	
	Armature ON	0.11	0.25	0.35	0.48	1.07	2	22	
Must operate voltage	70% max. of rated voltage								
Must release voltage	70% max. of rated voltage								
Max. voltage	200% of rated voltage at 23°C								
Power consumption	Approx. 100 mW							Approx. 120 mW	

## Single-winding Latching, 4PDT Relays

Rated voltage	3 VDC	4.5 VDC	5 VDC	6 VDC	9 VDC	12 VDC	24 VDC	48 VDC
Rated current	106.8 mA	71.2 mA	64 mA	53.3 mA	35.6 mA	26.7 mA	13.3 mA	6.7 mA
Coil resistance	28.1 $\Omega$	63.2 $\Omega$	78.1 $\Omega$	112.5 $\Omega$	253 $\Omega$	450 $\Omega$	1,800 $\Omega$	7,200 $\Omega$
Coil inductance (H) (ref. value)	Armature OFF	0.03	0.06	0.08	0.11	0.25	0.45	1.8
	Armature ON	0.02	0.04	0.06	0.08	0.18	0.32	1.3
Must operate voltage	70% max. of rated voltage							
Must release voltage	70% max. of rated voltage							
Max. voltage	150% of rated voltage at 23°C							
Power consumption	Approx. 320 mW							

## Double-winding Latching, DPDT Relays

Rated voltage	3 VDC	4.5 VDC	5 VDC	6 VDC	9 VDC	12 VDC	24 VDC	48 VDC	
Rated current	66.7 mA	40.2 mA	36 mA	30 mA	20 mA	15 mA	7.5 mA	4.2 mA	
Coil resistance	45 $\Omega$	112 $\Omega$	139 $\Omega$	200 $\Omega$	450 $\Omega$	800 $\Omega$	3,200 $\Omega$	11,520 $\Omega$	
Coil inductance (H) (ref. value)	Set	Armature OFF	0.037	0.09	0.11	0.16	0.38	0.6	2.1
		Armature ON	0.027	0.065	0.08	0.12	0.28	0.45	1.5
	Reset	Armature OFF	0.027	0.065	0.08	0.12	0.28	0.45	1.5
		Armature ON	0.037	0.09	0.11	0.16	0.38	0.6	2.1
Must operate voltage	70% max. of rated voltage								
Must release voltage	70% max. of rated voltage								
Max. voltage	200% of rated voltage at 23°C								
Power consumption	Approx. 200 mW		Approx. 180 mW					Approx. 200 mW	

## Double-winding Latching, 4PDT Relays

Rated voltage	3 VDC	4.5 VDC	5 VDC	6 VDC	9 VDC	12 VDC	24 VDC	48 VDC	
Rated current	106.8 mA	71.2 mA	64 mA	53.3 mA	35.6 mA	26.7 mA	13.3 mA	6.7 mA	
Coil resistance	28.1 $\Omega$	63.2 $\Omega$	78.1 $\Omega$	112.5 $\Omega$	253 $\Omega$	450 $\Omega$	1,800 $\Omega$	7,200 $\Omega$	
Coil inductance (H) (ref. value)	Set	Armature OFF	0.03	0.06	0.08	0.11	0.25	0.45	1.8
		Armature ON	0.02	0.04	0.06	0.08	0.18	0.32	1.3
	Reset	Armature OFF	0.02	0.04	0.06	0.08	0.18	0.32	1.3
		Armature ON	0.03	0.06	0.08	0.11	0.25	0.45	1.8
Must operate voltage	70% max. of rated voltage								
Must release voltage	70% max. of rated voltage								
Max. voltage	150% of rated voltage at 23°C								
Power consumption	Approx. 320 mW								

### Double-winding Latching, Low-sensitivity DPDT Relays

Rated voltage		3 VDC	4.5 VDC	5 VDC	6 VDC	9 VDC	12 VDC	24 VDC	48 VDC	
Rated current		120 mA	79.9 mA	72.5 mA	60 mA	40 mA	30 mA	15 mA	7.5 mA	
Coil resistance		25 Ω	56.3 Ω	69 Ω	100 Ω	225 Ω	400 Ω	1,600 Ω	6,400 Ω	
Coil inductance (H) (ref. value)	Set	Armature OFF	0.015	0.04	0.05	0.07	0.16	0.28	1.1	4
		Armature ON	0.01	0.025	0.035	0.05	0.12	0.2	0.75	2.9
	Reset	Armature OFF	0.01	0.025	0.035	0.05	0.12	0.2	0.75	2.9
		Armature ON	0.015	0.04	0.05	0.07	0.16	0.28	1.1	4
Must operate voltage		70% max. of rated voltage								
Must release voltage		70% max. of rated voltage								
Max. voltage		150% of rated voltage at 23°C								
Power consumption		Approx. 360 mW								

### Double-winding Latching, Low-sensitivity 4PDT Relays

Rated voltage		3 VDC	4.5 VDC	5 VDC	6 VDC	9 VDC	12 VDC	24 VDC	48 VDC	
Rated current		120 mA	79.9 mA	72.5 mA	60 mA	40 mA	30 mA	15 mA	7.5 mA	
Coil resistance		25 Ω	56.3 Ω	69 Ω	100 Ω	225 Ω	400 Ω	1,600 Ω	6,400 Ω	
Coil inductance (H) (ref. value)	Set	Armature OFF	0.02	0.045	0.065	0.09	0.18	0.3	1.2	4.4
		Armature ON	0.015	0.035	0.05	0.075	0.14	0.23	0.82	3.2
	Reset	Armature OFF	0.015	0.035	0.05	0.075	0.14	0.23	0.82	3.2
		Armature ON	0.02	0.045	0.065	0.09	0.18	0.3	1.2	4.4
Must operate voltage		70% max. of rated voltage								
Must release voltage		70% max. of rated voltage								
Max. voltage		150% of rated voltage at 23°C								
Power consumption		Approx. 360 mW								

- Note:**
- The rated current and coil resistance are measured at a coil temperature of 23°C with a tolerance of ±10%.
  - Operating characteristics are measured at a coil temperature of 23°C.

### ■ Contact Ratings

Item	G6A-234P-ST(40)-US/434P-ST(40)-US		G6A-274P-ST(40)-US/474P-ST(40)-US	
Load	Resistive load ( $\cos\phi = 1$ )	Inductive load ( $\cos\phi = 0.4$ ; L/R = 7 ms)	Resistive load ( $\cos\phi = 1$ )	Inductive load ( $\cos\phi = 0.4$ ; L/R = 7 ms)
Rated load	0.3 A at 125 VAC; 1 A at 30 VDC	0.2 A at 125 VAC; 0.5 A at 30 VDC	0.5 A at 125 VAC; 2 A at 30 VDC	0.3 A at 125 VAC; 1 A at 30 VDC
Contact material	AgPd (Au-clad)		Ag (Au-clad)	
Rated carry current	3 A			
Max. switching voltage	250 VAC, 220 VDC			
Max. switching current	2 A	1 A	2 A	1 A
Max. switching power	125 VA, 60 W	62.5 VA, 30 W	125 VA, 60 W	62.5 VA, 30 W
Failure rate (reference value)	0.01 mA at 10 mVDC			

Item	G6AK-234P-ST(40)-US/G6AK-434P-ST(40)-US G6AU-234P-ST-US/G6AU-434P-ST-US		G6AK-274P-ST(40)-US/G6AK-474P-ST(40)-US G6AU-274P-ST-US/G6AU-474P-ST-US	
Load	Resistive load ( $\cos\phi = 1$ )	Inductive load ( $\cos\phi = 0.4$ ; L/R = 7 ms)	Resistive load ( $\cos\phi = 1$ )	Inductive load ( $\cos\phi = 0.4$ ; L/R = 7 ms)
Rated load	0.3 A at 125 VAC; 1 A at 30 VDC	0.2 A at 125 VAC; 0.5 A at 30 VDC	0.5 A at 125 VAC; 2 A at 30 VDC	0.25 A at 125 VAC; 1 A at 30 VDC
Contact material	AgPd (Au-clad)		Ag (Au-clad)	
Rated carry current	3 A			
Max. switching voltage	250 VAC, 220 VDC			
Max. switching current	2 A	1 A	2 A	1 A
Max. switching power	125 VA, 60 W	62.5 VA, 30 W	125 VA, 60 W	62.5 VA, 30 W
Failure rate (reference value)	0.01 mA at 10 mVDC			

**Note** P level:  $\lambda_{60} = 0.1 \times 10^{-6}$ /operation

## ■ Characteristics

<b>Contact resistance</b>	50 mΩ max.
<b>Operate (set) time</b>	Single-side stable types: DPDT: 5 ms max. (mean value: approx. 3 ms) 4PDT: 7 ms max. (mean value: approx. 3.8 ms) Latching types: DPDT: 5 ms max. (mean value: approx. 2.5 ms) 4PDT: 7 ms max. (mean value: approx. 3.3 ms)
<b>Release (reset) time</b>	Single-side stable types: DPDT: 3 ms max. (mean value: approx. 1.2 ms) 4PDT: 5 ms max. (mean value: approx. 1.3 ms) Latching types: DPDT: 5 ms max. (mean value: approx. 2.5 ms) 4PDT: 7 ms max. (mean value: approx. 2.7 ms)
<b>Bounce time</b>	Operate: mean value: approx. 0.5 ms Release: mean value: approx. 0.5 ms
<b>Min. set/reset signal width</b>	DPDT: 7 ms min. 4PDT: 15 ms min.
<b>Max. operating frequency</b>	Mechanical: 36,000 operations/hr Electrical: 1,800 operations/hr (under rated load)
<b>Insulation resistance</b>	1,000 MΩ min. (at 500 VDC); except for set-reset
<b>Dielectric strength</b>	1,000 VAC, 50/60 Hz for 1 min between coil and contacts 1,000 VAC, 50/60 Hz for 1 min between contacts of different polarity 1,000 VAC, 50/60 Hz for 1 min between contacts of same polarity 250 VAC, 50/60 Hz for 1 min between set and reset coils
<b>Impulse withstand voltage</b>	1,500 V (10 x 160 μs) (conforms to FCC Part 68)
<b>Vibration resistance</b>	Destruction: 10 to 55 to 10 Hz, 2.5-mm single amplitude (5-mm double amplitude) Malfunction: 10 to 55 to 10 Hz, 1.65-mm single amplitude (3.3-mm double amplitude)
<b>Shock resistance</b>	Destruction: 1,000 m/s <sup>2</sup> (approx. 100G) Malfunction: DPDT: 500 m/s <sup>2</sup> (approx. 50G) 4PDT, Latching type: 300 m/s <sup>2</sup> (approx. 30G)
<b>Endurance</b>	Mechanical: 100,000,000 operations min. (at 36,000 operations/hr) Electrical: 500,000 operations min. (at 1,800 operations/hr)
<b>Ambient temperature</b>	Operating: -40°C to 70°C (with no icing)
<b>Ambient humidity</b>	Operating: 5% to 85%
<b>Weight</b>	DPDT: Approx. 3.5 g 4PDT: Approx. 6 g

**Note** The data shown above are initial values.

## ■ Approved Standards

UL114, UL478 (File No. E41515)/CSA C22.2 No.0, No.14 (File No. LR24825)

Model	Contact form	Coil ratings	Contact ratings
G6A-234P-ST(40)-US G6AK-234P-ST(40)-US G6AU-234P-ST-US	DPDT	3 to 48 VDC	0.6 A, 125 VAC 1 A, 30 VDC 0.6 A, 110 VDC
G6A-274P-ST(40)-US G6AK-274P-ST(40)-US G6AU-274P-ST-US	DPDT		0.6 A, 125 VAC 2 A, 30 VDC 0.6 A, 110 VDC
G6A-434P-ST(40)-US G6AK-434P-ST(40)-US G6AU-434P-ST-US	4PDT		0.6 A, 125 VAC 1 A, 30 VDC 0.6 A, 110 VDC
G6A-474P-ST(40)-US G6AK-474P-ST(40)-US G6AU-474P-ST-US	4PDT		0.6 A, 125 VAC 2 A, 30 VDC 0.6 A, 110 VDC

# Engineering Data

**Maximum Switching Power  
DPDT, 4PDT**

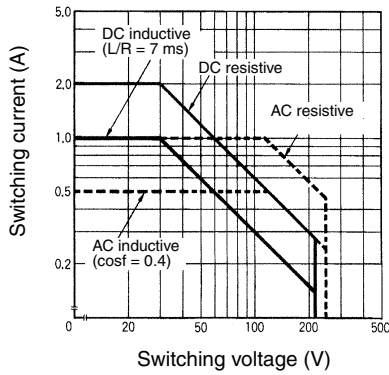

**Ambient Temperature vs.  
Maximum Coil Voltage**

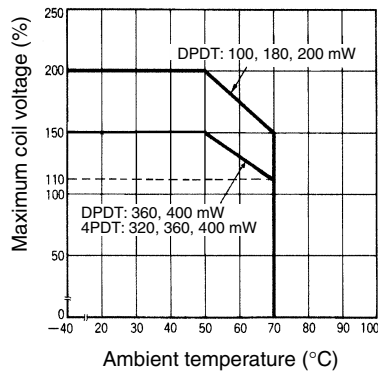

**Note:** The maximum coil voltage refers to the maximum value in a varying range of operating power voltage, not a continuous voltage.

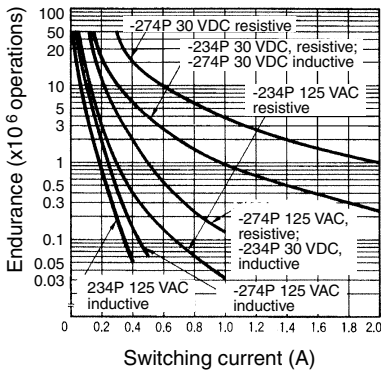

**Endurance  
DPDT**

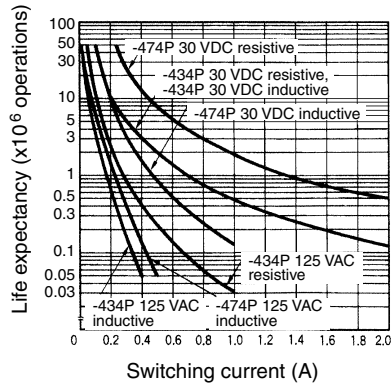

**4PDT**



## Dimensions

- Note:** 1. All units are in millimeters unless otherwise indicated.  
2. Orientation marks are indicated as follows:  

### G6A-234P-ST(40)-US, G6A-274P-ST(40)-US

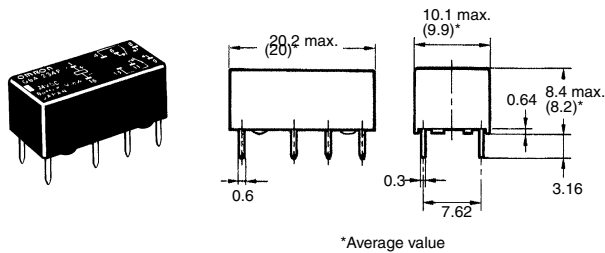

#### Terminal Arrangement/ Internal Connections (Bottom View)

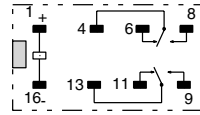

#### Mounting Holes (Bottom View) Tolerance: $\pm 0.1$

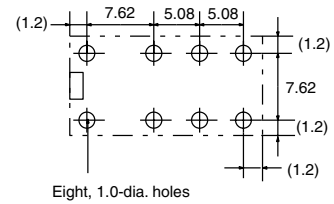

### G6A-434P-ST(40)-US, G6A-474P-ST-US

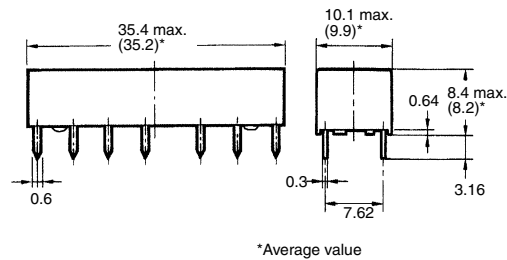
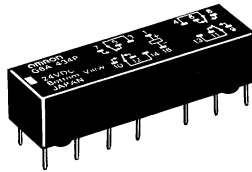

#### Terminal Arrangement/ Internal Connections (Bottom View)

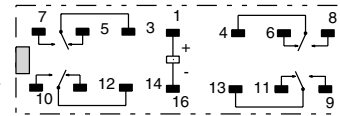

#### Mounting Holes (Bottom View) Tolerance: $\pm 0.1$

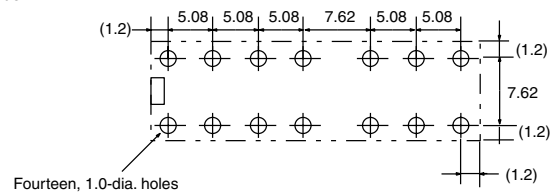

### G6AK-234P-ST(40)-US, G6AK-274P-ST(40)-US

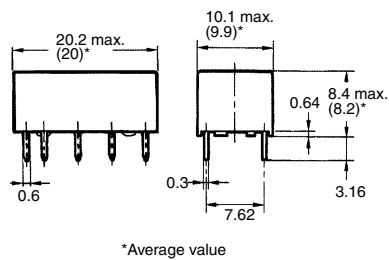
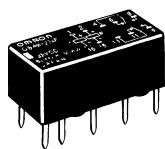

#### Terminal Arrangement/ Internal Connections (Bottom View)

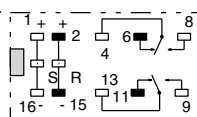

#### Mounting Holes (Bottom View) Tolerance: $\pm 0.1$

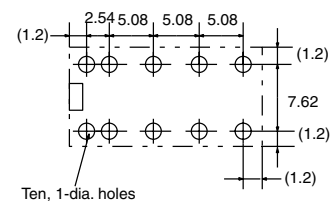

**G6AK-434P-ST(40)-US,  
G6AK-474P-ST(40)-US**

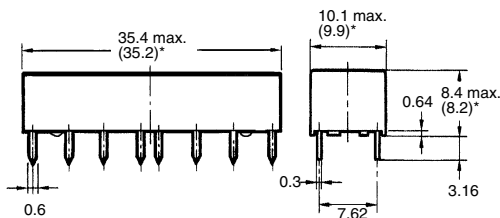
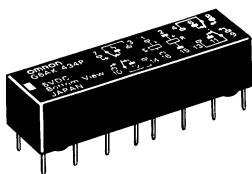

\*Average value

**Terminal Arrangement/  
Internal Connections  
(Bottom View)**

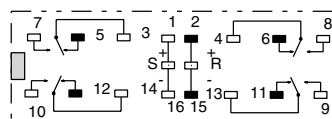

**Mounting Holes  
(Bottom View)**

Tolerance:  $\pm 0.1$

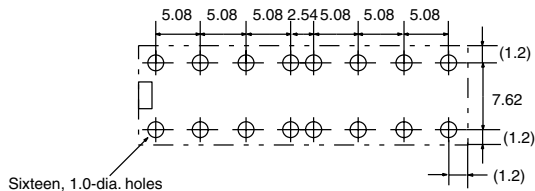

**G6AU-234P-ST-US,  
G6AU-274P-ST-US**

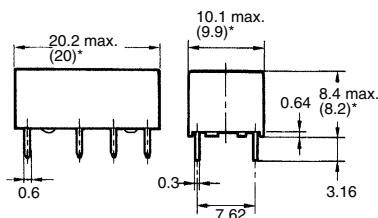
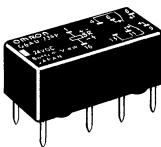

\*Average value

**Terminal Arrangement/  
Internal Connections  
(Bottom View)**

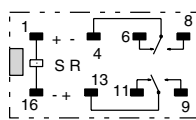

**Mounting Holes  
(Bottom View)**

Tolerance:  $\pm 0.1$

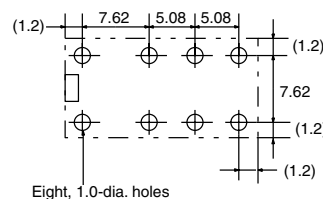

**G6AU-434P-US,  
G6AU-474P-ST-US**

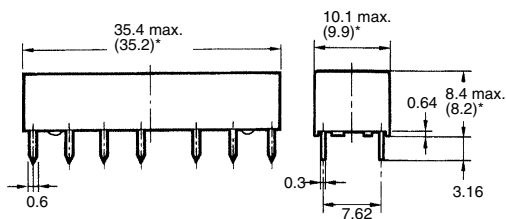
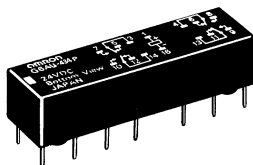

\*Average value

**Terminal Arrangement/  
Internal Connections  
(Bottom View)**

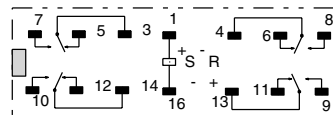

**Mounting Holes  
(Bottom View)**

Tolerance:  $\pm 0.1$

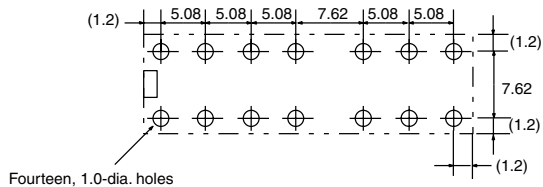

**ALL DIMENSIONS SHOWN ARE IN MILLIMETERS.**  
To convert millimeters into inches, multiply by 0.03937. To convert grams into ounces, multiply by 0.03527.