



# RF Power LDMOS Transistors

## High Ruggedness N-Channel Enhancement-Mode Lateral MOSFETs

Optimized for broadband operation from 470 to 860 MHz. Device has an integrated input matching network for better power distribution. These devices are ideally suited for use in analog or digital television transmitters.

- Typical Narrowband Performance:  $V_{DD} = 50$  Volts,  $I_{DQ} = 1400$  mA, Channel Bandwidth = 8 MHz, Input Signal PAR = 9.5 dB @ 0.01% Probability on CCDF. ACPR measured in 7.61 MHz Signal Bandwidth @  $\pm 4$  MHz Offset with an Integration Bandwidth of 4 kHz.

Signal Type	$P_{out}$ (W)	f (MHz)	$G_{ps}$ (dB)	$\eta_D$ (%)	ACPR (dBc)	IRL (dB)
DVB-T (8k OFDM)	125 Avg.	860	19.3	30.0	-60.5	-12

- Typical Pulsed Broadband Performance:  $V_{DD} = 50$  Volts,  $I_{DQ} = 1400$  mA, Pulsed Width = 100  $\mu$ sec, Duty Cycle = 10%

Signal Type	$P_{out}$ (W)	f (MHz)	$G_{ps}$ (dB)	$\eta_D$ (%)
Pulsed	600 Peak	470	19.3	47.1
		650	20.0	53.1
		860	18.8	48.9

### Features

- Capable of Handling >65:1 VSWR through all Phase Angles @ 50 Vdc, 860 MHz, DVB-T (8k OFDM) 240 Watts Avg. Output Power (3 dB Input Overdrive from Rated  $P_{out}$ )
- Exceptional Efficiency for Class AB Analog or Digital Television Operation
- Full Performance across Complete UHF TV Spectrum, 470-860 MHz
- Capable of 600 Watt CW Output Power with Adequate Thermal Management
- Integrated Input Matching
- Extended Negative Gate-Source Voltage Range of -6.0 V to +10 V
  - Improves Class C Performance, e.g. in a Doherty Peaking Stage
  - Enables Fast, Easy and Complete Shutdown of the Amplifier
- Characterized from 20 V to 50 V for Extended Operating Range for use with Drain Modulation
- Excellent Thermal Characteristics
- RoHS Compliant
- In Tape and Reel. R6 Suffix = 150 Units, 56 mm Tape Width, 13 inch Reel. R5 Suffix = 50 Units, 56 mm Tape Width, 13 inch Reel.

Table 1. Maximum Ratings

Rating	Symbol	Value	Unit
Drain-Source Voltage	$V_{DSS}$	-0.5, +130	Vdc
Gate-Source Voltage	$V_{GS}$	-6.0, +10	Vdc
Storage Temperature Range	$T_{stg}$	-65 to +150	$^{\circ}$ C
Case Operating Temperature	$T_C$	150	$^{\circ}$ C
Total Device Dissipation @ $T_C = 25^{\circ}$ C Derate above 25 $^{\circ}$ C	$P_D$	1052 5.26	W W/ $^{\circ}$ C
Operating Junction Temperature (1,2)	$T_J$	225	$^{\circ}$ C

1. Continuous use at maximum temperature will affect MTTF.
2. MTTF calculator available at <http://www.freescale.com/rf>. Select Software & Tools/Development Tools/Calculators to access MTTF calculators by product.

**MRFE6VP8600HR6**  
**MRFE6VP8600HR5**  
**MRFE6VP8600HSR6**  
**MRFE6VP8600HSR5**

**470-860 MHz, 600 W, 50 V**  
**LDMOS BROADBAND**  
**RF POWER TRANSISTORS**

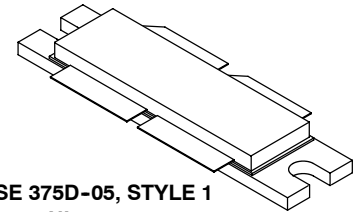

**CASE 375D-05, STYLE 1**  
**NI-1230**  
**MRFE6VP8600HR6**

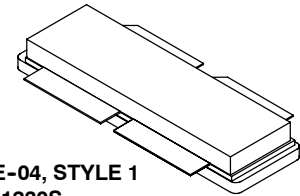

**CASE 375E-04, STYLE 1**  
**NI-1230S**  
**MRFE6VP8600HSR6**

**PARTS ARE PUSH-PULL**

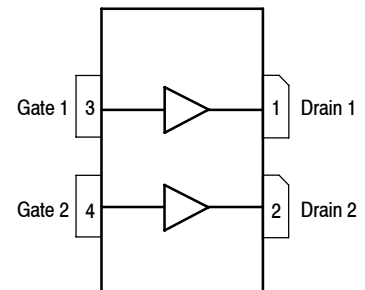

(Top View)

Note: The backside of the package is the source terminal for the transistor.

**Figure 1. Pin Connections**

**Table 2. Thermal Characteristics**

Characteristic	Symbol	Value (1,2)	Unit
Thermal Resistance, Junction to Case Case Temperature 74°C, 125 W CW, 50 V, 1400 mA, 860 MHz	$R_{\theta JC}$	0.19 (3)	°C/W

**Table 3. ESD Protection Characteristics**

Test Methodology	Class
Human Body Model (per JESD22-A114)	2 (2001-4000 V)
Machine Model (per EIA/JESD22-A115)	B (201-400 V)
Charge Device Model (per JESD22-C101)	IV (>1000 V)

**Table 4. Electrical Characteristics** ( $T_A = 25^\circ\text{C}$  unless otherwise noted)

Characteristic	Symbol	Min	Typ	Max	Unit
----------------	--------	-----	-----	-----	------

**Off Characteristics (4)**

Gate-Source Leakage Current ( $V_{GS} = 5\text{ Vdc}$ , $V_{DS} = 0\text{ Vdc}$ )	$I_{GSS}$	—	—	1	$\mu\text{Adc}$
Drain-Source Breakdown Voltage ( $V_{GS} = 0\text{ Vdc}$ , $I_D = 100\text{ mA}$ )	$V_{(BR)DSS}$	130	140	—	Vdc
Zero Gate Voltage Drain Leakage Current ( $V_{DS} = 50\text{ Vdc}$ , $V_{GS} = 0\text{ Vdc}$ )	$I_{DSS}$	—	—	5	$\mu\text{Adc}$
Zero Gate Voltage Drain Leakage Current ( $V_{DS} = 100\text{ Vdc}$ , $V_{GS} = 0\text{ Vdc}$ )	$I_{DSS}$	—	—	20	$\mu\text{Adc}$

**On Characteristics**

Gate Threshold Voltage (4) ( $V_{DS} = 10\text{ Vdc}$ , $I_D = 980\ \mu\text{Adc}$ )	$V_{GS(th)}$	1.5	2.07	2.5	Vdc
Gate Quiescent Voltage (5) ( $V_{DD} = 50\text{ Vdc}$ , $I_D = 1400\text{ mAdc}$ , Measured in Functional Test)	$V_{GS(Q)}$	2.1	2.65	3.1	Vdc
Drain-Source On-Voltage (4) ( $V_{GS} = 10\text{ Vdc}$ , $I_D = 2\text{ Adc}$ )	$V_{DS(on)}$	—	0.24	—	Vdc
Forward Transconductance ( $V_{DS} = 10\text{ Vdc}$ , $I_D = 20\text{ Adc}$ )	$g_{fs}$	—	15.6	—	S

**Dynamic Characteristics (4)**

Reverse Transfer Capacitance (6) ( $V_{DS} = 50\text{ Vdc} \pm 30\text{ mV(rms)ac}$ @ 1 MHz, $V_{GS} = 0\text{ Vdc}$ )	$C_{rss}$	—	1.49	—	pF
Output Capacitance (6) ( $V_{DS} = 50\text{ Vdc} \pm 30\text{ mV(rms)ac}$ @ 1 MHz, $V_{GS} = 0\text{ Vdc}$ )	$C_{oss}$	—	79.9	—	pF
Input Capacitance (7) ( $V_{DS} = 50\text{ Vdc}$ , $V_{GS} = 0\text{ Vdc} \pm 30\text{ mV(rms)ac}$ @ 1 MHz)	$C_{iss}$	—	264	—	pF

**Functional Tests (5)** (In Freescale Narrowband Test Fixture, 50 ohm system)  $V_{DD} = 50\text{ Vdc}$ ,  $I_{DQ} = 1400\text{ mA}$ ,  $P_{out} = 125\text{ W Avg.}$ ,  $f = 860\text{ MHz}$ , DVB-T (8k OFDM) Single Channel. ACPR measured in 7.61 MHz Signal Bandwidth @  $\pm 4\text{ MHz}$  Offset with an Integration Bandwidth of 4 kHz.

Power Gain	$G_{ps}$	18.0	19.3	21.0	dB
Drain Efficiency	$\eta_D$	29.0	30.0	—	%
Adjacent Channel Power Ratio	ACPR	—	-60.5	-58.5	dBc
Input Return Loss	IRL	—	-12	-9	dB

1. MTTF calculator available at <http://www.freescale.com/rf>. Select Software & Tools/Development Tools/Calculators to access MTTF calculators by product.
2. Refer to AN1955, *Thermal Measurement Methodology of RF Power Amplifiers*. Go to <http://www.freescale.com/rf>. Select Documentation/Application Notes - AN1955.
3. Performance with thermal grease TIM (thermal interface material) will typically degrade by  $0.05^\circ\text{C/W}$  due to the increased thermal contact resistance of this TIM.
4. Each side of device measured separately.
5. Measurement made with device in push-pull configuration.
6. Part internally input matched.
7. Die capacitance value without internal matching.

(continued)

**MRFE6VP8600HR6 MRFE6VP8600HR5 MRFE6VP8600HSR6 MRFE6VP8600HSR5**RF Device Data  
Freescale Semiconductor

**Table 4. Electrical Characteristics** ( $T_A = 25^\circ\text{C}$  unless otherwise noted) (continued)

Characteristic	Symbol	Min	Typ	Max	Unit
<b>Typical DVB-T (8k OFDM) Performance</b> (In Freescale Narrowband Test Fixture, 50 ohm system) $V_{DD} = 50$ Vdc, $I_{DQ} = 1400$ mA, $f = 860$ MHz, DVB-T (8k OFDM) Single Channel.					
Output Peak-to-Average Ratio @ 0.01% Probability on CCDF, $P_{out} = 125$ W Avg.	PAR	—	7.8	—	dB
Load Mismatch VSWR >65:1 at all Phase Angles, 3 dB Overdrive from Rated $P_{out}$ (240 W Avg.)	$\Psi$	No Degradation in Output Power			

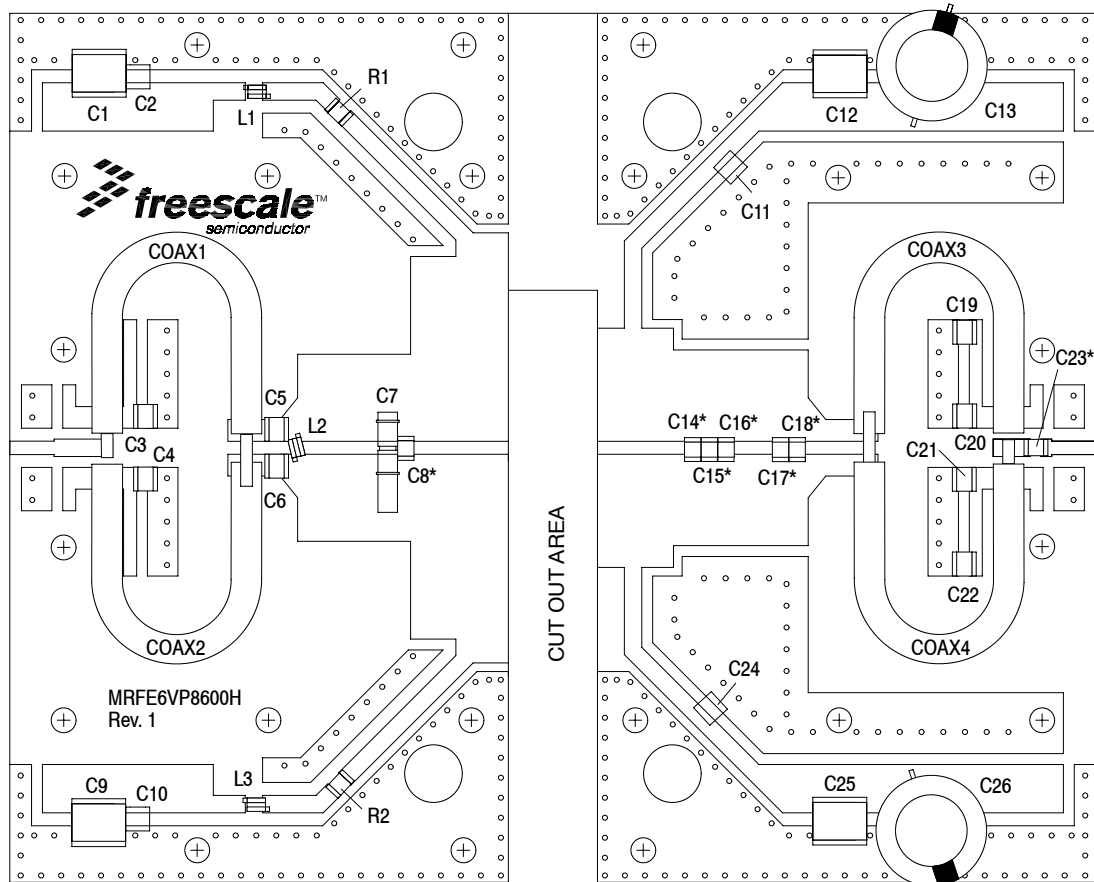

\*C8, C14, C15, C16, C17, C18 and C23 are mounted vertically.

Figure 2. MRFE6VP8600HR6(HSR6) Test Circuit Component Layout — 860 MHz, DVB-T (8k OFDM)

Table 5. MRFE6VP8600HR6(HSR6) Test Circuit Component Designations and Values — 860 MHz, DVB-T (8k OFDM)

Part	Description	Part Number	Manufacturer
C1, C9	10 $\mu$ F, 50 V, Chip Capacitors	GRM55DR61H106KA88L	Murata
C2, C10	2.2 $\mu$ F, 50 V, Chip Capacitors	C3225X7R1H225K	TDK
C3, C4, C20, C21, C23	100 pF Chip Capacitors	ATC100B101JT500XT	ATC
C5, C6	24 pF Chip Capacitors	ATC100B240JT500XT	ATC
C7	0.8–8.0 pF Variable Capacitor	27291SL	Johanson Components
C8	12 pF Chip Capacitor	ATC100B120JT500XT	ATC
C11, C24	2.2 $\mu$ F, 100 V, Chip Capacitors	C3225X7R2A225KT	TDK
C12, C25	4.7 $\mu$ F, 100 V, Chip Capacitors	GRM55ER72A475KA01B	Murata
C13, C26	470 $\mu$ F, 63 V Electrolytic Capacitors	MCGPR63V477M13X26-RH	Multicomp
C14	6.8 pF Chip Capacitor	ATC100B6R8CT500XT	ATC
C15	3.0 pF Chip Capacitor	ATC100B3R0CT500XT	ATC
C16	2.7 pF Chip Capacitor	ATC100B2R7BT500XT	ATC
C17	3.9 pF Chip Capacitor	ATC100B3R9CT500XT	ATC
C18	5.1 pF Chip Capacitor	ATC100B5R1CT500XT	ATC
C19, C22	1000 pF Chip Capacitors	ATC100B102JT50XT	ATC
Coax1, 2, 3, 4	25 $\Omega$ SemiRigid Coax, Length 2.0"	UT-141C-25	Micro-Coax
L1, L3	5.0 nH, 2 Turn Inductors	A02TKLC	Coilcraft
L2	2.5 nH, 1 Turn Inductor	A01TKLC	Coilcraft
R1, R2	10 $\Omega$ , 1/4 W Chip Resistors	CRCW120610R0JNEA	Vishay
PCB	0.030", $\epsilon_r = 3.5$	RO4350B	Rogers

MRFE6VP8600HR6 MRFE6VP8600HR5 MRFE6VP8600HSR6 MRFE6VP8600HSR5

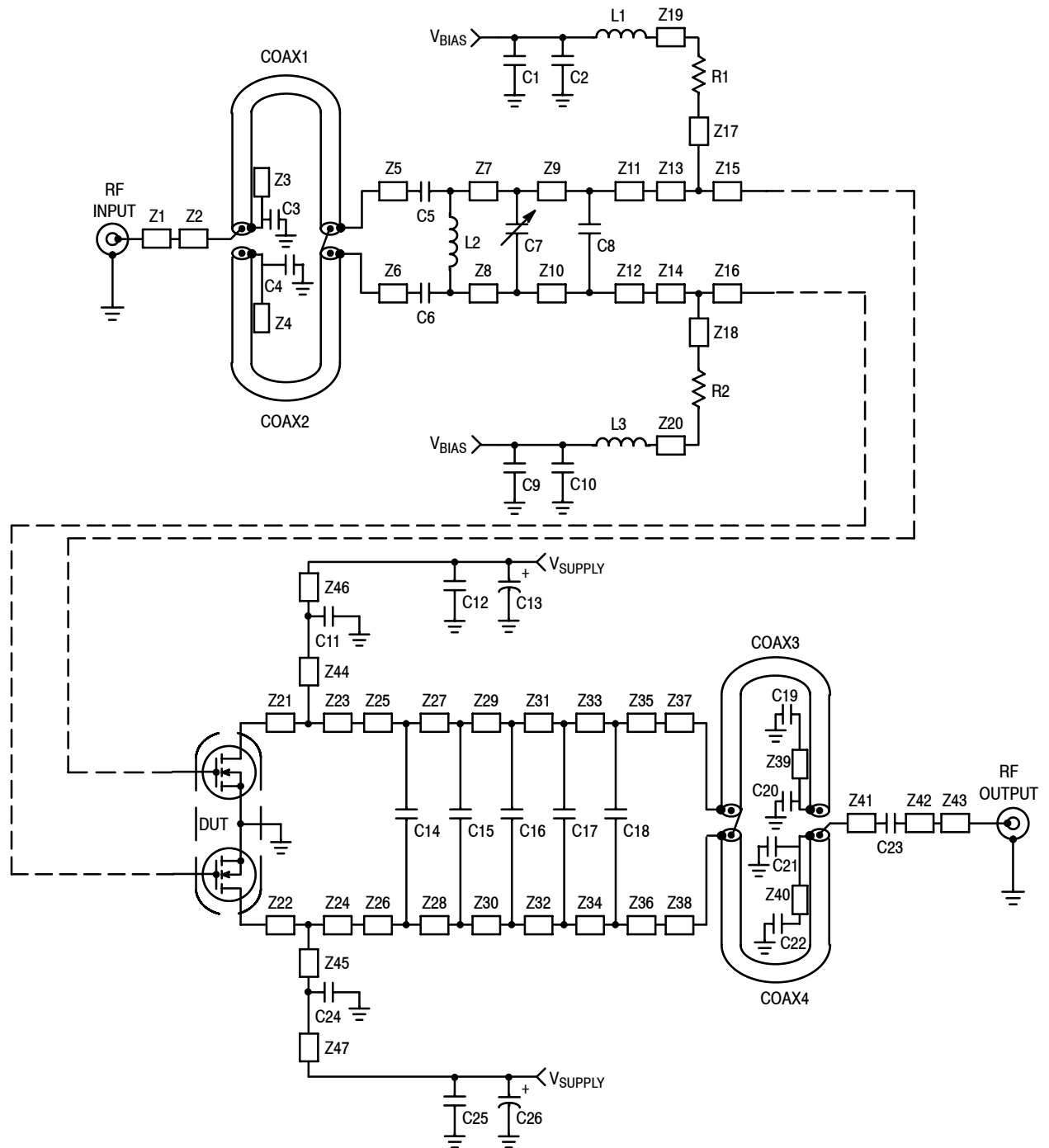

Z1	0.204" x 0.062" Microstrip	Z17, Z18	0.780" x 0.080" Microstrip	Z35, Z36	0.052" x 0.420" Microstrip
Z2	0.245" x 0.080" Microstrip	Z19*, Z20*	0.354" x 0.080" Microstrip	Z37, Z38	0.211" x 0.100" Microstrip
Z3, Z4	0.445" x 0.060" Microstrip	Z21, Z22	0.164" x 0.520" Microstrip	Z39, Z40	0.389" x 0.060" Microstrip
Z5, Z6	0.019" x 0.100" Microstrip	Z23, Z24	0.186" x 0.520" Microstrip	Z41	0.070" x 0.080" Microstrip
Z7, Z8	0.415" x 0.400" Microstrip	Z25, Z26	0.088" x 0.420" Microstrip	Z42	0.018" x 0.080" Microstrip
Z9, Z10	0.083" x 0.400" Microstrip	Z27, Z28	0.072" x 0.420" Microstrip	Z43	0.204" x 0.062" Microstrip
Z11, Z12	0.022" x 0.400" Microstrip	Z29, Z30	0.072" x 0.420" Microstrip	Z44*, Z45*	0.850" x 0.080" Microstrip
Z13, Z14	0.208" x 0.850" Microstrip	Z31, Z32	0.259" x 0.420" Microstrip	Z46, Z47	0.250" x 0.080" Microstrip
Z15, Z16	0.242" x 0.960" Microstrip	Z33, Z34	0.075" x 0.420" Microstrip		

\* Line length includes microstrip bends

**Figure 3. MRFE6VP8600HR6(HSR6) Test Circuit Schematic — 860 MHz, DVB-T (8k OFDM)**

TYPICAL CHARACTERISTICS — 860 MHz

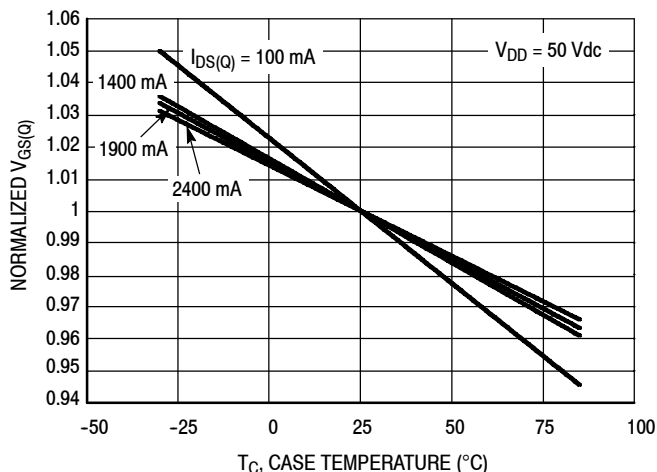
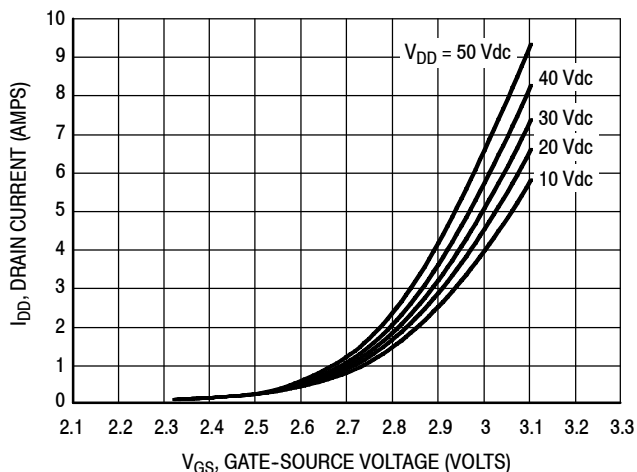
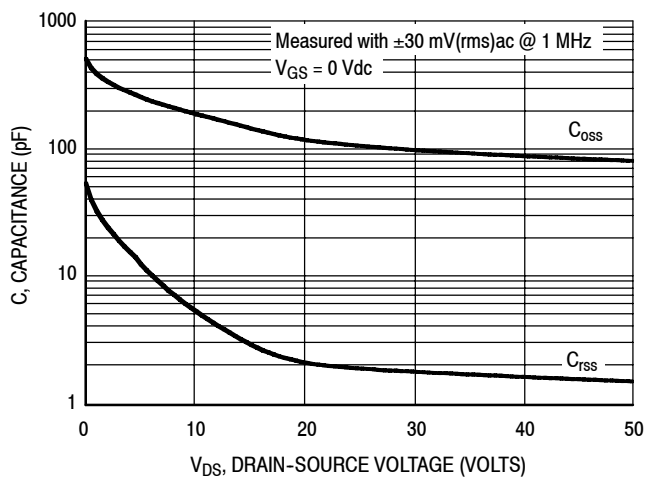

Figure 4. Normalized  $V_{GS}$  Quiescent versus Case Temperature



Note: Measured with both sides of the transistor tied together.  
Figure 5. Drain Current versus Gate-Source Voltage



Note: Each side of device measured separately.

Figure 6. Capacitance versus Drain-Source Voltage

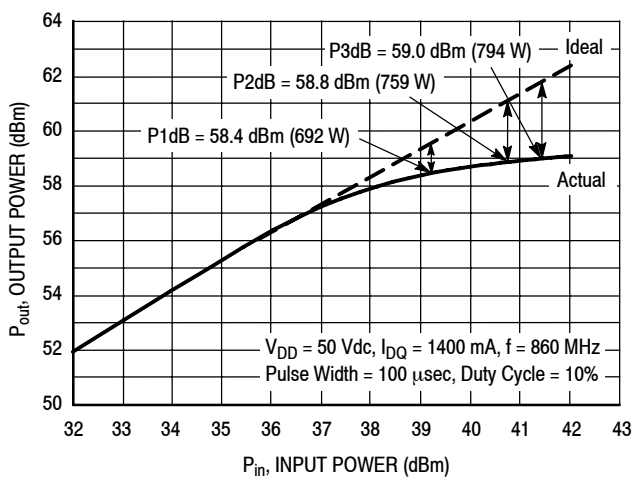

Figure 7. Pulsed CW Output Power versus Input Power

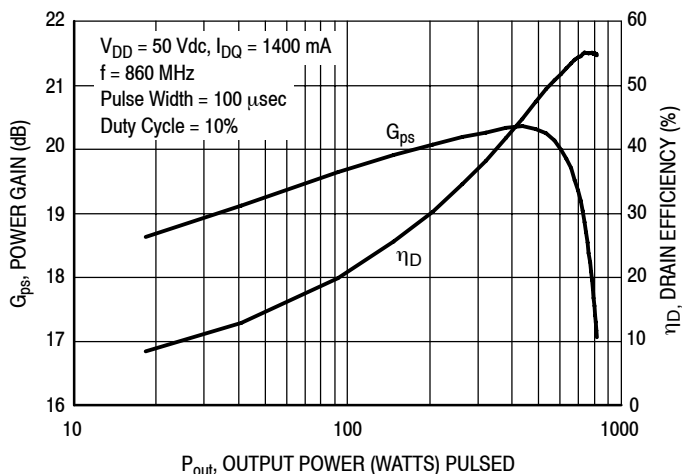

Figure 8. Pulsed Power Gain and Drain Efficiency versus Output Power

MRFE6VP8600HR6 MRFE6VP8600HR5 MRFE6VP8600HSR6 MRFE6VP8600HSR5

## TYPICAL CHARACTERISTICS — DVB-T (8k OFDM)

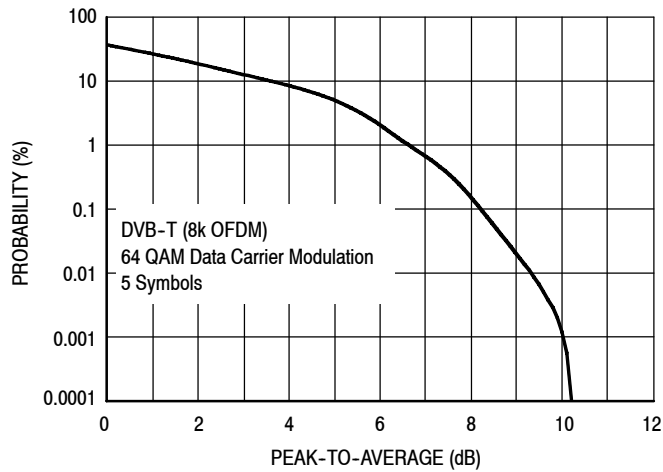

Figure 9. Source Peak-to-Average DVB-T (8k OFDM)

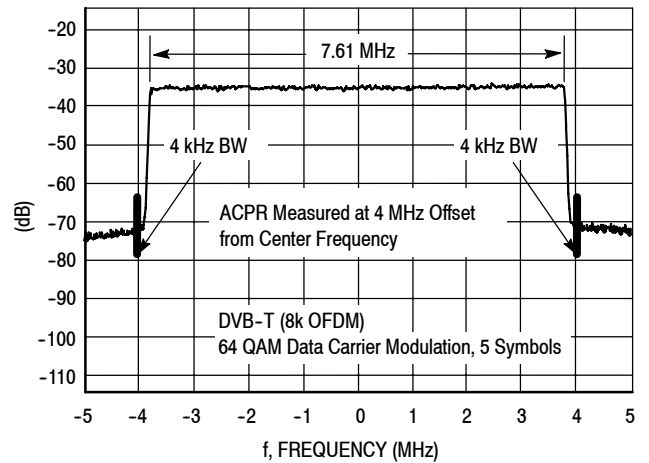

Figure 10. DVB-T (8k OFDM) Spectrum

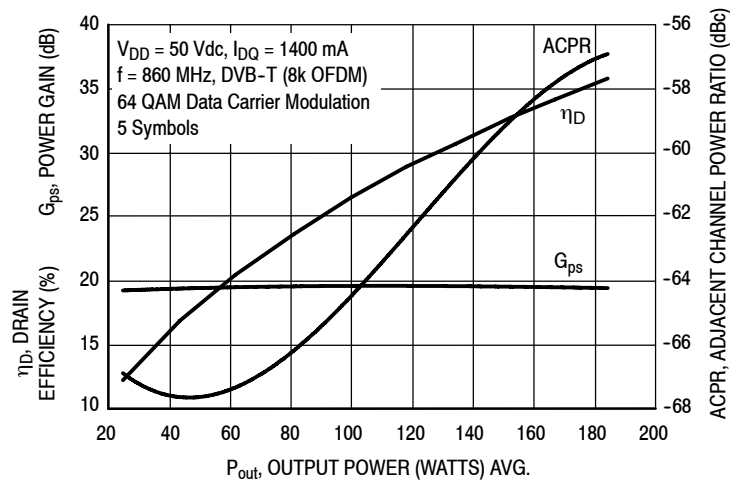
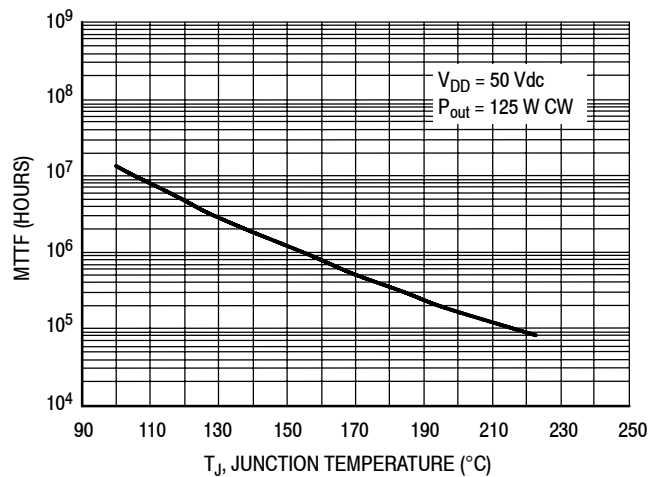

Figure 11. Single-Carrier DVB-T (8k OFDM) Drain Efficiency, Power Gain and ACPR versus Output Power

## TYPICAL CHARACTERISTICS



**Note:** The MTTF calculation for this graph is based on the thermal resistance of the part using thermal grease TIM mounting.

MTTF calculator available at <http://www.freescale.com/rf>. Select Software & Tools/Development Tools/Calculators to access MTTF calculators by product.

**Figure 12. MTTF versus Junction Temperature - CW**

$V_{DD} = 50$  Vdc,  $I_{DQ} = 1400$  mA,  $P_{out} = 125$  W Avg.

f MHz	$Z_{source}$ $\Omega$	$Z_{load}$ $\Omega$
860	$1.14 + j0.88$	$2.61 + j1.84$

$Z_{source}$  = Test circuit impedance as measured from gate to gate, balanced configuration.

$Z_{load}$  = Test circuit impedance as measured from drain to drain, balanced configuration.

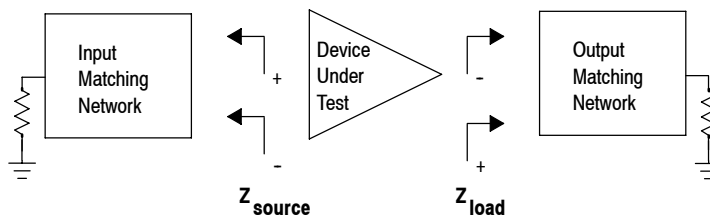

**Figure 13. Series Equivalent Source and Load Impedance**



### 470-860 MHz REFERENCE CIRCUIT

$V_{DD} = 50$  Volts,  $I_{DQ} = 1400$  mA, Channel Bandwidth = 8 MHz, Input Signal PAR = 9.5 dB @ 0.01% Probability on CCDF,  $T_C = 50^\circ\text{C}$ .

Signal Type	$P_{out}$ (W)	f (MHz)	$G_{ps}$ (dB)	$\eta_D$ (%)	Output PAR (dB)	IMD Shoulder (dBc)
DVB-T (8k OFDM)	125 Avg.	470	19.0	27.2	8.2	-31.1
		650	20.3	30.6	7.6	-30.3
		860	19.0	27.9	7.7	-30.4

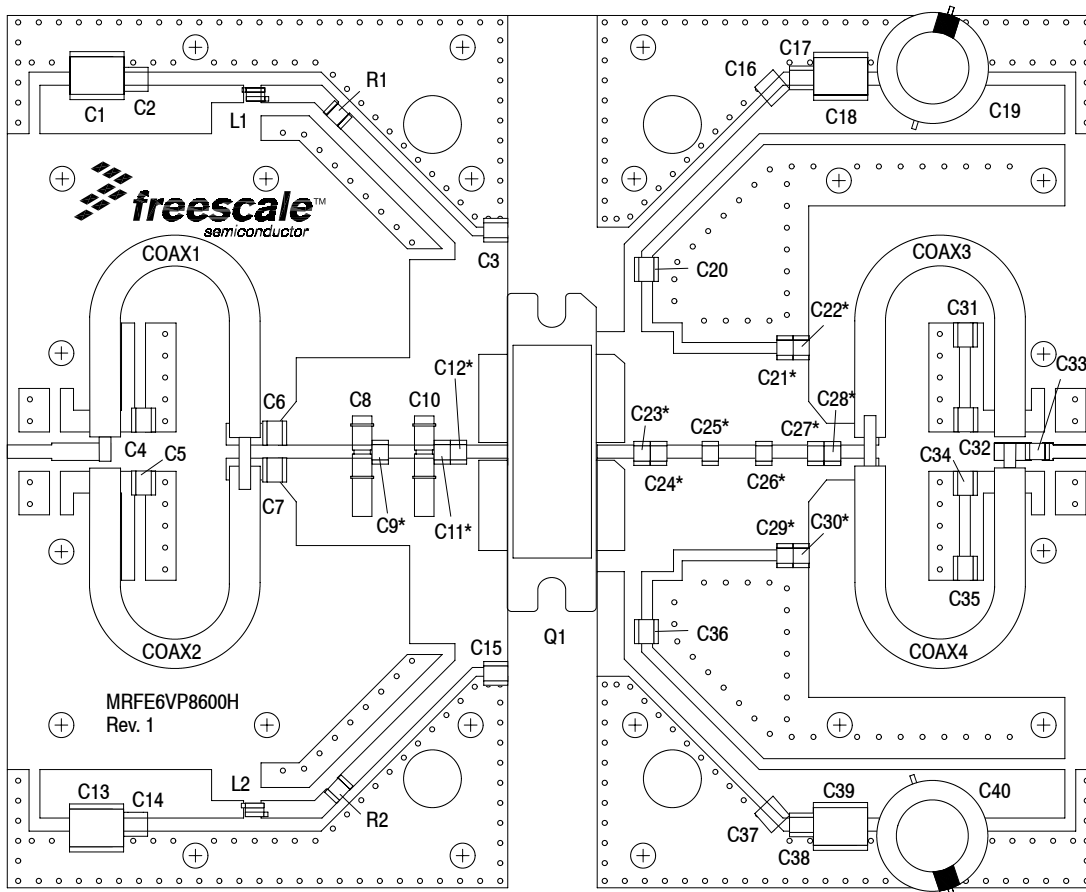

\*C9, C11, C12, C21, C22, C23, C24, C25, C26, C27, C28, C29, C30 and C33 are mounted vertically.

Figure 14. MRFE6VP8600HR6(HSR6) Broadband Test Circuit Component Layout — 470-860 MHz

## 470-860 MHz REFERENCE CIRCUIT

**Table 6. MRFE6VP8600HR6(HSR6) Broadband Test Circuit Component Designations and Values — 470-860 MHz**

Part	Description	Part Number	Manufacturer
C1, C13	10 $\mu$ F, 50 V Chip Capacitors	GRM55DR61H106KA88L	Murata
C2, C14	2.2 $\mu$ F, 50 V Chip Capacitors	C3225X7R1H225K	TDK
C3, C15	10 pF Chip Capacitors	ATC100B100JT500XT	ATC
C4, C5	47 pF Chip Capacitors	ATC100B470JT500XT	ATC
C6, C7	27 pF Chip Capacitors	ATC100B270JT500XT	ATC
C8, C10	0.8-8.0 pF Variable Capacitors	27291SL	Johanson Components
C9, C28	8.2 pF Chip Capacitors	ATC100B8R2CT500XT	ATC
C11, C12	6.8 pF Chip Capacitors	ATC800B6R8BT500XT	ATC
C16, C37	39,000 pF Chip Capacitors	ATC200B393KT50XT	ATC
C17, C38	2.2 $\mu$ F, 100 V Chip Capacitors	C3225X7R2A225KT	TDK
C18, C39	4.7 $\mu$ F, 100 V Chip Capacitors	GRM55ER72A475KA01B	Murata
C19, C40	220 $\mu$ F, 100 V Electrolytic Capacitors	EEV-FK2A221M	Panasonic-ECG
C20, C36	56 pF Chip Capacitors	ATC100B560CT500XT	ATC
C21, C25, C29	7.5 pF Chip Capacitors	ATC800B7R5CT500XT	ATC
C22, C30	8.2 pF Chip Capacitors	ATC800B8R2CT500XT	ATC
C23	13 pF Chip Capacitor	ATC800B130JT500XT	ATC
C24	9.1 pF Chip Capacitor	ATC800B9R1CT500XT	ATC
C26	3.3 pF Chip Capacitor	ATC800B3R3CT500XT	ATC
C27	3.9 pF Chip Capacitor	ATC100B3R9CT500XT	ATC
C31, C35	1,000 pF Chip Capacitors	ATC100B102JT50XT	ATC
C32, C33, C34	120 pF Chip Capacitors	ATC100B121JT500XT	ATC
L1, L2	5.0 nH, 2 Turn Inductors	A02TKLC	Coilcraft
R1, R2	10 $\Omega$ , 1/4 W Chip Resistors	CRCW120610R0JNEA	Vishay
Coax1, 2, 3, 4	25 $\Omega$ SemiRigid Coax, Length 2.0"	UT-141C-25	Micro-Coax
Q1	RF Power LDMOS Transistor	MRFE6VP8600HR6	Freescale
PCB	0.030", $\epsilon_r = 3.5$	RO4350B	Rogers

**Table 7. MRFE6VP8600HR6(HSR6) Broadband Test Circuit Microstrips — 470-860 MHz**

Microstrip	Description
Z1	0.204" x 0.062" Microstrip
Z2	0.245" x 0.080" Microstrip
Z3, Z4	0.445" x 0.060" Microstrip
Z5, Z6	0.019" x 0.100" Microstrip
Z7, Z8	0.305" x 0.400" Microstrip
Z9, Z10	0.083" x 0.400" Microstrip
Z11, Z12	0.095" x 0.400" Microstrip
Z13, Z14	0.055" x 0.850" Microstrip
Z15, Z16	0.083" x 0.850" Microstrip
Z17, Z18	0.071" x 0.850" Microstrip
Z19, Z20	0.187" x 0.960" Microstrip
Z21, Z22	0.055" x 0.960" Microstrip
Z23, Z24	0.780" x 0.080" Microstrip
Z25*, Z26*	0.354" x 0.080" Microstrip
Z27, Z28	0.164" x 0.520" Microstrip
Z29, Z30	0.074" x 0.520" Microstrip
Z31, Z32	0.075" x 0.520" Microstrip

Microstrip	Description
Z33, Z34	0.038" x 0.520" Microstrip
Z35, Z36	0.170" x 0.420" Microstrip
Z37, Z38	0.269" x 0.420" Microstrip
Z39, Z40	0.069" x 0.420" Microstrip
Z41, Z42	0.075" x 0.420" Microstrip
Z43, Z44	0.038" x 0.420" Microstrip
Z45, Z46	0.038" x 0.100" Microstrip
Z47, Z48	0.075" x 0.100" Microstrip
Z49, Z50	0.169" x 0.100" Microstrip
Z51, Z52	0.389" x 0.060" Microstrip
Z53	0.070" x 0.080" Microstrip
Z54	0.018" x 0.080" Microstrip
Z55	0.204" x 0.062" Microstrip
Z56, Z57	0.278" x 0.080" Microstrip
Z58*, Z59*	0.886" x 0.080" Microstrip

\* Line length includes microstrip bends

**MRFE6VP8600HR6 MRFE6VP8600HR5 MRFE6VP8600HSR6 MRFE6VP8600HSR5**

RF Device Data  
Freescale Semiconductor

### 470-860 MHz REFERENCE CIRCUIT

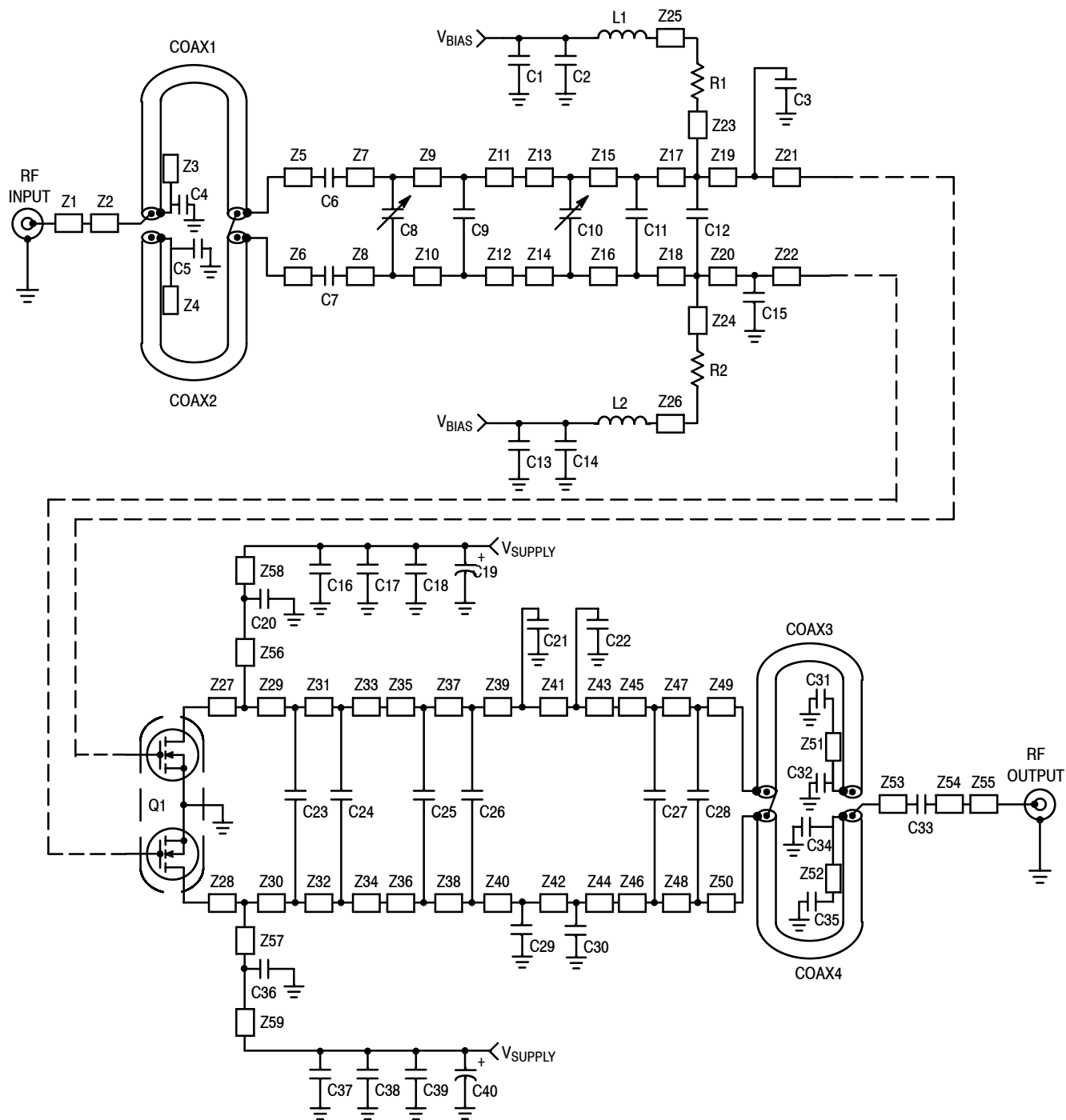

**Figure 15. MRFE6VP8600HR6(HSR6) Broadband Test Circuit Schematic — 470-860 MHz**

TYPICAL CHARACTERISTICS — 470-860 MHz REFERENCE CIRCUIT

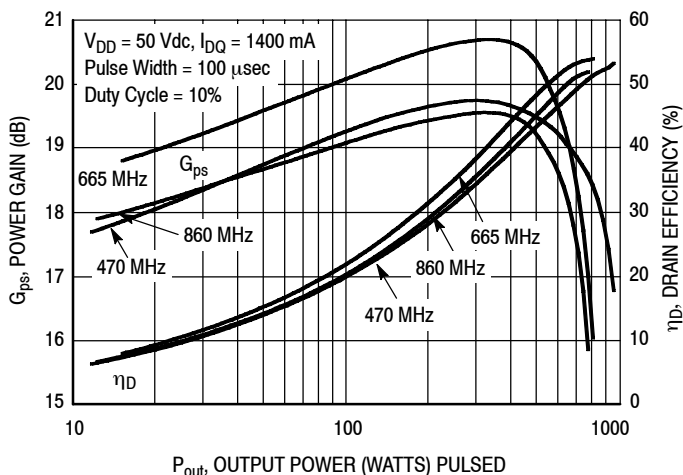

Figure 16. Broadband Pulsed Power Gain and Drain Efficiency versus Output Power — 470-860 MHz

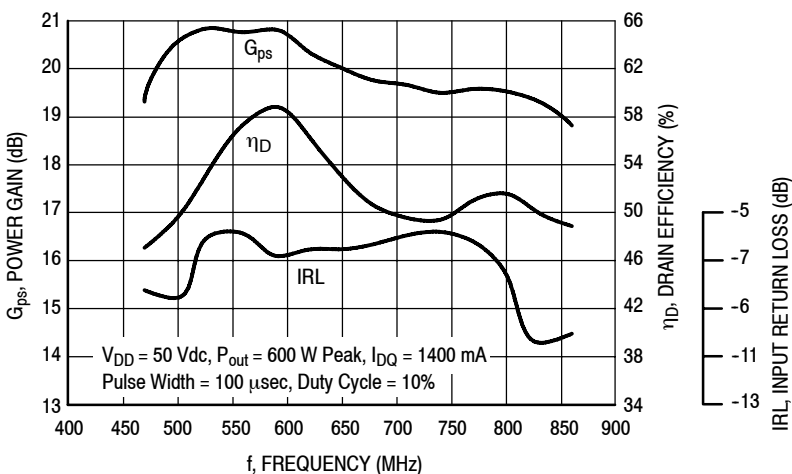
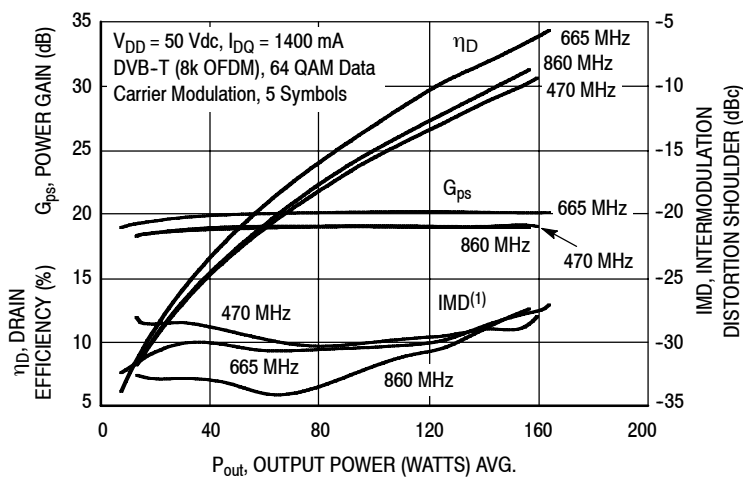

Figure 17. Broadband Pulsed Power Gain, Drain Efficiency and IRL versus Frequency



(1) Intermodulation distortion shoulder measurement made using delta marker at 4.2 MHz offset from center frequency.

Figure 18. DVB-T (8k OFDM) Drain Efficiency, Power Gain and IMD Shoulder versus Output Power — 470-860 MHz

## TYPICAL CHARACTERISTICS — 470-860 MHz REFERENCE CIRCUIT

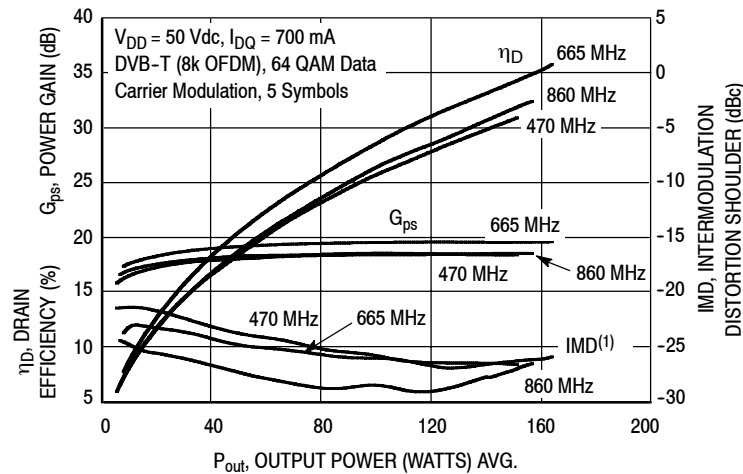

(1) Intermodulation distortion shoulder measurement made using delta marker at 4.2 MHz offset from center frequency.

**Figure 19. DVB-T (8k OFDM) Drain Efficiency, Power Gain and IMD Shoulder versus Output Power — 470-860 MHz**

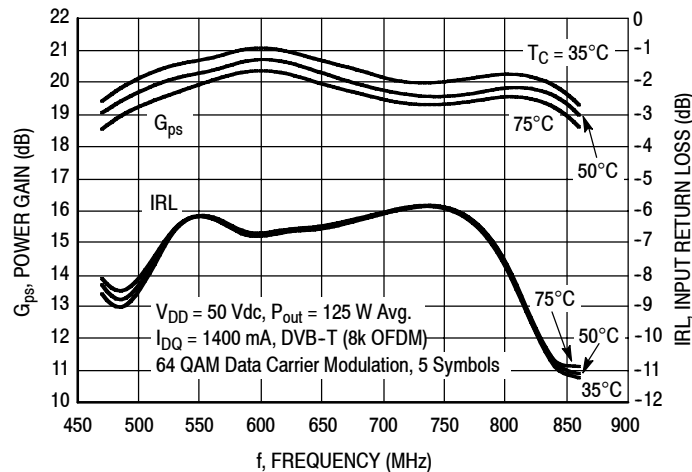

**Figure 20. Broadband Power Gain and IRL versus Frequency**

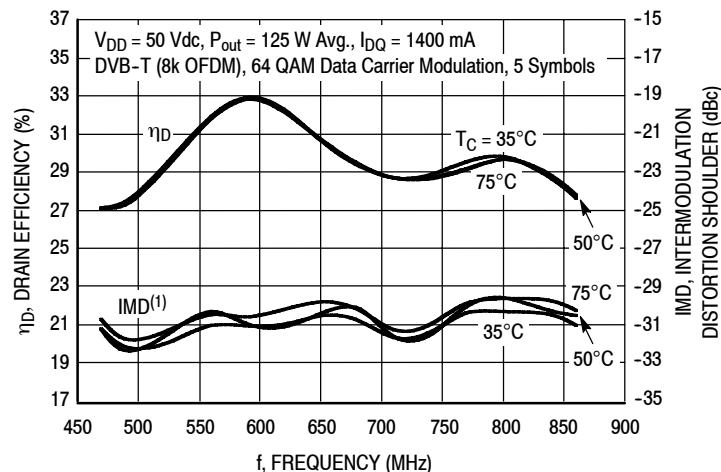

(1) Intermodulation distortion shoulder measurement made using delta marker at 4.2 MHz offset from center frequency.

**Figure 21. Broadband Drain Efficiency and IMD Shoulder versus Frequency**

MRFE6VP8600HR6 MRFE6VP8600HR5 MRFE6VP8600HSR6 MRFE6VP8600HSR5

### 470-860 MHz REFERENCE CIRCUIT

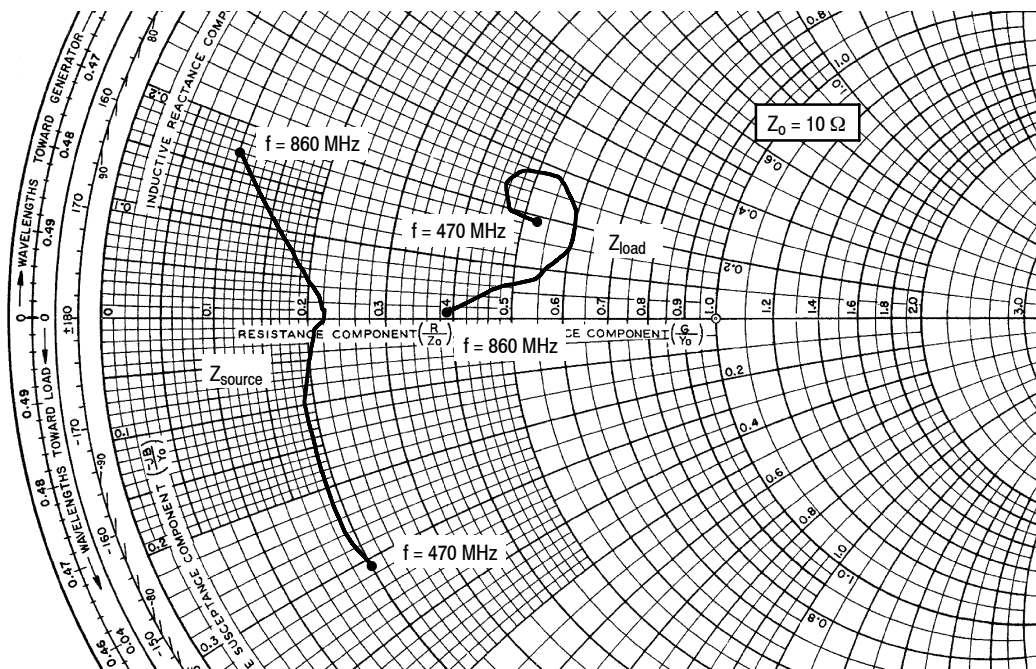

$V_{DD} = 50 \text{ Vdc}$ ,  $I_{DQ} = 1400 \text{ mA}$ ,  $P_{out} = 125 \text{ W Avg.}$

f MHz	Z <sub>source</sub> Ω	Z <sub>load</sub> Ω
470	1.96 - j3.13	5.30 + j1.92
500	1.91 - j2.46	4.65 + j1.95
530	1.88 - j1.86	4.50 + j2.35
560	1.91 - j1.37	4.71 + j2.66
590	1.93 - j0.94	5.40 + j2.75
620	1.99 - j0.49	5.93 + j2.29
650	2.11 - j0.14	6.03 + j1.81
680	2.17 + j0.02	6.04 + j1.45
710	2.14 + j0.26	5.58 + j0.95
740	2.11 + j0.32	5.37 + j0.80
770	1.92 + j0.56	4.80 + j0.56
800	1.65 + j0.91	4.78 + j0.55
830	1.50 + j1.07	4.59 + j0.45
860	0.95 + j1.72	3.93 + j0.11

Z<sub>source</sub> = Test circuit impedance as measured from gate to gate, balanced configuration.

Z<sub>load</sub> = Test circuit impedance as measured from drain to drain, balanced configuration.

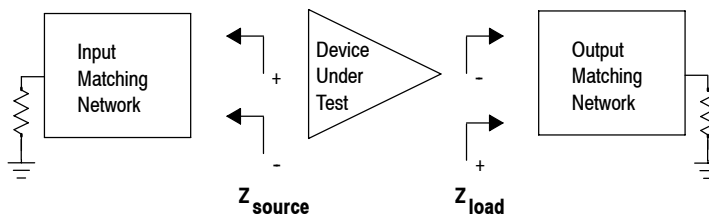
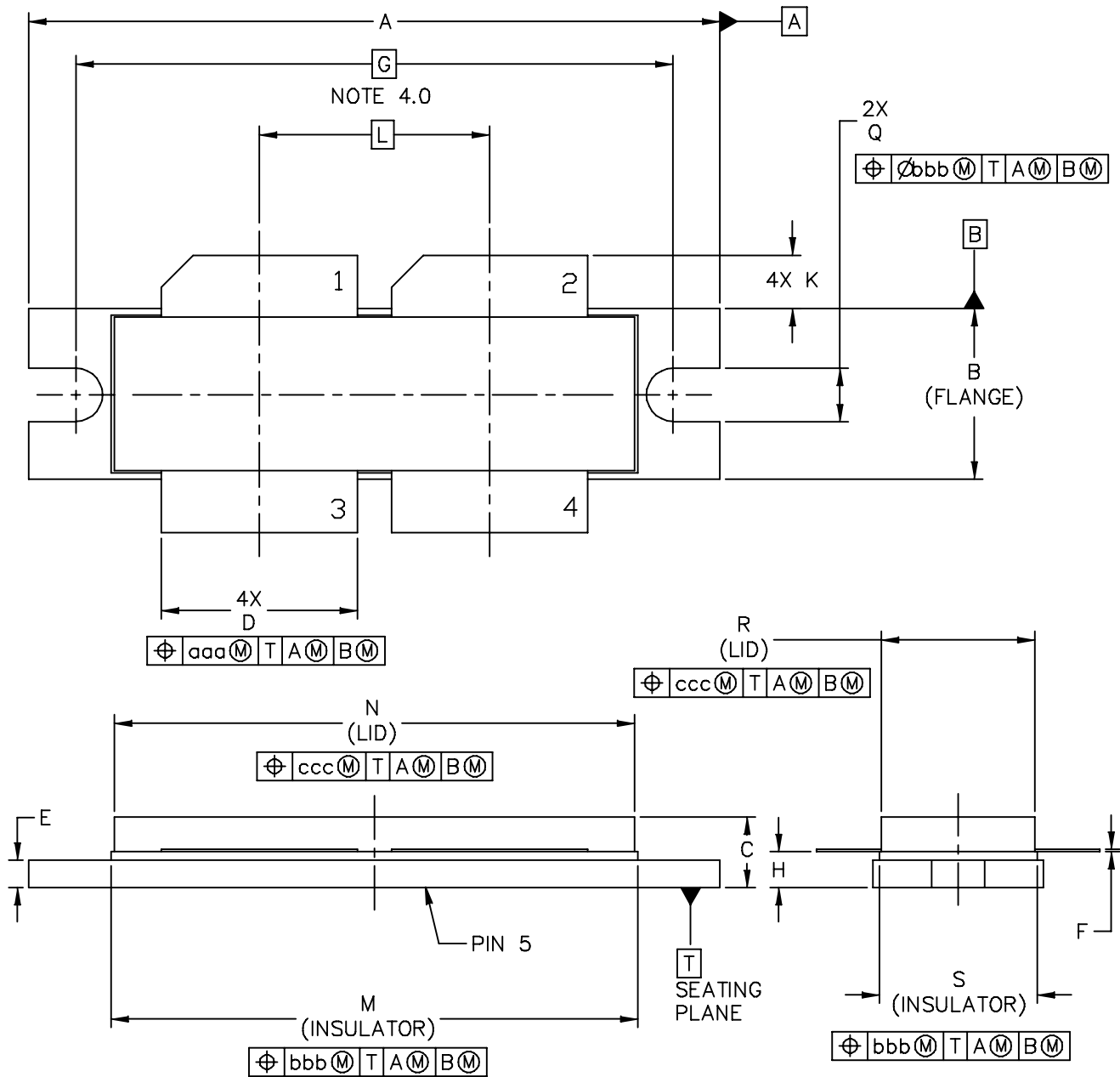

Figure 22. Broadband Series Equivalent Source and Load Impedance — 470-860 MHz

### PACKAGE DIMENSIONS



© FREESCALE SEMICONDUCTOR, INC. ALL RIGHTS RESERVED.	MECHANICAL OUTLINE	PRINT VERSION NOT TO SCALE
TITLE:  <div style="text-align: center; font-size: 1.2em;">NI-1230</div>	DOCUMENT NO: 98ASB16977C CASE NUMBER: 375D-05 STANDARD: NON-JEDEC	REV: E 31 MAR 2005

**MRFE6VP8600HR6 MRFE6VP8600HR5 MRFE6VP8600HSR6 MRFE6VP8600HSR5**

NOTES:

- 1.0 INTERPRET DIMENSIONS AND TOLERANCES PER ASME Y14.5M-1994.
- 2.0 CONTROLLING DIMENSION: INCH
- 3.0 DIMENSION H IS MEASURED .030 (0.762) AWAY FROM PACKAGE BODY.
- 4.0 RECOMMENDED BOLT CENTER DIMENSION OF 1.52 (38.61) BASED ON M3 SCREW.

STYLE 1:

- PIN 1 - DRAIN
- 2 - DRAIN
- 3 - GATE
- 4 - GATE
- 5 - SOURCE

DIM	INCH		MILLIMETER		DIM	INCH		MILLIMETER	
	MIN	MAX	MIN	MAX		MIN	MAX	MIN	MAX
A	1.615	1.625	41.02	41.28	N	1.218	1.242	30.94	31.55
B	.395	.405	10.03	10.29	Q	.120	.130	3.05	3.3
C	.150	.200	3.81	5.08	R	.355	.365	9.01	9.27
D	.455	.465	11.56	11.81	S	.365	.375	9.27	9.53
E	.062	.066	1.57	1.68					
F	.004	.007	0.1	0.18					
G	1.400 BSC		35.56 BSC		aaa	.013		0.33	
H	.082	.090	2.08	2.29	bbb	.010		0.25	
K	.117	.137	2.97	3.48	ccc	.020		0.51	
L	.540 BSC		13.72 BSC						
M	1.219	1.241	30.96	31.52					
© FREESCALE SEMICONDUCTOR, INC. ALL RIGHTS RESERVED.			MECHANICAL OUTLINE			PRINT VERSION NOT TO SCALE			
TITLE:  NI-1230					DOCUMENT NO: 98ASB16977C			REV: E	
					CASE NUMBER: 375D-05			31 MAR 2005	
					STANDARD: NON-JEDEC				



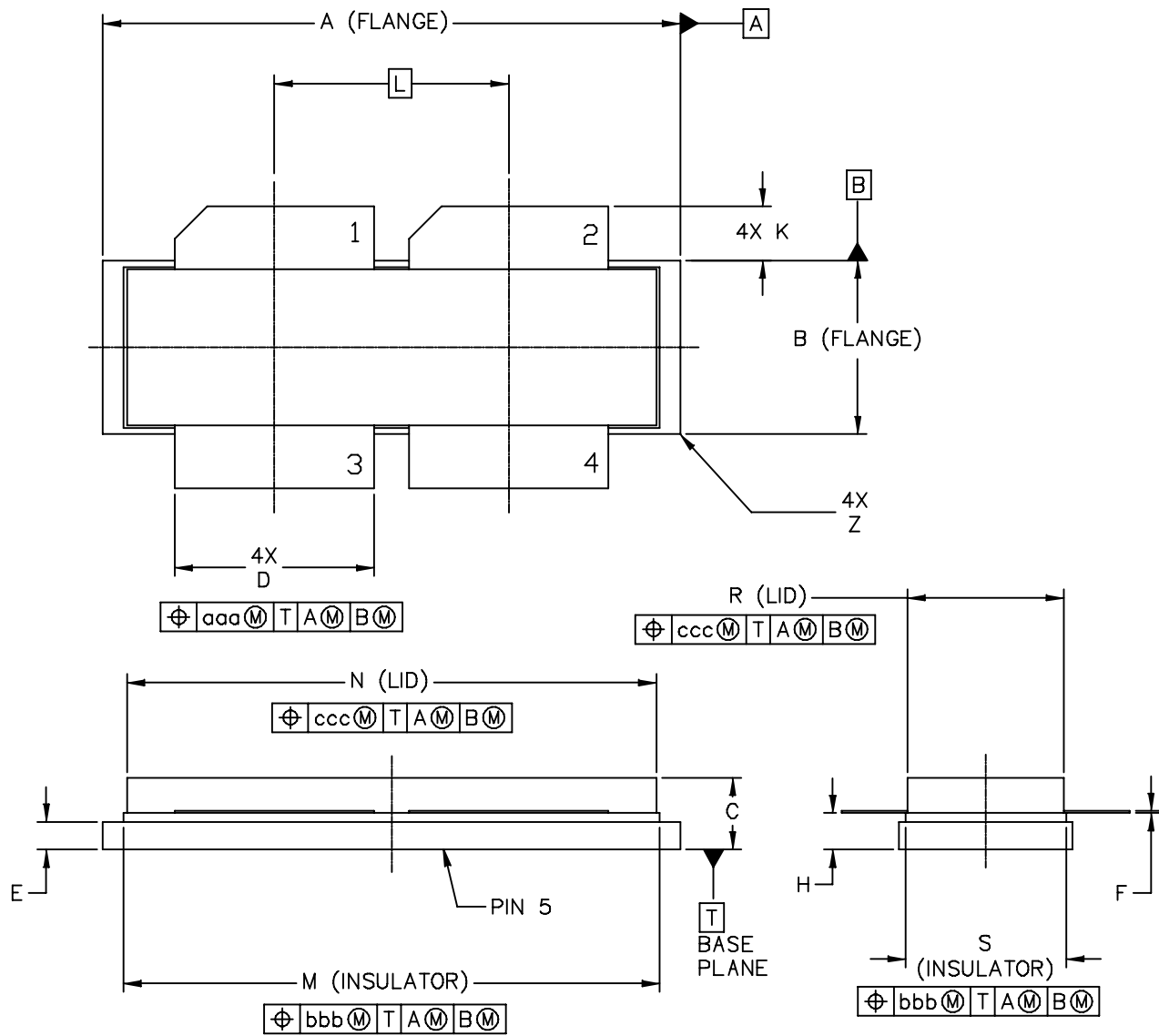

© FREESCALE SEMICONDUCTOR, INC. ALL RIGHTS RESERVED.		MECHANICAL OUTLINE		PRINT VERSION NOT TO SCALE	
TITLE:  NI-1230S		DOCUMENT NO: 98ARB18247C		REV: F	
		CASE NUMBER: 375E-04		05 AUG 2005	
		STANDARD: NON-JEDEC			

MRFE6VP8600HR6 MRFE6VP8600HR5 MRFE6VP8600HSR6 MRFE6VP8600HSR5

NOTES:

1. INTERPRET DIMENSIONS AND TOLERANCES PER ASME Y14.5M-1994.
2. CONTROLLING DIMENSION: INCH
3. DIMENSION H IS MEASURED .030 AWAY FROM PACKAGE BODY

STYLE 1:

- PIN 1 - DRAIN
- 2 - DRAIN
- 3 - GATE
- 4 - GATE
- 5 - SOURCE

DIM	INCHES		MILLIMETERS		DIM	INCHES		MILLIMETERS	
	MIN	MAX	MIN	MAX		MIN	MAX	MIN	MAX
A	1.265	1.275	32.13	32.38	R	.355	.365	9.01	9.27
B	.395	.405	10.03	10.29	S	.365	.375	9.27	9.53
C	.150	.200	3.81	5.08	Z	---	.040	---	1.02
D	.455	.465	11.56	11.81					
E	.062	.066	1.57	1.68	aaa	.013		0.33	
F	.004	.007	0.1	0.18	bbb	.010		0.25	
H	.082	.090	2.08	2.29	ccc	.020		0.51	
K	.117	.137	2.97	3.48					
L	.540 BSC		13.72 BSC						
M	1.219	1.241	30.96	31.52					
N	1.218	1.242	30.94	31.55					
© FREESCALE SEMICONDUCTOR, INC. ALL RIGHTS RESERVED.			MECHANICAL OUTLINE			PRINT VERSION NOT TO SCALE			
TITLE:  NI-1230S					DOCUMENT NO: 98ARB18247C			REV: F	
					CASE NUMBER: 375E-04			05 AUG 2005	
					STANDARD: NON-JEDEC				

## PRODUCT DOCUMENTATION, SOFTWARE AND TOOLS

Refer to the following documents to aid your design process.

### Application Notes

- AN1908: Solder Reflow Attach Method for High Power RF Devices in Air Cavity Packages
- AN1955: Thermal Measurement Methodology of RF Power Amplifiers

### Engineering Bulletins

- EB212: Using Data Sheet Impedances for RF LDMOS Devices

### Software

- Electromigration MTTF Calculator
- RF High Power Model
- .s2p File

### Development Tools

- Printed Circuit Boards

For Software and Tools, do a Part Number search at <http://www.freescale.com>, and select the "Part Number" link. Go to the Software & Tools tab on the part's Product Summary page to download the respective tool.

## REVISION HISTORY

The following table summarizes revisions to this document.

Revision	Date	Description
0	Sept. 2011	• Initial Release of Data Sheet
1	Sept. 2011	• Added Fig. 19, DVB-T (8k OFDM) Drain Efficiency, Power Gain and IMD Shoulder versus Output Power - 470-860 MHz @ 700 mA to indicate efficiency gains with appropriate precorrection systems, p. 13

## **How to Reach Us:**

### **Home Page:**

[www.freescale.com](http://www.freescale.com)

### **Web Support:**

<http://www.freescale.com/support>

### **USA/Europe or Locations Not Listed:**

Freescale Semiconductor, Inc.  
Technical Information Center, EL516  
2100 East Elliot Road  
Tempe, Arizona 85284  
1-800-521-6274 or +1-480-768-2130  
[www.freescale.com/support](http://www.freescale.com/support)

### **Europe, Middle East, and Africa:**

Freescale Halbleiter Deutschland GmbH  
Technical Information Center  
Schatzbogen 7  
81829 Muenchen, Germany  
+44 1296 380 456 (English)  
+46 8 52200080 (English)  
+49 89 92103 559 (German)  
+33 1 69 35 48 48 (French)  
[www.freescale.com/support](http://www.freescale.com/support)

### **Japan:**

Freescale Semiconductor Japan Ltd.  
Headquarters  
ARCO Tower 15F  
1-8-1, Shimo-Meguro, Meguro-ku,  
Tokyo 153-0064  
Japan  
0120 191014 or +81 3 5437 9125  
[support.japan@freescale.com](mailto:support.japan@freescale.com)

### **Asia/Pacific:**

Freescale Semiconductor China Ltd.  
Exchange Building 23F  
No. 118 Jianguo Road  
Chaoyang District  
Beijing 100022  
China  
+86 10 5879 8000  
[support.asia@freescale.com](mailto:support.asia@freescale.com)

### **For Literature Requests Only:**

Freescale Semiconductor Literature Distribution Center  
1-800-441-2447 or +1-303-675-2140  
Fax: +1-303-675-2150  
[LDCForFreescaleSemiconductor@hibbertgroup.com](mailto:LDCForFreescaleSemiconductor@hibbertgroup.com)

Information in this document is provided solely to enable system and software implementers to use Freescale Semiconductor products. There are no express or implied copyright licenses granted hereunder to design or fabricate any integrated circuits or integrated circuits based on the information in this document.

Freescale Semiconductor reserves the right to make changes without further notice to any products herein. Freescale Semiconductor makes no warranty, representation or guarantee regarding the suitability of its products for any particular purpose, nor does Freescale Semiconductor assume any liability arising out of the application or use of any product or circuit, and specifically disclaims any and all liability, including without limitation consequential or incidental damages. "Typical" parameters that may be provided in Freescale Semiconductor data sheets and/or specifications can and do vary in different applications and actual performance may vary over time. All operating parameters, including "Typicals", must be validated for each customer application by customer's technical experts. Freescale Semiconductor does not convey any license under its patent rights nor the rights of others. Freescale Semiconductor products are not designed, intended, or authorized for use as components in systems intended for surgical implant into the body, or other applications intended to support or sustain life, or for any other application in which the failure of the Freescale Semiconductor product could create a situation where personal injury or death may occur. Should Buyer purchase or use Freescale Semiconductor products for any such unintended or unauthorized application, Buyer shall indemnify and hold Freescale Semiconductor and its officers, employees, subsidiaries, affiliates, and distributors harmless against all claims, costs, damages, and expenses, and reasonable attorney fees arising out of, directly or indirectly, any claim of personal injury or death associated with such unintended or unauthorized use, even if such claim alleges that Freescale Semiconductor was negligent regarding the design or manufacture of the part.

Freescale™ and the Freescale logo are trademarks of Freescale Semiconductor, Inc. All other product or service names are the property of their respective owners.

© Freescale Semiconductor, Inc. 2011. All rights reserved.

