

Features

- Dual Zeners in Common Anode Configuration
- 300 mW Power Dissipation Rating
- Ideally Suited for Automated Insertion
- ΔV_Z For Both Diodes in One Case is $\leq 5\%$
- Common Cathode Style Available See DZ Series
- **Lead, Halogen and Antimony Free, RoHS Compliant (Note 2)**
- **“Green” Device (Note 3)**
- **Qualified to AEC-Q101 Standards for High Reliability**

ESD Sensitivity Rating

- AEC-Q101, HBM - 8kV, MM - 400V
- IEC 61000-4-2, Air - 15kV, Contact - 8kV



Top View

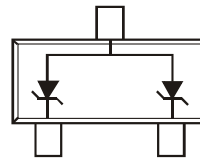

Device Schematic

Thermal Characteristics

Characteristic	Symbol	Value	Unit
Power Dissipation (Note 1)	P_D	300	mW
Thermal Resistance, Junction to Ambient Air (Note 1)	$R_{\theta JA}$	417	$^{\circ}C/W$
Operating and Storage Temperature Range	T_J, T_{STG}	-65 to +150	$^{\circ}C$

- Notes:
1. Mounted on FR4 PC Board with recommended pad layout which can be found on our website at <http://www.diodes.com/datasheets/ap02001.pdf>.
 2. No purposefully added lead.
 3. Product manufactured with Data Code V9 (week 33, 2008) and newer are built with Green Molding Compound. Product manufactured prior to Date Code V9 are built with Non-Green Molding Compound and may contain Halogens or Sb_2O_3 Fire Retardants.

Electrical Characteristics @T_A = 25°C unless otherwise specified

Type Number	Marking Code	Zener Voltage Range (Note 4)	Maximum Zener Impedance (Note 5)		Typical Temperature Coefficient T _C (%/°C)	Min. Reverse Voltage (Note 4) @ I _R = 0.1µA V _R (Volts)
		@ I _{ZT} = 5.0mA	Z _{ZT} @ I _{ZT} = 5.0mA	Z _{ZK} @ I _{ZK} = 1.0mA		
		V _Z (Volts)	Ohms	Ohms		
AZ23C2V7	KD1	2.5-2.9	83	500	-0.065	—
AZ23C3V0	KD2	2.8-3.2	95	500	-0.060	—
AZ23C3V3	KD3	3.1-3.5	95	500	-0.055	—
AZ23C3V6	KD4	3.4-3.8	95	500	-0.055	—
AZ23C3V9	KD5	3.7-4.1	95	500	-0.050	—
AZ23C4V3	KD6	4.0-4.6	95	500	-0.035	—
AZ23C4V7	KD7	4.4-5.0	78	500	-0.015	—
AZ23C5V1	KD8	4.8-5.4	60	480	+0.005	0.8
AZ23C5V6	KD9	5.2-6.0	40	400	+0.020	1.0
AZ23C6V2	KDA	5.8-6.6	10	200	+0.030	2.0
AZ23C6V8	KDB	6.4-7.2	8.0	150	+0.045	3.0
AZ23C7V5	KDC	7.0-7.9	7.0	50	+0.050	5.0
AZ23C8V2	KDD	7.7-8.7	7.0	50	+0.055	6.0
AZ23C9V1	KDE	8.5-9.6	10	50	+0.065	7.0
AZ23C10	KDF	9.4-10.6	15	70	+0.065	7.5
AZ23C11	KDG	10.4-11.6	20	70	+0.070	8.5
AZ23C12	KDH	11.4-12.7	20	90	+0.075	9.0
AZ23C13	KDI	12.4-14.1	25	110	+0.080	10.0
AZ23C15	KDJ	13.8-15.6	30	110	+0.080	11.0
AZ23C16	KDK	15.3-17.1	40	170	+0.090	12.0
AZ23C18	KDL	16.8-19.1	50	170	+0.090	14.0
AZ23C20	KDM	18.8-21.2	50	220	+0.090	15.0
AZ23C22	KDN	20.8-23.3	55	220	+0.090	17.0
AZ23C24	KDO	22.8-25.6	80	220	+0.090	18.0
AZ23C27	KDP	25.1-28.9	80	250	+0.090	20.0
AZ23C30	KDQ	28-32	80	250	+0.090	22.5
AZ23C33	KDR	31-35	80	250	+0.090	25.0
AZ23C36	KDS	34-38	90	250	+0.090	27.0
AZ23C39	KDT	37-41	90	300	+0.110	29.0
AZ23C43	D30	40-46	100	700	+0.110	32.0
AZ23C47	D31	44-50	100	750	+0.110	35.0
AZ23C51	D32	48-54	100	750	+0.110	38.0

Notes: 4. Short duration pulse test used to minimize self-heating effect.
5. f = 1kHz.

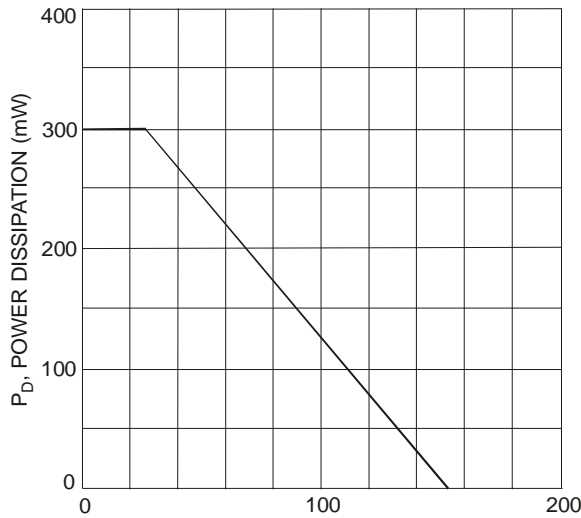

Fig. 1 Power Derating Curve

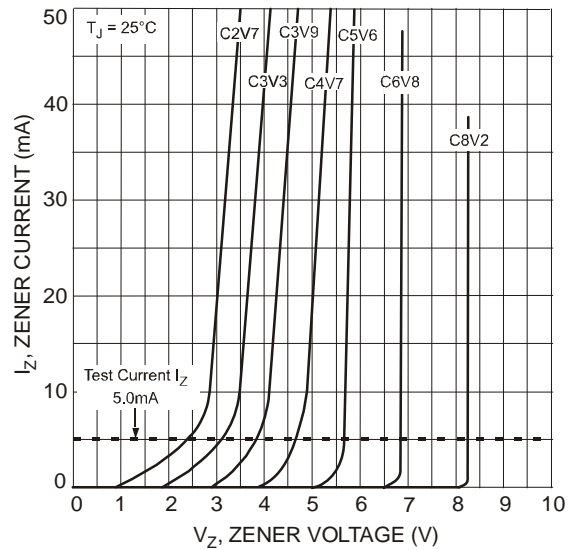

Fig. 2 Typical Zener Breakdown Characteristics

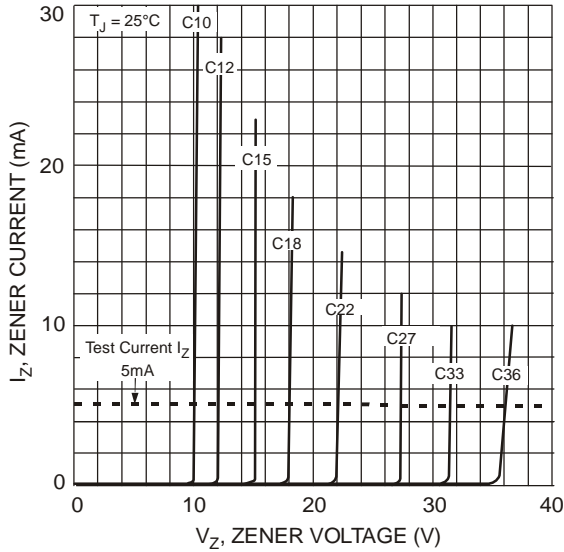

Fig. 3 Typical Zener Breakdown Characteristics

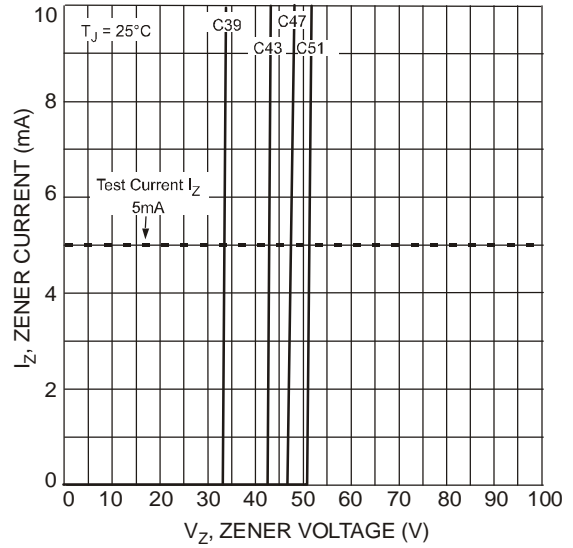

Fig. 4 Typical Zener Breakdown Characteristics

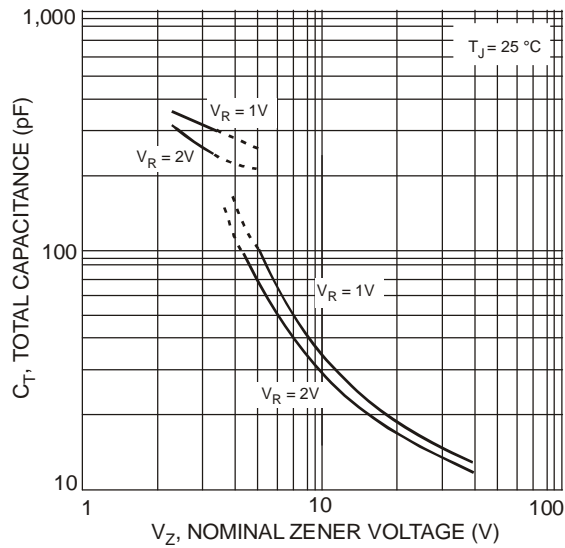

Fig. 5 Typical Total Capacitance vs. Nominal Zener Voltage

Ordering Information (Note 6)

Part Number	Case	Packaging
(Type Number)-7-F*	SOT-23	3000/Tape & Reel

*Add "-7-F" to the appropriate type number in Electrical Characteristics Table on Page 2 example: 6.2V Zener = AZ23C6V2-7F

Notes: 6. For packaging details, go to our website at <http://www.diodes.com/datasheets/ap02007.pdf>.

Marking Information

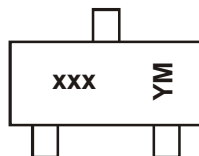

xxx = Product Type Marking Code
(See Electrical Characteristics Table)
YM = Date Code Marking
Y = Year (ex: N = 2002)
M = Month (ex: 9 = September)

Date Code Key

Year	1998	1999	2000	2001	2002	2003	2004	2005	2006	2007	2008	2009	2010	2011	2012
Code	J	K	L	M	N	P	R	S	T	U	V	W	X	Y	Z
Month	Jan	Feb	Mar	Apr	May	Jun	Jul	Aug	Sep	Oct	Nov	Dec			
Code	1	2	3	4	5	6	7	8	9	O	N	D			

Package Outline Dimensions

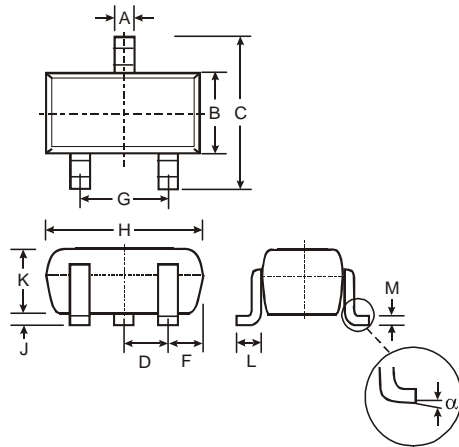

SOT-23		
Dim	Min	Max
A	0.37	0.51
B	1.20	1.40
C	2.30	2.50
D	0.89	1.03
F	0.45	0.60
G	1.78	2.05
H	2.80	3.00
J	0.013	0.10
K	0.903	1.10
L	0.45	0.61
M	0.085	0.180
α	0°	8°
All Dimensions in mm		

Suggested Pad Layout

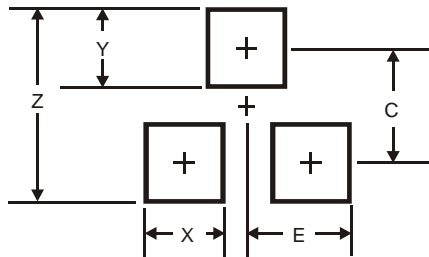

Dimensions	Value (in mm)
Z	2.9
X	0.8
Y	0.9
C	2.0
E	1.35

IMPORTANT NOTICE

Diodes Incorporated and its subsidiaries reserve the right to make modifications, enhancements, improvements, corrections or other changes without further notice to any product herein. Diodes Incorporated does not assume any liability arising out of the application or use of any product described herein; neither does it convey any license under its patent rights, nor the rights of others. The user of products in such applications shall assume all risks of such use and will agree to hold Diodes Incorporated and all the companies whose products are represented on our website, harmless against all damages.

LIFE SUPPORT

Diodes Incorporated products are not authorized for use as critical components in life support devices or systems without the expressed written approval of the President of Diodes Incorporated.