

Color Sensing  
Digital Fiber Sensor  
E3X-DAC-S

OMRON

Easy and Reliable

The Fiber Sensor **That Sees in Color**

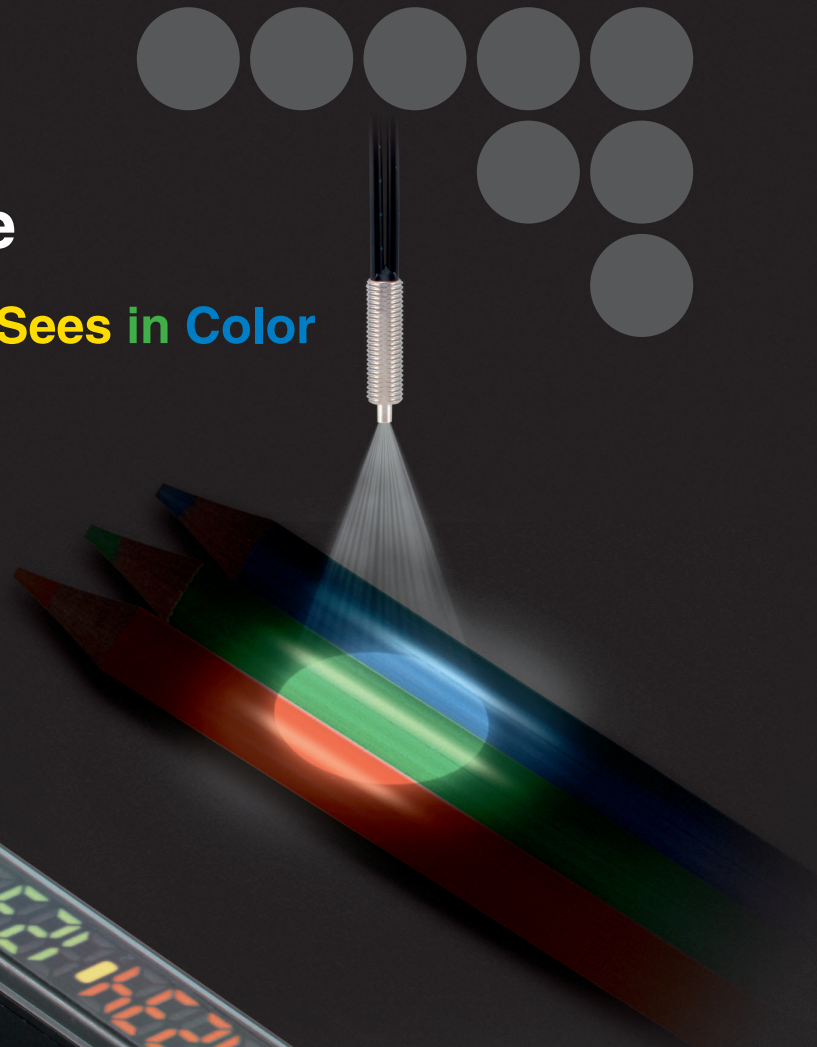

realizing



Color Sensing

# Color-sensing Engine



## Easy and Reliable ... Featuring a Color-sensing Engine

The color-sensing engine uses three parameters, RGB, to process incident light. It detects color information from the workpiece for precise detection of color differences.

Precise Detection

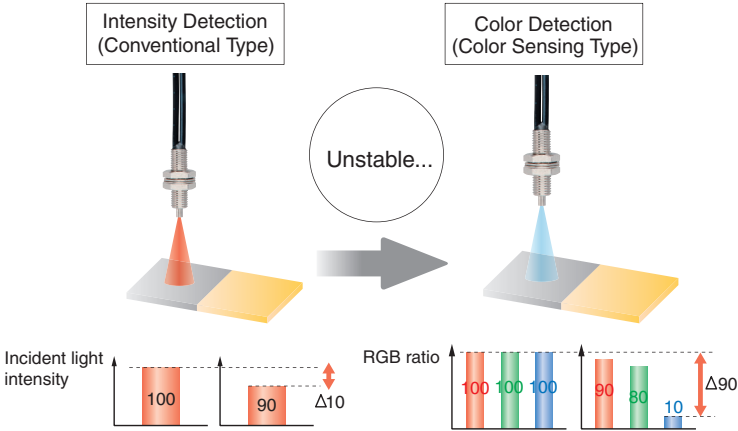

Color VS. Detection Capability

	White	Red	Yellow-red	Yellow	Yellow-green	Green	Blue-green	Blue	Blue-violet	Violet	Red-violet	Black
White	○	○	○	○	○	○	○	○	○	○	○	○
Red	○	○	○	○	○	○	○	○	○	○	○	○
Yellow-red	○	○	○	○	○	○	○	○	○	○	○	○
Yellow	○	○	○	○	○	○	○	○	○	○	○	○
Yellow-green	○	○	○	○	○	○	○	○	○	○	○	○
Green	○	○	○	○	○	○	○	○	○	○	○	○
Blue-green	○	○	○	○	○	○	○	○	○	○	○	○
Blue	○	○	○	○	○	○	○	○	○	○	○	○
Blue-violet	○	○	○	○	○	○	○	○	○	○	○	○
Violet	○	○	○	○	○	○	○	○	○	○	○	○
Red-violet	○	○	○	○	○	○	○	○	○	○	○	○
Black	○	○	○	○	○	○	○	○	○	○	○	○

A high-power white LED and a multi-RGB processing system combine to cover all RGB wavelengths, enabling easy and accurate detection of workpieces without having to use a different light source to match each one.

No Need to Select

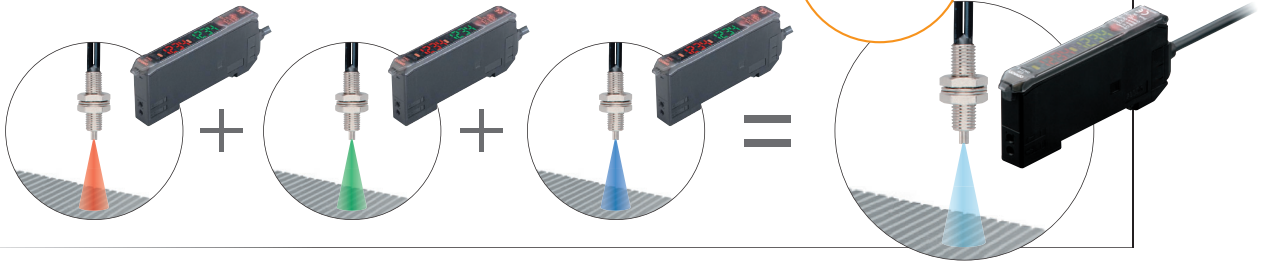

Changes in the three parameters are processed as a ratio, so they are not affected by light-intensity variations due to workpiece movement.

Resists Movement

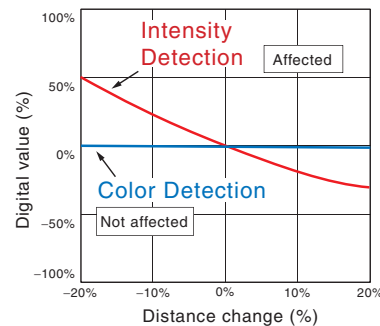
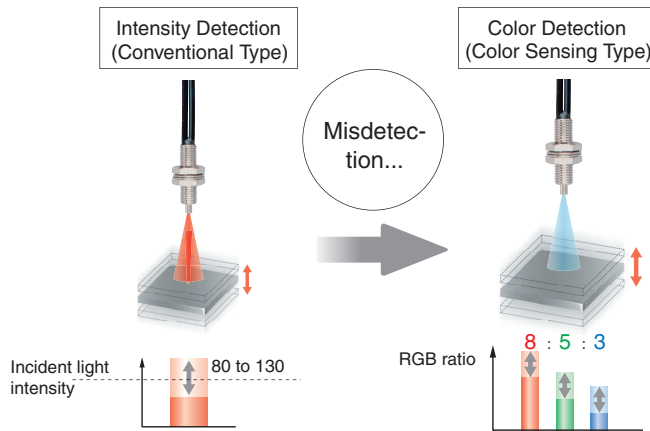

# Amplifier Unit

Thinnest in the Industry

## A Slim, 10-mm-wide Amplifier Unit

Use of a white LED and a one-package RGB light-receiving element has made it possible to unify the Amplifier Unit, both in size and operation, with conventional models. If detection should become unstable, the Amplifier Unit can be separately replaced to immediately regain stability.

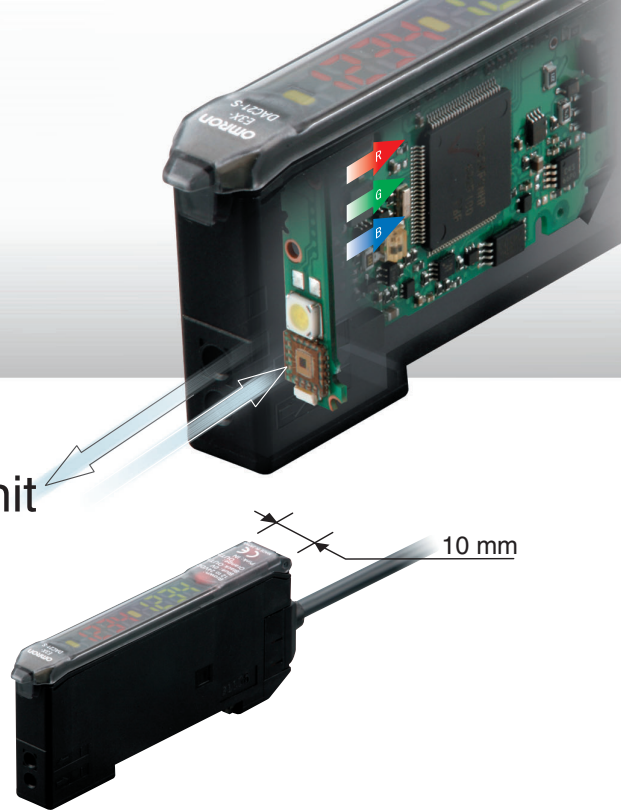

### Easy and Reliable ... Ease of Use and Smart Functions

In addition to ensuring easy use, we have added a number of smart functions, such as remote control to simplify setup, and twin sensing and output to simultaneously distinguish two registered colors. (advanced models)

First in Its Class

This function guides the user to ensure that the workpiece is in an appropriate position for teaching. (Indicates OVER, OK, or LOW.)

Reliable

Setting guide function.



Easy to Understand

A double display for easy, precise setting.

One push is all it takes.

Easy Setting

### Easy and Reliable ... Simplified Wiring Connector Reduces Work Steps

OMRON's unique simplified wiring connectors provide the power for each added Sensor. Up to 16 Units can be mounted, including a combination of Digital Fiber Sensors and other simplified wiring connector products such as Digital Laser Sensors.

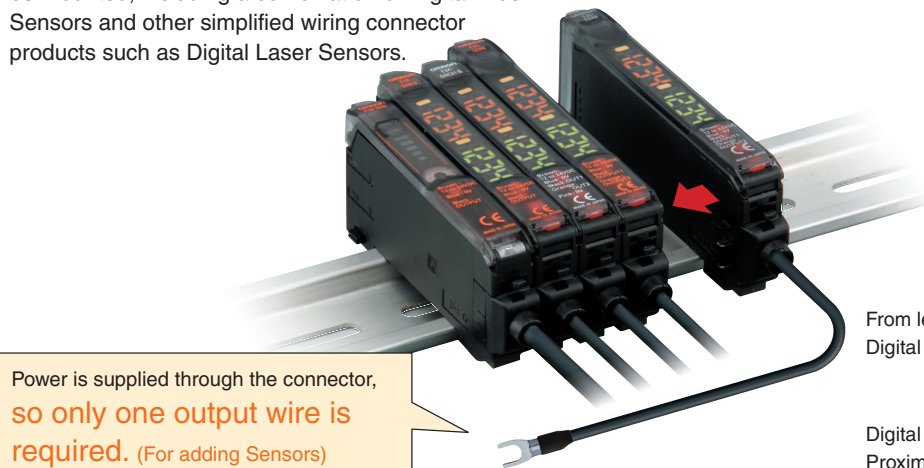

From left to right

- Digital Fiber Sensors: E3X-NA  
E3X-DA-S/MDA  
E3X-DAC-S
- Digital Laser Sensor: E3C-LDA
- Proximity Sensor: E2C-EDA

Power is supplied through the connector, so only one output wire is required. (For adding Sensors)

# Application



## Wide Range of Fiber Heads Available

Select from a wide range of Fiber Heads to match the workpiece and working space. This makes installation possible even in small spaces.

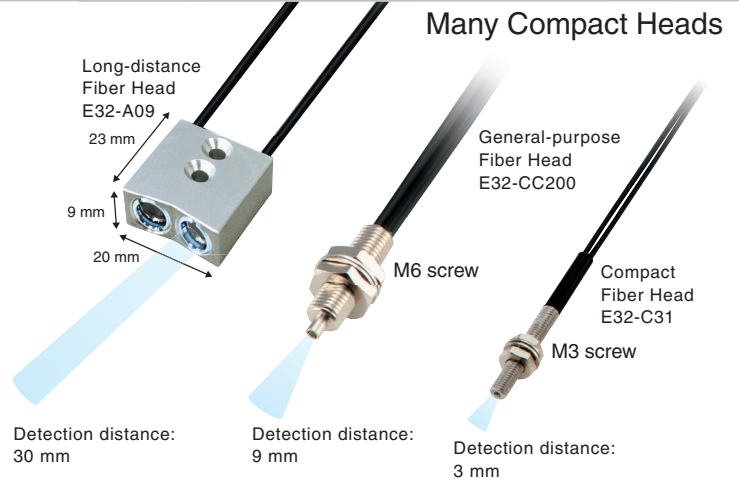

### Easy and Reliable Applications (Examples)

#### Detecting Marks

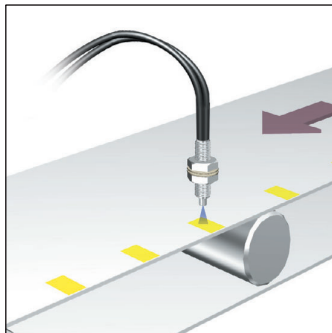

Because it distinguishes RGB ratios, detection is highly resistant to workpiece movement.

#### Distinguishing Semi-transparent Objects

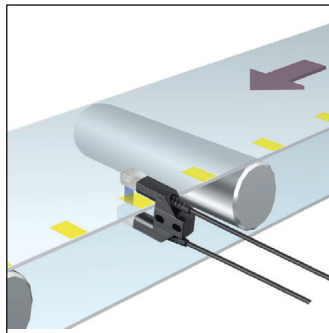

Through-beam Fiber Heads are capable of detecting color differences in semi-transparent objects.

#### Detecting Black Marks

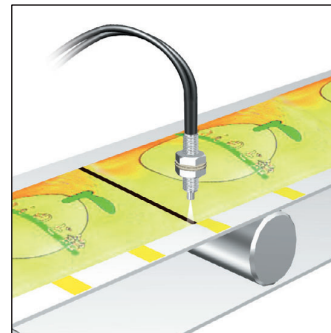

In Black Mode, black seam tape and other black marks can be detected regardless of film color or patterns.

#### Distinguishing Trays

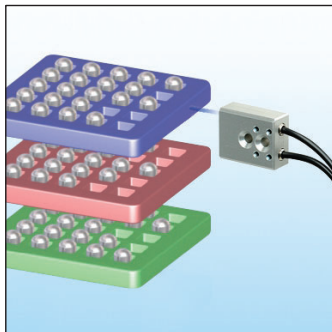

Twin sensing and remote control functions simplify setup.

#### Detecting Wafers

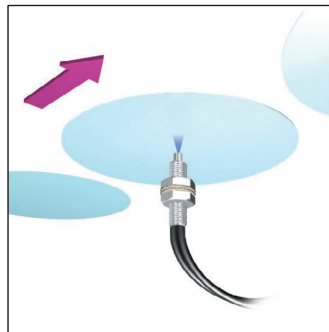

Workpieces that absorb a specific wavelength can be detected with a wide range of wavelengths.

#### Detecting Products on Conveyors

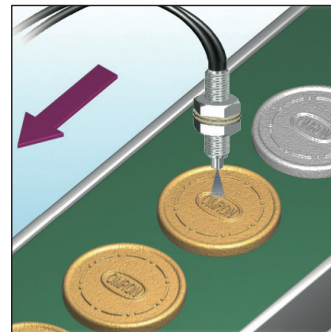

If you teach the conveyor (i.e., the background), you can detect workpieces even if they have different colors, shapes, or gloss.

## Ordering Information

### Amplifier Units



#### Amplifier Units with Cables

Item	Appearance	Functions	Model	
			NPN output	PNP output
Standard models		Timer, Response speed change	E3X-DAC11-S 2M	E3X-DAC41-S 2M
Advanced models		Standard models + Simultaneous determination (2 colors) AND/OR output, Remote setting	E3X-DAC21-S 2M	E3X-DAC51-S 2M

#### Amplifier Units with Connectors (Amplifier Unit Connectors must be purchased separately.)

Item	Appearance	Functions	Model	
			NPN output	PNP output
Standard models		Timer, Response speed change	E3X-DAC6-S	E3X-DAC8-S

#### Amplifier Unit Connectors (Order Separately) Note: Protector seals are provided as accessories.

Item	Appearance	Cable length	No. of conductors	Model
Master Connector		2 m	3	E3X-CN11
Slave Connector			1	E3X-CN12

Combining Amplifier Units and Connectors	Amplifier Unit			Applicable Connector (Order Separately)	
	Model	NPN output	PNP output	Master Connector	Slave Connector
	Standard models	E3X-DAC6-S	E3X-DAC8-S	+	E3X-CN11
<b>When Using 5 Amplifier Units</b>					
Amplifier Units (5 Units)				+	1 Master Connector 4 Slave Connectors

### Accessories (Order Separately)

#### Mounting Bracket

Appearance	Model	Quantity
	E39-L143	1

#### End Plate

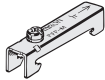
Appearance	Model	Quantity
	PFP-M	1

# E3X-DAC-S

## Ratings and Specifications

### Amplifier Units

Item	Type Model	Standard models	Advanced models
		E3X-DAC□-S□ (□: 11/41/6/8)	E3X-DAC□-S□ (□: 21/51)
Sensing distance		Depends on the Fiber Unit. Refer to pages 8 to 10.	
	Sensing object	Reflective models: Standard 11 color cards (See note 1.), Through-beam models: Opaque or translucent object	
Light source (wavelength)		White LED (420 to 700 nm)	
Sensing method		C Mode: RGB ratio determination (or I Mode: Light intensity determination for red, green, or blue, Black Mode: Determination of total light intensity for red, green, and blue) (See note 2.)	
	Number of registered colors	1	2 (simultaneous determination)
Power supply voltage		12 to 24 VDC ±10%, ripple (p-p) 10% max.	
Power consumption		960 mW max. (current consumption: 40 mA max. at power supply voltage of 24 VDC)	
Control output		NPN or PNP open collector Load power supply voltage: 26.4 VDC max. Load current: 50 mA max. (residual voltage: 2 V max.)	
Remote control input		---	No-voltage input (contact/transistor) (See note 3.)
Protection circuits		Reverse polarity for power supply connection, output short-circuit, Reversed output polarity protection	
Re- response time	Super-high-speed mode (See note 4.)	Operate or reset: 60 μs	Operate or reset: 120 μs
	High-speed mode	Operate or reset: 300 μs	Operate or reset: 600 μs
	Standard mode	Operate or reset: 1 ms	Operate or reset: 2 ms
	High-resolution mode	Operate or reset: 4 ms	Operate or reset: 8 ms
Sensitivity setting (color registration, allowable range)		Teaching (one-point teaching or teaching with/without workpiece) or manual adjustment	
Func- tions	Operating mode	ON for match (ON for same color as registered color) or ON for mismatch (ON for different color from registered color)	
	Timer function	Timer type: OFF delay, ON delay, or one-short Timer time: 1 ms to 5 s (variable)	
	Control outputs	---	Output for each channel, AND output, and OR output
	Remote control	---	One-point teaching, teaching with/without workpiece, zero reset, and light emission OFF
	Display switch (See note 5.)	Seven patterns total: Match + Threshold, Margin + Threshold, Analog bar display, Peak + Bottom, etc.	
	Initialization	Initial reset (factory defaults) or user reset (saved settings)	
Display		Operation indicator (orange)/ I mode display indicator (orange)	Channel 1 and channel 2 operation indicators (orange)
Digital display		7-segment displays (Main display: Red, Sub-display: Green), display direction can be reversed.	
Ambient illumination (Receiver side)		Incandescent lamp: 3,000 lux Sunlight: 10,000 lux	
Ambient temperature range (See note 6.)		Operating: -25°C to 55°C Storage: -30°C to 70°C (with no icing or condensation)	
Ambient humidity range		Operating and storage: 35% to 85% (with no condensation)	
Insulation resistance		20 MΩ min. (at 500 VDC)	
Dielectric strength		1,000 VAC at 50/60 Hz for 1 minute	
Vibration resistance		Destruction: 10 to 50 Hz with a 1.5-mm double amplitude for 2 hrs each in X, Y and Z directions	
Shock resistance		Destruction: 500 m/s <sup>2</sup> , for 3 times each in X, Y and Z directions	
Degree of protection		IEC 60529 IP50 (with Protective Cover attached)	
Connection method		Pre-wired or Amplifier Unit Connector (Units connected: 16 max.)	Pre-wired
Weight (packed state)		Pre-wired model: Approx. 100 g, Amplifier unit connector model: Approx. 55 g	
Materi- als	Case	Polybutylene terephthalate (PBT)	
	Cover	Polycarbonate (PC)	
Accessories		Instruction manual	

Note: 1. Sensing Object: Standard Color Card (230 Colors) from Japan Color Enterprise Co., Ltd.)

Color (11 standard colors)	Munsell color notation
White	N9.5
Red	4R 4.5/12.0
Yellow/red	4YR 6.0/11.5
Yellow	5Y 8.5/11.0
Yellow/green	3GY 6.5/10.0
Green	3G 6.5/9.0
Blue/green	5BG 4.5/10.0
Blue	3PB 5.0/10.0
Blue/purple	9PB 5.0/10.0
Purple	7P 5.0/10.0
Red/purple	6RP 4.5/12.5
Black	(N2.0)

2. When teaching with/without a workpiece, the best sensing method will be automatically selected (RGB ratio (C Mode) or light intensity determination (I Mode)). If color differences are not strong enough and RGB ratios would result in unstable detection, then light intensity determination (I Mode) will be selected.

The detection mode can also be set to C, I, or Black Mode.

### 3. Input Specifications

	Contact input (relay or switch)	Non-contact input (transistor)
<b>NPN</b>	ON: Shorted to 0 V (sourcing current: 1 mA max.). OFF: Open or shorted to Vcc.	ON: 1.5 V max. (sourcing current: 1 mA max.) OFF: Vcc - 1.5 V to Vcc (leakage current: 0.1 mA max.)
<b>PNP</b>	ON: Shorted to Vcc (sinking current: 3 mA max.). OFF: Open or shorted to 0 V.	ON: Vcc - 1.5 V to Vcc (sinking current: 3 mA max.) OFF: 1.5 V max. (leakage current: 0.1 mA max.)

- Mutual interference prevention cannot be used in super-high-speed mode, and light intensity determination (I Mode) must be used.
- With light intensity determination (I Mode), the correlation is not displayed, but rather the light intensity is displayed.
- The allowable ambient operating temperature changes according to the number of Units that are linked.  
2 Units: -25 to 55°C, 3 to 10 Units: -25 to 50°C, and 11 to 16 Units: -25 to 45°C

### Amplifier Unit Connectors

Item	Model	E3X-CN11	E3X-CN12
Rated current		2.5 A	
Rated voltage		50 V	
Contact resistance		20 mΩ max. (20 mVDC max., 100 mA max.) (The figure is for connection to the Amplifier Unit and the adjacent Connector. It does not include the conductor resistance of the cable.)	
No. of insertions		Destruction: 50 times (The figure for the number of insertions is for connection to the Amplifier Unit and the adjacent Connector.)	
Materials	Housing	Polybutylene terephthalate (PBT)	
	Contacts	Phosphor bronze/gold-plated nickel	
Weight (packed state)		Approx. 55 g	Approx. 25 g

# E3X-DAC-S

Sensing Distance  
Reflective Models

(Unit: mm)

Type		Sensing object	White paper				Standard color card (11 colors) (mutual determination)			
			High-resolution mode	Standard mode	High-speed mode	Super-high-speed mode	High-resolution mode	Standard mode	High-speed mode	Super-high-speed mode
Standard models	General-purpose	E32-DC200	70	54	46	18	14	10	8.5	6
		E32-D11R/E32-D12R/ E32-D15XR/E32-D11N/ E32-DC200BR (B4R)	42	32	26	11	8.5	6	5	3.5
		E32-D14LR	11	8.5	7	2.5	2.4	1.7	1.4	1
		E32-D15YR/E32-D15ZR	10	7.5	6.5	2.5	2.1	1.5	1.3	0.9
		E32-D211/E32-DC200E/ E32-D22/E32-D25X/ E32-DC200F (F4)	20	16	14	5	4.5	3	2.5	1.5
		E32-D24	8.8	6.7	5.8	2.1	1.8	1.3	1.1	0.7
		E32-D25Y/E32-D25Z	5.8	4.5	3.8	1.4	1.2	0.9	0.7	0.5
	Break-resistant	E32-D11/E32-D15XB	42	32	26	11	8.5	6	5	3.5
		E32-D21B/E32-D221B	19	15	13	4.5	4.1	3	2.4	1.5
		E32-D21/E32-D22B	8.8	6.7	5.8	2.1	1.8	1.3	1.1	0.7
		E32-D25XB	14	10	9	3	3	2.1	1.7	1.1
	Fluorine coating	E32-D11U	42	32	26	11	8.5	6	5	3.5
	Special-beam models	Long-distance, high power	E32-A09	20 to 38	24 to 36	26 to 32	---	20 to 38	24 to 36	26 to 32
E32-D11L			90	70	60	22	19	13	11	7.5
E32-D21L/E32-D22L			35	26	22	8	7	5	4	2.5
Coaxial		E32-CC200	60	45	35	16	12	9	7	4
		E32-CC200R/E32-C11N	35	26	22	9	7.5	5	4.5	3
		E32-D32L	35	26	22	9	7.5	5	4.5	3
		E32-C31/E32-D32	17	13	11	4.5	3.7	2.7	2.2	1.5
E32-C31N		7.7	6	4.8	2.1	1.6	1.2	0.9	0.7	
Area sensing	E32-D36P1	35	26	22	9	7.5	5	4.5	3	
Environment resistive models	Heat-resistant	E32-D51	55	42	36	14	11	8.5	7	4.5
		E32-D81R-S/E32-D61-S	20	15	13	5	4	3	2.5	1.5
		E32-D73-S	13	10	8.5	3.5	2.8	2	1.7	1.2
	Chemical resistant	E32-D12F	22	17	15	6	4.9	3.5	2.9	2
		E32-D14F	9	7	6	2	2.1	1.4	1.2	0.6



## Through-beam Models

(Unit: mm)

Sensing object			Opaque object				Translucent object (See note.)				
			High-resolution mode	Standard mode	High-speed mode	Super-high-speed mode	High-resolution mode	Standard mode	High-speed mode	Super-high-speed mode	
Standard models	General-purpose	E32-TC200	200	160	140	70	45	32	26	22	
		E32-T11R/E32-T12R/ E32-T15XR/E32-T11N/ E32-TC200BR (B4R)	150	110	95	50	30	22	18	16	
		E32-T14LR/E32-T15YR/ E32-T15ZR	55	44	38	19	12	8.5	7	6.5	
		E32-TC200E/E32-T22/ E32-T222/E32-T25X/ E32-TC200F (F4)	80	60	50	46	17	12	10	7	
		E32-T24/E32-T25Y/ E32-T25Z	48	36	32	26	10	7	6	4	
	Break-resistant	E32-T11/E32-T12B/ E32-T15XB	190	140	120	60	40	28	24	20	
		E32-T21/E32-T221B/ E32-T22B	70	55	48	40	15	11	9	6	
		E32-T25XB	55	42	36	30	11	8	7	4.5	
	Fluorine coating	E32-T11U	190	140	120	60	40	28	24	20	
	Special-beam models	Long-distance, high power	E32-T17L	4300	3200	2800	1400	900	600	500	460
			E32-TC200+E39-F1	1100	850	700	360	220	160	140	120
E32-T11R+E39-F1 E32-T11N+E39-F1			1000	750	650	340	220	150	130	110	
E32-T11+E39-F1			1000	750	650	320	200	150	120	110	
E32-T14			950	700	600	300	200	140	120	100	
E32-T11L/E32-T12L			350	250	200	120	75	55	46	40	
E32-T11L+E39-F2			220	160	140	75	46	32	28	25	
E32-T11R+E39-F2			110	85	70	36	22	16	14	12	
E32-T11+E39-F2			180	140	120	60	38	28	22	20	
E32-T12L/E32-T22L		160	120	100	90	34	24	20	14		
Fine beam		E32-T22S	500	400	350	170	110	80	65	55	
		E32-T24S	360	280	240	120	75	55	46	40	
Area sensing		E32-T16	750	600	500	250	160	110	95	85	
		E32-T16PR	240	180	150	80	50	36	30	26	
		E32-T16JR	200	160	130	65	44	30	26	22	
		E32-T16WR	360	280	240	120	75	55	46	40	
Label detection (Slot Sensor)		E32-G14	10				10				

\* These sensing distances are recommended to make the most of the detection capabilities of the Sensor.

# E3X-DAC-S

Type		Sensing object	Opaque object				Translucent object (See note.)			
			High-resolution mode	Standard mode	High-speed mode	Super-high-speed mode	High-resolution mode	Standard mode	High-speed mode	Super-high-speed mode
Environment resistant models	Heat-resistant	E32-T51	200	160	140	70	44	32	26	22
		E32-T54	60	48	42	20	13	9.5	8.1	7
		E32-T81R-S	75	60	50	26	16	11	9.5	8.5
		E32-T61-S	120	95	80	42	26	19	16	14
		E32-T61-S+E39-F1	950	700	600	320	200	140	120	100
		E32-T61-S+E39-F2	120	95	80	42	26	19	16	14
	Chemical resistant	E32-T84S-S	360	280	240	120	75	55	46	40
		E32-T11F	550	420	360	180	110	80	70	60
		E32-T12F	850	650	550	280	180	120	100	95
		E32-T14F	100	80	70	35	22	16	13	12
		E32-T51F	380	300	250	130	80	55	48	44
	Vacuum resistant	E32-T81F-S	190	150	120	65	40	28	24	22
		E32-T51V	55	42	36	18	11	8.5	7	6
		E32-T51V+E39-F1V	280	200	180	90	55	42	35	30
		E32-T54V	36	28	24	12	7.5	5.5	4.5	4
		E32-T54V+E39-F1V	140	100	90	46	28	20	17	15
			E32-T84SV	130	100	85	45	28	20	17

\* These sensing distances are recommended to make the most of the detection capabilities of the Sensor.

Refer to the *E32 Series Fiber Sensor Best Selection Guide (Cat. No. E353)*.

Engineering Data (Typical)

Color vs. Detection Capability

E3X-DAC□-S+E32-CC200

	White	Red	Yellow/red	Yellow	Yellow/green	Green	Blue/green	Blue	Blue/purple	Purple	Red/purple	Black*
White		○	○	○	○	○	○	○	○	○	○	○
Red	○		○	○	○	○	○	○	○	○	○	○
Yellow/red	○	○		○	○	○	○	○	○	○	○	○
Yellow	○	○	○		○	○	○	○	○	○	○	○
Yellow/green	○	○	○	○		○	○	○	○	○	○	○
Green	○	○	○	○	○		○	○	○	○	○	○
Blue/green	○	○	○	○	○	○		○	○	○	○	○
Blue	○	○	○	○	○	○	○		○	○	○	○
Blue/purple	○	○	○	○	○	○	○	○		○	○	○
Purple	○	○	○	○	○	○	○	○	○		○	○
Red/purple	○	○	○	○	○	○	○	○	○	○		○
Black*	○	○	○	○	○	○	○	○	○	○	○	

Sensing distance: 9 mm (i.e., the teaching distance)  
 ○: Detection possible, ×: Detection not possible.  
 \* Use 2-point teaching to distinguish between white and black.

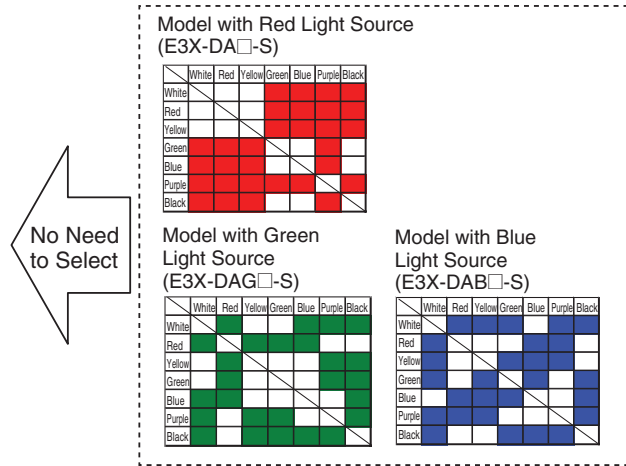

Color Detection Characteristics

E3X-DAC□-S+E32-CC200

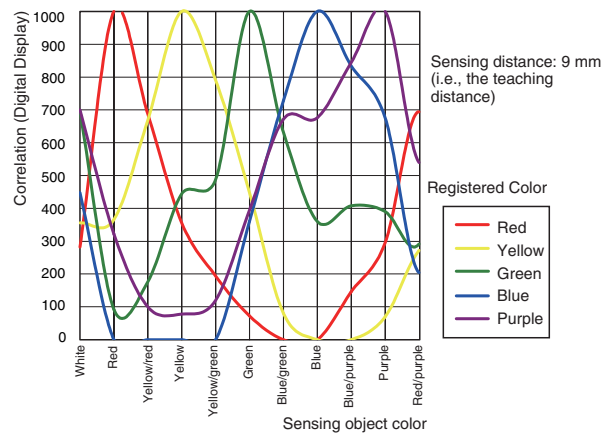

Color Detection Capability vs. Distance

E3X-DA□-S+E32-CC200

E3X-DAB/G□-S+E32-CC200 (Model with single-color light source)

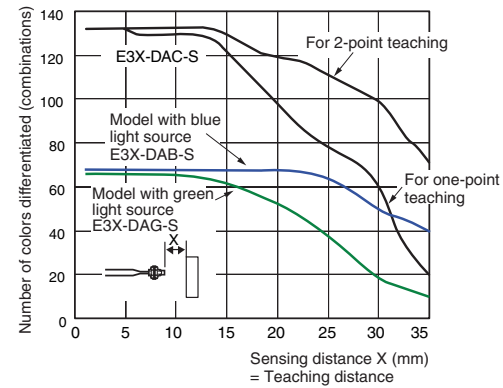

Correlation vs. Distance

E3X-DAC□-S+E32-CC200

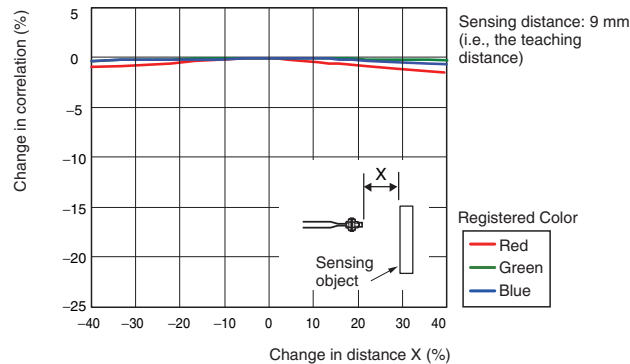

Correlation vs. Angle

E3X-DAC□-S+E32-CC200

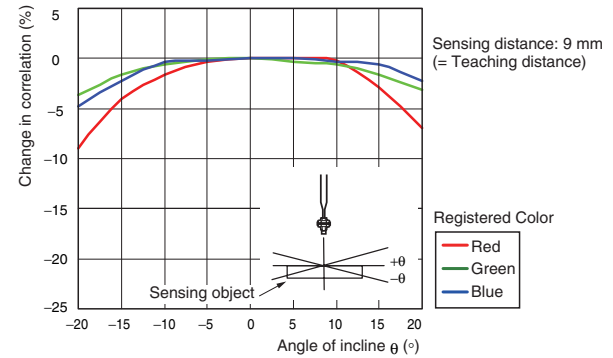

# E3X-DAC-S

## Output Circuit Diagrams

### NPN Output

Model	Operation mode	Timing charts	Operation selector	Output circuit
E3X-DAC11-S E3X-DAC6-S	ON for match	<p>(Between brown and black leads)</p>	LIGHT ON (L-ON)	
	ON for mismatch	<p>(Between brown and black leads)</p>	DARK ON (D-ON)	
E3X-DAC21-S	ON for match	<p>(Between brown and black leads)</p>	LIGHT ON (L-ON)	
	ON for mismatch	<p>(Between brown and black leads)</p>	DARK ON (D-ON)	

### PNP Output

Model	Operation mode	Timing charts	Operation selector	Output circuit
E3X-DAC41-S E3X-DAC8-S	ON for match	<p>(Between blue and black leads)</p>	LIGHT ON (L-ON)	
	ON for mismatch	<p>(Between blue and black leads)</p>	DARK ON (D-ON)	
E3X-DAC51-S	ON for match	<p>(Between blue and black leads)</p>	LIGHT ON (L-ON)	
	ON for mismatch	<p>(Between blue and black leads)</p>	DARK ON (D-ON)	

Note:1. Timing Charts for Timer Function Settings (T: Set Time)

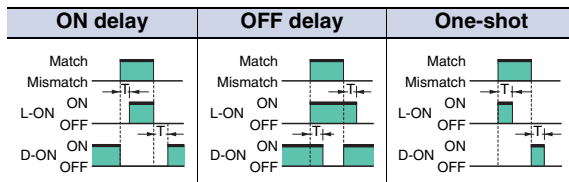

2. Control Output (AND, OR, Sync) and Timing Chart for Timer Settings (T: Set Time)

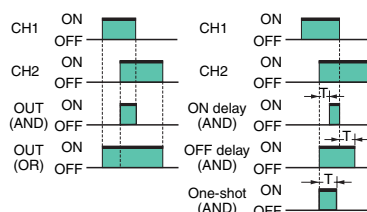

## Nomenclature

### Amplifier Units

#### Standard Models

E3X-DAC□-S (□: 11/41/6/8)

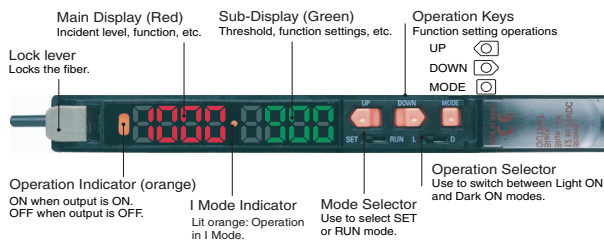

#### Advanced Models

E3X-DAC□-S (□: 21/51)

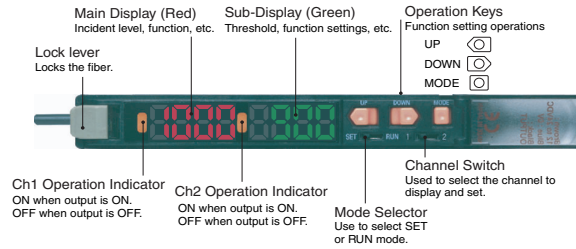

## Safety Precautions

### ⚠ WARNING

This product is not designed or rated for ensuring safety of persons either directly or indirectly.



Do not use it for such purposes.

### ⚠ CAUTION

Do not use the product with voltage in excess of the rated voltage. Excess voltage may result in malfunction or fire.



Never use the product with an AC power supply. Otherwise, explosion may result.



High-temperature environments may result in burn injury.



### Precautions for Safe Use

The following precautions must be observed to ensure safe operation of the Sensor.

1. Do not use the Sensor in an environment where explosive or flammable gas is present.
2. Do not use the Sensor in a location subject to splattering of water, oils, or chemicals.
3. Do not attempt to disassemble, repair, or modify the Sensor.
4. Do not apply voltages or currents that exceed the rated range to the Sensor.
5. Do not use the Sensor in an ambient atmosphere or environment that exceeds the ratings.
6. Wire the power supply correctly, including the polarity.
7. Connect the load correctly.
8. Do not short-circuit the load at both ends.
9. Do not use the Sensor if the case is damaged.
10. Dispose of the Sensor as industrial waste.
11. Do not use the Sensor in locations subject to direct sunlight.
12. Burn injury may occur. The Sensor surface temperature rises depending on application conditions, such as the ambient temperature and the power supply voltage. Use caution when operating or performing maintenance on the Sensor.

## Precautions for Correct Use

Do not use the product in atmospheres or environments that exceed product ratings.

### Amplifier Unit

#### ● Designing

#### Operation after Turning Power ON

The Sensor is ready to detect within 200 ms after the power supply is turned ON. If the Sensor and load are connected to separate power supplies, be sure to turn ON the Sensor first. Time may be required for the incident level to stabilize after the power supply is turned ON.

#### Operation When Turning Power OFF

Output pulses may occur when the power is turned OFF. Turn OFF the power supply to the load and the load line before turning OFF the power supply to the Sensor.

#### ● Mounting

### Connecting and Disconnecting Connectors

#### Mounting Connectors

1. Insert the Master or Slave Connector into the Amplifier Unit until it clicks into place.

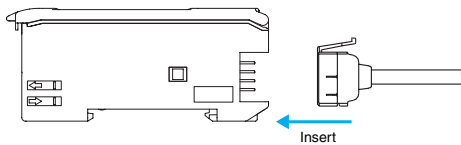

2. Attach the protector seals (provided as accessories) to the sides of master and slave connectors that are not connected.

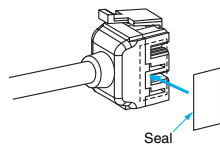

Note: Attach the seals to the sides with grooves.

#### Removing Connectors

1. Slide the slave Amplifier Unit(s) for which the Connector is to be removed away from the rest of the group.
2. After the Amplifier Unit(s) has been separated, press down on the lever on the Connector and remove it. (Do not attempt to remove Connectors without separating them from other Amplifier Units first.)

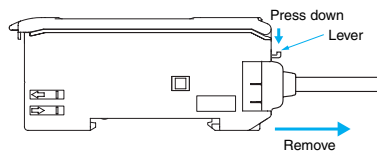

### Adding and Removing Amplifier Units

#### Adding Amplifier Units

1. Mount the Amplifier Units one at a time onto the DIN track.

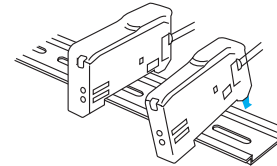

2. Slide the Amplifier Units together, line up the clips, and press the Amplifier Units together until they click into place.

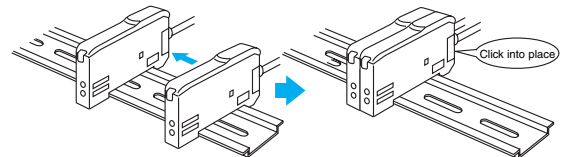

#### Removing Amplifier Units

Slide Amplifier Units away from each other, and remove from the DIN track one at a time. (Do not attempt to remove Amplifier Units from the DIN track without separating them first.)

Note: 1. The specifications for ambient temperature will vary according to the number of Amplifier Units used together. For details, refer to *atings and Specifications*.  
2. Always turn OFF the power supply before joining or separating Amplifier Units.

#### Mounting the End Plate (PFP-M)

An End Plate should be used if there is a possibility of the Amplifier Unit moving, e.g., due to vibration.

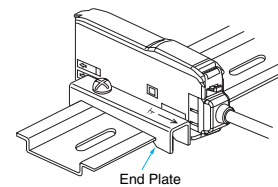

#### Fiber Connection

The E3X Amplifier Unit has a lock button for easy connection of the Fiber Unit. Connect or disconnect the fibers using the following procedures:

#### 1. Connection

Open the protective cover, insert the fibers according to the fiber insertion marks on the side of the Amplifier Unit, and lower the lock lever.

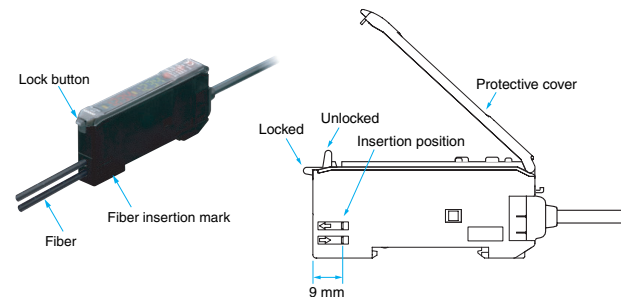

Note: Do not pull on, compress, or otherwise exert excessive force on the fibers after connecting them to the Amplifier Unit. (Do not exert more than 0.3 N·m.)

## 2. Disconnecting Fibers

Remove the protective cover and raise the lock lever to pull out the fibers.

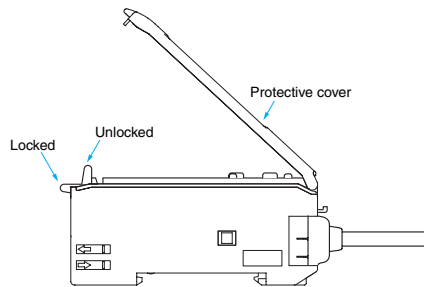

Note: 1. To maintain the fiber properties, confirm that the lock is released before removing the fibers.  
2. Be sure to lock or unlock the lock button within an ambient temperature range between  $-10^{\circ}\text{C}$  and  $40^{\circ}\text{C}$ .

### ● Adjusting

#### Mutual Interference Protection Function

Light from other sensors can cause the value on the digital display to become somewhat unstable. If this occurs, reduce the threshold to create a greater margin and enable more stable detection.

#### Shorting the Output

If the output short-circuit function operates because the load connected to the control output is short-circuited, OVER/CUR will flash on the display. Check the connection of the load.

#### EEPROM Writing Error

If the data is not written to the EEPROM correctly due to a power failure or static-electric noise, initialize the settings with the keys on the Amplifier Unit. ERR/EOP will flash on the display when a writing error has occurred.

#### Optical Communications

Several Amplifier Units can be slid together and used in groups. Do not, however, slide the Amplifier Units or attempt to remove any of the Amplifier Units during operation.

### ● Others

#### Protective Cover

Always keep the protective cover in place when using the Amplifier Unit.

## Fiber Unit

### ● Design Precautions

#### Applicable Fiber Units

Refer to the sensing distance tables on pages 8 to 10 for the Fiber Units that can be used and the sensing distances. Retro-reflective, Limited-reflective, Ultra-compact, and Application-specific Fiber Units, which are not listed, cannot be used.

### ● Installation Precautions

#### Glossy Sensing Objects

If the sensing object is glossy, detection may not be stable. If the Sensor is inclined by  $5^{\circ}$  to  $20^{\circ}$  when using a glossy sensing object, as shown below, detection capabilities can be increased and stable detection achieved.

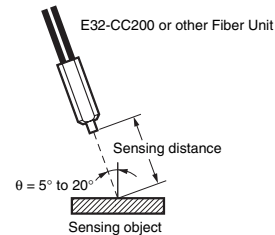

# E3X-DAC-S

## Dimensions

(Unit: mm)

### Amplifier Units

#### Amplifier Units with Cables

- E3X-DAC11-S
- E3X-DAC41-S
- E3X-DAC21-S
- E3X-DAC51-S

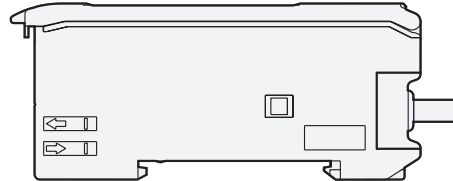
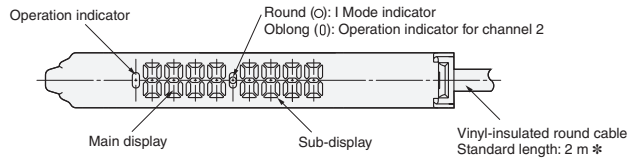

\* Cable Specifications

<b>E3X-DAC11-S -DAC41-S</b>	4-dia., 3-conductor (Conductor cross section: 0.2 mm <sup>2</sup> , insulator diameter: 1.1 mm)
<b>E3X-DAC21-S -DAC51-S</b>	4-dia., 5-conductor (Conductor cross section: 0.2 mm <sup>2</sup> , insulator diameter, 1.1 mm)



#### With Mounting Bracket Attached

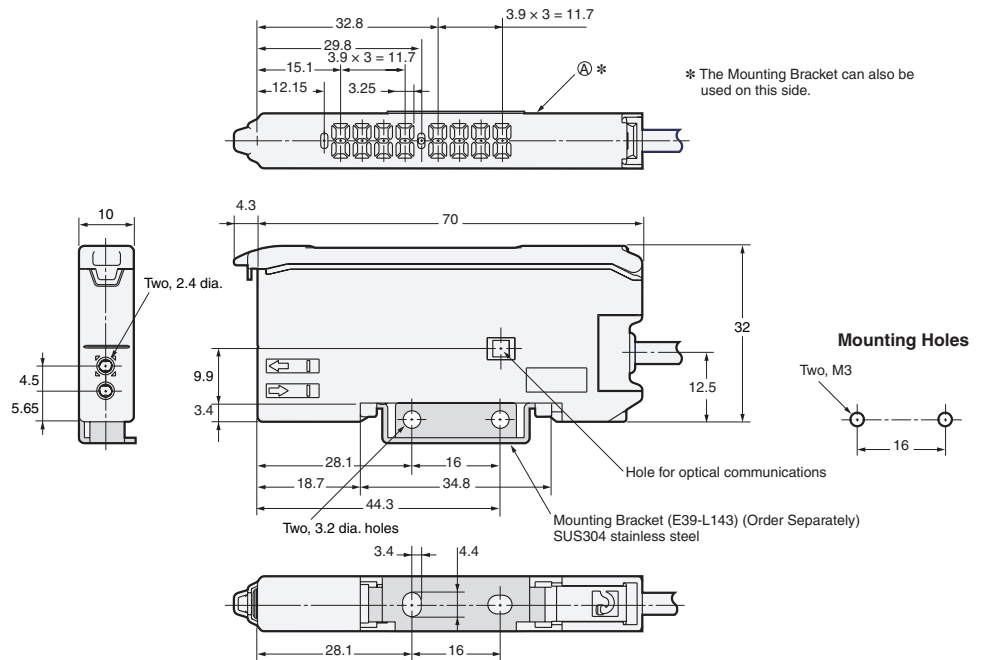



## Amplifier Units with Connectors

E3X-DAC6-S  
E3X-DAC8-S

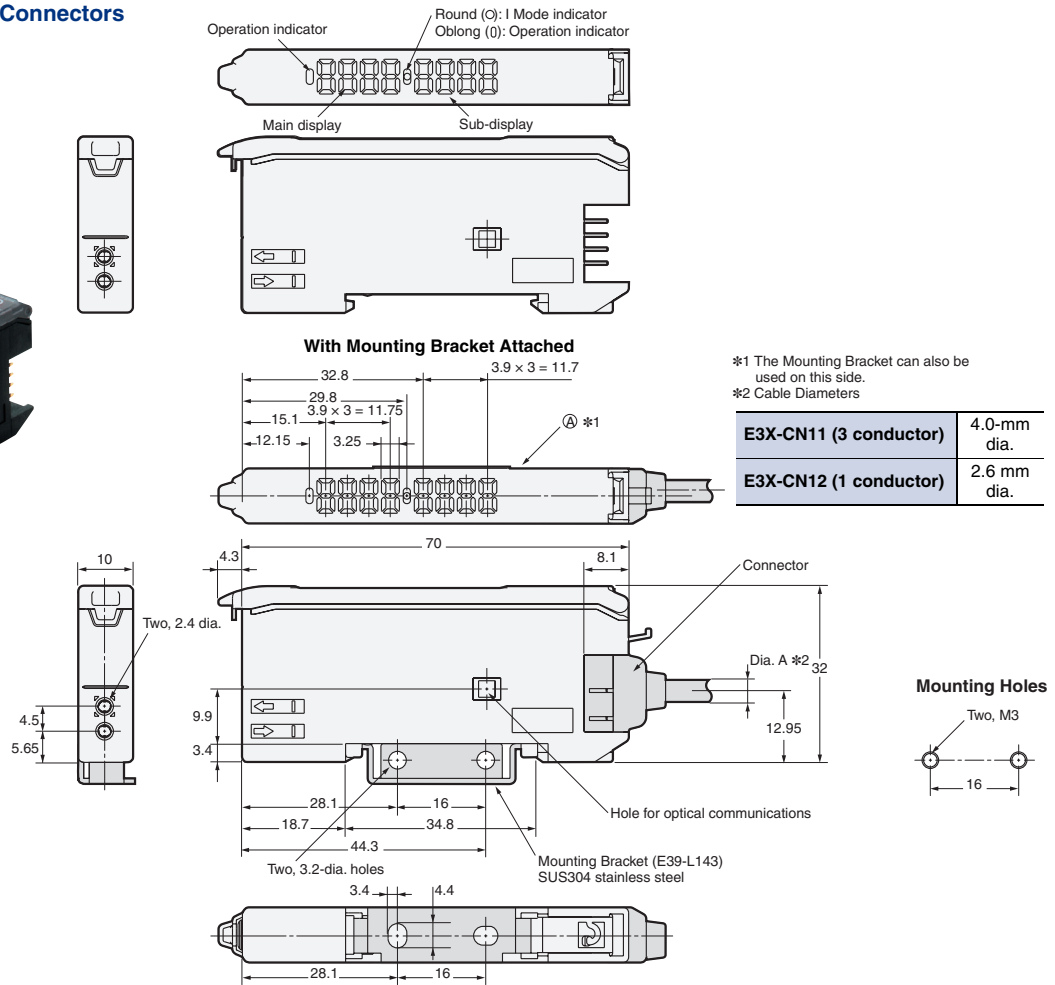

## Amplifier Unit Connectors

### Master Connectors

E3X-CN11

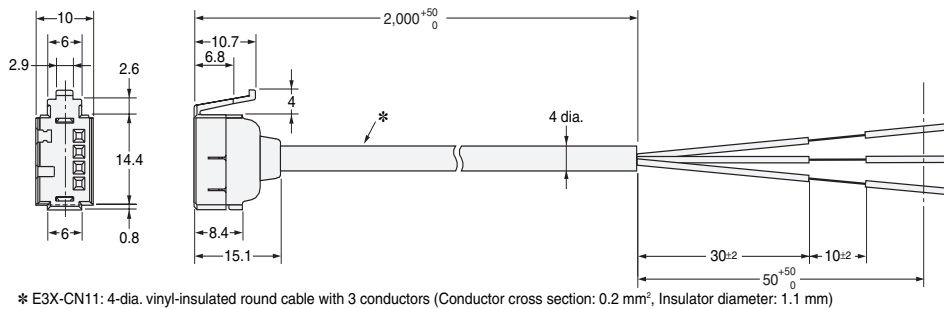
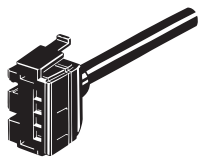

### Slave Connectors

E3X-CN12

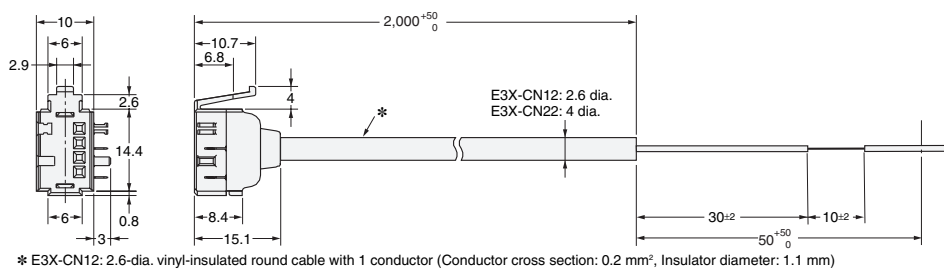
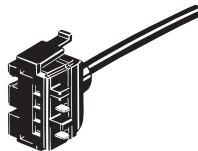

Refer to the *E32 Series Fiber Sensor Best Selection Guide* (Cat. No. E353).

# E3X-DAC-S

## Operation

### Operation Reference

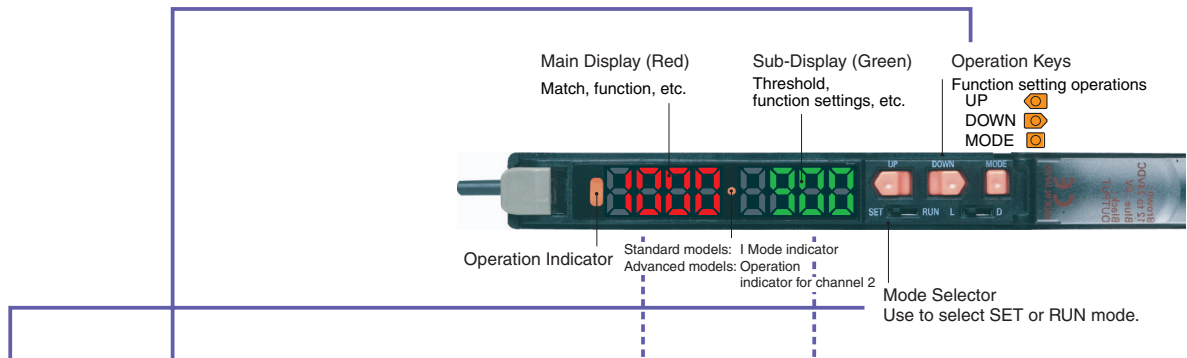

SET/RUN mode	Operation Keys	Operation	Displays		Remarks
			Main Display	Sub-Display	
RUN (Factory-set to RUN)	/  	Adjusting thresholds	Incident level	Threshold	<b>→ Page 19</b> Refer to <b>3. Setting Thresholds Manually in RUN Mode.</b>
		Executing user-specified functions (Factory-set to 1-point teaching.)			Used to execute various teaching and zero-reset operations. <b>→ Page 19</b> Refer to <b>2. Registering Work-piece Colors with Teaching in SET Mode.</b>
SET 	/  	Changing teaching and setting details	Setting items	Setting details	<b>→ Page 19</b> Refer to <b>2. Registering Work-piece Colors with Teaching in SET Mode.</b>  <b>→ Page 20</b> Refer to <b>4. Setting Functions in SET Mode.</b>
		Switching setting items	  	  	

SET/RUN mode	Operation Keys	Operation	Display		Remarks
			Main Display	Sub-Display	
RUN (Factory-set to RUN)	+	Locking and unlocking keys	LOC 	ON 	Locks key operation to prevent incorrect operation. <b>→ Page 21</b> Refer to <b>5. Convenient Functions.</b>
SET 	+	Initialization and user reset	INIT 	YES? 	Returns the system to its initial state. <b>→ Page 21</b> Refer to <b>5. Convenient Functions.</b>

### 1 Setting the Operation Mode

The operation mode is set with the Mode Selector.

Operation mode		Operation
Match ON	L-ON	L <span style="border: 1px solid black; display: inline-block; width: 20px; height: 10px;"></span> (Factory-set)
Mismatch ON	D-ON	<span style="border: 1px solid black; display: inline-block; width: 20px; height: 10px;"></span> D

\* Advanced Models  
The operation mode is set in SET mode.  
→ Page 20 Refer to 4. **Setting Functions in SET Mode.**

\* Advanced Models  
Set the Channel Selector to the desired channel before making any adjustments or settings. This is true for all adjustments and settings.

### 2 Registering Workpiece Colors with Teaching in SET Mode

\* Workpiece colors must always be taught to perform judgment for registered workpiece colors.  
\* With the factory settings, 1-point teaching can be executed in RUN mode. (Press the MODE Key for 3 s.)

### 2-1. One-point Teaching

Along with registering the workpiece colors, the threshold can be set at approximately –10% of the match. The setting is completed in a simple operation with one press of a button.

\* The threshold level can be changed if the teaching level function is used in SET mode.  
\* If BLACK mode is selected as the judgment mode in SET mode, the threshold will be set to a level of approximately 10% higher than the displayed degree of matching.

### 2-2. Teaching with and without the Workpiece

Two points, with and without the workpiece, are detected, and the match of the intermediate point is set as the threshold value. This method is ideal for setting thresholds with margins or performing judgments with low match.

\* When teaching is performed, position the workpiece by using the OVER, OK, and LO messages displayed on the sub-display (green) as guides.

- oT Ech o uEr OVER : Move the workpiece away.
- oT Ech o K OK : Teaching is possible.
- oT Ech o L Lo LO : Move the workpiece closer.

\* When teaching is performed, position the workpiece by using the OVER, OK, and LO messages displayed on the sub-display (green) as guides.

- oT Ech o uEr OVER : Move the workpiece away.
- oT Ech o K OK : Teaching is possible.
- oT Ech o L Lo LO : Move the workpiece closer.

### 3 Setting Thresholds Manually in RUN Mode

A threshold can be set manually. A threshold value can also be fine-tuned using manual setting after teaching.

Increases threshold. Decreases threshold.

\* Even if the display method for the Display Switch Function is changed, the threshold will appear on the sub-display when the key is pressed.

## 4 Setting Functions in SET Mode

### Function Transitions

→ Page 19  
Refer to 2. *Registering Workpiece Colors with Teaching in SET Mode.*

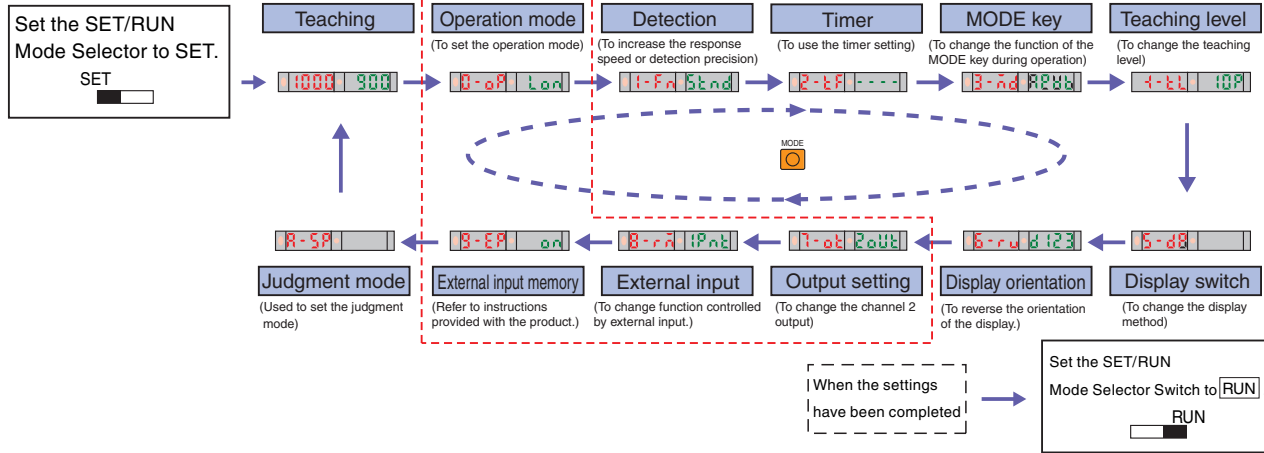

- \* The displays shown in the function transitions are for the default settings.
- \* Items shown in the function transitions may increase depending on detailed settings.
- \* The items enclosed by dotted red lines are for advanced models only.

### Functions

Use the UP and DOWN Keys to change the settings.

Function	Settings (display)	Description
Operation mode	Match: ON Lon, Mismatch: don	→ Page 19 Refer to 1. <i>Setting the Operation Mode.</i>
Detection	Super-high-speed: HSS, High-speed: HS, Standard: 5tnd, High-resolution: HRES Note: If the detection function is changed, be sure to teach the workpiece color.	Used to increase the response speed or detection precision. Note: Only I Mode (light intensity determination for red, green, or blue) can be used with Super-high-speed mode.
Timer	Enabled: 1-1-1-1, OFF-delay timer: oFFd ON-delay timer: on-d, One-shot timer: tShk	Used to set control output timers.
Timer time (timer enabled)	1 to 5000 ms: 1 to 5000 (1 to 20: 1-ms increments, 20 to 200 ms: 5-ms increments, 200 to 1000: 100-ms increments, 1000 to 5000: 1000-ms increments)	Used to change timer times. The timer can be set from 1 ms to 5 s.
MODE key	1-point teaching: 1Pnk, Teaching with workpiece: 2Pnk Zero-shift reset: 0r5k → Page 21 Refer to 5-1. <i>Zeroing the Display (Zero Reset).</i>	Used to change the function of the MODE key during operation.
Teaching level	0 to 99P: 0 to 99	Used to change the threshold setting level during 1-point teaching. (Example: The threshold level at the default setting (10) is 900. When the setting is 20, the threshold level is 800.)
Display switch	(1) Match/threshold: 050 500 (2) Margin/threshold: P123 500 (3) Peak/Bottom refreshed every 2 s: PERM botd (4) Peak/Bottom refreshed every time the output is switched: L-PE B-BB (5) Analog bar display: HHHH (6) Match/peak (updated periodically): 050 PERM (7) Match/channel: 050 2ch	1. Used to display the degree of matching and the threshold. 2. Used to display the excess gain (i.e., percentage of matching relative to threshold) and the threshold. 3. Used to display the peak and bottom degrees of matching at a fixed interval. 4. Used to display the peak degree of matching when there is a match and the bottom degree of matching when there is no match. 5. Used to show the detection status with a bar display. Red bars will be displayed if the degree of match exceeds the threshold. 6. Used to display the present degree of matching and the peak degree of matching. 7. Used to display the degree of matching and channel number.
Display orientation	Normal display: d123, Upside down display: E21P	Used to change the orientation of the display.
Output setting	Each channel: 200t, AND: And, OR: or	Used to change the item output on control output 2.
Timer function	Enabled: 1-1-1-1, OFF-delay timer: oFFd ON-delay timer: on-d, One-shot timer: tShk	Used to set timers for the AND/OR control output.
Timer time	1 to 5000 ms: 1 to 5000 (1 to 20: 1-ms increments, 20 to 200 ms: 5-ms increments, 200 to 1000: 100-ms increments, 1000 to 5000: 1000-ms increments)	Used to change timer time. The timer can be set from 1 ms to 5 s.
External input	1-point teaching: 1Pnk, Teaching without workpiece: 2Pnk Zero-shift reset: 0r5k, Light OFF: LoFF	Used to change the functions to be remotely controlled with external input. (For the effective pulse width and other information, refer to the instructions provided with the product.)
External input memory	Write: on, Do not write: oFF	Used to set whether to write the control results to memory. (Refer to the instructions provided with the product.)
Judgment mode	C/I automatic judgment: RWto, C mode: c, I mode: i BLACK mode: blkP	Used to set the judgment mode (detection method). BLACK mode: The total light intensity for red, green, and blue is used for the judgment.

## 5 Convenient Functions

### 5-1. Zeroing the Display (Zero Reset)

The incident light level on the main display can be set to 0. This is useful when the reference display is to be reset to zero because the match display and the threshold are shifted at the same time.

\* Change the function to 0RST (zero reset) with the MODE key. The default setting is 1PNT.

→ Page 20 Refer to 4. *Setting Functions in SET Mode.*

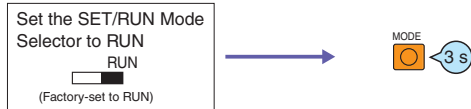

To return to original value for incident light level:

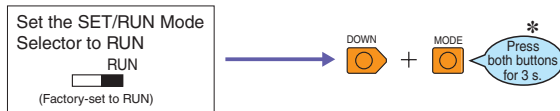

\* Press the DOWN key right after pressing the MODE key.

### 5-2. Locking the Keys (Key Lock)

All key operations can be disabled.

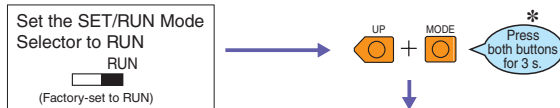

"ON" will flash twice and key operations will be disabled.

To release the lock:

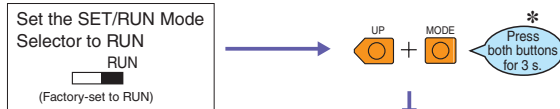

"OFF" will flash twice and key operations will be enabled.

\* If a key is pressed while key operations are locked, "LOC" will flash twice on the display to indicate that key operations have been disabled.

\* Press the UP key right after pressing the MODE key.

### 5-3. Saving a Set State (Saving User Settings)

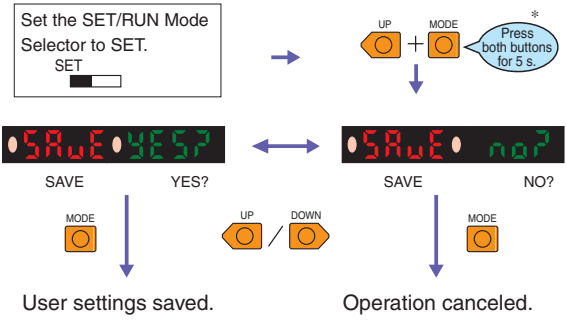

\* Be sure to register (i.e., teach) the workpiece colors if the detection functions have been changed.

### 5-4. Initializing Settings (Initialization and User Reset)

All settings will be initialized and returned to the factory settings or to a saved state.

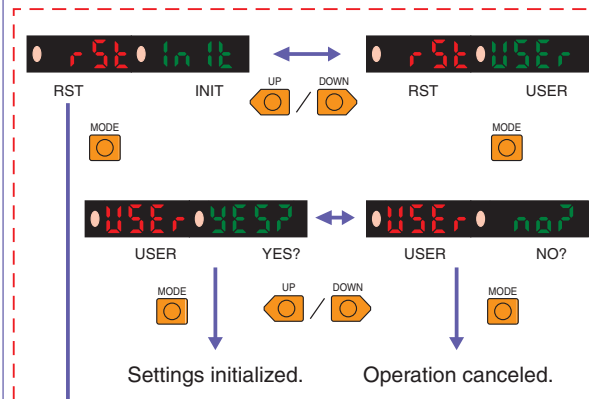

The section enclosed by dotted lines applies to user-saved settings.

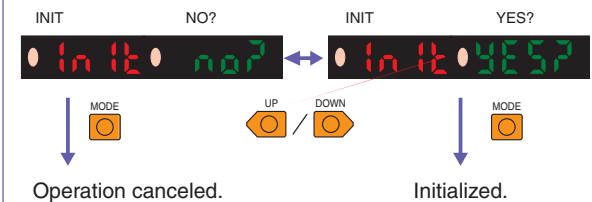



**READ AND UNDERSTAND THIS DOCUMENT**

Please read and understand this document before using the products. Please consult your OMRON representative if you have any questions or comments.

**WARRANTY**

OMRON's exclusive warranty is that the products are free from defects in materials and workmanship for a period of one year (or other period if specified) from date of sale by OMRON.

OMRON MAKES NO WARRANTY OR REPRESENTATION, EXPRESS OR IMPLIED, REGARDING NON-INFRINGEMENT, MERCHANTABILITY, OR FITNESS FOR PARTICULAR PURPOSE OF THE PRODUCTS. ANY BUYER OR USER ACKNOWLEDGES THAT THE BUYER OR USER ALONE HAS DETERMINED THAT THE PRODUCTS WILL SUITABLY MEET THE REQUIREMENTS OF THEIR INTENDED USE. OMRON DISCLAIMS ALL OTHER WARRANTIES, EXPRESS OR IMPLIED.

**LIMITATIONS OF LIABILITY**

OMRON SHALL NOT BE RESPONSIBLE FOR SPECIAL, INDIRECT, OR CONSEQUENTIAL DAMAGES, LOSS OF PROFITS OR COMMERCIAL LOSS IN ANY WAY CONNECTED WITH THE PRODUCTS, WHETHER SUCH CLAIM IS BASED ON CONTRACT, WARRANTY, NEGLIGENCE, OR STRICT LIABILITY.

In no event shall responsibility of OMRON for any act exceed the individual price of the product on which liability is asserted.

IN NO EVENT SHALL OMRON BE RESPONSIBLE FOR WARRANTY, REPAIR, OR OTHER CLAIMS REGARDING THE PRODUCTS UNLESS OMRON'S ANALYSIS CONFIRMS THAT THE PRODUCTS WERE PROPERLY HANDLED, STORED, INSTALLED, AND MAINTAINED AND NOT SUBJECT TO CONTAMINATION, ABUSE, MISUSE, OR INAPPROPRIATE MODIFICATION OR REPAIR.

**SUITABILITY FOR USE**

THE PRODUCTS CONTAINED IN THIS DOCUMENT ARE NOT SAFETY RATED. THEY ARE NOT DESIGNED OR RATED FOR ENSURING SAFETY OF PERSONS, AND SHOULD NOT BE RELIED UPON AS A SAFETY COMPONENT OR PROTECTIVE DEVICE FOR SUCH PURPOSES. Please refer to separate catalogs for OMRON's safety rated products.

OMRON shall not be responsible for conformity with any standards, codes, or regulations that apply to the combination of products in the customer's application or use of the product.

At the customer's request, OMRON will provide applicable third party certification documents identifying ratings and limitations of use that apply to the products. This information by itself is not sufficient for a complete determination of the suitability of the products in combination with the end product, machine, system, or other application or use.

The following are some examples of applications for which particular attention must be given. This is not intended to be an exhaustive list of all possible uses of the products, nor is it intended to imply that the uses listed may be suitable for the products:

- Outdoor use, uses involving potential chemical contamination or electrical interference, or conditions or uses not described in this document.
- Nuclear energy control systems, combustion systems, railroad systems, aviation systems, medical equipment, amusement machines, vehicles, safety equipment, and installations subject to separate industry or government regulations.
- Systems, machines, and equipment that could present a risk to life or property.

Please know and observe all prohibitions of use applicable to the products.

NEVER USE THE PRODUCTS FOR AN APPLICATION INVOLVING SERIOUS RISK TO LIFE OR PROPERTY WITHOUT ENSURING THAT THE SYSTEM AS A WHOLE HAS BEEN DESIGNED TO ADDRESS THE RISKS, AND THAT THE OMRON PRODUCT IS PROPERLY RATED AND INSTALLED FOR THE INTENDED USE WITHIN THE OVERALL EQUIPMENT OR SYSTEM.

**PERFORMANCE DATA**

Performance data given in this document is provided as a guide for the user in determining suitability and does not constitute a warranty. It may represent the result of OMRON's test conditions, and the users must correlate it to actual application requirements. Actual performance is subject to the OMRON Warranty and Limitations of Liability.

**CHANGE IN SPECIFICATIONS**

Product specifications and accessories may be changed at any time based on improvements and other reasons.

It is our practice to change model numbers when published ratings or features are changed, or when significant construction changes are made. However, some specifications of the product may be changed without any notice. When in doubt, special model numbers may be assigned to fix or establish key specifications for your application on your request. Please consult with your OMRON representative at any time to confirm actual specifications of purchased products.

**DIMENSIONS AND WEIGHTS**

Dimensions and weights are nominal and are not to be used for manufacturing purposes, even when tolerances are shown.

**ERRORS AND OMISSIONS**

The information in this document has been carefully checked and is believed to be accurate; however, no responsibility is assumed for clerical, typographical, or proofreading errors, or omissions.

**PROGRAMMABLE PRODUCTS**

OMRON shall not be responsible for the user's programming of a programmable product, or any consequence thereof.

**COPYRIGHT AND COPY PERMISSION**

This document shall not be copied for sales or promotions without permission.

This document is protected by copyright and is intended solely for use in conjunction with the product. Please notify us before copying or reproducing this document in any manner, for any other purpose. If copying or transmitting this document to another, please copy or transmit it in its entirety.

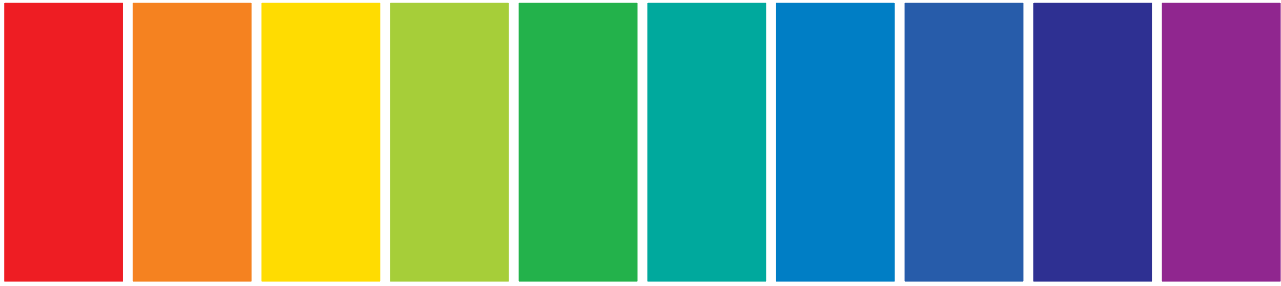

**OMRON Corporation**  
**Industrial Automation Company**  
**Sensing Devices Division H.Q.**  
**Industrial Sensors Division**

Shiokoji Horikawa, Shimogyo-ku,  
Kyoto, 600-8530 Japan  
Tel: (81)75-344-7022/Fax: (81)75-344-7107

**Regional Headquarters**

**OMRON EUROPE B.V.**

**Sensor Business Unit**

Carl-Benz-Str. 4, D-71154 Nufringen,  
Germany  
Tel: (49) 7032-811-0/Fax: (49) 7032-811-199

**OMRON ELECTRONICS LLC**

One Commerce Drive Schaumburg,  
IL 60173-5302 U.S.A.  
Tel: (1) 847-843-7900/Fax: (1) 847-843-7787

**OMRON ASIA PACIFIC PTE. LTD.**

No. 438A Alexandra Road # 05-05/08 (Lobby 2),  
Alexandra Technopark, Singapore 119967  
Tel: (65) 6835-3011/Fax: (65) 6835-2711

**OMRON (CHINA) CO., LTD.**

Room 2211, Bank of China Tower,  
200 Yin Cheng Zhong Road,  
PuDong New Area, Shanghai, 200120, China  
Tel: (86) 21-5037-2222/Fax: (86) 21-5037-2200

**Authorized Distributor:**

© OMRON Corporation 2007 All Rights Reserved.  
In the interest of product improvement,  
specifications are subject to change without notice.