

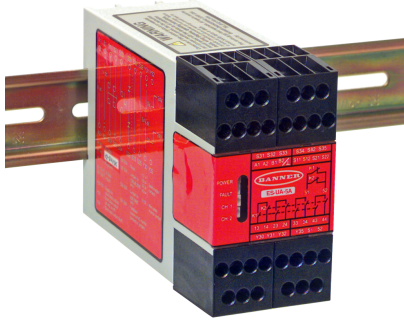

ES-UA-5A and ES-VA-5A E-Stop Safety Modules

Model ES-UA-5A for 12-24V dc/115V ac operation; **Model ES-VA-5A** for 12-24V dc/230V ac operation

Original Instructions



- Monitors emergency stop devices, such as palm buttons and rope/cable pulls, and positive-opening safety switches used for guard/gate interlocking
- **The safety inputs can monitor:**
 - Hard/relay contacts in a dual-channel hookup using terminals S11-S12 and S21-S22, or
 - A +24V dc source switched by hard/relay contacts in single-channel hookup
- Four normally open output switching channels for connection to control-reliable power interrupt circuits and three auxiliary output channels
- Automatic reset or monitored manual reset
- Design complies with standards ANSI B11.19, UL991, ISO 13850 (EN418), and ISO 13849-1 (EN954-1) (Safety Category 4)
- For use in functional stop category 0 applications per ANSI NFPA 79 and IEC/EN60204-1
- 6 amp safety output contacts; 5 amp aux. output contacts
- Plug-in terminal blocks



Model	Supply Voltage	Outputs	Output Rating
ES-UA-5A	12-24V dc or 115V ac	4 Normally open safety 1 Normally closed aux. 2 Solid-state aux.	N.O. Safety Outputs: 6 A N.C. Aux. Outputs: 5 A SS Aux. Outputs: 100 mA
ES-VA-5A	12-24V dc or 230V ac		



WARNING . . . Not a Point-of-Operation Guarding Device

This Safety Module is not a point-of-operation guarding device, as defined by OSHA regulations. It is necessary to install point-of-operation guarding devices, such as safety light curtains and/or hard guards, to protect personnel from hazardous machinery. **Failure to install point-of-operation guards on hazardous machinery can result in a dangerous condition which could lead to serious injury or death.**



Important ... read this before proceeding!

The user is responsible for satisfying all local, state, and national laws, rules, codes, and regulations relating to the use of this product and its application. Banner Engineering Corp. has made every effort to provide complete application, installation, operation, and maintenance instructions. Please direct any questions regarding the use or installation of this product to the factory applications department at the telephone numbers or address shown on back cover.

The user is responsible for making sure that all machine operators, maintenance personnel, electricians, and supervisors are thoroughly familiar with and understand all instructions regarding the installation, maintenance, and use of this product, and with the machinery it controls. The user and any personnel involved with the installation and use of this product must be thoroughly familiar with all applicable standards, some of which are listed below. Banner Engineering Corp. makes no claim regarding a specific recommendation of any organization, the accuracy or effectiveness of any information provided, or the appropriateness of the provided information for a specific application.

Applicable U.S. Standards

ANSI B11 General Safety Requirements

ANSI B11.19 Performance Criteria for Safeguarding

Contact: Safety Director, AMT – The Association for Manufacturing Technology, 7901 Westpark Drive, McLean, VA 22102, Tel.: 703-893-2900

ANSI NFPA79, Electrical Standard for Industrial Machinery

Contact: National Fire Protection Association, 1 Batterymarch Park, P.O. Box 9101, Quincy, MA 02269-9101, Tel.: 800-344-3555

ANSI/RIA R15.06, Safety Requirements for Industrial Robots and Robot Systems

Contact: Robotic Industries Association, 900 Victors Way, P.O. Box 3724, Ann Arbor, MI 48106, Tel.: 734-994-6088

Applicable International Standards

ISO 12100-1 (EN292-1), Safety of Machinery – Basic Concepts, General Principles for Design, Part 1: Basic Terminology, Methodology

ISO 12100-2 (EN292-2), Safety of Machinery – Basic Concepts, General Principles for Design, Part 2: Technical Principles and Specifications

IEC 60204-1, Electrical Equipment of Machines: General Requirements

IEC 61508, Functional Safety of Electrical/Electronic/Programmable Electronic Safety-Related Systems

IEC 62061, Safety of Machinery – Functional Safety of Safety-Related Electrical, Electronic and Programmable Electronic Control Systems

ISO 13849-1 (EN954-1), Safety of Machinery – Related Parts of Control Systems: Part 1 General Principles for Design

ISO 13850 (EN418), Emergency Stop Devices

Contact: Global Engineering Documents, 15 Inverness Way East, Englewood, CO 80112-5704, Tel.: 800-854-7179

Overview

An Emergency Stop Safety Module is used to increase the control reliability of an emergency stop circuit. As shown in the hookup drawings, the models **ES-UA-5A** and **ES-VA-5A** E-Stop Safety Modules (the Safety Modules) are designed to monitor a 1-channel or 2-channel E-stop switch. A 2-channel E-stop switch has two electrically isolated contacts.

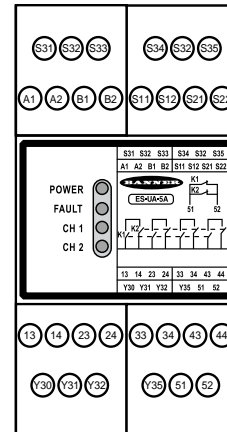

Figure 1: Features and terminals

Safety Circuit Integrity and ISO 13849-1 Safety Circuit Principles

Safety circuits involve the safety-related functions of a machine that minimize the level of risk of harm. These safety-related functions can prevent initiation, or they can stop or remove a hazard. The failure of a safety-related function or its associated safety circuit usually results in an increased risk of harm.

The integrity of a safety circuit depends on several factors, including fault tolerance, risk reduction, reliable and well-tried components, well-tried safety principles, and other design considerations.

Depending on the level of risk associated with the machine or its operation, an appropriate level of safety circuit performance (i.e., integrity) must be incorporated into its design. Standards that detail safety performance levels include ANSI/RIA R15.06, ANSI B11 and B11.19, OSHA 29CFR1910.217, and ISO 13849-1 (EN954-1).

Safety Circuit Integrity Levels

Safety circuits in international and European standards are segmented into categories, depending on their ability to maintain their integrity in the event of a failure. The most recognized of these standards is ISO 13849-1 (EN954-1), which establishes five levels: Categories B, 1, 2, 3, and the most stringent, Category 4.

In the United States, the typical level of safety circuit integrity has been called "control reliability." Control reliability typically incorporates redundant control and self-checking circuitry and has been loosely equated to ISO 13849-1 Categories 3 and 4 (see CSA Z432 and ANSI B11.TR4).

If the requirements described by ISO 13849-1 are to be implemented, a risk assessment must first be performed to determine the appropriate category, in order to ensure that the expected risk reduction is achieved. This risk assessment must also take into account national regulations, such as U.S. control reliability or European "C" level standards, to ensure that the minimum mandated level of performance is complied with.

⚠ WARNING . . . Safety Categories

The level of safety circuit integrity can be greatly impacted by the design and installation of the safety devices and the means of interfacing of those devices. **A risk assessment must be performed to determine the appropriate safety circuit integrity level or safety category as described by ISO 13849-1 (EN 954-1) to ensure that the expected risk reduction is achieved and that all relevant regulations and standards are complied with.**

Fault Exclusion

An important concept within the category requirements of ISO 13849-1 is the "probability of the occurrence of the failure," which can be decreased using a technique termed "fault exclusion." The rationale assumes that the possibility of certain well-defined failure(s) can be reduced to a point where the resulting fault(s) can be, for the most part, disregarded – that is, "excluded."

Fault exclusion is a tool a designer can use during the development of the safety-related part of the control system and the risk assessment process. Fault exclusion allows the designer to design out the possibility of various failures and justify it, through the risk assessment process, to meet the intent requirements of Category 2, 3 or 4. See ISO 13849-1/-2 for further information.

Monitoring of Safety Devices

Requirements vary widely for the level of control reliability or safety category per ISO 13849-1 (EN954-1) in safety applications. While Banner Engineering always recommends the highest level of safety in any application, it is the responsibility of the user to safely install, operate and maintain each safety system and comply with all relevant laws and regulations.

While only two applications are listed below, the Module can monitor a variety of devices as long as the input requirements are complied with (see Electrical Installation and Specifications). **The Safety Module does not have 500 ms simultaneity between inputs and thus can not be used for monitoring a two-hand control.** In all cases, the safety performance (integrity) must reduce the risk from identified hazards as determined by the machine's risk assessment.



WARNING . . . Emergency Stop Functions

Do not mute or bypass any emergency stop device. ANSI NFPA79 and IEC/EN 60204-1 require that the emergency stop function remain active at all times. **Muting or bypassing the Safety Outputs will render the emergency stop function ineffective.**

Emergency-Stop Push Buttons and Rope/Cable Pull Switches:

The safety inputs can be interfaced with positive-opening switches to monitor an emergency-stop (E-stop) push button or rope/cable pull. The switch must provide one or two contacts for safety which are closed when the switch is armed. Once activated, the E-stop switch must open all its safety-rated contacts, and must require a deliberate action (such as twisting, pulling, or unlocking) to return to the closed-contact, armed position. The switch must be a "positive-opening" (or direct-opening) type, as described by IEC 60947-5-1.

Standards ANSI NFPA 79, IEC/EN 60204-1, and ISO 13850 specify additional emergency stop switch device requirements, including the following:

- Emergency-stop push buttons shall be located at each operator control station and at other operating stations where emergency shutdown is required.
- Stop and emergency-stop push buttons shall be continuously operable and readily accessible from all control and operating stations where located. **Do not mute or bypass E-stop buttons or rope/cable pulls.**
- Actuators of emergency-stop devices shall be colored red. The background immediately around the device actuator shall be colored yellow (where possible). The actuator of a push-button-operated device shall be of the palm or mushroom-head type.
- The emergency-stop actuator shall be a self-latching type.

For Rope/Cable Pull installations only:

- The wire rope should be easily accessible and visible along its entire length. Markers or flags may be fixed on the rope to increase its visibility.
- Mounting points, including support points, must be rigid.
- The rope should be free of friction at all supports. Pulleys are recommended.

Some applications may have additional requirements; **comply with all relevant regulations**. See the device manufacturer installation instructions for complete information (such as **SSA-EB.-..** p/n 111880, or **RP-RM83F..** p/n 141245 installation data sheets).

Interlocked Guards (Gates)

The safety inputs can be interfaced with positive-opening safety switches to monitor the position of an interlock guard or gate. Each switch must provide electrically isolated contacts: at minimum, one normally closed (N.C.) contact from each individually mounted switch. The contacts must be of "positive-opening" (direct-opening) design, as described by IEC 60947- 5-1, with one or more normally closed contacts rated for safety. In addition, the switches must be mounted in a "positive mode," to move/disengage the actuator from its home position and open the normally closed contact when the guard opens.

In higher levels of safety performance, the design of a dual-channel coded magnetic switch typically uses complementary switching, in which one channel is open and one channel is closed at all times. **The inputs of the Safety Module do not support complementary switching, and thus should not be used with coded magnetic safety switches.**

The design and installation of the interlocked guard and the safety switches should comply with ANSI B11.19, ISO14119, and other applicable standards. See the device manufacturer installation instructions for complete information (such as **SI-LS83/-LS100** p/n 59622, or **SI-HG63** p/n 129465 installation data sheets).

Mechanical Installation

The Safety Module must be installed inside an enclosure. It is not designed for exposed wiring. **It is the user's responsibility to house the Safety Module in an enclosure with NEMA 3 (IEC IP54) rating, or better.**

The Safety Module mounts directly to standard 35 mm DIN rail; see Dimensions.

Heat Dissipation Considerations

For reliable operation, ensure that the operating specifications are not exceeded. The enclosure must provide adequate heat dissipation, so that the air closely surrounding the Module does not exceed the maximum operating temperature stated in the Specifications. Methods to reduce heat build-up include venting, forced airflow (e.g., exhaust fans), adequate enclosure exterior surface area, and spacing between modules and other sources of heat.

Electrical Installation

WARNING . . . Shock Hazard

Always disconnect power from the Safety Module and all power from the machine being controlled before making any connections or replacing any component. Electrical installation and wiring must be made by qualified personnel and must comply with the NEC (National Electrical Code), ANSI NFPA79 or IEC 60204-1, and all applicable local standards and codes.

It is not possible to give exact wiring instructions for a Safety Module which interfaces to a multitude of machine control configurations. The following guidelines are general in nature.

The Safety Module has no delay function. Its output relay contacts open within 25 milliseconds after a safety input opens. This classifies the Safety Module as a functional stop "Category 0" E-stop control, as defined by ANSI NFPA 79 and IEC/EN 60204-1.

The Safety Module is powered by either a 12-24V dc supply at 4W or an ac supply (115V ac, model **ES-UA-5A**, or 230V ac, model **ES-VA-5A**) at 7VA. The safety inputs can be connected to:

- A +24V dc source that is switched by a hard/relay contact in single-channel hookup configuration, or
- Hard/relay contacts in a dual-channel hookup configuration using terminals S11-S12 and S21-S22.

Safety Input Device Hookup Options

The operation of all dual-channel hookup options is concurrent, meaning that input channel 1 and input channel 2 must be in the same state in both the STOP and RUN condition, but with no simultaneity (i.e. timing) requirement between the channels.

The **dual-channel hookup configuration** is able to detect certain failures and faults, such as short circuits, that could result in a loss of the safety function. Once such a failure or fault is detected, the Safety Module will turn OFF (open) its safety outputs until the problem is fixed. This circuit can meet ISO 13849-1 Category 2, 3, or 4 requirements, depending on the safety rating and the installation of the safety input device. This circuit can detect a short circuit between channels or to another source of power, at a minimum, when the device is actuated.

A single device with redundant outputs that can fail in such a manner to lose the safety function, such as a single safety interlocking switch, can typically meet only Category 2. See below for means to eliminate or minimize the possibility of failures and faults that could result in the loss of the safety function(s).

The **single-channel hookup configuration** can not detect short circuits to secondary sources of +24V dc or detect the loss of the switching function of the safety input device (i.e., it is not redundant) and thus this circuit typically can meet only ISO 13849-1 Category 2.

It is recommended that in all circumstances the installation of the Safety Module and its associated safety input devices are installed to eliminate or minimize the possibility of failures and faults that could result in the loss of the safety function(s).

Methods to eliminate or minimize the possibility of these failures include, but are not limited to:

- Physically separating interconnecting control wires from each other and from secondary sources of power.
- Routing interconnecting control wires in separate conduit, runs, or channels.
- Locating all elements (modules, switches, and devices under control) within one control panel, adjacent to each other, and directly connected with short wires.
- Properly installing multi-conductor cabling and multiple wires through strain-relief fittings. (Over-tightening of a strain-relief can cause short circuits at that point.)
- Using positive-opening components as described by IEC 60947-5-1, installed and mounted in a positive mode.
- Periodically checking the functional integrity / safety function and training operators, maintenance personnel, and others associated with the operation of the machine to recognize and immediately correct such failures.

If you have any questions about your intended use, please contact a Banner applications engineer at the numbers listed on the last page.

Connection of Multiple Switches

Connect the poles of multiple switches, such as E-Stop switches, as shown in the following hookup figures. The switches are shown in the "armed" position with both contacts closed. Multiple switches connected to one Safety Module must be series connected (see figure at right and the warning, Multiple Switching Devices).

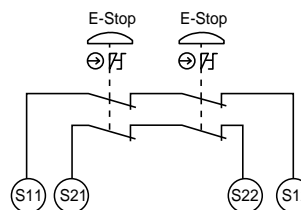

Figure 2: Series connection of multiple E-stop switches

⚠ WARNING . . . Multiple Safety Devices

When two or more safety devices are used, each device must be individually actuated, causing a STOP or open-contact condition, then reset/rearmed and the Safety Module reset (if using manual reset mode). This allows the monitoring circuits to check each device and its wiring to detect faults. Failure to test each device individually in this manner could result in undetected faults and create an unsafe condition which could result in serious injury or death.

NOTE: The minimum amount of time for the Module to detect a STOP condition is 15 ms. This "recovery time" (OFF-state) is required for the internal integrity tests to complete, allowing a reliable reset to occur. A lockout may occur if the Module is cycled too quickly. To clear the lockout, the inputs must be re-cycled, meeting the minimum recovery time requirements.

Connection of Safety Switches

The Safety Module may be used to monitor safety interlocking switches that determine the position of a guard or gate. To achieve Category 4 operation per ISO 13849-1 (EN 954-1), two positive-opening safety switches must operate concurrently when the guard or gate is opened (see figure at right).

The Safety Module verifies concurrent opening of two contacts – one from each safety switch. Reset of the Safety Module is not possible if one switch fails to open, or if a short circuit between the safety interlocking switches occurs.

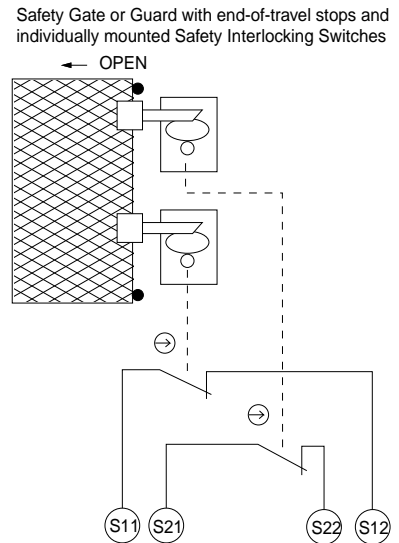

Figure 3: Hookup using contacts from two safety switches

Connection of Reset Switch

The reset circuit switch can be any mechanical switch, such as a normally open momentary switch, or a two-position key switch. The reset switch must be capable of reliably switching 12 to 30V dc at 20 to 50 milliamps. As shown in the hookup drawings, the reset switch connects between Safety Module terminals S33 and S34.

The reset switch must be located outside of – and not be accessible from – the area of dangerous motion, and must be positioned so that any area of dangerous motion may be observed by the switch operator during the reset procedure. See warning below.

⚠ WARNING . . . Reset Switch Location

The reset switch must be accessible only from outside, and in full view of, the hazardous area. Reset switches must also be out of reach from within the safeguarded space, and must be protected against unauthorized or inadvertent operation (e.g., through the use of rings or guards). If any areas are not visible from the reset switch(es), additional means of safeguarding must be provided. Failure to do so could result in serious bodily injury or death.

 **WARNING . . . Reset Routine Required**

U.S. and international standards require that a reset routine be performed after clearing the cause of a stop condition (e.g., arming an E-stop button, closing an interlocked guard, etc.). **Allowing the machine to restart without actuating the normal start command/device can create an unsafe condition which could result in serious injury or death.**

Automatic Reset Mode

The Safety Module may be configured (via hookup) for automatic reset. If no MSC contacts are monitored, install a jumper between terminals S32 and S35 (see hookups). The Safety Module will reset (and its outputs energize) as soon as the switch returns to its armed (closed-contact) position.

Automatic reset is useful for some automated processes. **However, if automatic reset is used, it is necessary to provide a means of preventing resumption of hazardous machine motion, until an alternate reset procedure is performed.** The alternate procedure must include a reset/restart switch, located outside the area of dangerous motion, which is positioned so that any area of dangerous motion may be observed by the switch operator during the reset procedure. See Warning.

Connection to the Machine to be Controlled

The machine hookup diagrams show a generic connection of the Safety Module's redundant output circuits to the master stop control elements (MSCs). An MSC is defined as an electrically powered device, external to the Safety Module, which stops the machinery being controlled by immediately removing electrical power to the machine and (when necessary) by applying braking to dangerous motion. This stopping action is accomplished by removing power to the actuator of either MSC.

External Device Monitoring

To satisfy the requirements of Control Reliability (OSHA and ANSI), Category 3 and 4 of ISO 13849-1 (EN 954-1), the Machine Primary Control Elements (MPCEs) must each offer a normally closed, forced-guided (mechanically linked) monitor contact. Connect one normally closed monitor contact from each Machine Primary Control Element as shown in the appropriate hookup drawing.

In operation, if one of the switching contacts of either MPCE fails in the energized condition, the associated monitor contact will remain open. Therefore, it will not be possible to reset the Primary Safety Device. If no MPCE-monitor contacts are monitored, **it is the user's responsibility to ensure that any single failure will not result in a hazardous condition and will prevent a successive machine cycle.**

Hookup Drawings

Auto Reset

AC Power shown

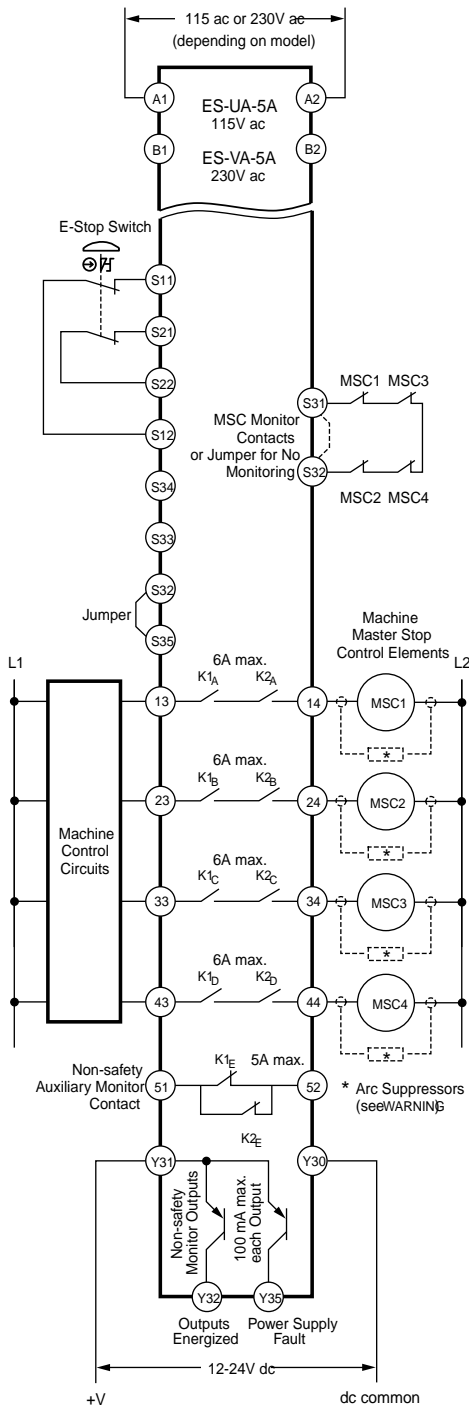

Manual Reset

DC Power shown

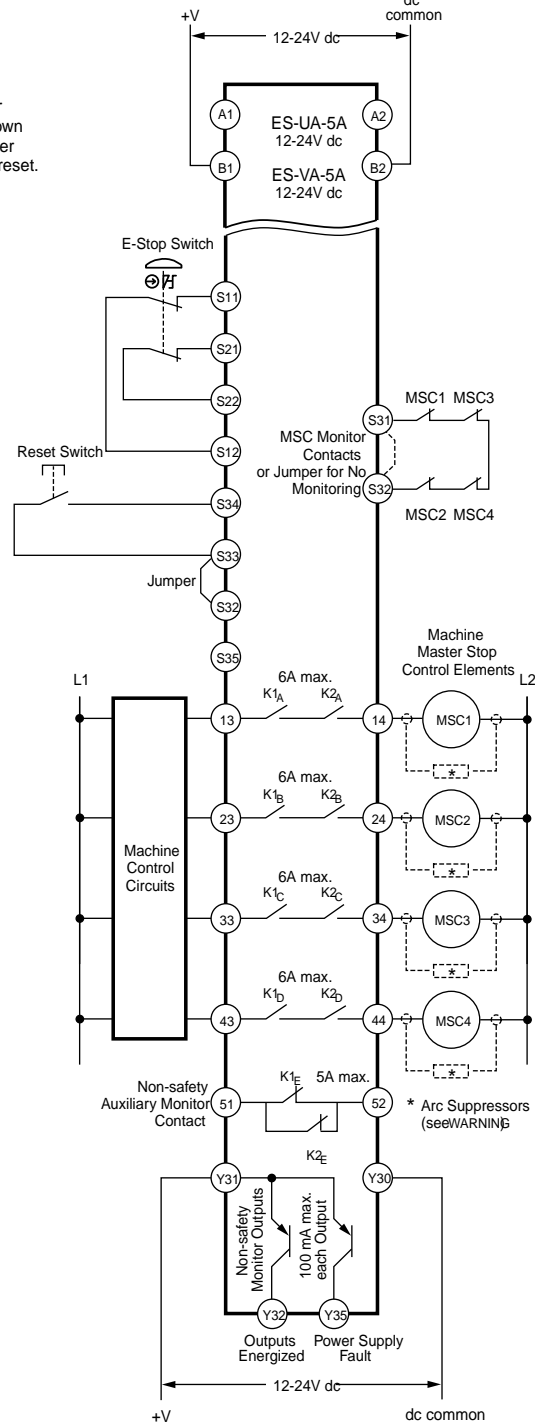

AC or DC power connections shown are valid for either auto or manual reset.

Figure 4: Hookup: 2-Channel E-stop applications

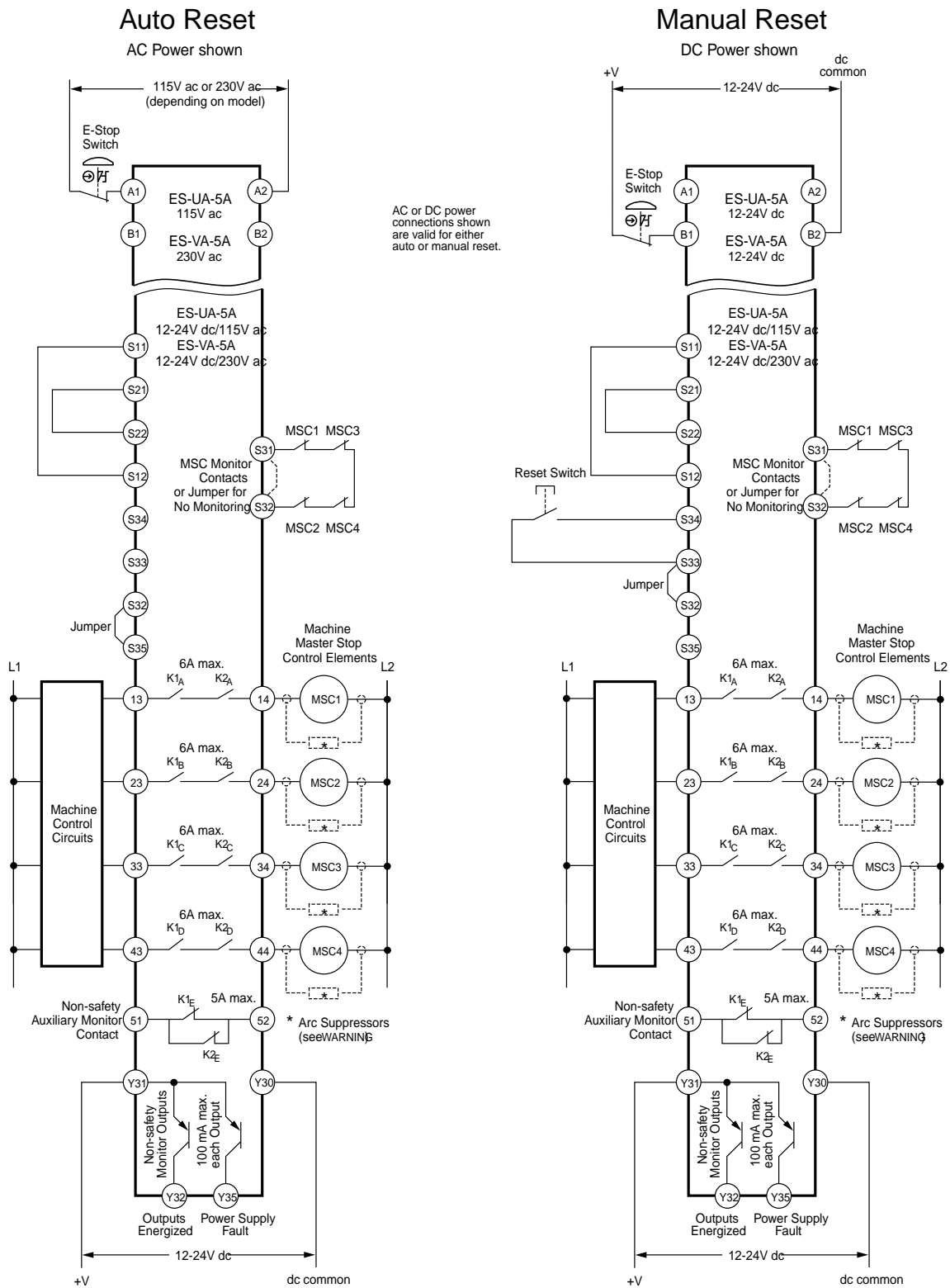

Figure 5: Hookup: 1-Channel E-stop applications

Overvoltage Category II and III Installations (EN 50178 and IEC 60664-1)

The Safety Module is rated for Overvoltage Category III when voltages of 1V to 150V ac/dc are applied to the output relay contacts. It is rated for Overvoltage Category II when voltages of 151V to 250V ac/dc are applied to the output relay contacts and no additional precautions are taken to attenuate possible overvoltage situations in the supply voltage. The Module can be used in an Overvoltage Category III environment (with voltages of 151V to 250V ac/dc) if care is taken either to reduce the level of electrical disturbances seen by the Module to Overvoltage Category II levels by installing surge suppressor devices (e.g., arc suppressors), or to install extra external insulation in order to isolate both the Safety Module and the user from the higher voltage levels of a Category III environment.

Overvoltage Category III Installations

When output contact voltage 151V to 250V ac/dc is applied to the output contact(s): the Safety Module may be used under the conditions of a higher overvoltage category where appropriate overvoltage reduction is provided. Appropriate methods include:

- An overvoltage protective device
- A transformer with isolated windings
- A distribution system with a multiplicity of branch circuits (capable of diverting energy of surges)
- A capacitance capable of absorbing energy of surges
- A resistance or similar damping device capable of dissipating the energy of surges

When switching inductive ac loads, it is good practice to install appropriately-sized arc suppressors to protect the Safety Module outputs. However, if arc suppressors are used, they must be installed across the load being switched (e. g., across the coils of external safety relays), and never across the Safety Module's output contacts (see WARNING, "Wiring of Arc Suppressors").

Auxiliary Monitor Contact/Solid-State Monitor Outputs Connection

The action of the auxiliary monitor contact (terminals 51-52) inversely "follows" the action of the safety outputs. There are also two solid-state monitor outputs, each capable of switching up to 100 mA at 12-24V dc. One output at terminal Y32 follows the action of the output circuits (K1 and K2); the other output at terminal Y35 opens (low signal) when there is a loss of power or a fault is detected. A typical use for these outputs is to communicate the status of the Safety Module to a programmable logic controller (PLC). See hookups for more information. **These outputs are to be used only for control functions that are NOT safety-related.**

WARNING . . . Wiring of Arc Suppressors

If arc suppressors are used, they MUST be installed as shown across the actuator coil of the Master Stop Control Elements (MSC1 to MSC4). **NEVER install suppressors directly across the output contacts of the Safety Module.** It is possible for suppressors to fail as a short circuit. If installed directly across the output contacts of the Safety Module, **a short-circuited suppressor will create an unsafe condition which could result in serious injury or death.**

WARNING . . . Interfacing MSCs

NEVER wire an intermediate device(s) (e.g., PLC, PES, PC) between the Safety Module outputs and the Master Stop Control Element it switches in such a manner that in the event of a failure there is a loss of the safety stop command, OR in such a manner that the safety function can be suspended, overridden, or defeated, unless accomplished with the same or greater degree of safety.

Whenever forced-guided, mechanically linked relays are added as intermediate switching devices, a normally closed forced-guided monitor contact from each relay must be added to the series feedback loop between Safety Module terminals S31 and S32.

Initial Checkout Procedure



CAUTION . . . Disconnect Power Prior to Checkout

Before performing the initial checkout procedure, make certain all power is disconnected from the machine to be controlled.

Dangerous voltages may be present along the Safety Module wiring barriers whenever power to the machine control elements is ON. **Exercise extreme caution whenever machine control power is or may be present. Always disconnect power to the machine control elements before opening the enclosure that houses the Safety Module.**

1. Remove power from the machine primary control elements.
2. Ensure the safety device is in a STOP or "open-contact" state (e.g., actuate the E-stop switch to open its contacts).
3. Apply power to the Safety Module at terminals A1 and A2 or B1 and B2. Verify that only the Input Power indicator is ON. If either input channel 1 or input channel 2 indicators are ON at this point, disconnect the input power and check all wiring. Return to step 2 after the cause of the problem has been corrected.
4. Reset or otherwise cause the safety device to reach an ON or "closed-contact" state (e.g., arm the E-stop switch to close its contacts).
5. **Manual Reset mode:** Ch1 and Ch2 indicators should be flashing. Close and reopen the Reset switch.
6. Verify that the Ch1 and Ch2 indicators both come ON. If only one indicator comes ON or if any indicator is flashing, refer to the Troubleshooting section for more information. Return to step 2 after correcting the problem.
7. Cause the safety device to generate a STOP or "open-contact" state (e.g., actuate the E-stop switch to open its contacts). The Ch1 and Ch2 indicators should turn OFF simultaneously. If either indicator remains ON, disconnect the input power and check all wiring. Return to step 2 after the cause of the problem has been corrected. Refer to the Troubleshooting section for more information.
8. **If more than one safety device is series-connected to the Safety Module, run the above checkout procedure individually for EACH device.**
9. Close and secure the enclosure in which the Safety Module is mounted. Apply power to the machine control elements and perform the Periodic Checkout Procedure.



WARNING . . . Multiple Safety Devices

When two or more safety devices are used, each device must be individually actuated, causing a STOP or open-contact condition, then reset/rearmed and the Safety Module reset (if using manual reset mode). This allows the monitoring circuits to check each device and its wiring to detect faults. Failure to test each device individually in this manner could result in undetected faults and create an unsafe condition which could result in serious injury or death.

Periodic Checkout Procedure

The functioning of the Safety Module and the device(s) connected to it must be verified on a regular periodic basis to ensure proper operation (see also the machine manufacturer's recommendations).

1. With the machine running, cause the safety device to generate a STOP or "open-contact" state (e.g., actuate the E-stop switch to open its contacts). Verify that the machine stops.
2. Reset or otherwise cause the safety device to reach an ON or "closed-contact" state. Verify that the machine does not restart.
3. **If using manual reset mode,** close and then open the reset switch within 2 seconds. Verify that the machine can be restarted by normal initiation.

4. If more than one safety device is series-connected to the Safety Module, run the above checkout procedure individually for EACH device.

Repairs

⚠ CAUTION . . . Abuse of Module After Failure

If an internal fault has occurred and the Module will not reset, **do not tap, strike, or otherwise attempt to correct the fault by a physical impact to the housing.** An internal relay may have failed in such a manner that its replacement is required.







If the Module is not immediately replaced or repaired, multiple simultaneous failures may accumulate such that the safety function can not be guaranteed.



Do not attempt any repairs to the Module. It contains no field-replaceable components. Return it to the factory for warranty repair or replacement: Contact Banner Factory Application Engineering at the address or the numbers listed on the back page. They will attempt to troubleshoot the system from your description of the problem. If they conclude that a component is defective, they will issue a return merchandise authorization (RMA) number for your paperwork, and give you the proper shipping address.

Pack the Module carefully. Damage which occurs in return shipping is not covered by warranty.

Specifications

Category	Specification
Supply Voltage and Current	<p>AI-A2: 115V ac (model ES-UA-5A) or 230V ac (model ES-VA-5A) ±15% , 50/60Hz</p> <p>BI-B2: 11V dc – 27.6V dc</p> <p>Power consumption: approx. 4W/7VA</p> <p>The Safety Module should be connected only to a SELV (safety extra-low voltage, for circuits without earth ground) or a PELV (protected extra-low voltage, for circuits with earth ground) power supply.</p>
Supply Protection Circuitry	Protected against transient voltages and reverse polarity
Overvoltage Category	<p>Output relay contact voltage of 1V to 150V ac/dc: category III</p> <p>Output relay contact voltage of 151V to 250V ac/dc: category III, if appropriate overvoltage reduction is provided (see Overvoltage Category III Installations on page 11).</p>
Pollution Degree	2
Relay Outputs	<p>4 normally open (N.O.) output channels and 1 normally closed (N.C.) auxiliary output</p> <p>Each normally open output channel is a series connection of contacts from two forced-guided (mechanically linked) relays, K1-K2. The normally closed Aux. output channel is a parallel connection of contacts from two forced-guided relays, K1-K2.</p> <p>Contacts: AgNi, 5 µm gold-plated</p> <p>Low Current Rating: The 5 µm gold-plated contacts allow the switching of low current/low voltage. In these low-power applications, multiple contacts can also be</p>

Category	Specification																		
	<p>switched in series (e.g., “dry switching”). To preserve the gold plating on the contacts, do not exceed the following max. values at any time:</p> <p>Min. voltage: 1V ac/dc Max. voltage: 60V Min. current: 5 mA ac/dc Max. current: 300 mA Min. power: 5 mW (5 mVA) Max. power: 7 W (7 VA)</p> <p>High Current Rating: If higher loads must be switched through one or more of the contacts, the minimum and maximum values of the contact(s) changes to:</p> <table border="1" style="width: 100%; border-collapse: collapse;"> <thead> <tr> <th style="width: 10%;"></th> <th style="width: 45%;">Minimum:</th> <th style="width: 45%;">Maximum</th> </tr> </thead> <tbody> <tr> <td rowspan="3" style="text-align: center; vertical-align: middle;">  </td> <td>Voltage: 15V ac/dc</td> <td rowspan="2">N.O. Safety Contacts (13-14, 23-24, 33-34, 43-44): 250V ac / 24V dc, 6A resistive B300, Q300 (UL508)</td> </tr> <tr> <td>Current: 250 mA ac/dc</td> </tr> <tr> <td>Power: 5 W (5 VA)</td> <td>N.C. Auxiliary Contact (51-52): 250V ac / 24V dc, 5A resistive B300, Q300 (UL508)</td> </tr> </tbody> </table> <table border="1" style="width: 100%; border-collapse: collapse; margin-top: 10px;"> <thead> <tr> <th style="width: 10%;"></th> <th style="width: 45%;">Minimum:</th> <th style="width: 45%;">Maximum — IEC60947-5-1</th> </tr> </thead> <tbody> <tr> <td rowspan="3" style="text-align: center; vertical-align: middle;">  </td> <td>Voltage: 15V ac/dc</td> <td rowspan="2">N.O. Safety Contacts: AC-1: 250V ac, 6A; DC-1: 24V dc, 6A AC-15: 230V ac, 3A; DC-13: 24V dc, 4A</td> </tr> <tr> <td>Current: 250 mA ac/dc</td> </tr> <tr> <td>Power: 5 W (5 VA)</td> <td>N.C. Auxiliary Contact: AC-1: 250V ac, 5A; DC-1: 24V dc, 5A AC-15: 230V ac, 2A; DC-13: 24V dc, 4A</td> </tr> </tbody> </table> <p>Mechanical life: > 50,000,000 operations Electrical life: 150,000 cycles @ 1500 VA; 1,000,000 cycles @ 450 VA; 2,000,000 cycles @ 250 VA; 5,000,000 cycles @ 125 VA NOTE: Transient suppression is recommended when switching inductive loads. Install suppressors across load. Never install suppressors across output contacts (see Warning, Wiring of Arc Suppressors).</p>		Minimum:	Maximum		Voltage: 15V ac/dc	N.O. Safety Contacts (13-14, 23-24, 33-34, 43-44): 250V ac / 24V dc, 6A resistive B300, Q300 (UL508)	Current: 250 mA ac/dc	Power: 5 W (5 VA)	N.C. Auxiliary Contact (51-52): 250V ac / 24V dc, 5A resistive B300, Q300 (UL508)		Minimum:	Maximum — IEC60947-5-1		Voltage: 15V ac/dc	N.O. Safety Contacts: AC-1: 250V ac, 6A; DC-1: 24V dc, 6A AC-15: 230V ac, 3A; DC-13: 24V dc, 4A	Current: 250 mA ac/dc	Power: 5 W (5 VA)	N.C. Auxiliary Contact: AC-1: 250V ac, 5A; DC-1: 24V dc, 5A AC-15: 230V ac, 2A; DC-13: 24V dc, 4A
	Minimum:	Maximum																	
	Voltage: 15V ac/dc	N.O. Safety Contacts (13-14, 23-24, 33-34, 43-44): 250V ac / 24V dc, 6A resistive B300, Q300 (UL508)																	
	Current: 250 mA ac/dc																		
	Power: 5 W (5 VA)	N.C. Auxiliary Contact (51-52): 250V ac / 24V dc, 5A resistive B300, Q300 (UL508)																	
	Minimum:	Maximum — IEC60947-5-1																	
	Voltage: 15V ac/dc	N.O. Safety Contacts: AC-1: 250V ac, 6A; DC-1: 24V dc, 6A AC-15: 230V ac, 3A; DC-13: 24V dc, 4A																	
	Current: 250 mA ac/dc																		
	Power: 5 W (5 VA)	N.C. Auxiliary Contact: AC-1: 250V ac, 5A; DC-1: 24V dc, 5A AC-15: 230V ac, 2A; DC-13: 24V dc, 4A																	
Solid-State Outputs	<p>Two non-safety solid-state dc outputs</p> <p>Output circuits require application of +12-24V dc ± 15% at terminal Y31; dc common at Y30.</p> <p>Max. switching current: 100 mA at 12-24V dc</p> <p>Both outputs are protected against short circuits.</p> <p>Output at Y32 monitors state of outputs – conducts (output high) when both K1 and K2 are energized.</p> <p>Output at Y35 conducts (output high) when in normal operation (no lockout).</p>																		
Output Response Time	35 ms max. (25 ms typical)																		

Category	Specification
Input Requirements	<p>E-stop switch: must have normally closed contacts each capable of switching 20 to 50 mA @ 12 to 30V dc; and must be open \geq 15 ms for a valid stop command.</p> <p>Maximum input resistance 250 ohms per channel @ 24V dc supply voltage.</p> <p>Maximum input resistance 25 ohms per channel @ 12V dc supply voltage.</p> <p>Reset switch: must have one normally open contact capable of switching 20 to 50 mA @ 12 to 30V dc.</p>
OFF-State Recovery Time	350 ms max.
Indicators	<p>3 green LED indicators: Power ON , Channel 1, Channel 2</p> <p>1 red LED indicator: indicates a fault condition (see Troubleshooting)</p>
Construction	Polycarbonate housing. Rated NEMA 1, IEC IP20
Mounting	Mounts to standard 35 mm DIN rail track. Safety Module must be installed inside an enclosure rated NEMA 3 (IEC IP54), or better.
Vibration Resistance	<p>10 to 60 Hz @ 0.35 mm peak displacement per UL 991</p> <p>60 to 150 Hz @ 5 g max.</p>
Operating Conditions	<p>Temperature: 0° to +50°C (+32° to 122°F), (surrounding air)</p> <p>Max. Relative Humidity: 90% @ +50°C (non-condensing)</p>
Design Standards	Cat. 4 PL e per EN ISO 13849-1; SIL 3 per IEC 61508 and IEC 62061
Certifications	  

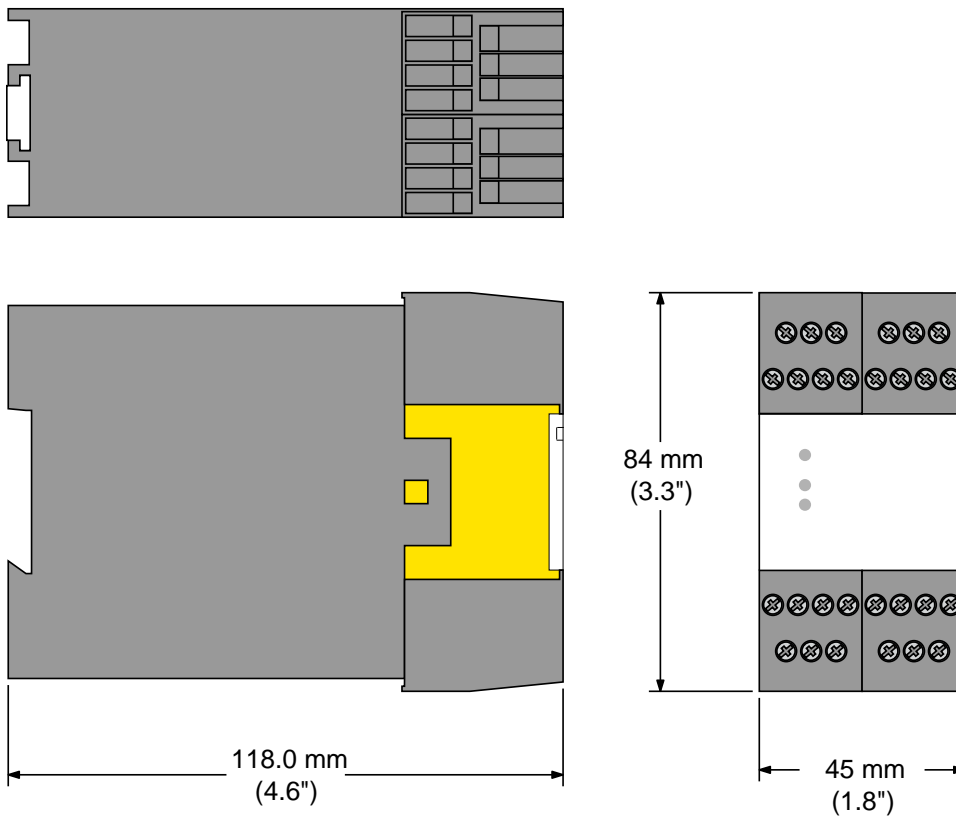

Figure 6: Dimensions — in mm (inches)

Troubleshooting

Condition	Indicator Status	Possible Causes / Solutions
Module will not reset	Power LED ON Fault LED OFF Ch1 LED Flashing Ch2 LED Flashing	Waiting for manual reset: <ul style="list-style-type: none"> • EDM monitoring contacts are not closed. Check MSCs. • Check jumper at S32-S35 (auto reset) or S32-S33 (manual reset). • Check reset button connection.
No fault indicated	Power LED ON Fault LED OFF Ch1 LED OFF Ch2 LED OFF	E-stop button open: <ul style="list-style-type: none"> • Connector loose. • Re-arm E-stop button.
No fault indicated	Power LED ON Fault LED OFF Ch1 LED OFF Ch2 LED ON	Ch.1 open; Ch. 2 closed: <ul style="list-style-type: none"> • Check wiring to S11-S12. • Check switch. • Check connectors are properly seated.
No fault indicated	Power LED ON Fault LED OFF	Ch.1 closed; Ch. 2 open: <ul style="list-style-type: none"> • Check wiring to S21-S22.

Condition	Indicator Status	Possible Causes / Solutions
	Ch1 LED ON Ch2 LED OFF	<ul style="list-style-type: none"> • Check switch. • Check connectors are properly seated.
Fault	Power LED ON Fault LED ON* Ch1 and Ch2 LED flashing alternately	<p>Input concurrency fault: Both inputs did not open concurrently. Both inputs are now closed.</p> <ul style="list-style-type: none"> • Check switches/wiring at both inputs. • Open both inputs to clear the fault.
Fault	Power LED ON Fault LED ON* Ch1 LED OFF Ch2 LED Flashing	<p>Input concurrency fault: Ch1 opened and closed and is now open while Ch2 remained closed.</p> <ul style="list-style-type: none"> • Check switches/wiring at both inputs. • Open both inputs to clear the fault.
Fault	Power LED ON Fault LED ON* Ch1 LED Flashing Ch2 LED OFF	<p>Input concurrency fault: Ch1 remained closed while Ch2 opened and closed and is now open.</p> <ul style="list-style-type: none"> • Check switches/wiring at both inputs. • Open both inputs to clear the fault .
Fault	Power LED ON Fault LED ON* Ch2 LED ON Ch1 LED ON	<p>Possible input fault: Ch1 and Ch 2 are closed and are (or were) shorted together.</p> <ul style="list-style-type: none"> • Check wiring at both inputs. • Open both inputs to clear the fault. <p>Possible internal fault:</p> <ul style="list-style-type: none"> • Return to factory for repair or replacement
	All LEDs OFF	<p>Possible fault in machine control or wiring to module:</p> <ul style="list-style-type: none"> • Check input power connections or external fuses. • Check connectors are properly seated.
	Dim LEDs	<p>Dim Power LED:</p> <ul style="list-style-type: none"> • Check power supply capacity and load. <p>Other LEDs dim:</p> <ul style="list-style-type: none"> • May glow during power-up (normal). • Check power supply load and capacity.
	*Fault LED Flickers	This is normal while the Fault LED is ON.
MSCs do not energize	Power LED ON Fault LED OFF Ch1 LED ON Ch2 LED ON	<p>Possible fault in machine control or an open circuit between machine control and MSCs:</p> <ul style="list-style-type: none"> • Check continuity of safety outputs (e.g. between terminals 13 and 14). • Check control wires and connectors. • Check MSCs.

EC Declaration of Conformity

Banner Engineering Corp. herewith declares that **ES-UA-5A** and **ES-VA-5A** Emergency Stop Modules for industrial control are in conformity with the provisions of the Machinery Directive (Directive 2006/42/EC), and all essential Health and Safety Requirements have been met. Download the complete EC Declaration of Conformity as a PDF file at <http://www.bannerengineering.com/ESmodule>

Contact Us

**For more information:
Contact your local Banner
representative or Banner
Corporate Offices around
the world.**

Corporate Headquarters

Banner Engineering Corp. 9714 Tenth Ave. North Mpls., MN 55441 Tel: 763-544-3164 www.bannerengineering.com sensors@bannerengineering.com

Europe

Banner Engineering Europe Park Lane Culliganlaan 2F Diegem B-1831 BELGIUM Tel: 32-2 456 07 80 Fax: 32-2 456 07 89 www.bannereurope.com mail@bannereurope.com

Latin America

Contact Banner Engineering Corp. (US) or e-mail **Mexico:** mexico@bannerengineering.com **Brazil:** brasil@bannerengineering.com

Asia China

Banner Engineering China Shanghai Rep Office Rm. G/H/I, 28th Flr. Cross Region Plaza No. 899, Lingling Road Shanghai 200030 CHINA Tel: 86-21-54894500 Fax: 86-21-54894511 www.bannerengineering.com.cn sensors@bannerengineering.com.cn

Asia Japan

Banner Engineering Japan Cent-Urban Building 305 3-23-15 Nishi-Nakajima Yodogawa-Ku, Osaka 532-0011 JAPAN Tel: 81-6-6309-0411 Fax: 81-6-6309-0416 www.bannerengineering.co.jp mail@bannerengineering.co.jp

Asia

Banner Engineering Asia Taiwan Neihu Technology Park 5F-1, No. 51, Lane 35, Jihu Rd. Taipei 114 TAIWAN Tel: 886-2-8751-9966 Fax: 886-2-8751-2966 www.bannerengineering.com.tw info@bannerengineering.com.tw

India

Banner Engineering India Pune Head Quarters Office No. 1001 Sai Capital, Opp. ICC Senapati Bapat Road Pune 411016 INDIA Tel: 91-20-66405624 Fax: 91-20-66405623 www.bannerengineering.co.in india@bannerengineering.com



Warranty: Banner Engineering Corp. will repair or replace, free of charge, any product of its manufacture found to be defective at the time it is returned to the factory during the warranty period. This warranty does not cover damage or liability for the improper application of Banner products. This warranty is in lieu of any other warranty either expressed or implied.