



Contactor, 15kW/400V, DC-operated

Part no. DILM32-10(RDC24)

Article no. 277274

Program

Product range			Contactors
Application			Contactors for Motors
Subrange			Contactors up to 170 A, 3 pole
Connection technique			Screw terminals
Pole			3 pole
Rated operational current			
AC-3			
380 V 400 V	I_e	A	32
AC-1			
Conventional free air thermal current, 3 pole, 50 - 60 Hz			
Open			
at 40 °C	$I_{th}=I_e$	A	45
Max. rating for three-phase motors, 50 - 60 Hz			
AC-3			
220 V 230 V	P	kW	10
380 V 400 V	P	kW	15
660 V 690 V	P	kW	17
AC-4			
220 V 230 V	P	kW	4
380 V 400 V	P	kW	7
660 V 690 V	P	kW	10
Contacts			
N/O = Normally open			1 N/O
Contact sequence			
Instructions			Contacts to EN 50012. integrated suppressor circuit in actuating electronics with mirror contact.
Can be combined with auxiliary contact			DILM32-XHI.. DILA-XHI(V).. DILM32-XHI11-S
Voltage AC/DC			DC operation

Approbationen

Product Standards
UL File No.
UL CCN
CSA File No.
CSA Class No.
NA Certification
Specially designed for NA

IEC/EN 60947-4-1; UL 508; CSA-C22.2 No. 14-05; CE marking
E29096
NLDX
012528
2411-03, 3211-04
UL listed, CSA certified
No

General

Standards			IEC/EN 60947, VDE 0660, UL, CSA
Lifespan, mechanical			
AC operated	Operations	x 10^6	10
DC operated	Operations	x 10^6	10
Operating frequency, mechanical			

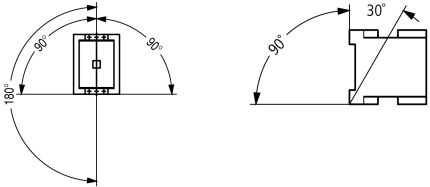
AC operated	Operations/h		5000
DC operated	Operations/h		5000
Climatic proofing			Damp heat, constant to IEC 60068-2-78 Damp heat, cyclic to IEC 60068-2-30
Ambient temperature	°C		
Open	°C		- 25 - 60
Enclosed	°C		- 25 - 40
Storage	°C		- 40 - 80
Mounting position, AC- and DC operated			
Mechanical shock resistance (IEC/EN 60068-2-27)			
Half-sinusoidal shock, 10 ms			
Main contacts			
N/O contact	g		10
Auxiliary contacts			
N/O contact	g		7
N/C contact	g		5
Mechanical shock resistance (IEC/EN 60068-2-27) when tabletop-mounted			
Half-sinusoidal shock, 10 ms			
Main contacts			
N/O contact	g		6.9
Auxiliary contacts			
N/O contact	g		5.3
N/C contact	g		3.5
Protection type			IP00
Protection against direct contact when actuated from front (EN 90274)			Finger- and back-of-hand proof
Weight			
AC operated	kg		0.42
DC operated	kg		0.48
Terminal capacity main cable			
Solid	mm ²		1 x (0.75 - 16) 2 x (0.75 - 10)
Flexible with ferrule	mm ²		1 x (0.75 - 16) 2 x (0.75 - 10)
Stranded	mm ²		1 x 16
Solid or stranded	AWG		18 - 6
Main cable connection screw/bolt			M5
Tightening torque	Nm		3.2
Terminal capacity control circuit cables			
Solid	mm ²		1 x (0.75 - 4) 2 x (0.75 - 4)
Flexible with ferrule	mm ²		1 x (0.75 - 1.5) 2 x (0.75 - 1.5)
Solid or stranded	AWG		18 - 14
Control circuit cable connection screw/bolt			M3.5
Tightening torque	Nm		1.2
Tool			
Main cable			
Pozidriv screwdriver	Size		2
Standard screwdriver	mm		0.8 x 5.5 1 x 6
Control circuit cables			

Pozidriv screwdriver		Size	2
Standard screwdriver		mm	0.8 x 5.5 1 x 6
Terminal capacity control circuit cables			
Solid		mm ²	1 x (0.75 - 2.5) 2 x (0.75 - 2.5)
Flexible		mm ²	1 x (0.75 - 2.5) 2 x (0.75 - 2.5)
Flexible with ferrule		mm ²	1 x (0.75 - 1.5) 2 x (0.75 - 1.5)
Solid or stranded		AWG	18 - 14
Tool			
Stripping length		mm	10
Screwdriver blade width		mm	3.5

Main conducting paths

Rated impulse withstand voltage	U _{imp}	V AC	8000
Overvoltage category/pollution degree			III/3
Rated insulation voltage	U _i	V AC	690
Rated operational voltage	U _e	V AC	690
Safe isolation to VDE 0106 Part 101 and Part 101/A1			
between coil and contacts		V AC	440
between the contacts		V AC	440
Making capacity (p.f. to IEC/EN 60947)			
	Up to 690 V	A	384
Breaking capacity			
220/230 V		A	320
380/400 V		A	320
500 V		A	320
660/690 V		A	180
Short-circuit rating			
Short-circuit protection maximum fuse			
Type "2" coordination			
400 V	gG/gL 500 V	A	63
690 V	gG/gL 690 V	A	35
Type "1" coordination			
400 V	gG/gL 500 V	A	125
690 V	gG/gL 690 V	A	63

AC

AC-1 duty			
Conventional free air thermal current, 3 pole, 50 - 60 Hz			
Open			
at 40 °C	I _{th} =I _e	A	45
at 50 °C	I _{th} =I _e	A	43
at 55 °C	I _{th} =I _e	A	42
at 60 °C	I _{th} =I _e	A	40
enclosed	I _{th}	A	36
Conventional free air thermal current, 1 pole			
open	I _{th}	A	100
enclosed	I _{th}	A	90
AC-3 duty			
Rated operational current AC-3 open, 50 - 60 Hz, 3 pole	I _e		

220/230 V	I_e	A	32
240 V	I_e	A	32
380/400 V	I_e	A	32
415 V	I_e	A	32
440V	I_e	A	32
500 V	I_e	A	32
660/690 V	I_e	A	18
Motor rating	P	kWh	
220/230 V	P	kW	10
240V	P	kW	11
380/400 V	P	kW	15
415 V	P	kW	19
440 V	P	kW	20
500 V	P	kW	23
660/690 V	P	kW	17
AC-4 duty			
Rated operational current AC-4 open, 50 - 60 Hz, 3 pole	I_e		
220/230 V	I_e	A	15
240 V	I_e	A	15
380/400 V	I_e	A	15
415 V	I_e	A	15
440 V	I_e	A	15
500 V	I_e	A	15
660/690 V	I_e	A	12
Motor rating	P	kWh	
220/230 V	P	kW	4
240 V	P	kW	4.5
380/400 V	P	kW	7
415 V	P	kW	7.5
440 V	P	kW	8
500 V	P	kW	9
660/690 V	P	kW	10

DC

Rated operational current, open			
DC-1 operation			
60 V	I_e	A	40
110 V	I_e	A	40
220 V	I_e	A	40
440 V	I_e	A	2.9
DC-3 operation			
60 V	I_e	A	40
110 V	I_e	A	40
220 V	I_e	A	25
440 V	I_e	A	0.6
DC-5 operation			
60 V	I_e	A	40
110 V	I_e	A	40
220 V	I_e	A	10
440 V	I_e	A	0.6
Current heat loss (3 pole)			
Current heat loss at I_{th}		W	12.1
Current heat loss at I_e to AC-3/400 V		W	6.1
Impedance per pole		mΩ	2

Magnet systems

Voltage tolerance		x U _c	
AC operated	Pick-up	x U _c	0.8 - 1.1
Drop-out voltage AC operated	Drop-out	x U _c	0.3 - 0.6
Notes			RDC 24 (U _{min} 24 V DC/U _{max} 27 V DC) Example: U _c = 0.7 x U _{min} - 1.2 x U _{max} / U _c = 0.7 x 24 V - 1.2 x 27 V DC
DC operated	Pick-up	x U _c	0.7 - 1.2
Notes			at least smoothed two-phase bridge rectifier or three-phase rectifier
DC operated	Drop-out	x U _c	0.15 - 0.6
Power consumption of the coil in a cold state and 1.0 x U _c			
50 Hz	Pick-up	VA	52
50 Hz	Sealing	VA	7.1
50 Hz	Sealing	W	2.1
60 Hz	Pick-up	VA	67
60 Hz	Sealing	VA	8.7
60 Hz	Sealing	W	2.6
50/60 Hz	Pick-up	VA	62 58
50/60 Hz	Sealing	VA	9.1 6.5
50/60 Hz	Sealing	W	2.5 2
DC operated	Pick-up	W	12
DC operated	Sealing	W	0.5
Duty factor		% DF	100
Switching times at 100 % U _c (approximate values)			
Main contacts			
AC operated			
Closing delay		ms	16 - 22
Opening delay		ms	8 - 14
DC operated		ms	
Closing delay		ms	47
Opening delay		ms	30
Arcing time		ms	10
Lifespan, mechanical; Coil 50/60 Hz	at 50 Hz		Mechanical lifespan at 50 Hz approx. 30% lower than under "Technical data, general"

Electromagnetic compatibility (EMC)

Emitted interference			to EN 60947-1
Interference immunity			to EN 60947-1

Technical data according to ETIM 4.0

Number of main contacts as N/Os			3
Rated operation current I _e at AC-1, 400 V			45
Connection type main circuit			Screw connection
Rated control voltage U _s at AC 60HZ		V	0
Number of auxiliary contacts as N/Os			1
Rated control voltage U _s at AC 50HZ		V	0
Number of auxiliary contacts as N/Cs			0
Suitable for rail-mounting			No
Rated control voltage U _s at DC		V	27
Voltage type for actuation			DC
Rated operation current I _e at AC-3, 400 V		A	32
Number of N/Cs as main contact			0
Motor rating at AC-3, 400 V		kWh	15

Characteristics

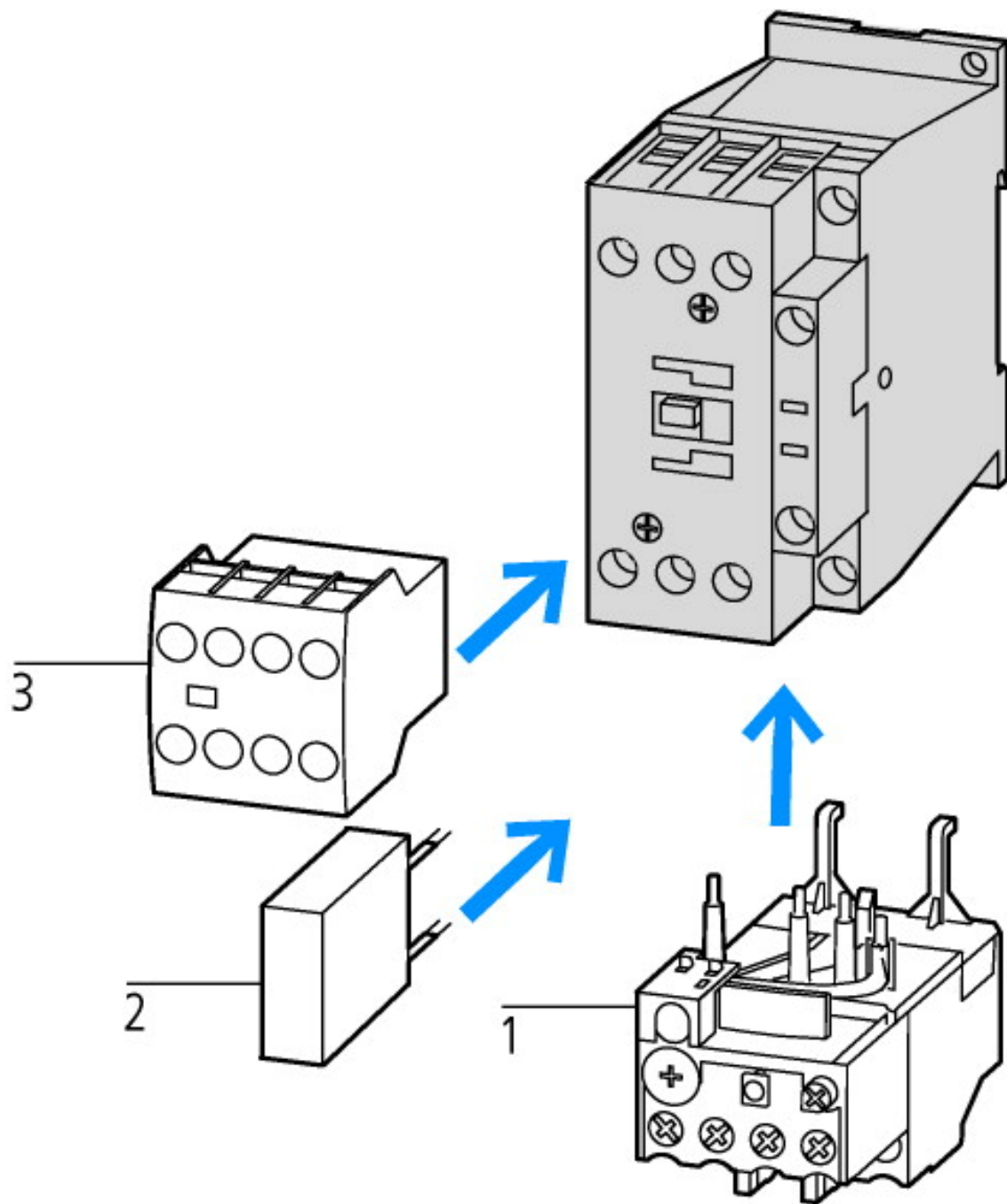

- 1: Overload relay
- 2: Suppressor
- 3: Auxiliary contact modules

Projektieren

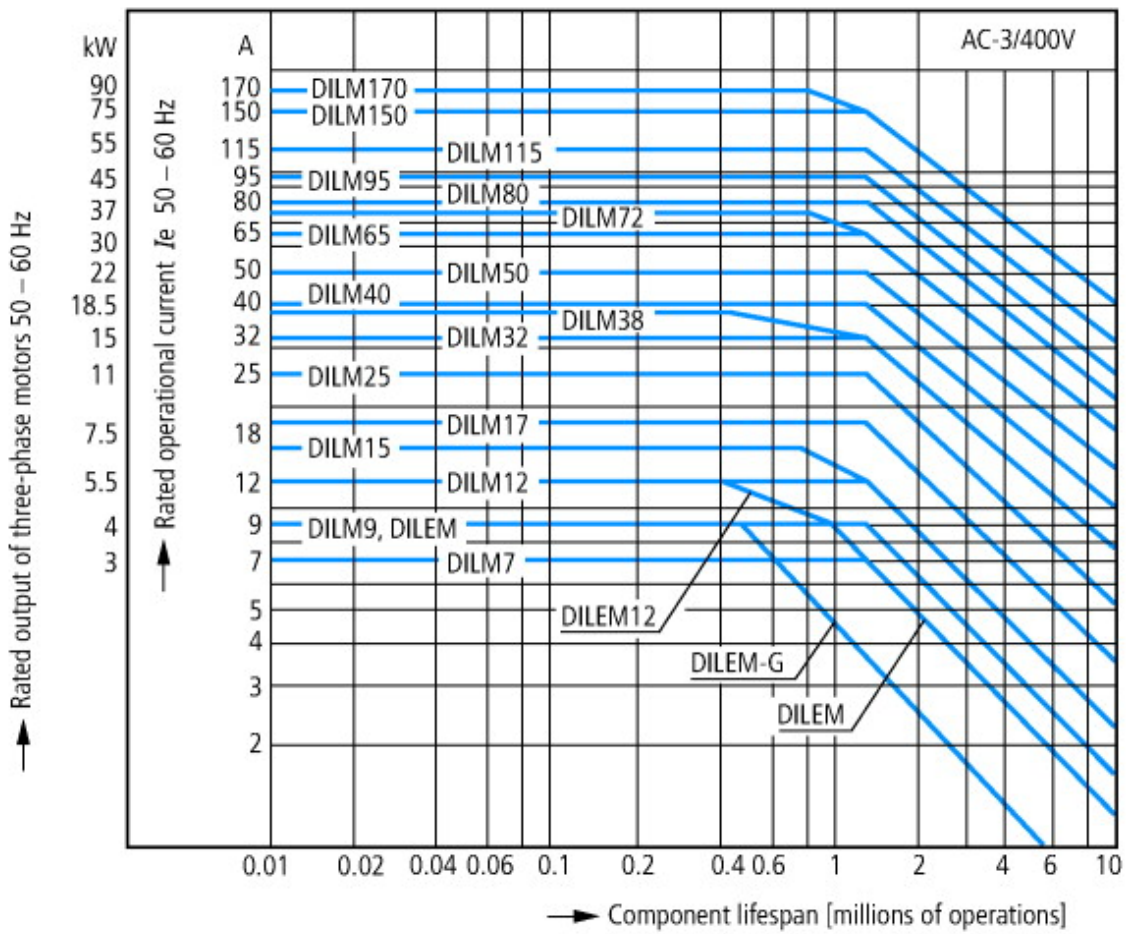

- Squirrel-cage motor
- Operating characteristics
- Starting: from rest
- Stopping: after attaining full running speed
- Electrical characteristics
- Make: up to 6 x rated motor current
- Break: up to 1 x rated motor current
- Utilization category
- 100 % AC-3
- Typical applications
- Compressors
- Lifts
- Mixers
- Pumps
- Escalators
- Agitators
- Fans
- Conveyor belts
- Centrifuges
- Hinged flaps
- Bucket-elevators
- Air conditioning system
- General drives in manufacturing and processing machines

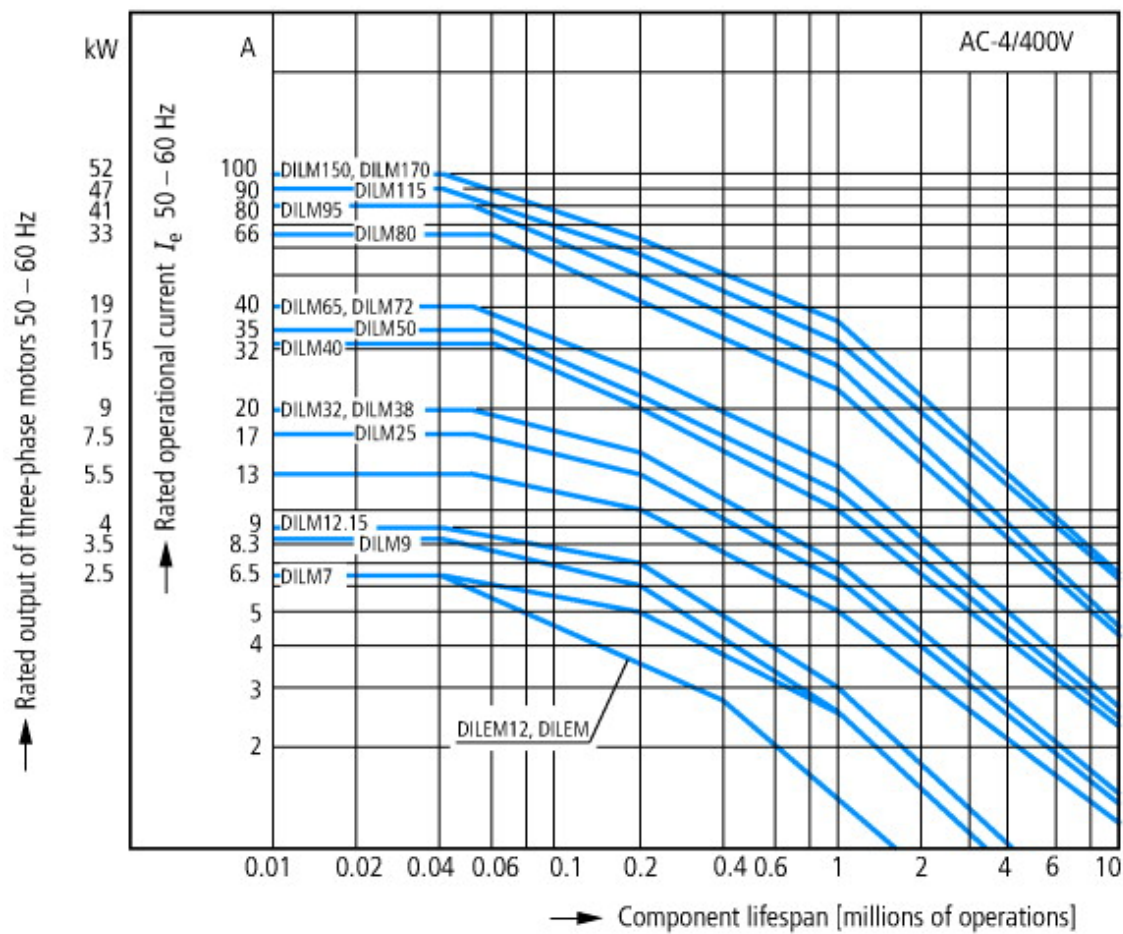

- Extreme switching duty
- Squirrel-cage motor
- Operating characteristics
- Inching, plugging, reversing
- Electrical characteristics
- Make: up to 6 x rated motor current
- Break: up to 6 x rated motor current
- Utilization category
- 100 % AC-4
- Typical applications
- Printing presses
- Wire-drawing machines
- Centrifuges
- Special drives for manufacturing and processing machines

CAD-Data

Product standards CAD data:

<http://eaton-moeller.partcommunity.com/PARTcommunity/Portal/eaton-moeller>

Dimensions

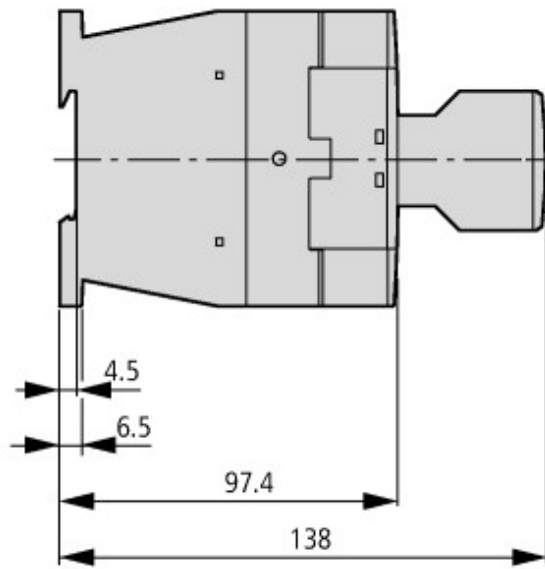
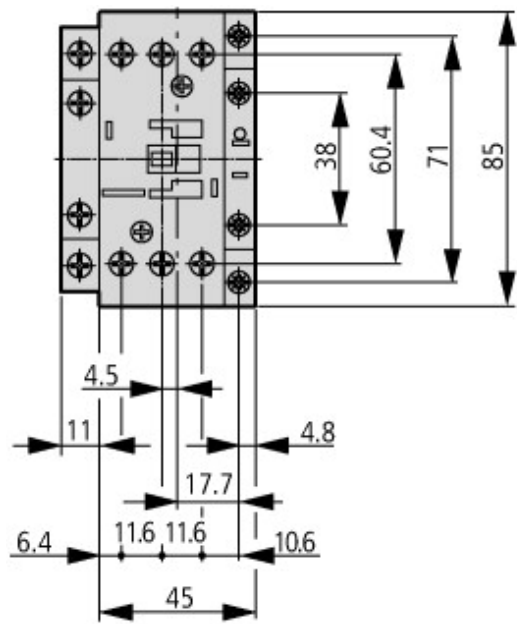

Contactor with auxiliary contact module

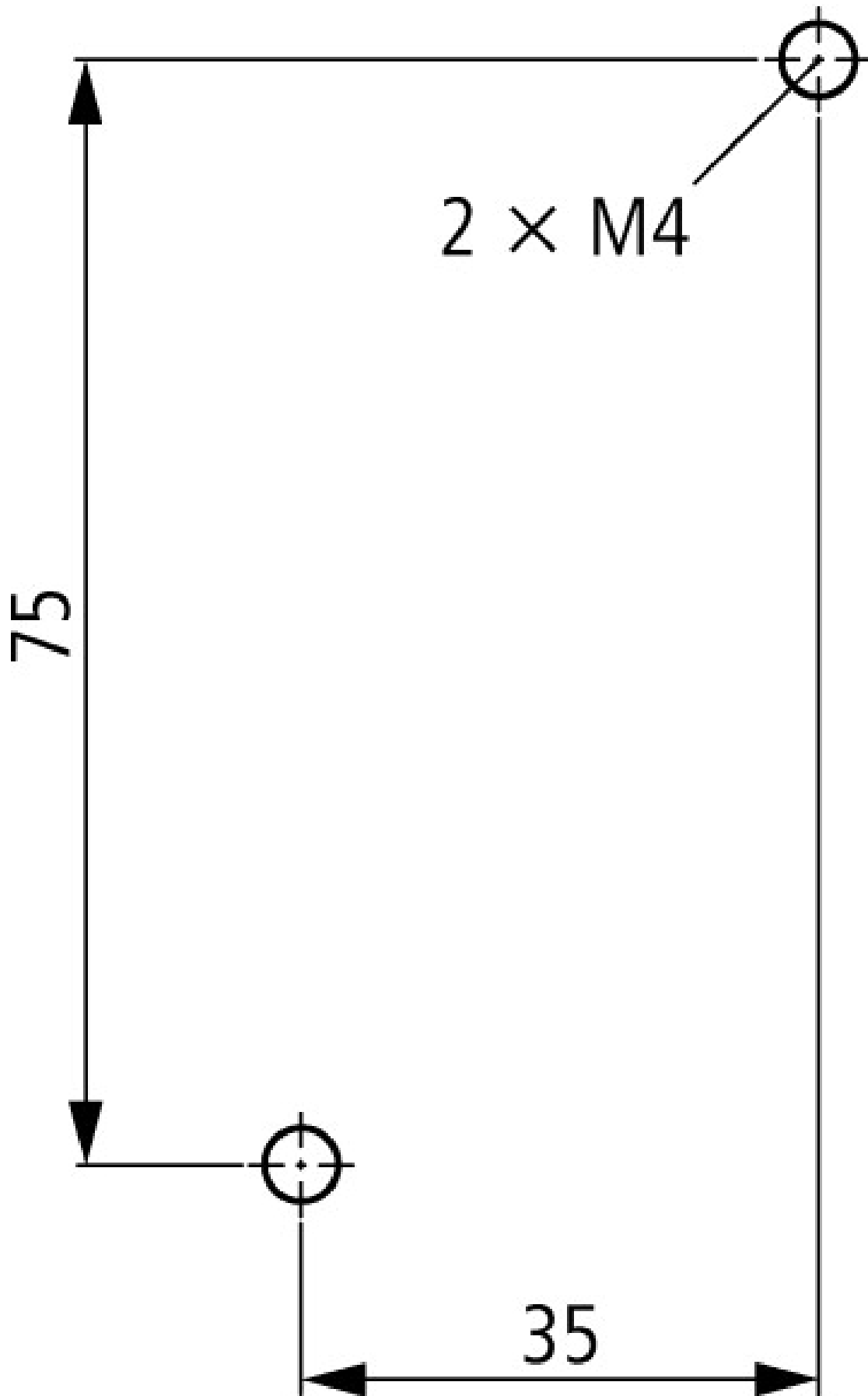

Lateral clearance to earthed parts: 6 mm

Additional product information (links)

IL03407014Z (IL03407014Z) Contactor

ftp://ftp.moeller.net/DOCUMENTATION/AWA_INSTRUCTIONS/IL03407014Z2010_10.pdf

Installation Instructions

http://www.moeller.net/en/support/instructions_awa.jsp

Documentation	http://www.moeller.net/en/support/index.jsp
Engineering	
Projektieren	Projektieren
Motor starters and "Special Purpose Ratings" for the North American market	http://www.moeller.net/binary/ver_techpapers/ver953en.pdf
Busbar Component Adapters for modern Industrial control panels	http://www.moeller.net/binary/ver_techpapers/ver960en.pdf
The Interaction of Contactors with PLCs	http://www.moeller.net/binary/ver_techpapers/ver957en.pdf
Standard Compliant and Functionally Safe Engineering Design with Mechanical Auxiliary Contacts	http://www.moeller.net/binary/ver_techpapers/ver956en.pdf
Switchgear for Luminaires	http://www.moeller.net/binary/ver_techpapers/ver955en.pdf
Effect of the Cabel Capacitance of Long Control Cables on the Actuation of Contactors	http://www.moeller.net/binary/ver_techpapers/ver949en.pdf
X-Start - Modern Switching Installations Efficiently Fitted and Wired Securely	http://www.moeller.net/binary/ver_techpapers/ver938en.pdf
Mirror Contacts for Highly-Reliable Information Relating to Safety-Related Control Functions	http://www.moeller.net/binary/ver_techpapers/ver944en.pdf
X-Start - New Generation:100 years of Moeler contactors - Continuous Progress-	http://www.moeller.net/binary/ver_techpapers/ver937en.pdf
Switchgear of Power Factor Correction Systems	http://www.moeller.net/binary/ver_techpapers/ver934en.pdf