

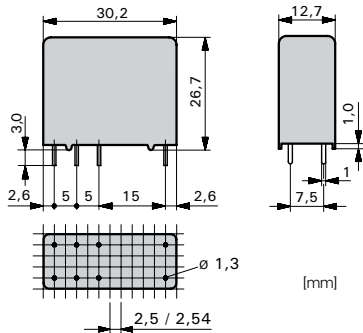

Relay data

- PCB relay with forcibly guided contacts
- Protective separation between coil and contacts (leakage and creeping distances > 14mm); protective separation diagonally between left and right contact side (leakage and creeping distances > 5,5mm)
- EN 50205, type B
- 2 CO contacts
- Mean coil power 1W



Contact material	AgSnO ₂ +0,2μm Au
Type of contact	Single contact
Rated switching capacity	250VAC 8A AC1 2'000VA
Electr. life AC1 (360 cycles/h)	approx. 100'000
Inrush current max.	15A for 20ms
Switching current range*	10mA to 8A
Switching capacity range*	0,12VA(W) to 2'000VA
Contact resistance (as delivered)	≤ 100mΩ

* Guide values

Standard coils for direct current
(other voltages on request)

Nominal voltage VDC	Min. pick-up voltage at 20°C	Drop-out voltage at 20 °C	Nominal current in mA	Resistance in Ohm at 20 °C	Tolerance in %
5	3,75	≥ 0,5	181,0	27,5	± 10
6	4,5	≥ 0,6	166,0	36	± 10
12	9,0	≥ 1,2	85,7	140	± 10
24	18,0	≥ 2,4	33,3	720	± 10
48	36,0	≥ 4,8	20,8	2'300	± 10
60	45,0	≥ 6,0	13,6	4'400	± 13
110	82,5	≥ 11,0	11,0	10'000	± 15

Ordering example

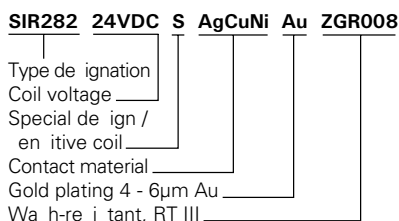

General data

Circuit diagram (view on relay upper side)

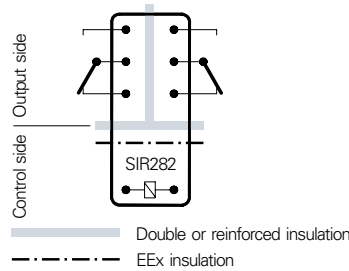

Mechanical life	> 50 x 10 ⁶ operations
Switching frequency, mechanical	20Hz
Response time	typically 12ms
Drop-out time**	typically 5ms
Bounce time of NO contact	typically 4ms
Bounce time of NC contact	typically 8ms
Vibration resistance	10-55Hz, AK 10g, RK 1,5g
Test voltage coil/contacts	5'000Veff 1min
Test voltage contact set/contact set	4'000Veff 1min
Test voltage contact open	1'500Veff 1min
Insulation resistance	10 ¹¹ Ω
Creeping resistance	CTI 550
Weight	approx. 20g
Mounting position	any
Ambient temperature	-40°C to +70°C
Type of protection	RT II / RT III optionally
Solder bath temperature	270°C/5s
Thermal resistance	50K/W
Temperature limit for coil	120°C

** without spark suppression

Insulation terms

Coil/contacts: Double or reinforced insulation
EEx insulation > 14mm
Left to right contact side:
Double or reinforced insulation > 5,5mm

Tests, regulations

Approvals	SEV, UL, cUL, TÜV
Insulation class	VDE 0110 / group C 250VAC
Protection class II	VDE 0106
Fire protection requirements	UL 94 / V1

Options, accessories

Wash-resistant RT III SIR282..VDC ZGR008
PCB socket, DIN rail socket see page 23

Diagrammes

Contact lifetime for NO contact

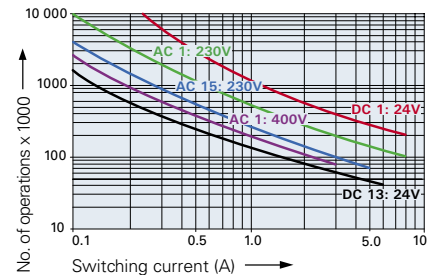

Max. switching characteristics (acc. to DIN EN 60947-5-1 table C2):
AC 15: 230V/5A, DC13: 24V/6A
Maximal contact load at AC 1 with 230V:
2 contacts each with 8A

Contact lifetime for NC contact

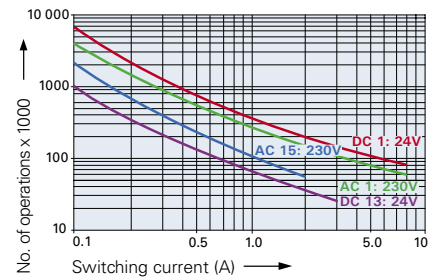

Max. switching characteristics (acc. to DIN EN 60947-5-1 table C2):
AC 15: 230V/2A, DC13: 24V/3A

Load limit curve with direct current

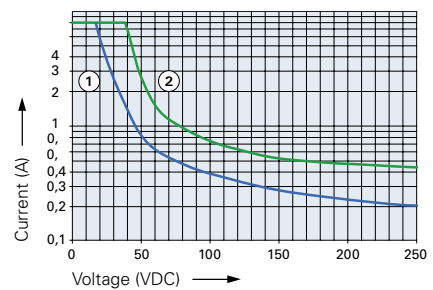

- 1) Inductive load, L/R 40 ms
- 2) Resistive load

Excitation voltage range

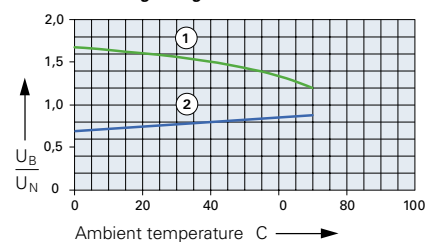

- 1) Max. excitation voltage with contact load ≤ 2A
- 2) Min. excitation voltage (guaranteed values) without previous operation

No heat accumulation due to intrinsic heating of other components. Continuous duty 100%.

