

1-Axis Magnetic Sensor HMC1041Z

The Honeywell HMC1041Z is a z-axis surface mount option designed for low field magnetic sensing. By adding the HMC1041Z to other 2-axis magneto-resistive sensors, a cost effective and space-efficient 3-axis magnetometer or compassing solution is enabled. This compact, low cost solution is easy to assemble for high volume, cost effective OEM designs. Applications for the HMC1041Z include Compassing, Navigation Systems, Magnetometry, and Current Sensing.

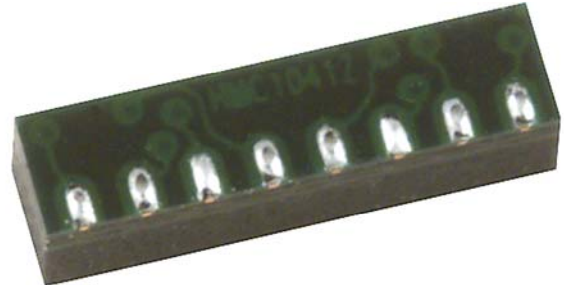

The HMC1041Z utilizes Honeywell's Anisotropic Magnetoresistive (AMR) technology that provides advantages over coil based magnetic sensors. They are extremely sensitive, low field, solid-state magnetic sensors designed to measure direction and magnitude of Earth's magnetic fields, from tens of micro-gauss to 6 gauss. Honeywell's Magnetic Sensors are among the most sensitive and reliable low-field sensors in the industry.

Honeywell continues to maintain product excellence and performance by introducing innovative solid-state magnetic sensor solutions. These are highly reliable, top performance products that are delivered when promised. Honeywell's magnetic sensor solutions provide real solutions you can count on.

FEATURES

- ▶ Low Height Magnetic Sensors (1.05mm)
- ▶ Surface Mount Z-Axis Sensor
- ▶ Low Voltage Operations (2.0V)
- ▶ Low Cost
- ▶ Available in Tape & Reel Packaging
- ▶ Lead Free Package Construction
- ▶ 4-Element Wheatstone Bridge
- ▶ Wide Magnetic Field Range (+/-6 Oe)
- ▶ Patented Offset and Set/Reset Straps

BENEFITS

- ▶ Narrow Dimensions and Small Size for Low Profile Vertical Sensing Applications and Mounting, No Layout Constraints
- ▶ Easy to Assemble & Compatible with High Speed SMT Assembly
- ▶ Compatible for Battery Powered Applications
- ▶ Designed for High Volume, Cost Effective OEM Designs
- ▶ High Volume OEM Assembly
- ▶ Complies with Current Environmental Standards
- ▶ Low Noise Passive Element Design
- ▶ Sensor Can Be Used in Strong Magnetic Field Environments
- ▶ Stray Magnetic Field Compensation

HMC1041Z

SPECIFICATIONS

Characteristics	Conditions*	Min	Typ	Max	Units
Bridge Elements					
Supply	Vbridge referenced to GND	2.0	5.0	20	Volts
Resistance	Bridge current = 1mA	800	1050	1300	ohms
Field Range	Full scale (FS) – total applied field	-6		+6	gauss
Sensitivity	Set/Reset Current = 0.5A	0.8	1.0	1.25	mV/V/gauss
Resolution	1 kHz bandwidth, Vbridge = 5.0 volts		0.16 1.44		milli-gauss (RMS) milli-gauss (pk – pk)
Bridge Offset	Offset = (OUT+) – (OUT-) Field = 0 gauss after Set pulse	-2.0	±0.5	+2.0	mV/V
Bandwidth	Magnetic signal (lower limit = DC)		5		MHz
Disturbing Field	Sensitivity starts to degrade. Use S/R pulse to restore sensitivity.			20	gauss
Max. Exposed Field	No perming effect on zero reading			10000	gauss
Operating Temperature	Ambient	-40		125	°C
Storage Temperature	Ambient, unbiased	-55		125	°C
Sensitivity Tempco	T _A = -40 to 125°C, Vbridge=5V	-3500	-3100	-2000	ppm/°C
Bridge Offset Tempco	T _A = -40 to 125°C, No Set/Reset T _A = -40 to 125°C, With Set/Reset		±500 ±10		ppm/°C
Bridge Ohmic Tempco	Vbridge=5V, T _A = -40 to 125°C	2100	2500	2900	ppm/°C
Cross-Axis Sensitivity	Cross field = 0.5 gauss, H _{applied} = ±3 gauss		±0.5%		%FS/gauss
Linearity Error	Best fit straight line ± 1 gauss ± 3 gauss ± 6 gauss		0.17 0.42 0.80		%FS
Hysteresis Error	3 sweeps across ±3 gauss		0.15		%FS
Repeatability Error	3 sweeps across ±3 gauss		0.11		%FS
Weight			8.9		milli-grams

Set/Reset Strap

Resistance	Measured from S/R+ to S/R-	3	5	6	ohms
Current	0.1% duty cycle, or less, 2µsec current pulse	0.4	0.5	2	Amp
Resistance Tempco	T _A =-40 to 125°C	3000	3900	4500	ppm/°C

Offset Straps

Resistance	Measured from OFFSET+ to OFFSET-	5	8	11	ohms
Offset Constant	DC Current Field applied in sensitive direction		10		mA/gauss
Resistance Tempco	T _A =-40 to 125°C	1800	2700	4500	ppm/°C

* Tested at 25°C except stated otherwise.

HMC1041Z

SCHEMATIC DIAGRAM

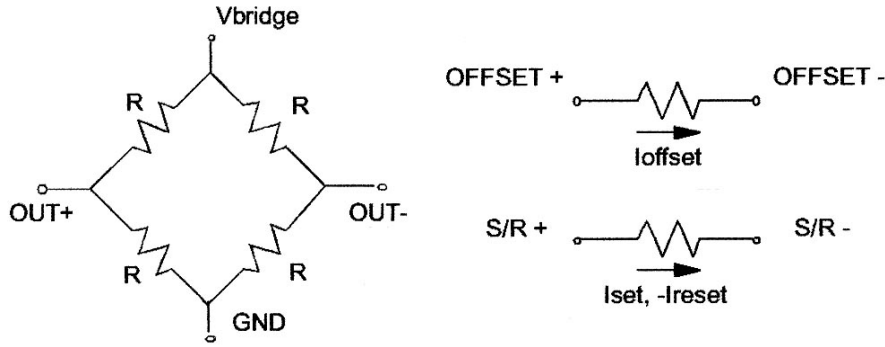

PIN CONFIGURATIONS

(Arrow indicates direction of applied field that generates a positive output voltage after a SET pulse.)

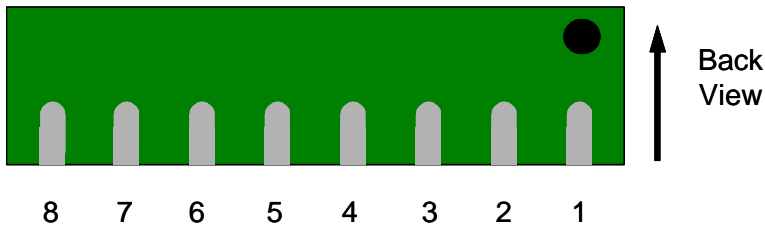

PIN NUMBER	FUNCTION
1	OFFSET-
2	VBRIDGE
3	OFFSET+
4	OUT+
5	OUT-
6	GND
7	S/R-
8	S/R+

PACKAGE OUTLINES

PACKAGE DRAWING HMC1041Z (8-PIN LQFP, dimensions in millimeters)

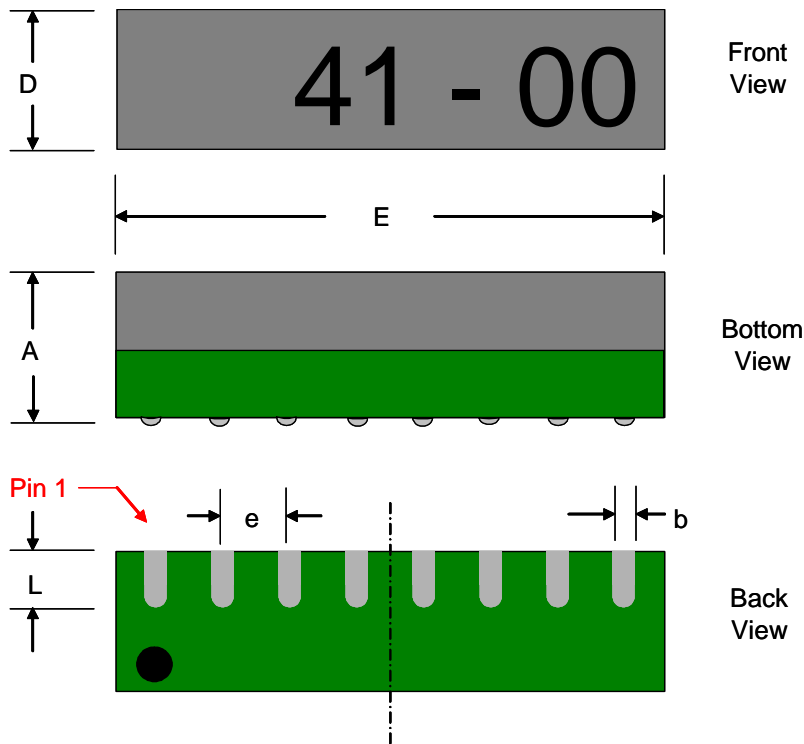

Dimension	Millimeters		
	Min	Nom	Max
D	0.95	1.05	1.15
E	4.00	4.10	4.20
A	0.91	1.08	1.25
b	0.17	0.20	0.23
L	0.37	0.40	0.43
e	0.5 basic		

HMC1041Z

MOUNTING CONSIDERATIONS

The following is the recommend printed circuit board (PCB) footprint for the HMC1041Z. The two small (0.5mm by 0.5mm) leveling pads are to hold the part square to the PCB and should receive the same pad finish as the rest of the pads but without additional solder paste. The goal is to hold the part vertical surfaces perpendicular to the board surface. All dimensions are nominal and in millimeters.

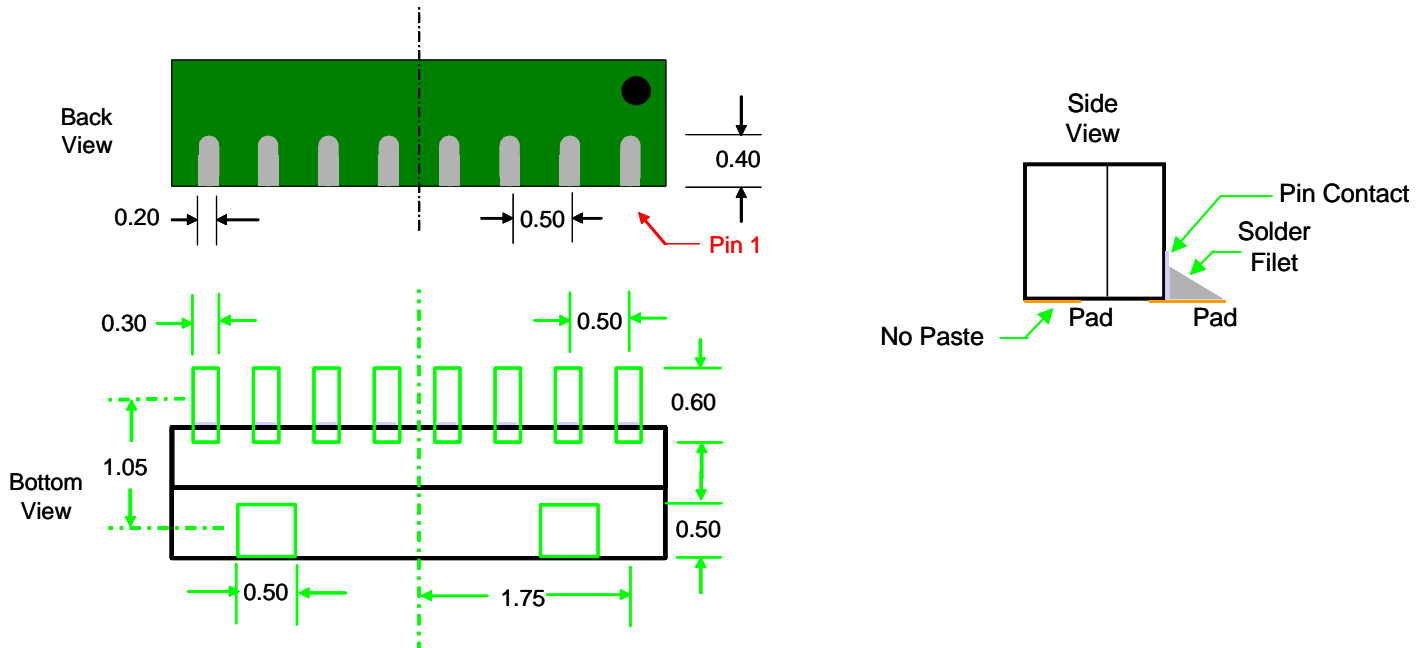

Stencil Design and Solder Paste

A 4 mil stencil and 100% paste coverage is recommended for the eight electrical contact pads. Do not apply paste on the leveling pads. The HMC1041Z has been tested successfully with no-clean solder paste.

Pick and Place

Placement is machine dependant and no restrictions are recommended, and have be tested with mechanical centering. Placement force should be equivalent 1206 SMT resistors and enough force should be used to squeeze the paste out from the package/contact pad overlap and to keep the package pin contacts vertical. The low mass of the HMC1041Z ensures that very little paste is required to hold the part until reflow.

Reflow and Rework

No special profile is required for the HMC1041Z, and compatible with lead eutectic and lead-free solder paste reflow profiles. Honeywell recommends the adherence to solder paste manufacturer's guidelines. The HMC1041Z may be reworked with soldering irons, but extreme care must be taken not to overheat the copper pads from the part's fiberglass substrate. Irons with a tip temperature no greater than 315°C should be used. Excessive rework risks the copper pads pulling away into the molten solder.

BASIC DEVICE OPERATION

The Honeywell HMC1041Z magnetoresistive sensor is a Wheatstone bridge device to measure magnetic fields. With power supply applied to a bridge, the sensor converts any incident magnetic field in the sensitive axis direction to a differential voltage output. In addition to the bridge circuit, the sensor has two on-chip magnetically coupled straps; the offset strap and the set/reset strap. These straps are Honeywell patented features for incident field adjustment and magnetic domain alignment; and eliminate the need for external coils positioned around the sensors.

The magnetoresistive sensors are made of a nickel-iron (Permalloy) thin-film deposited on a silicon wafer and patterned as a resistive strip element. In the presence of a magnetic field, a change in the bridge resistive elements causes a corresponding change in voltage across the bridge outputs.

HMC1041Z

These resistive elements are aligned together to have a common sensitive axis (indicated by arrows on the pinouts) that will provide positive voltage change with magnetic fields increasing in the sensitive direction. Because the output only is in proportion to the one-dimensional axis (the principle of anisotropy) and its magnitude, additional sensor bridges placed at orthogonal directions permit accurate measurement of arbitrary field direction. The combination of sensor bridges in two and three orthogonal axis permit applications such as compassing and magnetometry.

The offset strap allows for several modes of operation when a direct current is driven through it. These modes are: 1) Subtraction (bucking) of an unwanted external magnetic field, 2) null-ing of the bridge offset voltage, 3) Closed loop field cancellation, and 4) Auto-calibration of bridge gain.

The set/reset strap can be pulsed with high currents for the following benefits: 1) Enable the sensor to perform high sensitivity measurements, 2) Flip the polarity of the bridge output voltage, and 3) Periodically used to improve linearity, lower cross-axis effects, and temperature effects.

Offset Strap

The offset strap is a spiral of metallization that couples in the sensor element's sensitive axis. The offset strap measures nominally 8 ohms, and requires 10mA for each gauss of induced field. The straps will easily handle currents to buck or boost fields through the ± 6 gauss linear measurement range, but designers should note the extreme thermal heating on the die when doing so.

With most applications, the offset strap is not utilized and can be ignored. Designers can leave one or both strap connections (Off- and Off+) open circuited, or ground one connection node. Do not tie both strap connections together to avoid shorted turn magnetic circuits.

Set/Reset Strap

The set/reset strap is another spiral of metallization that couples to the sensor elements easy axis (perpendicular to the sensitive axis on the sensor die). Each set/reset strap has a nominal resistance of 5 ohms with a nominal required peak current of 500mA for reset or set pulses. With rare exception, the set/reset strap must be used to periodically condition the magnetic domains of the magneto-resistive elements for best and reliable performance.

A set pulse is defined as a positive pulse current entering the S/R+ strap connection. The successful result would be the magnetic domains aligned in a forward easy-axis direction so that the sensor bridge's polarity is a positive slope with positive fields on the sensitive axis result in positive voltages across the bridge output connections.

A reset pulse is defined as a negative pulse current entering the S/R+ strap connection. The successful result would be the magnetic domains aligned in a reverse easy-axis direction so that sensor bridge's polarity is a negative slope with positive fields on the sensitive axis result in negative voltages across the bridge output connections.

Typically a reset pulse is sent first, followed by a set pulse a few milliseconds later. By shoving the magnetic domains in completely opposite directions, any prior magnetic disturbances are likely to be completely erased by the duet of pulses. For simpler circuits with less critical requirements for noise and accuracy, a single polarity pulse circuit may be employed (all sets or all resets). With these uni-polar pulses, several pulses together become close in performance to a set/reset pulse circuit. Figure 1 shows a quick and dirty manual pulse circuit for uni-polar application of pulses to the set/reset strap.

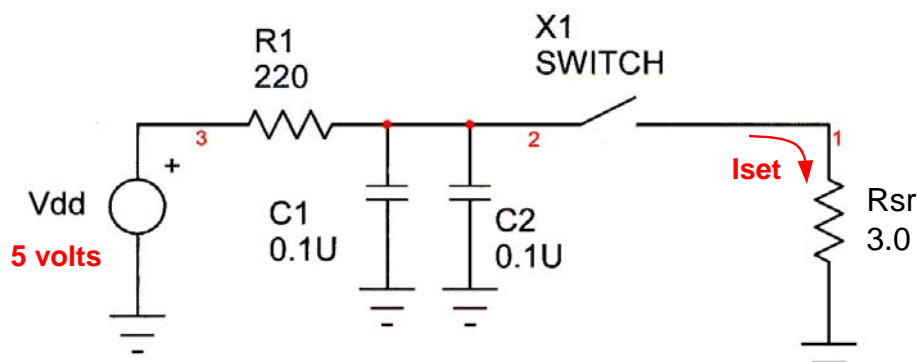

Figure 1
Manual Set Pulse Circuit

HMC1041Z

ORDERING INFORMATION

Ordering Number	Product
HMC1041Z	One Axis Magnetic Sensor
HMC1041Z T/R 3k	Tape and Reel 3k pieces/reel
HMC1041Z Cut Tape	Cut Tape

FIND OUT MORE

For more information on Honeywell's Magnetic Sensors visit us online at www.magneticsensors.com or contact us at 800-323-8295 (763-954-2474 internationally).

The application circuits herein constitute typical usage and interface of Honeywell product. Honeywell does not warranty or assume liability of customer-designed circuits derived from this description or depiction.

Honeywell reserves the right to make changes to improve reliability, function or design. Honeywell does not assume any liability arising out of the application or use of any product or circuit described herein; neither does it convey any license under its patent rights nor the rights of others.

U.S. Patents 4,441,072, 4,533,872, 4,569,742, 4,681,812, 4,847,584 and 6,529,114 apply to the technology described

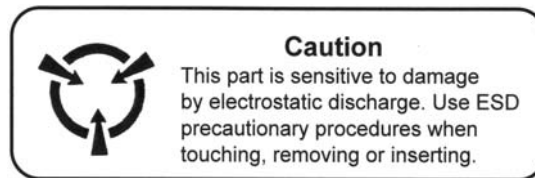

CAUTION: ESDS CAT. 1B

Honeywell
12001 Highway 55
Plymouth, MN 55441
Tel: 800-323-8295
www.honeywell.com/magneticsensors

Form #900314
April 2005
©2005 Honeywell International Inc.

Honeywell