

Dual, 128-Tap, Low Voltage Digitally Controlled Potentiometer (XDCP™)

ISL23328

The ISL23328 is a volatile, low voltage, low noise, low power, 128-Tap, dual digitally controlled potentiometer (DCP) with an I²C Bus™ interface. It integrates two DCP cores, wiper switches and control logic on a monolithic CMOS integrated circuit.

Each digitally controlled potentiometer is implemented with a combination of resistor elements and CMOS switches. The position of the wipers are controlled by the user through the I²C bus interface. Each potentiometer has an associated volatile Wiper Register (WRI, i = 0, 1) that can be directly written to and read by the user. The contents of the WRI controls the position of the wiper. When powered on, the wiper of each DCP will always commence at mid-scale (64 tap position).

The low voltage, low power consumption, and small package of the ISL23328 make it an ideal choice for use in battery operated equipment. In addition, the ISL23328 has a V_{LOGIC} pin allowing down to 1.2V bus operation, independent from the V_{CC} value. This allows for low logic levels to be connected directly to the ISL23328 without passing through a voltage level shifter.

The DCP can be used as a three-terminal potentiometer or as a two-terminal variable resistor in a wide variety of applications including control, parameter adjustments, and signal processing.

Applications

- Power supply margining
- Trimming sensor circuits
- Gain adjustment in battery powered instruments
- RF power amplifier bias compensation

Features

- Two potentiometers per package
- 128 resistor taps
- 10kΩ, 50kΩ or 100kΩ total resistance
- I²C serial interface
 - No additional level translator for low bus supply
 - Three address pins allow up to eight devices per bus
- Power supply
 - V_{CC} = 1.7V to 5.5V analog power supply
 - V_{LOGIC} = 1.2V to 5.5V I²C bus/logic power supply
- Maximum supply current without serial bus activity (standby)
 - 3μA @ V_{CC} and V_{LOGIC} = 5V
 - 1.7μA @ V_{CC} and V_{LOGIC} = 1.7V
- Shutdown Mode
 - Forces the DCP into an end-to-end open circuit and RWi is connected to RLi internally
 - Reduces power consumption by disconnecting the DCP resistor from the circuit
- Wiper resistance: 70Ω typical @ V_{CC} = 3.3V
- Power-on preset to mid-scale (64 tap position)
- Extended industrial temperature range: -40°C to +125°C
- 14 Ld TSSOP or 16 Ld UTQFN packages
- Pb-free (RoHS Compliant)

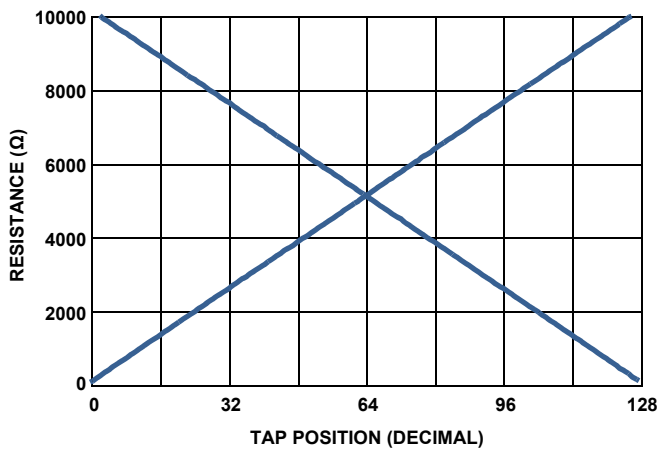

FIGURE 1. FORWARD AND BACKWARD RESISTANCE vs TAP POSITION, 10kΩ DCP

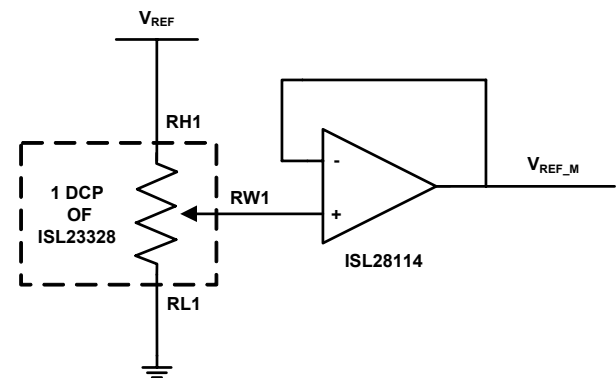
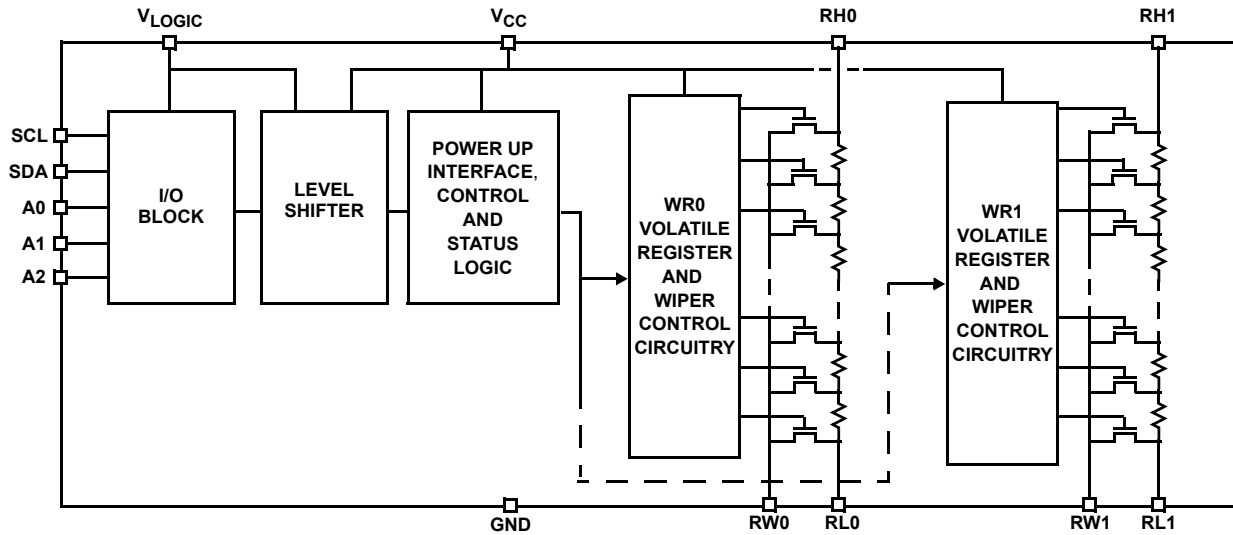

FIGURE 2. V_{REF} ADJUSTMENT

Block Diagram



Pin Configurations

ISL23328
(14 LD TSSOP)
TOP VIEW

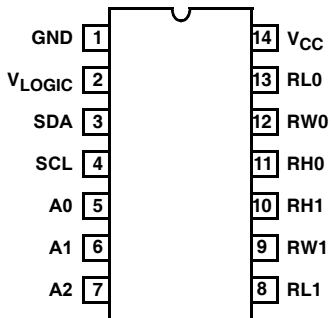

ISL23328
(16 LD UTQFN)
TOP VIEW

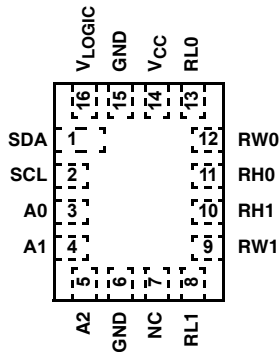

Pin Descriptions

| TSSOP | UTQFN | SYMBOL | DESCRIPTION |
|-------|-------|--------------------|--|
| 1 | 6, 15 | GND | Ground pin |
| 2 | 16 | V _{LOGIC} | I ² C bus/logic supply. Range 1.2V to 5.5V |
| 3 | 1 | SDA | Logic Pin - Serial bus data input/open drain output |
| 4 | 2 | SCL | Logic Pin - Serial bus clock input |
| 5 | 3 | A0 | Logic Pin - Hardwire slave address pin for I ² C serial bus. Range: V _{LOGIC} or GND |
| 6 | 4 | A1 | Logic Pin - Hardwire slave address pin for I ² C serial bus. Range: V _{LOGIC} or GND |
| 7 | 5 | A2 | Logic Pin - Hardwire slave address pin for I ² C serial bus. Range: V _{LOGIC} or GND |
| 8 | 8 | RL1 | DCP1 "low" terminal |
| 9 | 9 | RW1 | DCP1 wiper terminal |
| 10 | 10 | RH1 | DCP1 "high" terminal |
| 11 | 11 | RH0 | DCP0 "high" terminal |
| 12 | 12 | RW0 | DCP0 wiper terminal |
| 13 | 13 | RL0 | DCP0 "low" terminal |
| 14 | 14 | V _{CC} | Analog power supply. Range 1.7V to 5.5V |
| | 7 | NC | Not Connected |

Ordering Information

| PART NUMBER (Note 4) | PART MARKING | RESISTANCE OPTION (kΩ) | TEMP RANGE (°C) | PACKAGE (Pb-free) | PKG. DWG. # |
|--------------------------------|--------------|------------------------------|--------------------|----------------------|----------------|
| ISL23328TFVZ (Note 2) | 23328 TFVZ | 100 | -40 to +125 | 14 Ld TSSOP | M14.173 |
| ISL23328TFVZ-T7A (Notes 1, 2) | 23328 TFVZ | 100 | -40 to +125 | 14 Ld TSSOP | M14.173 |
| ISL23328TFVZ-TK (Notes 1, 2) | 23328 TFVZ | 100 | -40 to +125 | 14 Ld TSSOP | M14.173 |
| ISL23328UFVZ (Note 2) | 23328 UFVZ | 50 | -40 to +125 | 14 Ld TSSOP | M14.173 |
| ISL23328UFVZ-T7A (Notes 1, 2) | 23328 UFVZ | 50 | -40 to +125 | 14 Ld TSSOP | M14.173 |
| ISL23328UFVZ-TK (Notes 1, 2) | 23328 UFVZ | 50 | -40 to +125 | 14 Ld TSSOP | M14.173 |
| ISL23328WVZ (Note 2) | 23328 WVZ | 10 | -40 to +125 | 14 Ld TSSOP | M14.173 |
| ISL23328WVZ-T7A (Notes 1, 2) | 23328 WVZ | 10 | -40 to +125 | 14 Ld TSSOP | M14.173 |
| ISL23328WVZ-TK (Notes 1, 2) | 23328 WVZ | 10 | -40 to +125 | 14 Ld TSSOP | M14.173 |
| ISL23328TFRUZ-T7A (Notes 1, 3) | GBM | 100 | -40 to +125 | 16 Ld 2.6x1.8 UTQFN | L16.2.6x1.8A |
| ISL23328TFRUZ-TK (Notes 1, 3) | GBM | 100 | -40 to +125 | 16 Ld 2.6x1.8 UTQFN | L16.2.6x1.8A |
| ISL23328UFRUZ-T7A (Notes 1, 3) | GBL | 50 | -40 to +125 | 16 Ld 2.6x1.8 UTQFN | L16.2.6x1.8A |
| ISL23328UFRUZ-TK (Notes 1, 3) | GBL | 50 | -40 to +125 | 16 Ld 2.6x1.8 UTQFN | L16.2.6x1.8A |
| ISL23328WFRUZ-T7A (Notes 1, 3) | GBK | 10 | -40 to +125 | 16 Ld 2.6x1.8 UTQFN | L16.2.6x1.8A |
| ISL23328WFRUZ-TK (Notes 1, 3) | GBK | 10 | -40 to +125 | 16 Ld 2.6x1.8 UTQFN | L16.2.6x1.8A |

NOTES:

1. Please refer to [IB347](#) for details on reel specifications.
2. These Intersil Pb-free plastic packaged products employ special Pb-free material sets, molding compounds/die attach materials, and 100% matte tin plate plus anneal (e3 termination finish, which is RoHS compliant and compatible with both SnPb and Pb-free soldering operations). Intersil Pb-free products are MSL classified at Pb-free peak reflow temperatures that meet or exceed the Pb-free requirements of IPC/JEDEC J STD-020.
3. These Intersil Pb-free plastic packaged products employ special Pb-free material sets; molding compounds/die attach materials and NiPdAu plate - e4 termination finish, which is RoHS compliant and compatible with both SnPb and Pb-free soldering operations. Intersil Pb-free products are MSL classified at Pb-free peak reflow temperatures that meet or exceed the Pb-free requirements of IPC/JEDEC J STD-020.
4. For Moisture Sensitivity Level (MSL), please see device information page for [ISL23328](#). For more information on MSL please see techbrief [TB363](#).

ISL23328

Absolute Maximum Ratings

| | |
|--|----------------|
| Supply Voltage Range | |
| V_{CC} | -0.3V to 6.0V |
| V_{LOGIC} | -0.3V to 6.0V |
| Voltage on Any DCP Terminal Pin | -0.3V to 6.0V |
| Voltage on Any Digital Pins | -0.3V to 6.0V |
| Wiper Current I_W (10s) | ± 6 mA |
| ESD Rating | |
| Human Body Model (Tested per JESD22-A114E) | 4.5kV |
| Charged Device Model (Tested per JESD22-A114E) | 1kV |
| Machine Model (Tested per JESD22-A115-A) | 300V |
| Latch Up (Tested per JESD-78B; Class 2, Level A) | 100mA @ +125°C |

Thermal Information

| | | |
|--|---|----------------------|
| Thermal Resistance (Typical) | θ_{JA} (°C/W) | θ_{JC} (°C/W) |
| 14 Ld TSSOP Package (Notes 5, 6) | 112 | 40 |
| 16 Ld UTQFN Package (Notes 5, 6) | 110 | 64 |
| Maximum Junction Temperature (Plastic Package) | +150°C | |
| Storage Temperature Range | -65°C to +150°C | |
| Pb-Free Reflow Profile | see link below | |
| | http://www.intersil.com/pbfree/Pb-FreeReflow.asp | |

Recommended Operating Conditions

| | |
|----------------------------|-----------------|
| Temperature | -40°C to +125°C |
| V_{CC} Supply Voltage | 1.7V to 5.5V |
| V_{LOGIC} Supply Voltage | 1.2V to 5.5V |
| DCP Terminal Voltage | 0 to V_{CC} |
| Max Wiper Current | ± 3 mA |

CAUTION: Do not operate at or near the maximum ratings listed for extended periods of time. Exposure to such conditions may adversely impact product reliability and result in failures not covered by warranty.

NOTES:

- θ_{JA} is measured with the component mounted on a high effective thermal conductivity test board in free air. See Tech Brief [TB379](#) for details.
- For θ_{JC} , the "case temp" location is the center top of the package.

Analog Specifications $V_{CC} = 2.7V$ to 5.5V, $V_{LOGIC} = 1.2V$ to 5.5V over recommended operating conditions unless otherwise stated.
Boldface limits apply over the operating temperature range, -40°C to +125°C.

| SYMBOL | PARAMETER | TEST CONDITIONS | MIN (Note 19) | TYP (Note 7) | MAX (Note 19) | UNITS | |
|------------------|--|--|------------------|-----------------|----------------------------|-----------------|--------|
| R_{TOTAL} | RH to RL Resistance | W option | | 10 | | k Ω | |
| | | U option | | 50 | | k Ω | |
| | | T option | | 100 | | k Ω | |
| | RH to RL Resistance Tolerance | | -20 | ± 2 | +20 | % | |
| | End-to-End Temperature Coefficient | W option | | | 125 | | ppm/°C |
| | | U option | | | 65 | | ppm/°C |
| T option | | | | 45 | | ppm/°C | |
| V_{RH}, V_{RL} | DCP Terminal Voltage | V_{RH} or V_{RL} to GND | 0 | | V_{CC} | V | |
| RW | Wiper Resistance | RH - floating, $V_{RL} = 0V$, force I_W current to the wiper, $I_W = (V_{CC} - V_{RL})/R_{TOTAL}$, $V_{CC} = 2.7V$ to 5.5V | | 70 | 200 | Ω | |
| | | $V_{CC} = 1.7V$ | | 580 | | Ω | |
| $C_H/C_L/C_W$ | Terminal Capacitance | See "DCP Macro Model" on page 9 | | 32/32/32 | | pF | |
| I_{LkgDCP} | Leakage on DCP Pins | Voltage at pin from GND to V_{CC} | -0.4 | <0.1 | 0.4 | μA | |
| Noise | Resistor Noise Density | Wiper at middle point, W option | | 16 | | nV/ \sqrt{Hz} | |
| | | Wiper at middle point, U option | | 49 | | nV/ \sqrt{Hz} | |
| | | Wiper at middle point, T option | | 61 | | nV/ \sqrt{Hz} | |
| Feed Thru | Digital Feed-through from Bus to Wiper | Wiper at middle point | | -65 | | dB | |
| PSRR | Power Supply Reject Ratio | Wiper output change if V_{CC} change $\pm 10\%$; wiper at middle point | | -75 | | dB | |

ISL23328

Analog Specifications $V_{CC} = 2.7V$ to $5.5V$, $V_{LOGIC} = 1.2V$ to $5.5V$ over recommended operating conditions unless otherwise stated.
Boldface limits apply over the operating temperature range, $-40^{\circ}C$ to $+125^{\circ}C$. (Continued)

| SYMBOL | PARAMETER | TEST CONDITIONS | MIN (Note 19) | TYP (Note 7) | MAX (Note 19) | UNITS |
|--|--|---|------------------|-----------------|------------------|------------------|
| VOLTAGE DIVIDER MODE (0V @ RL; V_{CC} @ RH; measured at RW, unloaded) | | | | | | |
| INL (Note 12) | Integral Non-linearity, Guaranteed Monotonic | W option | -0.5 | ± 0.15 | +0.5 | LSB (Note 8) |
| | | U, T option | -0.5 | ± 0.15 | +0.5 | LSB (Note 8) |
| DNL (Note 11) | Differential Non-linearity, Guaranteed Monotonic | W option | -0.5 | ± 0.15 | +0.5 | LSB (Note 8) |
| | | U, T option | -0.5 | ± 0.15 | +0.5 | LSB (Note 8) |
| FSerror | Full-scale Error | W option | -3 | -1.5 | 0 | LSB (Note 8) |
| | | U, T option | -1.5 | -0.9 | 0 | LSB (Note 8) |
| ZSerror (Note 9) | Zero-scale Error | W option | 0 | 1.5 | 3 | LSB (Note 8) |
| | | U, T option | 0 | 0.9 | 1.5 | LSB (Note 8) |
| Vmatch (Note 21) | DCP to DCP Matching | DCPs at same tap position, same voltage at all RH terminals, and same voltage at all RL terminals | -2 | ± 0.5 | 2 | LSB (Note 8) |
| TC _v (Notes 13) | Ratiometric Temperature Coefficient | W option, Wiper Register set to 40 hex | | 8 | | ppm/ $^{\circ}C$ |
| | | U option, Wiper Register set to 40 hex | | 4 | | ppm/ $^{\circ}C$ |
| | | T option, Wiper Register set to 40 hex | | 2.3 | | ppm/ $^{\circ}C$ |
| t _{LS_Setting} | Large Signal Wiper Settling Time | From code 0 to 7F hex, measured from 0 to 1 LSB settling of the wiper | | 300 | | ns |
| f _{cutoff} | -3dB Cutoff Frequency | Wiper at middle point W option | | 1200 | | kHz |
| | | Wiper at middle point U option | | 250 | | kHz |
| | | Wiper at middle point T option | | 120 | | kHz |
| RHEOSTAT MODE (Measurements between RW and RL pins with RH not connected, or between RW and RH with RL not connected) | | | | | | |
| R _{INL} (Note 17) | Integral Non-linearity, Guaranteed Monotonic | W option; $V_{CC} = 2.7V$ to $5.5V$ | -1.0 | ± 0.5 | +1.0 | MI (Note 14) |
| | | W option; $V_{CC} = 1.7V$ | | 4 | | MI (Note 14) |
| | | U, T option; $V_{CC} = 2.7V$ to $5.5V$ | -0.5 | ± 0.15 | +0.5 | MI (Note 14) |
| | | U, T option; $V_{CC} = 1.7V$ | | 1 | | MI (Note 14) |
| R _{DNL} (Note 16) | Differential Non-linearity, Guaranteed Monotonic | W option; $V_{CC} = 2.7V$ to $5.5V$ | -0.5 | ± 0.15 | +0.5 | MI (Note 14) |
| | | W option; $V_{CC} = 1.7V$ | | ± 0.4 | | MI (Note 14) |
| | | U, T option; $V_{CC} = 2.7V$ to $5.5V$ | -0.5 | ± 0.15 | +0.5 | MI (Note 14) |
| | | U, T option; $V_{CC} = 1.7V$ | | ± 0.4 | | MI (Note 14) |

ISL23328

Analog Specifications $V_{CC} = 2.7V$ to $5.5V$, $V_{LOGIC} = 1.2V$ to $5.5V$ over recommended operating conditions unless otherwise stated.
Boldface limits apply over the operating temperature range, $-40^{\circ}C$ to $+125^{\circ}C$. (Continued)

| SYMBOL | PARAMETER | TEST CONDITIONS | MIN (Note 19) | TYP (Note 7) | MAX (Note 19) | UNITS |
|----------------------------------|------------------------------------|---|------------------|-----------------|------------------|------------------|
| R _{offset} (Note 15) | Offset, Wiper at 0 Position | W option; $V_{CC} = 2.7V$ to $5.5V$ | 0 | 1.8 | 3 | MI (Note 14) |
| | | W option; $V_{CC} = 1.7V$ | | 3 | | MI (Note 14) |
| | | U, T option; $V_{CC} = 2.7V$ to $5.5V$ | 0 | 0.3 | 1 | MI (Note 14) |
| | | U, T option; $V_{CC} = 1.7V$ | | 0.5 | | MI (Note 14) |
| R _{match} (Note 22) | DCP to DCP Matching | Any two DCPs at the same tap position with the same terminal voltages | -2 | | 2 | LSB (Note 8) |
| TCR (Note 18) | Resistance Temperature Coefficient | W option; Wiper register set between 19 hex and 7F hex | | 170 | | ppm/ $^{\circ}C$ |
| | | U option; Wiper register set between 19 hex and 7F hex | | 80 | | ppm/ $^{\circ}C$ |
| | | T option; Wiper register set between 19 hex and 7F hex | | 50 | | ppm/ $^{\circ}C$ |

Operating Specifications $V_{CC} = 2.7V$ to $5.5V$, $V_{LOGIC} = 1.2V$ to $5.5V$ over recommended operating conditions unless otherwise stated.
Boldface limits apply over the operating temperature range, $-40^{\circ}C$ to $+125^{\circ}C$.

| SYMBOL | PARAMETER | TEST CONDITIONS | MIN (Note 19) | TYP (Note 7) | MAX (Note 19) | UNITS |
|-------------------------|--|---|------------------|-----------------|------------------|---------|
| I _{LOGIC} | V _{LOGIC} Supply Current (Write/Read) | V _{LOGIC} = 5.5V, V _{CC} = 5.5V, f _{SCL} = 400kHz (for I ² C active read and write) | | | 200 | μA |
| | | V _{LOGIC} = 1.2V, V _{CC} = 1.7V, f _{SCL} = 400kHz (for I ² C active read and write) | | | 5 | μA |
| I _{CC} | V _{CC} Supply Current (Write/Read) | V _{LOGIC} = 5.5V, V _{CC} = 5.5V | | | 18 | μA |
| | | V _{LOGIC} = 1.2V, V _{CC} = 1.7V | | | 10 | μA |
| I _{LOGIC SB} | V _{LOGIC} Standby Current | V _{LOGIC} = V _{CC} = 5.5V, I ² C interface in standby | | | 1 | μA |
| | | V _{LOGIC} = 1.2V, V _{CC} = 1.7V, I ² C interface in standby | | | 0.5 | μA |
| I _{CC SB} | V _{CC} Standby Current | V _{LOGIC} = V _{CC} = 5.5V, I ² C interface in standby | | | 2 | μA |
| | | V _{LOGIC} = 1.2V, V _{CC} = 1.7V, I ² C interface in standby | | | 1.2 | μA |
| I _{LOGIC SHDN} | V _{LOGIC} Shutdown Current | V _{LOGIC} = V _{CC} = 5.5V, I ² C interface in standby | | | 1 | μA |
| | | V _{LOGIC} = 1.2V, V _{CC} = 1.7V, I ² C interface in standby | | | 0.5 | μA |
| I _{CC SHDN} | V _{CC} Shutdown Current | V _{LOGIC} = V _{CC} = 5.5V, I ² C interface in standby | | | 2 | μA |
| | | V _{LOGIC} = 1.2V, V _{CC} = 1.7V, I ² C interface in standby | | | 1.2 | μA |
| I _{LkgDig} | Leakage Current, at Pins A0, A1, A2, SDA, SCL | Voltage at pin from GND to V _{LOGIC} | -0.4 | <0.1 | 0.4 | μA |

ISL23328

Operating Specifications $V_{CC} = 2.7V$ to $5.5V$, $V_{LOGIC} = 1.2V$ to $5.5V$ over recommended operating conditions unless otherwise stated. Boldface limits apply over the operating temperature range, $-40^{\circ}C$ to $+125^{\circ}C$. (Continued)

| SYMBOL | PARAMETER | TEST CONDITIONS | MIN (Note 19) | TYP (Note 7) | MAX (Note 19) | UNITS |
|--|------------------------------------|--|------------------|-----------------|------------------|---------|
| t_{DCP} | Wiper Response Time | W option; SCL rising edge of the acknowledge bit after data byte to wiper new position from 10% to 90% of the final value. | | 0.4 | | μs |
| | | U option; SCL rising edge of the acknowledge bit after data byte to wiper new position from 10% to 90% of the final value. | | 1.5 | | μs |
| | | T option; SCL rising edge of the acknowledge bit after data byte to wiper new position from 10% to 90% of the final value. | | 3.5 | | μs |
| $t_{ShdnRec}$ | DCP Recall Time from Shutdown Mode | SCL rising edge of the acknowledge bit after ACR data byte to wiper recalled position and RH connection | | 1.5 | | μs |
| V_{CC}, V_{LOGIC} Ramp (Note 20) | V_{CC}, V_{LOGIC} Ramp Rate | Ramp monotonic at any level | 0.01 | | 50 | V/ms |

Serial Interface Specification For SCL, SDA, A0, A1, A2 unless otherwise noted.

| SYMBOL | PARAMETER | TEST CONDITIONS | MIN (Note 19) | TYP (Note 7) | MAX (Note 19) | UNITS |
|--------------|--|--|-------------------------|-----------------|------------------------|-------|
| V_{IL} | Input LOW Voltage | | -0.3 | | $0.3 \times V_{LOGIC}$ | V |
| V_{IH} | Input HIGH Voltage | | $0.7 \times V_{LOGIC}$ | | $V_{LOGIC} + 0.3$ | V |
| Hysteresis | SDA and SCL Input Buffer Hysteresis | $V_{LOGIC} > 2V$ | $0.05 \times V_{LOGIC}$ | | | V |
| | | $V_{LOGIC} < 2V$ | $0.1 \times V_{LOGIC}$ | | | V |
| V_{OL} | SDA Output Buffer LOW Voltage | $I_{OL} = 3mA, V_{LOGIC} > 2V$ | 0 | | 0.4 | V |
| | | $I_{OL} = 1.5mA, V_{LOGIC} < 2V$ | | | $0.2 \times V_{LOGIC}$ | V |
| C_{pin} | SDA, SCL Pin Capacitance | | | 10 | | pF |
| f_{SCL} | SCL Frequency | | | | 400 | kHz |
| t_{sp} | Pulse Width Suppression Time at SDA and SCL Inputs | Any pulse narrower than the max spec is suppressed | | | 50 | ns |
| t_{AA} | SCL Falling Edge to SDA Output Data Valid | SCL falling edge crossing 30% of V_{LOGIC} , until SDA exits the 30% to 70% of V_{LOGIC} window | | | 900 | ns |
| t_{BUF} | Time the Bus Must be Free Before the Start of a New Transmission | SDA crossing 70% of V_{LOGIC} during a STOP condition, to SDA crossing 70% of V_{LOGIC} during the following START condition | 1300 | | | ns |
| t_{LOW} | Clock LOW Time | Measured at the 30% of V_{LOGIC} crossing | 1300 | | | ns |
| t_{HIGH} | Clock HIGH Time | Measured at the 70% of V_{LOGIC} crossing | 600 | | | ns |
| $t_{SU:STA}$ | START Condition Set-up Time | SCL rising edge to SDA falling edge; both crossing 70% of V_{LOGIC} | 600 | | | ns |

Serial Interface Specification For SCL, SDA, A0, A1, A2 unless otherwise noted. (Continued)

| SYMBOL | PARAMETER | TEST CONDITIONS | MIN (Note 19) | TYP (Note 7) | MAX (Note 19) | UNITS |
|---------------------|--|---|---------------------------|-----------------|------------------|-------|
| t _{HD:STA} | START Condition Hold Time | From SDA falling edge crossing 30% of V _{LOGIC} to SCL falling edge crossing 70% of V _{LOGIC} | 600 | | | ns |
| t _{SU:DAT} | Input Data Set-up Time | From SDA exiting the 30% to 70% of V _{LOGIC} window, to SCL rising edge crossing 30% of V _{LOGIC} | 100 | | | ns |
| t _{HD:DAT} | Input Data Hold Time | From SCL falling edge crossing 70% of V _{LOGIC} to SDA entering the 30% to 70% of V _{LOGIC} window | 0 | | | ns |
| t _{SU:STO} | STOP Condition Set-up Time | From SCL rising edge crossing 70% of V _{LOGIC} , to SDA rising edge crossing 30% of V _{LOGIC} | 600 | | | ns |
| t _{HD:STO} | STOP Condition Hold Time for Read or Write | From SDA rising edge to SCL falling edge; both crossing 70% of V _{LOGIC} | 1300 | | | ns |
| t _{DH} | Output Data Hold Time | From SCL falling edge crossing 30% of V _{LOGIC} , until SDA enters the 30% to 70% of V _{LOGIC} window. I _{OL} = 3mA, V _{LOGIC} > 2V. I _{OL} = 0.5mA, V _{LOGIC} < 2V | 0 | | | ns |
| t _R | SDA and SCL Rise Time | From 30% to 70% of V _{LOGIC} | 20 + 0.1 x C _b | | 250 | ns |
| t _F | SDA and SCL Fall Time | From 70% to 30% of V _{LOGIC} | 20 + 0.1 x C _b | | 250 | ns |
| C _b | Capacitive Loading of SDA or SCL | Total on-chip and off-chip | 10 | | 400 | pF |
| t _{SU:A} | A2, A1, A0 Setup Time | Before START condition | 600 | | | ns |
| t _{HD:A} | A2, A1, A0 Hold Time | After STOP condition | 600 | | | ns |

NOTES:

- Typical values are for T_A = +25 °C and 3.3V supply voltages.
- LSB = [V(RW)₁₂₇ - V(RW)₀]/127. V(RW)₁₂₇ and V(RW)₀ are V(RW) for the DCP register set to 7F hex and 00 hex respectively. LSB is the incremental voltage when changing from one tap to an adjacent tap.
- ZS error = V(RW)₀/LSB.
- FS error = [V(RW)₁₂₇ - V_{CC}]/LSB.
- DNL = [V(RW)_i - V(RW)_{i-1}]/LSB-1, for i = 1 to 127. i is the DCP register setting.
- INL = [V(RW)_i - i • LSB - V(RW)₀]/LSB for i = 1 to 127
- $TC_V = \frac{\text{Max}(V(RW)_i) - \text{Min}(V(RW)_i)}{V(RW)_i(+25^\circ\text{C})} \times \frac{10^6}{+165^\circ\text{C}}$ For i = 8 to 127 decimal, T = -40 °C to +125 °C. Max() is the maximum value of the wiper voltage and Min() is the minimum value of the wiper voltage over the temperature range.
- MI = |RW₁₂₇ - RW₀]/127. MI is a minimum increment. RW₁₂₇ and RW₀ are the measured resistances for the DCP register set to 7F hex and 00 hex respectively.
- Roffset = RW₀/MI, when measuring between RW and RL.
Roffset = RW₁₂₇/MI, when measuring between RW and RH.
- RDNL = (RW_i - RW_{i-1})/MI -1, for i = 8 to 127.
- RINL = [RW_i - (MI • i) - RW₀]/MI, for i = 8 to 127.
- $TC_R = \frac{[\text{Max}(R_i) - \text{Min}(R_i)]}{R_i(+25^\circ\text{C})} \times \frac{10^6}{+165^\circ\text{C}}$ for i = 8 to 127, T = -40 °C to +125 °C. Max() is the maximum value of the resistance and Min() is the minimum value of the resistance over the temperature range.
- Compliance to datasheet limits is assured by one or more methods: production test, characterization and/or design.
- It is preferable to ramp up both the V_{LOGIC} and the V_{CC} supplies at the same time. If this is not possible, it is recommended to ramp-up the V_{LOGIC} first followed by the V_{CC}.
- VMATCH = [V(RW_x)_i - V(RW_y)_i]/LSB, for i = 1 to 127, x = 0 to 1 and y = 0 to 1.
- RMATCH = (RW_{i,x} - RW_{i,y})/MI, for i = 1 to 127, x = 0 to 1 and y = 0 to 1.

DCP Macro Model

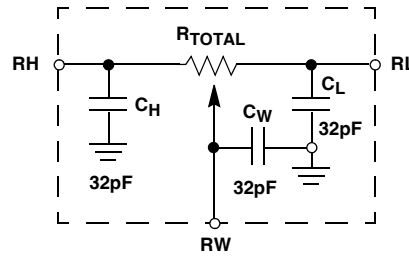

Timing Diagrams

SDA vs SCL Timing

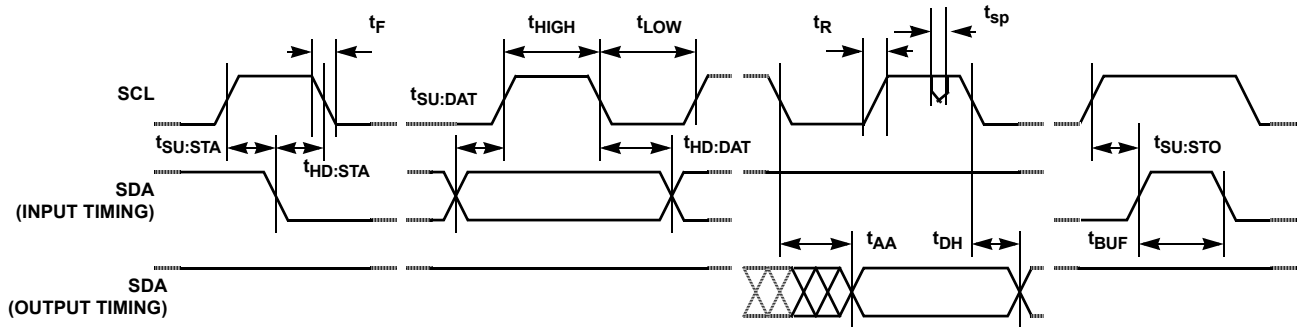

A0, A1, and A2 Pin Timing

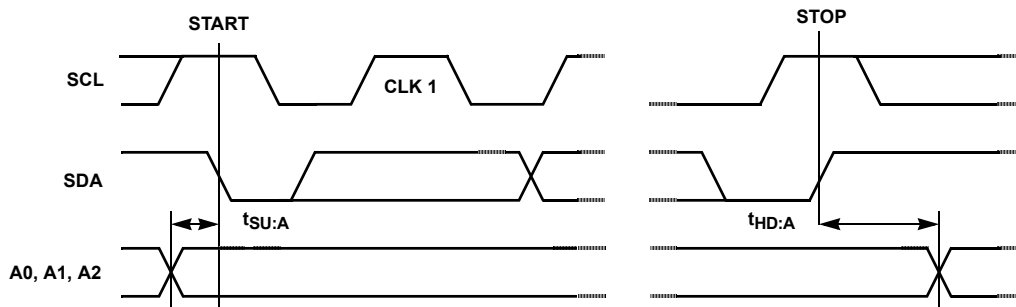

Typical Performance Curves

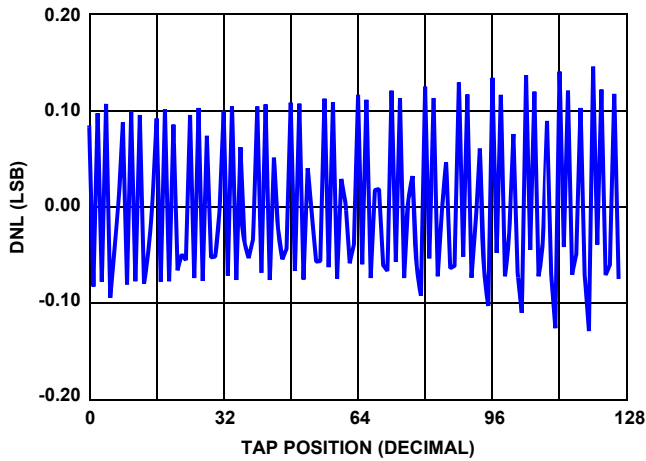

FIGURE 3. 10kΩ DNL vs TAP POSITION, $V_{CC} = 3.3V, +25^{\circ}C$

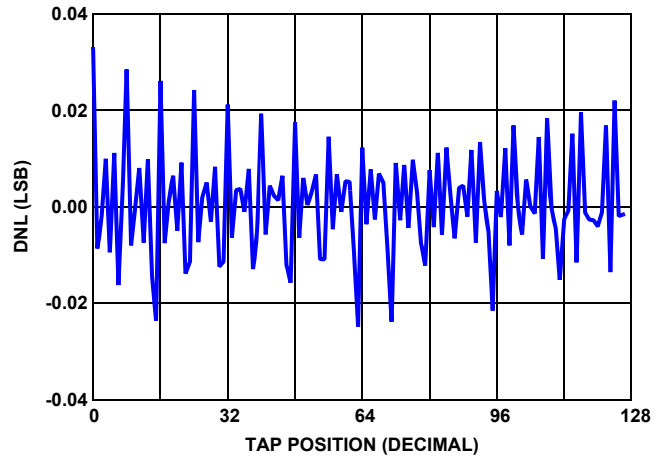

FIGURE 4. 50kΩ DNL vs TAP POSITION, $V_{CC} = 3.3V, +25^{\circ}C$

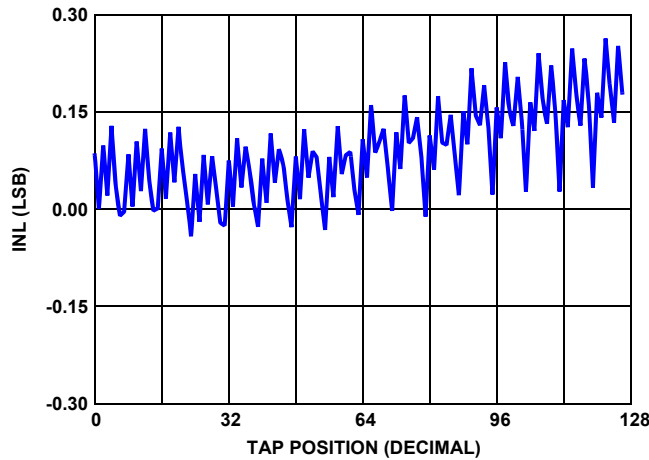

FIGURE 5. 10kΩ INL vs TAP POSITION, $V_{CC} = 3.3V, +25^{\circ}C$

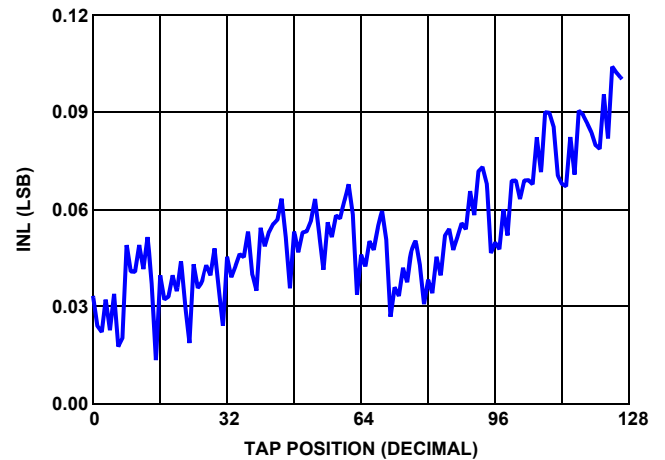

FIGURE 6. 50kΩ INL vs TAP POSITION, $V_{CC} = 3.3V, +25^{\circ}C$

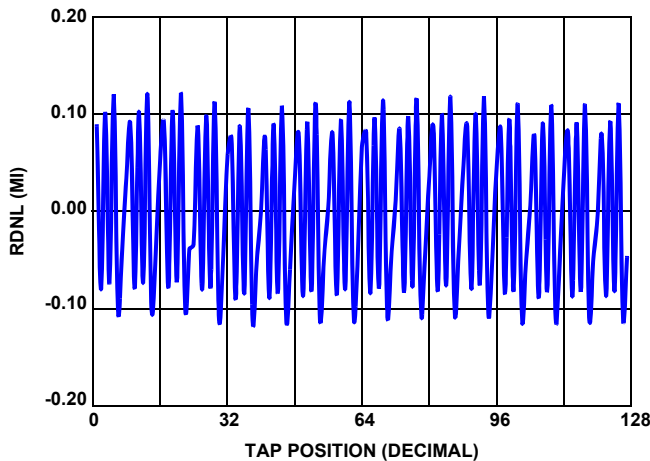

FIGURE 7. 10kΩ RDNL vs TAP POSITION, $V_{CC} = 3.3V, +25^{\circ}C$

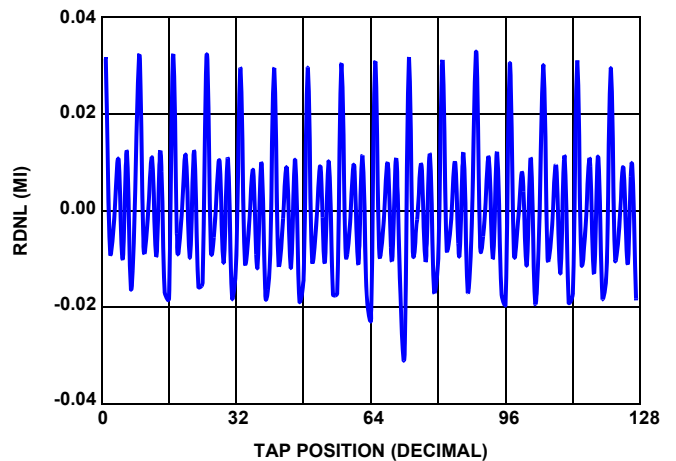

FIGURE 8. 50kΩ RDNL vs TAP POSITION, $V_{CC} = 3.3V, +25^{\circ}C$

Typical Performance Curves (Continued)

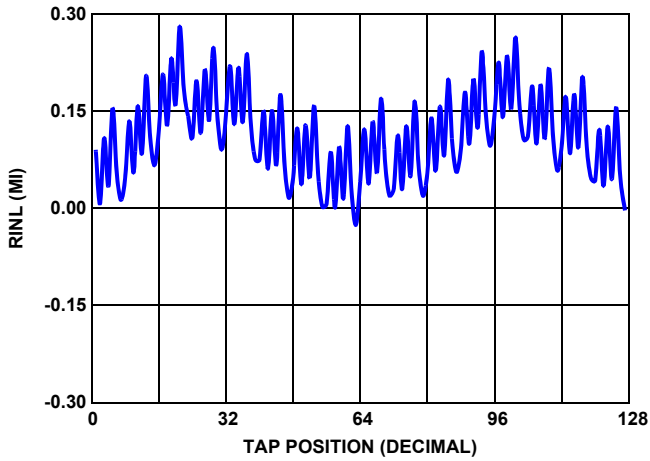

FIGURE 9. 10kΩ RINL vs TAP POSITION, $V_{CC} = 3.3V, +25^{\circ}C$

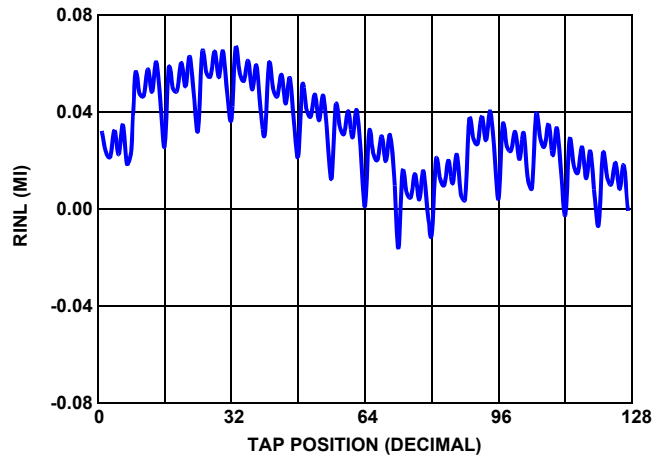

FIGURE 10. 50kΩ RINL vs TAP POSITION, $V_{CC} = 3.3V, +25^{\circ}C$

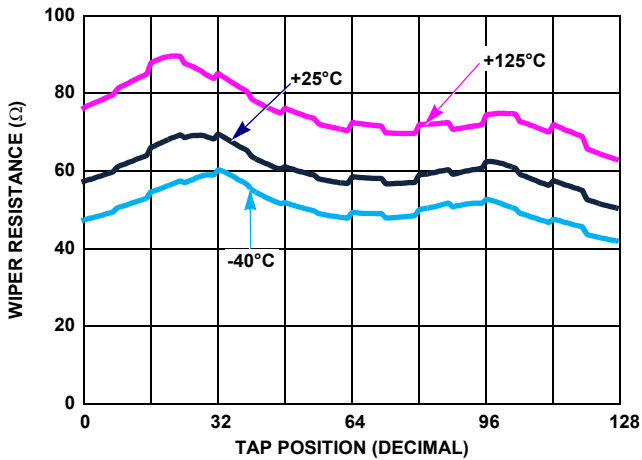

FIGURE 11. 10kΩ WIPER RESISTANCE vs TAP POSITION, $V_{CC} = 3.3V$

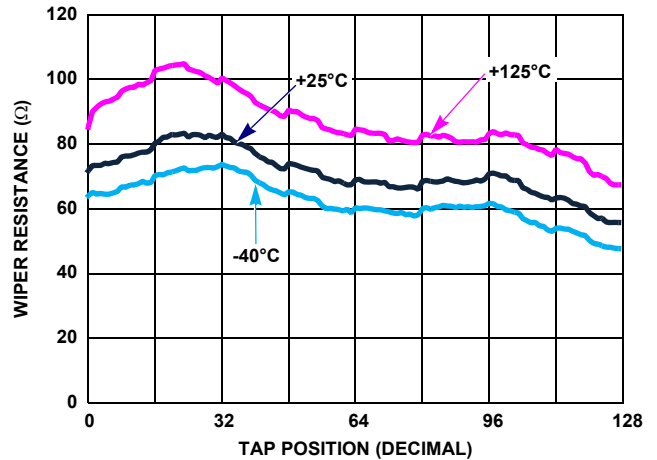

FIGURE 12. 50kΩ WIPER RESISTANCE vs TAP POSITION, $V_{CC} = 3.3V$

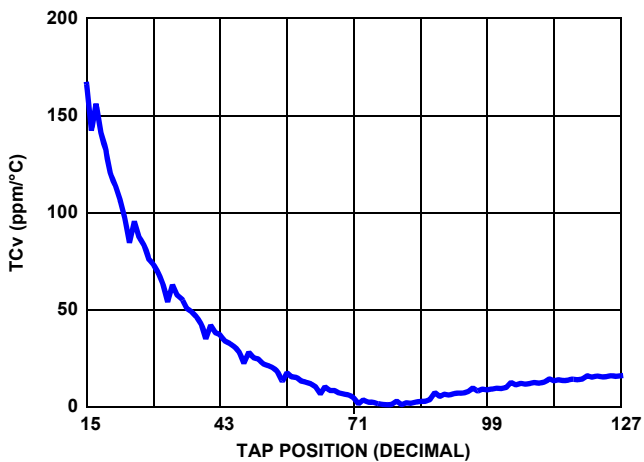

FIGURE 13. 10kΩ TCv vs TAP POSITION, $V_{CC} = 3.3V$

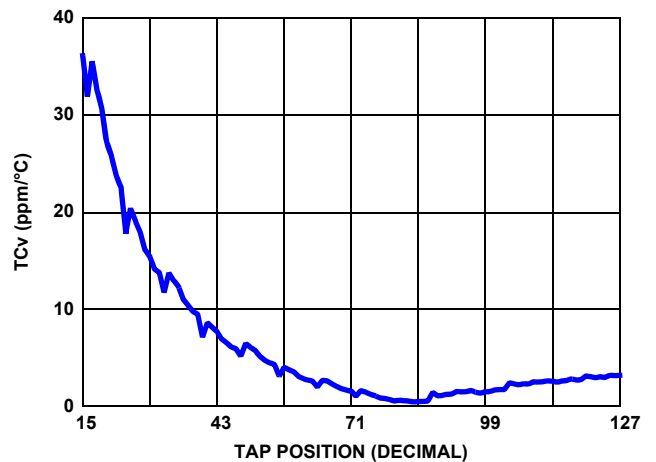

FIGURE 14. 50kΩ TCv vs TAP POSITION, $V_{CC} = 3.3V$

Typical Performance Curves (Continued)

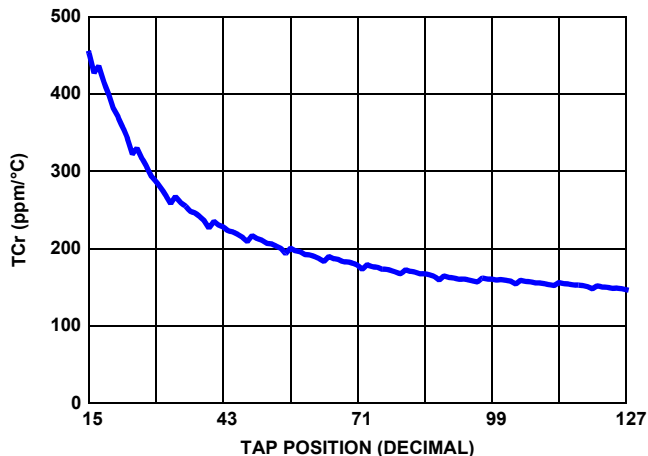

FIGURE 15. 10kΩ TCr vs TAP POSITION

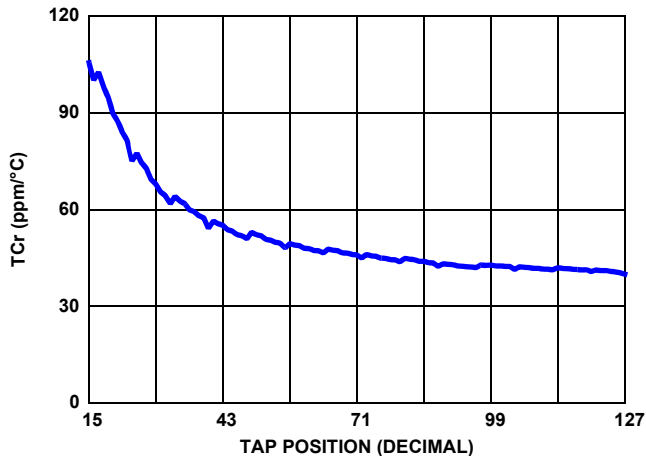

FIGURE 16. 50kΩ TCr vs TAP POSITION, $V_{CC} = 3.3V$

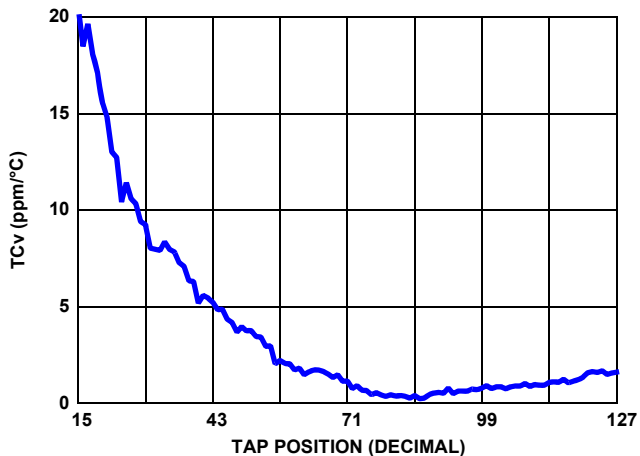

FIGURE 17. 100kΩ TCv vs TAP POSITION, $V_{CC} = 3.3V$

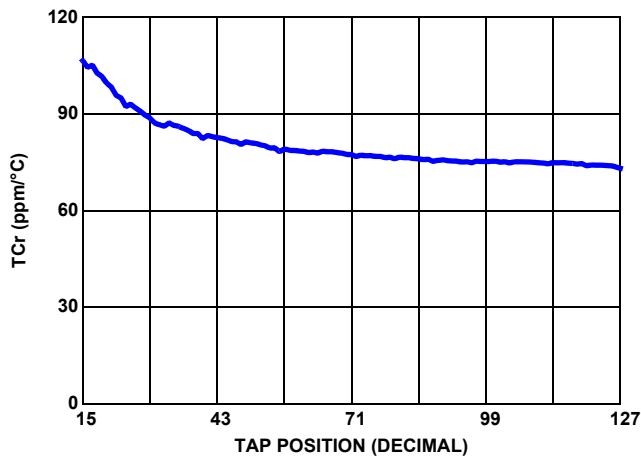

FIGURE 18. 100kΩ TCr vs TAP POSITION, $V_{CC} = 3.3V$

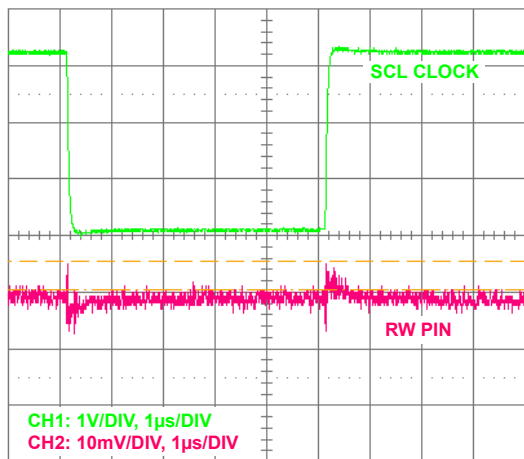

FIGURE 19. WIPER DIGITAL FEED-THROUGH

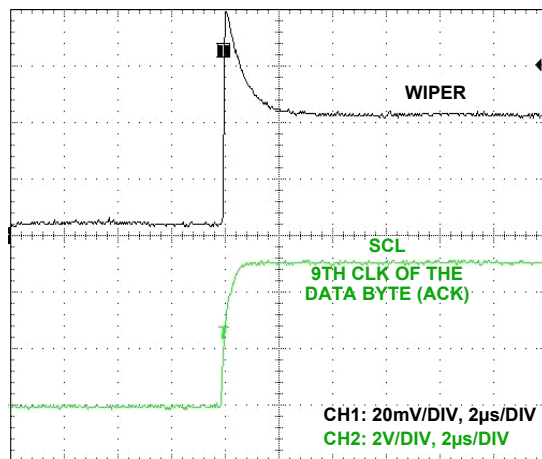

FIGURE 20. WIPER TRANSITION GLITCH

Typical Performance Curves (Continued)

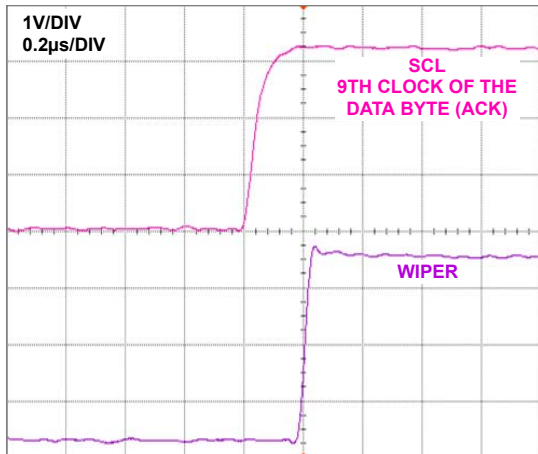

FIGURE 21. WIPER LARGE SIGNAL SETTLING TIME

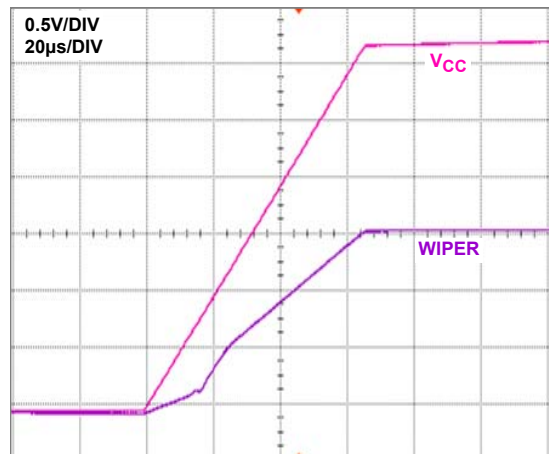

FIGURE 22. POWER-ON START-UP IN VOLTAGE DIVIDER MODE

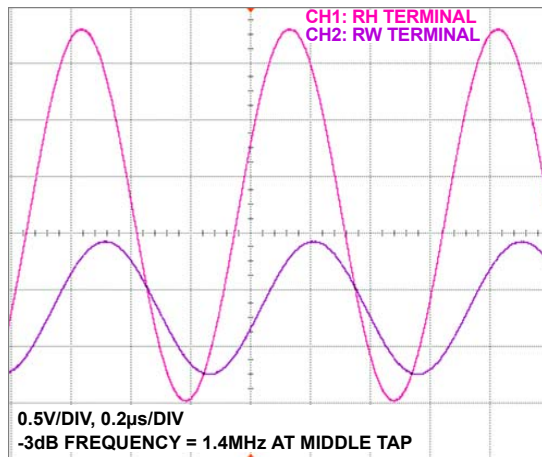

FIGURE 23. 10kΩ -3dB CUT OFF FREQUENCY

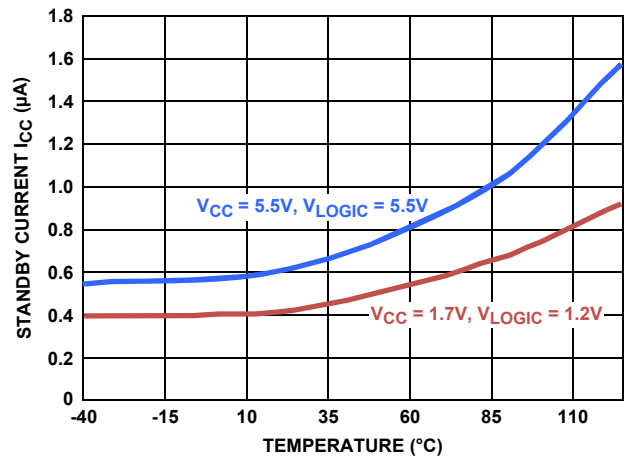

FIGURE 24. STANDBY CURRENT vs TEMPERATURE

Functional Pin Descriptions

Potentiometers Pins

RHi AND RLi

The high (RHi, i = 0, 1) and low (RLi, i = 0, 1) terminals of the ISL23328 are equivalent to the fixed terminals of a mechanical potentiometer. RHi and RLi are referenced to the relative position of the wiper and not the voltage potential on the terminals. With WRi set to 127 decimal, the wiper will be closest to RHi, and with the WR set to 0, the wiper is closest to RLi.

RWi

RWi (i = 0, 1) is the wiper terminal, and it is equivalent to the movable terminal of a mechanical potentiometer. The position of the wiper within the array is determined by the WRi register.

VCC

Power terminal for the potentiometer section analog power source. Can be any value needed to support voltage range of DCP pins, from 1.7V to 5.5V, independent of the VLOGIC voltage.

Bus Interface Pins

SERIAL DATA INPUT/OUTPUT (SDA)

The SDA is a bi-directional serial data input/output pin for I²C interface. It receives device address, wiper address and data from an I²C external master device at the rising edge of the serial clock SCL, and it shifts out data after each falling edge of the serial clock.

SDA requires an external pull-up resistor, since it is an open drain input/output.

SERIAL CLOCK (SCL)

This input is the serial clock of the I²C serial interface. SCL requires an external pull-up resistor, since a master is an open drain output.

DEVICE ADDRESS (A2, A1, A0)

The address inputs are used to set the least significant 3 bits of the 7-bit I²C interface slave address. A match in the slave address serial data stream must match with the Address input pins in order to initiate communication with the ISL23328. A maximum of eight ISL23328 devices may occupy the I²C serial bus (see Table 3).

V_{LOGIC}

Digital power source for the logic control section. It supplies an internal level translator for 1.2V to 5.5V serial bus operation. Use the same supply as the I²C logic source.

Principles of Operation

The ISL23328 is an integrated circuit incorporating two DCPs with its associated registers and an I²C serial interface providing direct communication between a host and the potentiometer. The resistor array is comprised of individual resistors connected in series. At either end of the array and between each resistor is an electronic switch that transfers the potential at that point to the wiper.

The electronic switches on the device operate in a “make-before-break” mode when the wiper changes tap positions.

Voltage at any DCP pins, RHi, RLi or RWi, should not exceed V_{CC} level at any conditions during power-up and normal operation.

The V_{LOGIC} pin is the terminal for the logic control digital power source. It should use the same supply as the I²C logic source which allows reliable communication with a wide range of microcontrollers and is independent from the V_{CC} level. This is extremely important in systems where the master supply has lower levels than DCP analog supply.

DCP Description

Each DCP is implemented with a combination of resistor elements and CMOS switches. The physical ends of each DCP are equivalent to the fixed terminals of a mechanical potentiometer (RHi and RLi pins). The RWi pin of the DCP is connected to intermediate nodes, and is equivalent to the wiper terminal of a mechanical potentiometer. The position of the wiper terminal within the DCP is controlled by an 8-bit volatile Wiper Register (WRi). When the WRi of a DCP contains all zeroes (WRi[7:0] = 00h), its wiper terminal (RWi) is closest to its “Low” terminal (RLi). When the WRi register of a DCP contains all ones (WRi[7:0] = 7Fh), its wiper terminal (RWi) is closest to its “High” terminal (RHi). As the value of the WRi increases from all zeroes (0) to all ones (127 decimal), the wiper moves monotonically from the position closest to RLi to the position closest to RHi. At the same time, the resistance between RWi and RLi increases monotonically, while the resistance between RHi and RWi decreases monotonically.

While the ISL23328 is being powered up, both WR0 and WR1 are reset to 40h (64 decimal), which positions RWi at the center between RLi and RHi.

The WRi can be read or written to directly using the I²C serial interface as described in the following sections.

Memory Description

The ISL23328 contains three volatile 8-bit registers: Wiper Register WR0, Wiper Register WR1, and Access Control Register (ACR). Memory map of the ISL23328 is shown in Table 1. The Wiper Register WR0 at address 0, contains current wiper position of DCP0; The Wiper Register WR1 at address 1 contains current wiper position of DCP1. The Access Control Register (ACR) at address 10h contains information and control bits described in Table 2.

TABLE 1. MEMORY MAP

| ADDRESS (hex) | VOLATILE REGISTER NAME | DEFAULT SETTING (hex) |
|---------------|------------------------|-----------------------|
| 10 | ACR | 40 |
| 1 | WR1 | 40 |
| 0 | WR0 | 40 |

TABLE 2. ACCESS CONTROL REGISTER (ACR)

| BIT # | 7 | 6 | 5 | 4 | 3 | 2 | 1 | 0 |
|------------|---|------|---|---|---|---|---|---|
| NAME/VALUE | 0 | SHDN | 0 | 0 | 0 | 0 | 0 | 0 |

Shutdown Function

The SHDN bit (ACR[6]) disables or enables shutdown mode for all DCP channels simultaneously. When this bit is 0, i.e., DCP is forced to end-to-end open circuit and RW is connected to RL through a 2kΩ serial resistor as shown in Figure 25. Default value of the SHDN bit is 1.

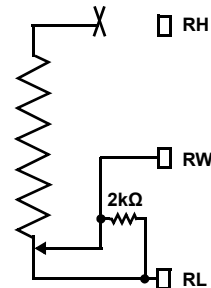

FIGURE 25. DCP CONNECTION IN SHUTDOWN MODE

When the device enters shutdown, all current DCP WR settings are maintained. When the device exits shutdown, the wipers will return to the previous WR settings after a short settling time (see Figure 26).

In shutdown mode, if there is a glitch on the power supply which causes it to drop below 1.3V for more than 0.2 to 0.4μs, the wipers will be RESET to their mid position. This is done to avoid an undefined state at the wiper outputs.

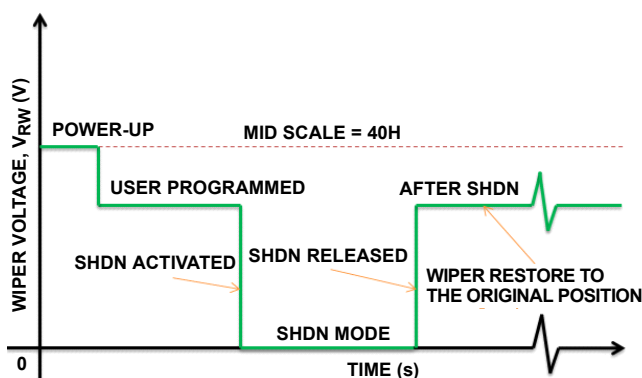

FIGURE 26. SHUTDOWN MODE WIPER RESPONSE

I²C Serial Interface

The ISL23328 supports an I²C bidirectional bus oriented protocol. The protocol defines any device that sends data onto the bus as a transmitter and the receiving device as the receiver. The device controlling the transfer is a master and the device being controlled is the slave. The master always initiates data transfers and provides the clock for both transmit and receive operations. Therefore, the ISL23328 operates as a slave device in all applications.

All communication over the I²C interface is conducted by sending the MSB of each byte of data first.

Protocol Conventions

Data states on the SDA line must change only during SCL LOW periods. SDA state changes during SCL HIGH are reserved for indicating START and STOP conditions (see Figure 27). On power-up of the ISL23328, the SDA pin is in the input mode.

All I²C interface operations must begin with a START condition, which is a HIGH-to-LOW transition of SDA while SCL is HIGH. The

ISL23328 continuously monitors the SDA and SCL lines for the START condition and does not respond to any command until this condition is met (see Figure 27). A START condition is ignored during the power-up of the device.

All I²C interface operations must be terminated by a STOP condition, which is a LOW to HIGH transition of SDA while SCL is HIGH (see Figure 27). A STOP condition at the end of a read operation or at the end of a write operation places the device in its standby mode.

An ACK (Acknowledge) is a software convention used to indicate a successful data transfer. The transmitting device, either master or slave, releases the SDA bus after transmitting eight bits. During the ninth clock cycle, the receiver pulls the SDA line LOW to acknowledge the reception of the eight bits of data (see Figure 28).

The ISL23328 responds with an ACK after recognition of a START condition followed by a valid Identification Byte, and once again after successful receipt of an Address Byte. The ISL23328 also responds with an ACK after receiving a Data Byte of a write operation. The master must respond with an ACK after receiving a Data Byte of a read operation.

A valid Identification Byte contains 1010 as the four MSBs, and the following three bits are matching the logic values present at pins A2, A1 and A0. The LSB is the Read/Write bit. Its value is "1" for a Read operation and "0" for a Write operation (see Table 3).

TABLE 3. IDENTIFICATION BYTE FORMAT
LOGIC VALUES AT PINS A2, A1 AND A0 RESPECTIVELY

| | | | | | | | |
|-------|---|---|---|-------|----|----|--------------|
| 1 | 0 | 1 | 0 | A2 | A1 | A0 | R/ \bar{W} |
| (MSB) | | | | (LSB) | | | |

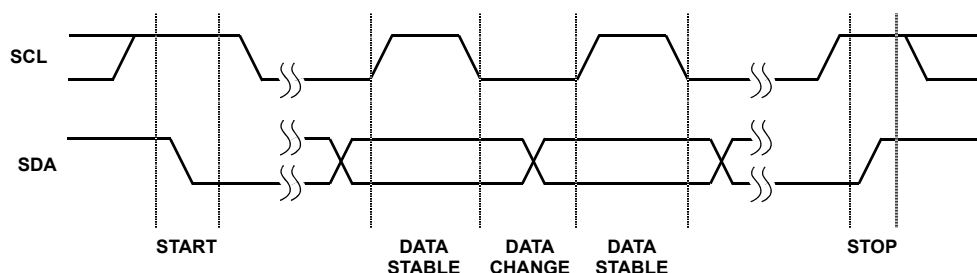

FIGURE 27. VALID DATA CHANGES, START AND STOP CONDITIONS

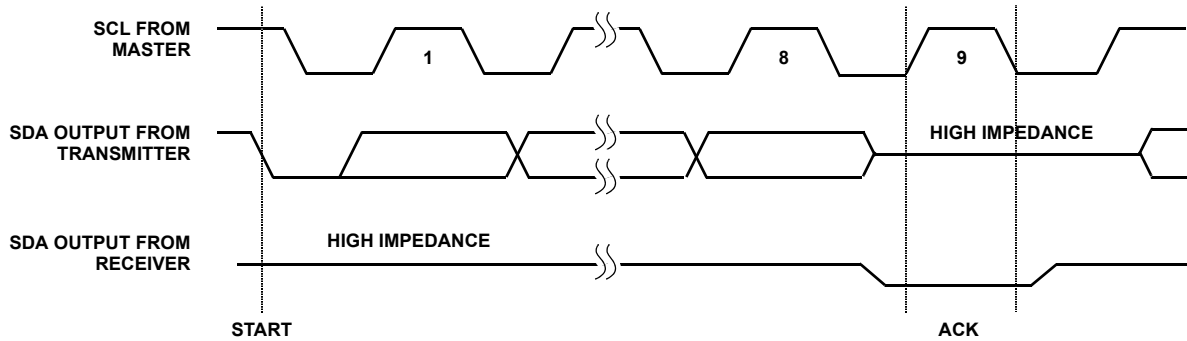

FIGURE 28. ACKNOWLEDGE RESPONSE FROM RECEIVER

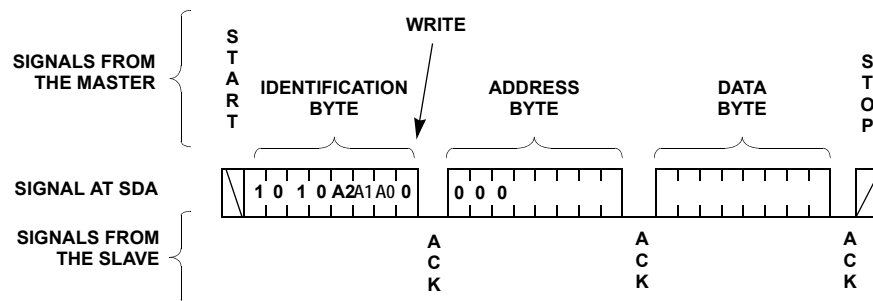

FIGURE 29. BYTE WRITE SEQUENCE

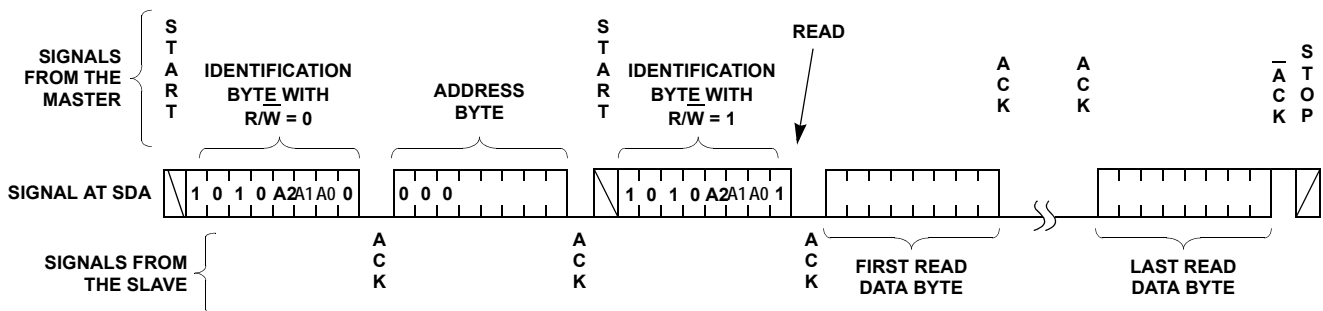

FIGURE 30. READ SEQUENCE

Write Operation

A Write operation requires a START condition, followed by a valid Identification Byte, a valid Address Byte, a Data Byte, and a STOP condition. After each of the three bytes, the ISL23328 responds with an ACK. The data is transferred from I²C block to the corresponding register at the 9th clock of the data byte and the device enters its standby state (see Figures 28 and 29).

It is possible to perform a sequential Write to all DCP channels via a single Write operation. The command is initiated by sending an additional Data Byte after the first Data byte instead of sending a STOP condition.

Read Operation

A Read operation consists of a three byte instruction followed by one or more Data Bytes (see Figure 30). The master initiates the operation issuing the following sequence: a START, the Identification byte with the R/W bit set to "0", an Address Byte, a second START, and a second Identification byte with the R/W bit set to "1". After each of the three bytes, the ISL23328 responds with an ACK; then the ISL23328 transmits Data Byte. The master terminates the read operation issuing a NACK ($\overline{\text{ACK}}$) and a STOP condition following the last bit of the last Data Byte (see Figure 30).

Applications Information

V_{LOGIC} Requirements

V_{LOGIC} should be powered continuously during normal operation. In a case where turning V_{LOGIC} OFF is necessary, it is recommended to ground the V_{LOGIC} pin of the ISL23328. Grounding the V_{LOGIC} pin or both V_{LOGIC} and V_{CC} does not affect other devices on the same bus. It is good practice to put a 1 μ F cap in parallel to 0.1 μ F as close to the V_{LOGIC} pin as possible.

V_{CC} Requirements and Placement

It is recommended to put a 1 μ F capacitor in parallel with 0.1 μ F decoupling capacitor close to the V_{CC} pin.

Wiper Transition

When stepping up through each tap in voltage divider mode, some tap transition points can result in noticeable voltage transients, or overshoot/undershoot, resulting from the sudden transition from a very low impedance “make” to a much higher impedance “break” within a short period of time (<1 μ s). There are several code transitions such as 0Fh to 10h, 1Fh to 20h,..., 6Fh to 7Fh, which have higher transient glitch. Note, that all switching transients will settle well within the settling time as stated in the datasheet. A small capacitor can be added externally to reduce the amplitude of these voltage transients. However, that will also reduce the useful bandwidth of the circuit, thus may not be a good solution for some applications. It may be a good idea, in that case, to use fast amplifiers in a signal chain for fast recovery.

Revision History

The revision history provided is for informational purposes only and is believed to be accurate, but not warranted. Please go to web to make sure you have the latest Rev.

| DATE | REVISION | CHANGE |
|---------|----------|------------------|
| 8/19/11 | FN7902.0 | Initial Release. |

Products

Intersil Corporation is a leader in the design and manufacture of high-performance analog semiconductors. The Company's products address some of the industry's fastest growing markets, such as, flat panel displays, cell phones, handheld products, and notebooks. Intersil's product families address power management and analog signal processing functions. Go to www.intersil.com/products for a complete list of Intersil product families.

*For a complete listing of Applications, Related Documentation and Related Parts, please see the respective device information page on intersil.com: [ISL23328](http://www.intersil.com/ISL23328)

To report errors or suggestions for this datasheet, please go to www.intersil.com/askourstaff

FITs are available from our website at <http://rel.intersil.com/reports/search.php>

For additional products, see www.intersil.com/product_tree

Intersil products are manufactured, assembled and tested utilizing ISO9000 quality systems as noted in the quality certifications found at www.intersil.com/design/quality

Intersil products are sold by description only. Intersil Corporation reserves the right to make changes in circuit design, software and/or specifications at any time without notice. Accordingly, the reader is cautioned to verify that data sheets are current before placing orders. Information furnished by Intersil is believed to be accurate and reliable. However, no responsibility is assumed by Intersil or its subsidiaries for its use; nor for any infringements of patents or other rights of third parties which may result from its use. No license is granted by implication or otherwise under any patent or patent rights of Intersil or its subsidiaries.

For information regarding Intersil Corporation and its products, see www.intersil.com

Package Outline Drawing

M14.173

14 LEAD THIN SHRINK SMALL OUTLINE PACKAGE (TSSOP)

Rev 3, 10/09

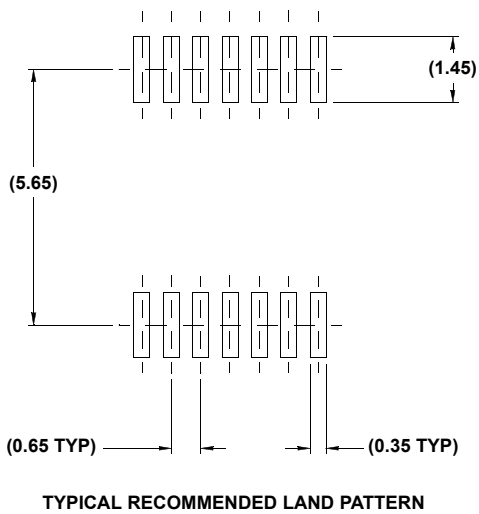
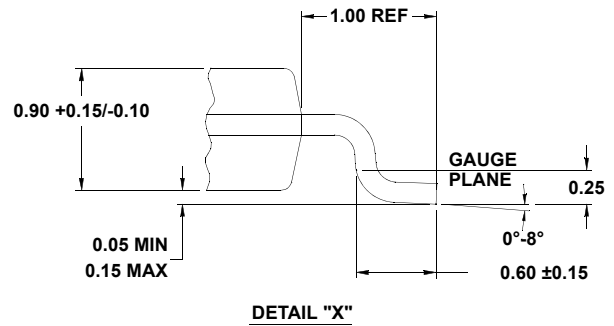
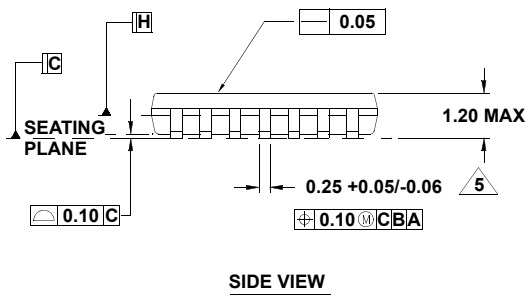
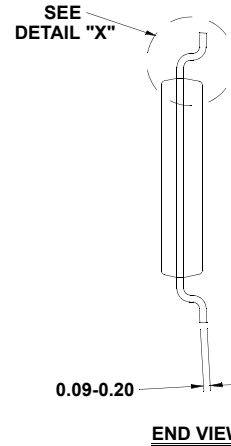
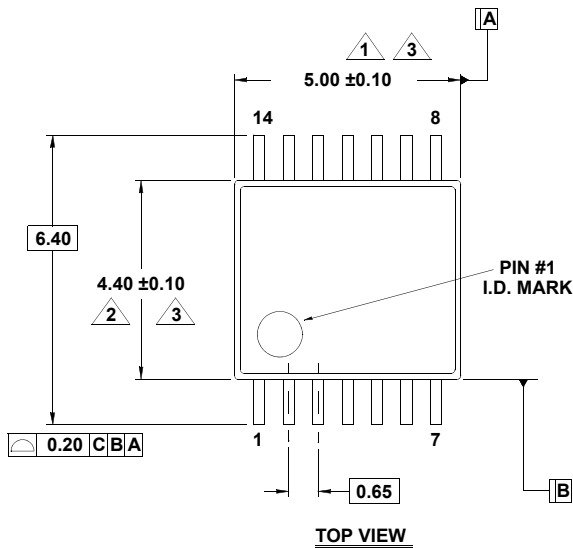

NOTES:

1. Dimension does not include mold flash, protrusions or gate burrs. Mold flash, protrusions or gate burrs shall not exceed 0.15 per side.
2. Dimension does not include interlead flash or protrusion. Interlead flash or protrusion shall not exceed 0.25 per side.
3. Dimensions are measured at datum plane H.
4. Dimensioning and tolerancing per ASME Y14.5M-1994.
5. Dimension does not include dambar protrusion. Allowable protrusion shall be 0.80mm total in excess of dimension at maximum material condition. Minimum space between protrusion and adjacent lead is 0.07mm.
6. Dimension in () are for reference only.
7. Conforms to JEDEC MO-153, variation AB-1.

Ultra Thin Quad Flat No-Lead Plastic Package (UTQFN)

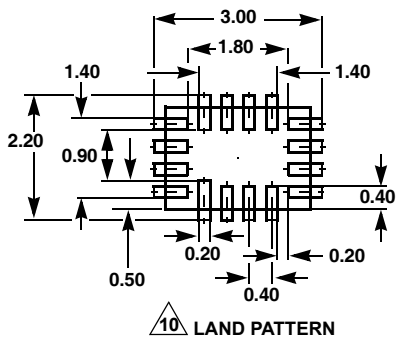
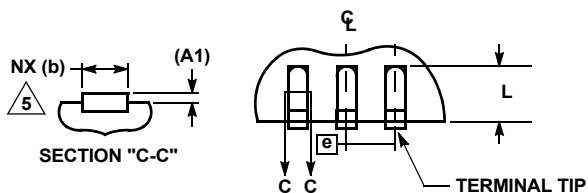
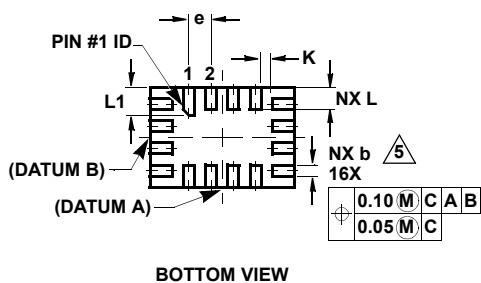
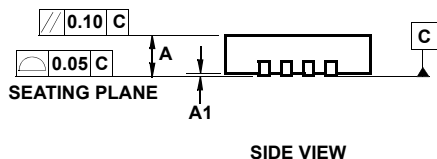
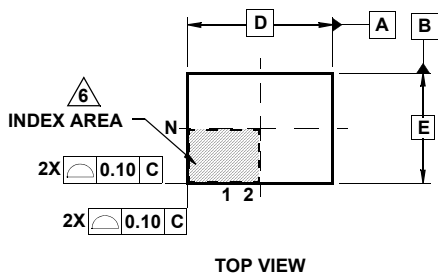

L16.2.6x1.8A

16 LEAD ULTRA THIN QUAD FLAT NO-LEAD PLASTIC PACKAGE

| SYMBOL | MILLIMETERS | | | NOTES |
|--------|-------------|---------|------|-------|
| | MIN | NOMINAL | MAX | |
| A | 0.45 | 0.50 | 0.55 | - |
| A1 | - | - | 0.05 | - |
| A3 | 0.127 REF | | | - |
| b | 0.15 | 0.20 | 0.25 | 5 |
| D | 2.55 | 2.60 | 2.65 | - |
| E | 1.75 | 1.80 | 1.85 | - |
| e | 0.40 BSC | | | - |
| K | 0.15 | - | - | - |
| L | 0.35 | 0.40 | 0.45 | - |
| L1 | 0.45 | 0.50 | 0.55 | - |
| N | 16 | | | 2 |
| Nd | 4 | | | 3 |
| Ne | 4 | | | 3 |
| θ | 0 | - | 12 | 4 |

Rev. 5 2/09

NOTES:

1. Dimensioning and tolerancing conform to ASME Y14.5-1994.
2. N is the number of terminals.
3. Nd and Ne refer to the number of terminals on D and E side, respectively.
4. All dimensions are in millimeters. Angles are in degrees.
5. Dimension b applies to the metallized terminal and is measured between 0.15mm and 0.30mm from the terminal tip.
6. The configuration of the pin #1 identifier is optional, but must be located within the zone indicated. The pin #1 identifier may be either a mold or mark feature.
7. Maximum package warpage is 0.05mm.
8. Maximum allowable burrs is 0.076mm in all directions.
9. JEDEC Reference MO-255.
10. For additional information, to assist with the PCB Land Pattern Design effort, see Intersil Technical Brief TB389.