

Amphenol® Low Mating Force Rectangular Connectors

12-035-10



Amphenol

Table of Contents

Page No.	Item
1	The B ³ Contact Innovation
2, 3	Low Mating Force Electrical Connectors
4	Low Mating Force Hybrid Configurations
5 – 8	How to Order
8, 9	Contact Arrangements
10, 11	Contact Repair/Replacement, Installation Instructions
12 – 15	Mother Board Connector
16 – 19	Daughter Board Connector
20 – 23	Input/Output Connector
24 – 27	PC Connector
28	Accessories, Polarization Keys
29	Accessories, Mounting Applications
30	Accessories, Test Probe Kit
31	LRM Surface Mount Connectors

Due to space limitations, metric equivalents of dimensional data in this catalog have not been included. All dimensions given may be converted to the metric system by the standard formula: inches x 25.40 = Millimeters.

If more information is needed concerning the products in this publication, or if you have any special application needs, please contact your nearest Amphenol sales office or Amphenol Corporation at the following address:

Amphenol Corporation
Amphenol Aerospace
40-60 Delaware Ave.
Sidney, NY 13838-1395
Telephone: 607-563-5011
Fax: 607-563-5157
www.amphenol-aerospace.com

NOTE: The connector products in this brochure were formerly known as Bendix® products. These products are now manufactured and sold under the Amphenol® brand name. The name "Amphenol" will replace the name "Bendix" on products and literature in the future.

Amphenol Aerospace is a Certified ISO 9001 Manufacturer.



the B³ Contact Innovation . . .

The Amphenol® B³ Contact is an engineered, innovative solution to problems caused by the high mating and unmating forces of conventional pin and socket contact pairs. B³ stands for Bristle Brush Bunch, a descriptive name for the multiple strands of high tensile strength wire that are bundled together to form the brush-like contact. By intermeshing two multi-strand wire bundles, an electrical connection is made. The B³ contact design results in low, normal contact site forces and significantly reduces mating and unmating forces.

The B³ Contact offers:

- low mating/unmating forces
- superior electrical characteristics
- proven durability and long contact life
- a new age of PC design

Applications for Amphenol Connectors with Brush B³ contacts:

- Medical equipment
- IC chip testers
- Telecommunications
- Military and commercial aviation
- Military ground vehicles
- GPS systems
- Space
- Industrial

Amphenol[®] Low Mating Force Rectangular Connectors MIL-C-55302 (M55302/166 thru /172)



Featuring the Amphenol[®] B³ Bristle[®] Brush[®] Contact

- **Low Mating and Unmating Forces**
 - Smooth, low friction interfaces
 - 70% to 90% reduction in mating/unmating forces from conventional pin-socket contacts
 - 1.5 oz. maximum forces per contact pair (one ounce typical)
 - Easy mating/unmating makes high circuit counts practical (25 lbs. typical for 400 contacts)
 - Mechanical mating aids not required
 - No need for external board support structures for connectors up to 7 inches in length. A center support is recommended for Mother Board Connectors over 7 inches
- **Proven durability and long contact life**
 - Over 20,000 cycles of mating and unmating without performance degradation
 - Documented intermittency-free performance – no 10 nano second discontinuities during 50m cycles of 0.010 displacement
 - Overall cost effectiveness (reduced life cycle costs)
- **Multiple points of contact = superior electrical capability**
 - 14-70 points of contact per mated contact
 - Stable, low resistance – 20 milliohms max.
 - Redundant current paths - lower total resistance
 - Proven electrical and gas tight contact sites
- **Key Connector Features**
 - 0.100 inch center to center, square grid contact spacing
 - Four body styles - Mother Board, Daughter Board, PC (also referred to as "right angle Motherboard"), and Input/Output - allows application flexibility (parallel boards, perpendicular boards, wire to board, end to end boards, card extenders)
 - 2, 3 and 4 row contact arrangements with 10 to 100 contacts per row in one contact per row increments
 - Termination versatility: straight & 90° PCB stud, wire wrap and crimp
 - Options on termination length and plating
 - Front release/front removable contacts in Mother Board, Daughter Board and PC versions; rear release/rear removable crimp contacts (size 22D) or printed circuit board pins provided with Input/Output Connector
 - Accessories available for latching and polarization
 - Up to 256 keyed, mating polarizations available
 - Hybrids available – mix signal with power, RF or fiber optics

- **Performance**

- voltage rating: $\frac{SL}{1300} \frac{70,000 \text{ ft.}}{325}$
- one and one-half ounce max. average contact engaging/separating forces
- 7 milliohm average contact resistance for row A contacts (Resistance will vary depending on the point of measurement and the length of the contact.)
- 3 ampere – PCB contacts
- 5 ampere – wire wrap/crimp contacts
- –65° C to +125° C temperature rating
- 5 gigaohms minimum insulation resistance

- **Materials**

- Connector Body – Glass-filled thermoplastic molding material in accordance with MIL-M-24519 type GPT-15F and/or Grade B, Class 15 of MIL-P-46161 (UL94V-O).
- Polarization Keys – Glass-filled acetal plastic molding material in accordance with MIL-P-46137
- Locking Screw/Mounting Bushing – Corrosion resistant steel AISI 300 types passivated in accordance with QQ-P-35

- **Contacts**

- Holders – Copper alloy in accordance with Federal Specification QQ-B-626 or SAE J463
- Wire – Beryllium copper in accordance with Federal Specification ASTM B197
- Sleeves – If applicable, stainless steel in accordance with AMS-5514 passivated in accordance with ASTM A967

Upper Right: An Input/Output and Mother Board Connector

Lower Left: Unmated Input/Output and PC Connector

Lower Right: Mated Mother Board and Daughter Board Connector

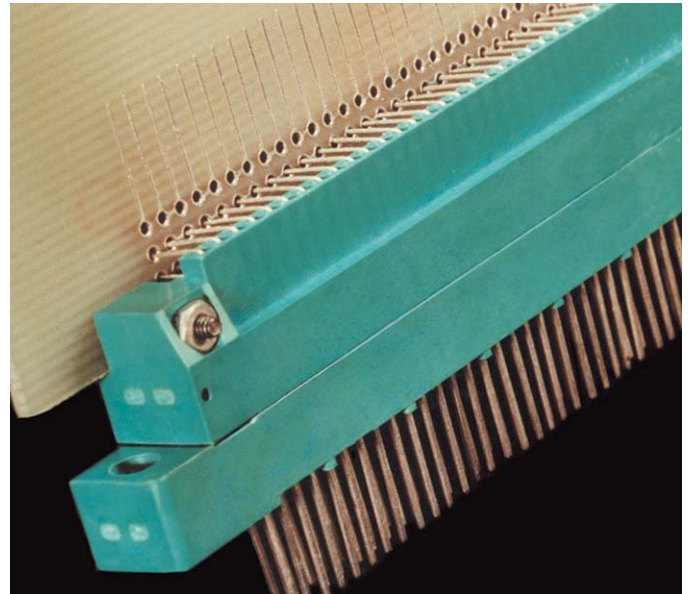
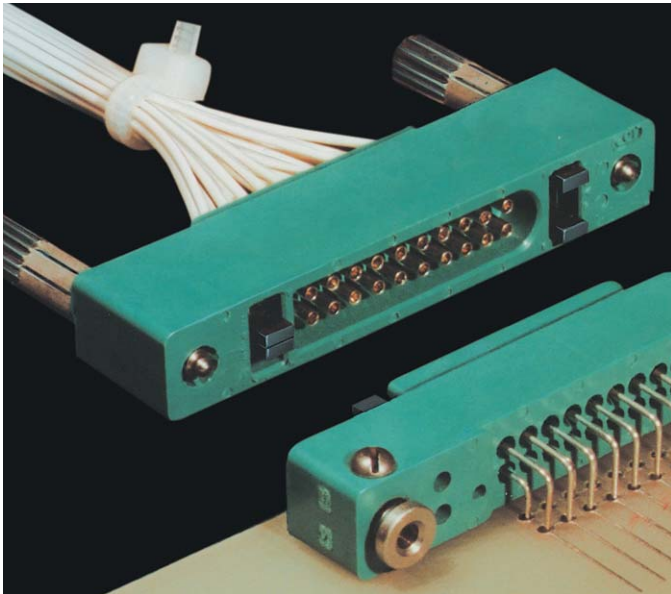
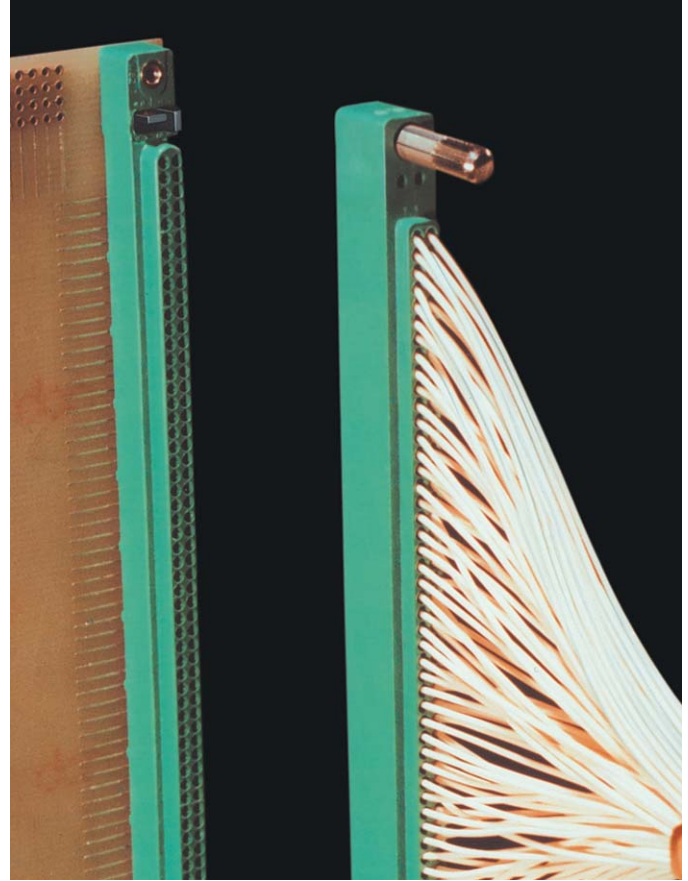

Low Mating Force hybrid configurations – signal, power, coax or fiber optics

Power and/or shielded (coax or twinax) contacts are available in combination with Brush signal contacts in one high density (hybrid) connector.

- Available with 100 brush signal contacts with up to 12 size 16 power or coax contacts in a 2 row connector
- Available with 180 brush signal contacts with up to 12 size 12 power or coax contacts in a 3 row connector
- Use of standard MIL-DTL-38999*, Series II power and coax contacts

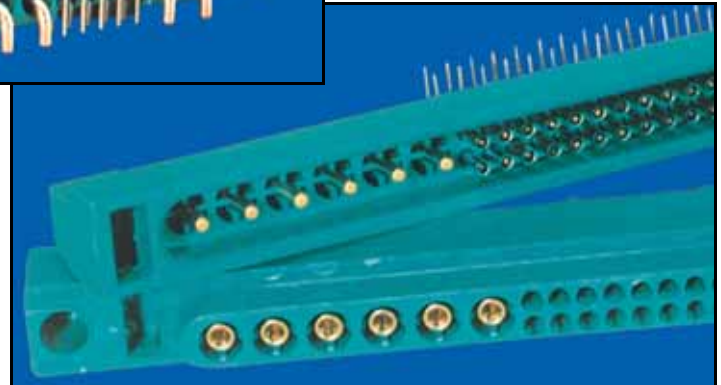

COMBINATION OF BRUSH CONTACTS
AND POWER CONTACTS

Hybrid configurations can be made available with fiber optics and Brush contacts in the same connector.

Amphenol's superiority and breadth of product offering is demonstrated in its capability for packaging fiber termini and the Brush contact in a printed circuit board rectangular connector. Optical performance, high speed and secure communication are obtained with fiber optic interconnects incorporated into the rectangular housings, along with the low mating force advantages of the brush contact in the same connector.

NOTE: Power and coax contacts and fiber optic termini are not provided with the connector and must be purchased separately.

Consult Amphenol Aerospace, Sidney, NY for assistance in solving design problems and for part numbers that will provide the proper combination of these hybrid configurations to meet your specific connector application requirements.

* MIL-DTL-38999 supersedes MIL-C-38999.



COMBINATION OF BRUSH CONTACTS
AND SHIELDED CONTACTS

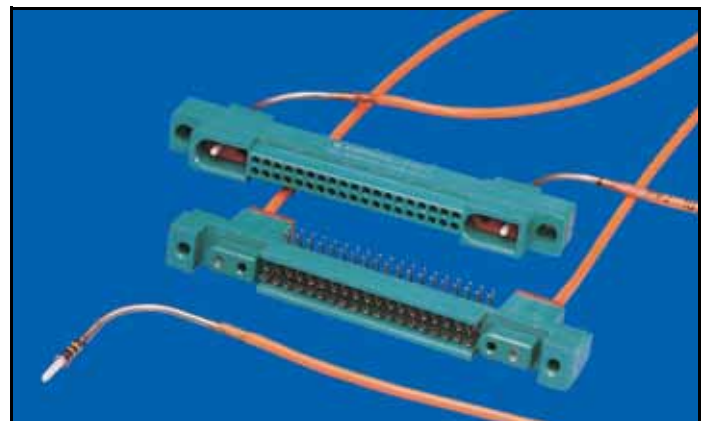

COMBINATION OF BRUSH CONTACTS AND FIBER OPTIC TERMINI

Low Mating Force

how to order (military types)

MB, DB, PC Connectors Military Part Number Ordering Procedure

Example part number M55302/166A10X1 is shown as follows:



Body Type/Contact Style

- /166 designates MB-P (Mother Board, Printed Circuit Board Termination)
- /167 designates MB-W (Mother Board, Wire-wrap Contacts)
- /168 designates PC (Printed Circuit, 90° Printed Circuit Board Termination)
- /170 designates DB (Daughter Board, 90° Printed Circuit Board Termination)

Number of Rows

- A – 2 Rows
- B – 3 Rows
- C – 4 Rows

Number of Contacts per Row

Contact counts per row range from 10 to 100
(Only 2 digits permitted in this space; for 100 contacts per row, use 00)

Tail Length

MB-P (PCB Termination)*	MB-W** (Wire-wrap)
X – .300 ±.025	Y – .700 ±.025
Y – .145 ±.025	Z – .542 ±.025
Z – .113 ±.025	

DB*	PC*
X – .300 ±.025	Y – .150 +.035 –.025
Y – .150 ±.025	Z – .095 +.035 –.025
Z – .120 ±.025	

* Reference "J" Dimension on all connector drawings in this catalog.
** For MB-W only: Reference "H" Dimension on connector drawing on page 12.

Tail Finish

- Tin lead per MIL-P-81728, 50 to 70% tin, .0001 min. thick over copper
- Gold per MIL-G-45204, type II, grade C, class 00 (01 for MB-W) over nickel per QQ-N-290

IO Connectors Military Part Number Ordering Procedure

Example part number M55302/169A101 is shown as follows:



Body Type

- /169 designates IO (Input/Output)
(Contact type/finish is last digit of IO part number - see list of options below)

Number of Rows

- A – 2 Rows
- B – 3 Rows
- C – 4 Rows

Number of Contacts per Row

Contact counts per row range from 10 to 100
(Only 2 digits permitted in this space; for 100 contacts per row, use 00)

Contact Type/Finish

- Crimp contact – Tin lead per MIL-P-81728, 50 to 70% tin, .0001 min. thick over copper
- Crimp contact – Gold per MIL-G-45204, type II, grade C, class 1 over copper
- Connectors supplied less contacts
- PCB contacts installed with .145 ±.025 stickout – Tin lead per MIL-P-81728, 50 to 70% tin, .0001 min. thick over copper (Reference "J" Dimension on connector drawing on page 20).

To Order IO Contacts

(For use with connectors less contacts)

M55302/171-1

_____ suffix designates crimp well finish

Crimp well finish

- Crimp contact – Tin lead per MIL-P-81728, 50 to 70% tin, .0001 min. thick over copper
- Crimp contact – Gold per MIL-G-45204, type II, grade C class 1 over copper

To order Accessories, see page 7.

Low Mating Force

how to order (proprietary types)

MB, DB, IO, PC Connectors

Proprietary Part Number Ordering Procedure

Example part number MB2-120P- () is shown as follows:



Body Type

MB designates Mother Board
 DB designates Daughter Board
 IO designates Input/Output
 PC designates Printed Circuit

Number of Rows

2, 3 or 4 rows

Total Number of Contacts

See Contact Arrangements, pages 8 and 9

Standard Termination Style

(Stickout values below apply to "J" dimension referenced on individual connector catalog pages.)

MBX-XXXP	Straight PCB stud, .021 dia, .113 ±.025 stickout, Sn/Ni plate
MBX-XXXW	Solderless wrap, .025 sq., .507 ±.025 stickout, Sn/Ni plate
DBX-XXXP	90° PCB stud, .021 dia, .085 ±.025 stickout, Sn/Ni plate
IOX-XXXX	Crimp, rear removable contact, size 22D wire well, Sn/Ni plate
IOX-XXXP	PCB stud, .021 dia, .145 ±.025 stickout, Sn/Ni plate
PCX-XXXP	90° PCB stud, .021 dia, .095 ⁺⁰³⁵ / _{-.025} stickout, Sn/Ni plate

LEGEND:

Sn/Ni designates Tin over Nickel
 Au/Ni designates Gold over Nickel
 Au/Cu designates Gold over Copper
 SnPb/Cu designates Tin-Lead over Copper

Variation Suffix

(Stickout values below apply to "J" dimension referenced on individual connector catalog pages.)

(700)	Gold plate in accordance with MIL-G-45204, type II, .000030 min. thick gold (.000050 for solderless wrap) over .000050 min. thick nickel (standard termination length)
(701)	Gold plate in accordance with MIL-G-45204, type II, .000050 min. thick gold over .00015 min. thick copper (standard termination length)
(702)	PCB stud stickout of .145, Sn/Ni plate, MB-P
(703)	Au/Ni [same as (700)], PCB stud stickout of .145, MB-P
(704)	Au/Cu [same as (701)], PCB stud stickout of .145, MB-P
(705)	90° PCB stud, .120 stickout, Sn/Ni plate, DB
(706)	Au/Ni [same as (700)], 90° PCB stud .120 stickout, DB
(707)	Au/Cu [same as (701)], 90° PCB .120 stickout, DB
(709)	PCB stud stickout of .300 DB (90°), .300 MB-P & .335 IO-P, Sn/Ni plate
(710)	Solderless wrap, .025 sq., .665 stickout, Sn/Ni plate, MB-W
(711)	Solderless wrap, .025 sq., .665 stickout, Au/Ni, [same as (700)], MB-W
(713)	PCB stud stickout of .060, Sn/Ni plate, IO-P
(714)	90° PCB stud stickout of .150, Sn/Ni plate, PC & DB
(715)	Solderless wrap, .025 sq., .665 stickout, Au/Cu [same as (701)], MB-W
(716)	90° PCB stud stickout of .085 matte tin, DB
(717)	90° PCB stud stickout of .095 matte tin, PC
(718)	90° PCB stud stickout of .120 matte tin, DB
(719)	PCB stud stickout of .300 MB-P & .335 IO-P, matte tin
(720)	PCB stud stickout of .060 matte tin, IO-P
(721)	PCB stud stickout of .500, Sn/Ni plate, IO-P
(722)	PCB stud stickout of .356 matte tin, MB-P
(723)	PCB stud stickout of .192, Sn/Ni plate, MB-P
(724)	90° PCB stud stickout of .095, RTV potted rear, Sn/Ni plate, PC
(725)	90° PCB stud stickout of .120, RTV potted rear, Sn/Ni plate, DB
(726)	90° PCB stud stickout of .150, RTV potted rear, Sn/Ni plate, PC & DB
(727)	PCB stud stickout of .145, RTV potted rear, Sn/Ni plate, MB-P
(728)	PCB stud stickout of .145, Au/Ni, [same as (700)], RTV potted rear, MB-P
(729)	90° PCB stud stickout of .120, Au/Ni, [same as (700)], RTV potted rear, DB
(730)	90° PCB stud stickout of .150, Au/Ni, [same as (700) above], PC and DB
(731)	PCB stud stickout of .145, matte tin, MB-P

Variation Suffixes continued on next page.

Low Mating Force how to order (proprietary types)/accessories

MB, DB, IO, PC Connectors

Proprietary Part Number Ordering Procedure

Variation Suffix, cont.

(732)	PCB stud stickout of .300 DB (90°), .300 MB-P and .335 IO-P, Au/Cu [same as (701)],
(733)	PCB stud stickout of .421, matte tin, MB-P
(734)	Solderless wrap .025 sq.; .665 stickout, Au/Ni, [same as (700)], RTV potted rear, MB-W
(735)	RTV potted rear, standard termination length, Au/Ni, [same as (700)]
(736)	RTV potted rear, standard termination length, Sn/Ni [use (724) for PC]
(737)	PCB stud stickout of .300 DB (90°), .300 MB-P and .335 IO-P, Au/Ni, [same as (700)], RTV potted rear
(738)	PCB stud stickout of .192 SnPb/Cu (Mil-Spec), MB-P
(739)	PCB stud stickout of .300 DB (90°), .300 MB-P and .335 IO-P; RTV potted rear, Sn/Ni
(740)	Solderless wrap .025 sq.; .665 stickout, Sn/Ni, RTV potted rear, MB-W
(741)	Solderless wrap .025 sq.; .280 stickout, Au/Ni, [same as (700)], MB-W
(742)	PCB .145, Au/Ni, [same as (700)], epoxy potted rear, MB-P
(743)	90° PCB .120, Au/Ni, [same as (700)], epoxy potted rear, DB
(744)	90° PCB .120, Au/Ni, [same as (700)], (MIL-Spec), epoxy potted rear, DB
(746)	90° PCB .120, SnPb/Cu, (MIL-Spec), epoxy potted rear, DB
(747)	PCB stud stickout of .200, Sn/Ni, IO-P
(748)	PCB stud stickout of .145, Sn/Ni, epoxy potted rear, MB-P
(749)	PCB, epoxy potted rear, standard termination length, Sn/Ni

(750)	PCB stud stickout of .172 termination, Au/Ni, [same as (700)], RTV potted rear, MB-P
(751)	90° PCB stud stickout of .150, Sn/Ni, epoxy potted rear, PC
(752)	Au/Ni, epoxy potted rear, standard termination length
(753)	Solderless wrap .025 sq.; .665 stickout, Au/Ni, [same as (700)], epoxy potted rear, MB-W
(754)	PCB stud stickout of .172 termination, SnPb/Cu (MIL-Spec), MB-P
(757)	PCB stud, .391 stickout, matte tin, MB-P
(758)	PCB stud, .172 stickout, Au/Ni, [same as (700)], epoxy potted rear, MB-P
(760)	PCB stud, .192 stickout, Au/Ni (Mil-Spec), MB-P
(761)	90° PCB stud, .120 stickout, Sn/Ni, epoxy potted rear, DB
(762)	PCB stud, .145 stickout, Au/Ni (Mil-Spec), epoxy potted rear, MB-P
(763)	PCB stud, .145 stickout, SnPb/Cu (Mil-Spec), epoxy potted rear, MB-P
(764)	90° PCB stud, .150 stickout, SnPb/Cu (Mil-Spec), epoxy potted rear, DB & PC
(765)	PCB stud, stickout of .300 DB (90°), .300 MB-P, SnPb/Cu (Mil-Spec), epoxy potted rear
(766)	90° PCB stud, .120 stickout, Au/Ni (Mil-Spec), epoxy potted rear, DB
(767)	PCB stud, .192 stickout, Au/Ni (Mil-Spec), epoxy potted rear, MB-P
(768)	PCB stud, .172 stickout, Au/Ni (Mil-Spec), MB-P
(769)	90° PCB stud, .200 stickout, Au/Ni (Mil-Spec), DB
(770)	90° PCB stud, .260 stickout, Au/Ni (Mil-Spec), DB

Accessories

Amphenol® Low Mating Force Connectors are shipped less accessory items.

Accessories may be ordered by either military or proprietary part numbers shown below:

Accessory Item	Series	Military Part Number	Proprietary Part Number	Qty. Required
Polarization Keys	MB, DB, IO, PC	M55302/78-02	10-285422-2	4*
Locking/Mounting Bushing	MB	M55302/172-01	10-411196-3	2
Alternate Length Bushing (Longer)	MB	M55302/172-02	10-411196-5	2
Locking Bushing	PC	M55302/172-05	10-411196-4	2
Locking Screw, Plain	IO	M55302/172-04	10-502599	2
Locking Screw, Slotted	IO	-	10-502599-1	2
Locking Screw, Slotted (Low Profile)	IO	M55302/172-03	10-502599-2	2
Test Probe Kit	MB, DB, IO, PC	-	11-10400-22	1**

See pages 28-30 for more detailed information on these accessory items.

* 4 Keys required per connector half, if used

** One kit per connector gender is recommended

Low Mating Force contact arrangements

Contacts

Contacts are supplied with MB, DB, IO and PC Connector Series assemblies as ordered. Replacement contacts are available; consult Amphenol Aerospace for information.

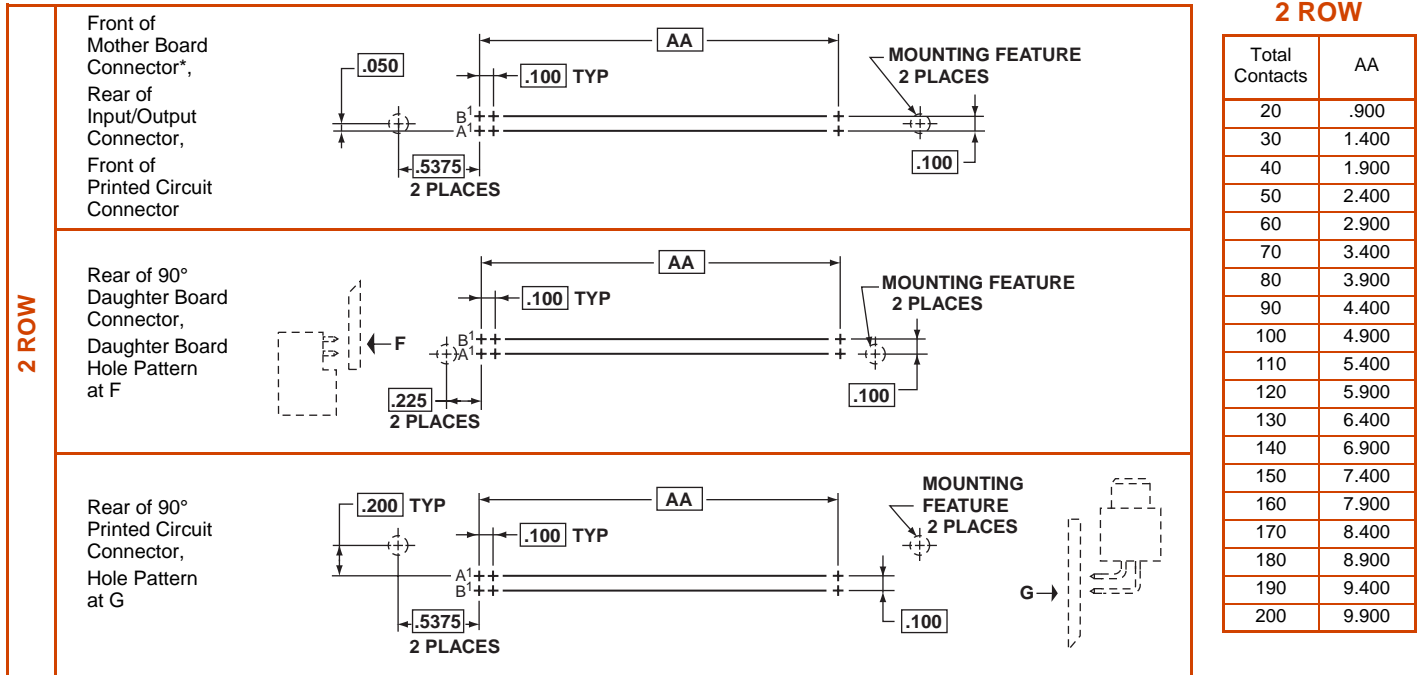

* See contact data table on individual connector drawing pages.

† See page 16 for effective termination length dimensions.

□ Designates Basic Dimension.

Consult Amphenol drawing for solderless wrap contact fixturing (datum) hole locations to facilitate connector alignment.

Low Mating Force contact arrangements, cont.



3 ROW

Total Contacts	AA
30	.900
45	1.400
60	1.900
75	2.400
90	2.900
105	3.400
120	3.900
135	4.400
150	4.900
165	5.400
180	5.900
195	6.400
210	6.900
225	7.400
240	7.900
255	8.400
270	8.900
285	9.400
300	9.900



4 ROW

Total Contacts	AA
40	.900
60	1.400
80	1.900
100	2.400
120	2.900
140	3.400
160	3.900
180	4.400
200	4.900
220	5.400
240	5.900
260	6.400
280	6.900
300	7.400
320	7.900
340	8.400
360	8.900
380	9.400
400	9.900

□ Designates Basic Dimension.
 Consult Amphenol drawing for solderless wrap contact fixturing (datum) hole locations to facilitate connector alignment.

Low Mating Force contact installation instructions, repair/replacement

Individual contacts in the B³ Low Mating Force Connector line can be removed and replaced, thereby avoiding replacement of the entire connector.

TOOLS REQUIRED:

MB, PC Series 11-10368 Tool*
 11-10372 Insertion Tool*
 solder removal equipment

IO Series M22520/2-01 Crimp Tool
 Daniels Tool #K743 Positioner
 10-296943-22 Removal Tool
 10-296940-22 Insertion Tool

CONTACT REMOVAL - DB SERIES

Contact removal is accomplished from the front or mating side of this connector series without removing the entire connector from the printed circuit board. Determine which contact is to be removed from the connector and cut tail. Unsolder cut tail. Solder sucking may be necessary to clear the printed circuit board of solder and cut tail.

Pull the contact through the front side of the connector with tweezers. Care must be taken not to damage adjacent contacts. Discard the damaged contact.

CONTACT REPLACEMENT/INSERTION - DB SERIES

Using tweezers or fingers, carefully place the replacement contact TAIL FIRST into the appropriate contact cavity in the front of the connector. Before final seating of the contact make provisions for proper dressing of the contact, since the 90° tail of the DB connector must be routed through its nest in the connector body molding and, in turn, into the printed circuit board hole.

Push the contact into the cavity with a flat-edged rod of .060 to .100 inch diameter until contact seats. Do not push against bristle wires or bend shroud. It may be necessary to simultaneously bend the contact tail during this step. Dress and resolder contact tail in proper location.

CONTACT REMOVAL - MB, PC SERIES**

Contact removal is accomplished from the front or mating side of these connector series without removing the entire connector from the printed circuit board. Determine which contact is to be removed from the connector and unsolder or unwrap the contact tail as applicable. Tail cutting and/or solder sucking may be necessary to clear the printed circuit board.

Inspect the damaged contact to determine if the bristle wires are bent in a particular direction within the contact cavity. The slot in the tube end of the 11-10368 Extraction Tool is designed to accommodate these bent strands.

Retract the plunger of the 11-10368 Extraction Tool to its furthest point of travel, and line up the slot in the tube end with any bent bristle wires in the contact cavity. Insert the tool into contact cavity. A moderate amount of resistance will be encountered until the contact retention tines are deflected, and then a positive stop will be felt.

* Available from Amphenol Corporation, Amphenol Aerospace, Sidney NY 13838-1395. FSCM 77820

** Except for MB with compliant contacts; consult Amphenol, Sidney, NY for details.



REMOVE DAMAGED CONTACT



INSERT EXTRACTION TOOL WITH PLUNGER RETRACTED

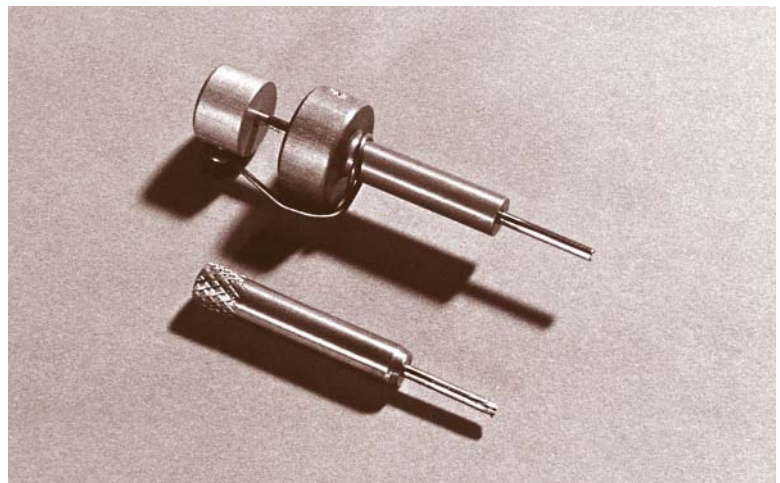

11-10368 EXTRACTION TOOL AND 11-10372 INSERTION TOOL

Low Mating Force

contact installation instructions, repair/replacement

Using the thumb, push the plunger portion of the Extraction Tool through the holder body into the damaged contact until a slight resistance is felt. DO NOT PUSH PLUNGER HARD ENOUGH TO CLOSE THE GAP BETWEEN IT AND THE HOLDER BODY. The contact is now ready to be removed.

While maintaining slight pressure on the plunger, withdraw tool and contact through the front of the connector body. Discard damaged contact.

CONTACT REPLACEMENT/INSERTION - MB, PC SERIES *

Using tweezers or fingers, carefully place the replacement contact TAIL FIRST into the appropriate contact cavity in the front of the connector. Push contact tail into the cavity until the tail centers in the molded locating ribs. DO NOT push against the bristle wires.

Position the tube end of the 11-10372 Insertion Tool over the brush contact wires. Be careful not to bend any bristle strands. Before final seating of the contact it is necessary to make provisions for proper dressing of the contact tail back into the printed circuit board hole. In the case of a 90° tail situation, extra care must be taken to dress the contact as it is being seated.

Push contact into cavity using the Insertion Tool until a positive stop is felt. Remove tool. Contact is now ready for termination.

CONTACT REMOVAL - IO-C SERIES

Contact removal is accomplished from the rear of this connector series. Determine which contact is to be removed and locate its corresponding wire in the wire bundle. Position wire in Removal Tool (white). Slide tool along wire and insert into rear of connector body. A moderate amount of resistance will be encountered until the contact retention tines are deflected, and then a positive stop will be felt. Then, holding the wire in tension with the thumb against the tool serrations, withdraw tool, wire and contact in one steady motion. Cut off and discard damaged contact.

CONTACT REPLACEMENT/INSERTION - IO-C SERIES

Using accepted industry procedures, strip wire end to be terminated 1/8 to 5/32 inch. Care should be taken not to nick wire strands. Assemble the M22520/2-01 Crimp Tool and Daniels K743 Positioner and place Tool Selector in correct setting for wire size being used as follows:

AWG	22	24	26	28
SEL	5	4	3	2

Insert stripped wire end into contact wire well. Strands should be visible in wire well inspection hole. Bottom contact and wire assembly in Positioner and close handles of Crimp Tool to complete crimp. Handles will not open unless full crimping cycle has been completed. Position crimped wire and contact in Insertion tool (brown). Snug insertion tip around contact.

Insert contact and wire assembly into rear of connector. Push tool gently forward until contact is fully seated. Withdraw tool and remove from wire. A slight pull on the wire assures retention. Redress wire bundle.

* Except for MB with compliant contacts; consult Amphenol, Sidney, NY for details.



SEAT PLUNGER AND REMOVE CONTACT AND TOOL



SEAT CONTACT WITH INSERTION TOOL



INSERT REPLACEMENT CONTACT

Low Mating Force mother board connector

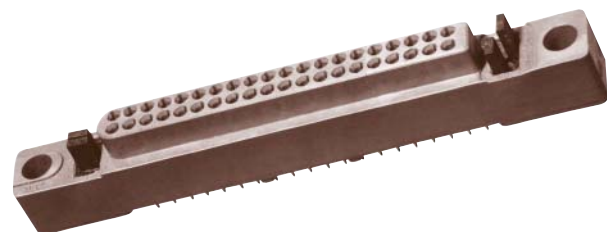
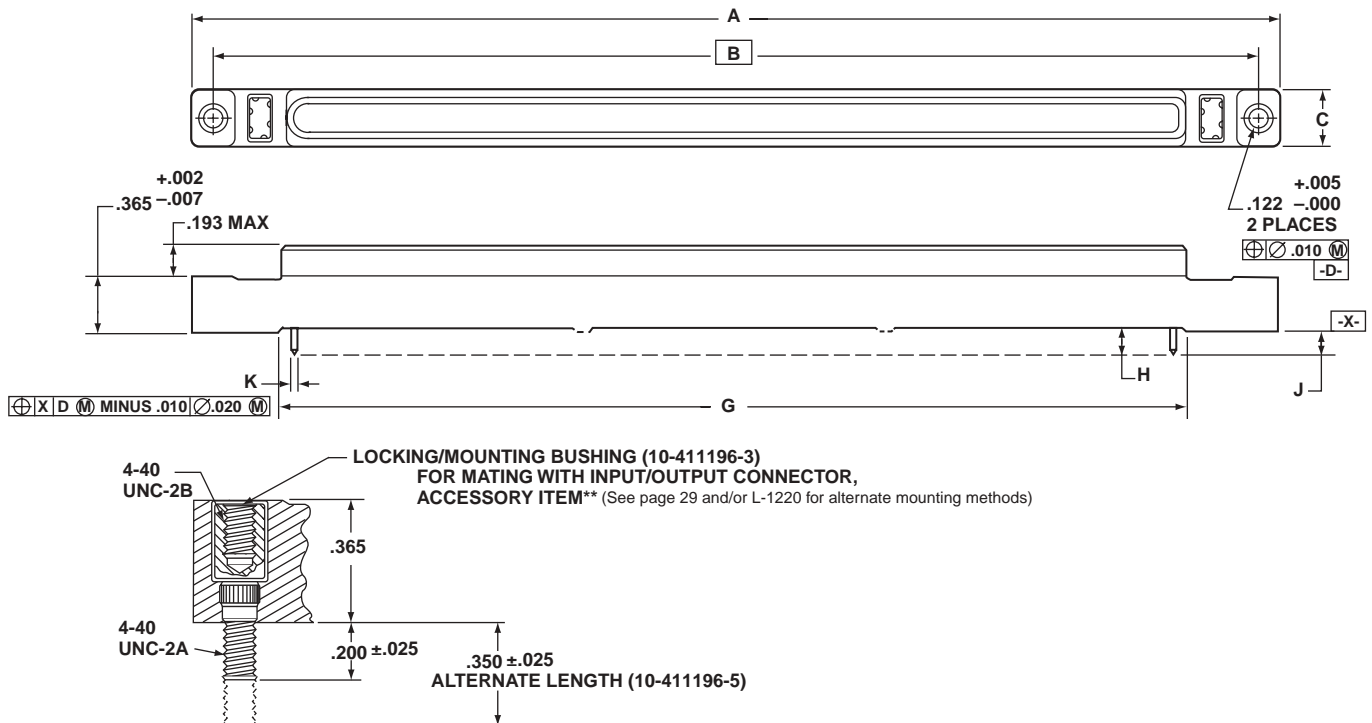

MATES WITH DB AND IO SERIES CONNECTORS

Notes:

When mating with DB connector, a total of .035 inch minimum radial pilot is available for connector body alignment.

All dimensions for reference only.

Polarization keys are not supplied as part of MB Connector Series assemblies. See How to Order, page 7 and further description, page 28.

** Not supplied as part of MB Connector Series assemblies.

See How to Order, page 7.

□ Designates Basic Dimension

Consult Amphenol drawing for solderless wrap contact fixturing (datum) hole locations to facilitate connector alignment.

Description	Contact Data				
	Termination Style Letter	Contact Part Number	H ±.020	J ±.020	K ±.002
Round PCB	P	10-502403-11	.148	.113	.021 Dia.
Stud Solder Termination	P-(702)	10-502403-21	.180	.145	.021 Dia.
	P-(709)	10-502403-31	.335	.300	.021 Dia.
Square Solderless Wrap Termination	W	10-502406-11	.542	.507	.025 Sq.
	W-(710)	10-502406-21	.700	.665	.025 Sq.

NOTE: Other variations available - see pages 7 and 8, or consult Sidney, NY.

Low Mating Force mother board connector 2 row contact arrangements

Number of Contacts	MB Number*	A Max.	B	C Max.	G Min.
020	MB2-020(*)	2.295	1.975	.390	1.040
022	MB2-022(*)	2.395	2.075	.390	1.140
024	MB2-024(*)	2.495	2.175	.390	1.240
026	MB2-026(*)	2.595	2.275	.390	1.340
028	MB2-028(*)	2.695	2.375	.390	1.440
030	MB2-030(*)	2.795	2.475	.390	1.540
032	MB2-032(*)	2.895	2.575	.390	1.640
034	MB2-034(*)	2.995	2.675	.390	1.740
036	MB2-036(*)	3.095	2.775	.390	1.840
038	MB2-038(*)	3.195	2.875	.390	1.940
040	MB2-040(*)	3.295	2.975	.390	2.040
042	MB2-042(*)	3.395	3.075	.390	2.140
044	MB2-044(*)	3.495	3.175	.390	2.240
046	MB2-046(*)	3.595	3.275	.390	2.340
048	MB2-048(*)	3.695	3.375	.390	2.440
050	MB2-050(*)	3.795	3.475	.390	2.540
052	MB2-052(*)	3.895	3.575	.390	2.640
054	MB2-054(*)	3.995	3.675	.390	2.740
056	MB2-056(*)	4.095	3.775	.390	2.840
058	MB2-058(*)	4.195	3.875	.390	2.940
060	MB2-060(*)	4.295	3.975	.390	3.040
062	MB2-062(*)	4.395	4.075	.390	3.140
064	MB2-064(*)	4.495	4.175	.390	3.240
066	MB2-066(*)	4.595	4.275	.390	3.340
068	MB2-068(*)	4.695	4.375	.390	3.440
070	MB2-070(*)	4.795	4.475	.390	3.540
072	MB2-072(*)	4.895	4.575	.390	3.640
074	MB2-074(*)	4.995	4.675	.390	3.740
076	MB2-076(*)	5.095	4.775	.390	3.840
078	MB2-078(*)	5.195	4.875	.390	3.940
080	MB2-080(*)	5.295	4.975	.390	4.040
082	MB2-082(*)	5.395	5.075	.390	4.140
084	MB2-084(*)	5.495	5.175	.390	4.240
086	MB2-086(*)	5.595	5.275	.390	4.340
088	MB2-088(*)	5.695	5.375	.390	4.440
090	MB2-090(*)	5.795	5.475	.390	4.540
092	MB2-092(*)	5.895	5.575	.390	4.640
094	MB2-094(*)	5.995	5.675	.390	4.740
096	MB2-096(*)	6.095	5.775	.390	4.840
098	MB2-098(*)	6.195	5.875	.390	4.940
100	MB2-100(*)	6.295	5.975	.390	5.040
102	MB2-102(*)	6.395	6.075	.390	5.140
104	MB2-104(*)	6.495	6.175	.390	5.240
106	MB2-106(*)	6.595	6.275	.390	5.340
108	MB2-108(*)	6.695	6.375	.390	5.440
110	MB2-110(*)	6.795	6.475	.390	5.540

Number of Contacts	MB Number*	A Max.	B	C Max.	G Min.
112	MB2-112(*)	6.895	6.575	.390	5.640
114	MB2-114(*)	6.995	6.675	.390	5.740
116	MB2-116(*)	7.095	6.775	.390	5.840
118	MB2-118(*)	7.195	6.875	.390	5.940
120	MB2-120(*)	7.295	6.975	.390	6.040
122	MB2-122(*)	7.395	7.075	.390	6.140
124	MB2-124(*)	7.495	7.175	.390	6.240
126	MB2-126(*)	7.595	7.275	.390	6.340
128	MB2-128(*)	7.695	7.375	.390	6.440
130	MB2-130(*)	7.795	7.475	.390	6.540
132	MB2-132(*)	7.895	7.575	.390	6.640
134	MB2-134(*)	7.995	7.675	.390	6.740
136	MB2-136(*)	8.095	7.775	.390	6.840
138	MB2-138(*)	8.195	7.875	.390	6.940
140	MB2-140(*)	8.295	7.975	.390	7.040
142	MB2-142(*)	8.395	8.075	.390	7.140
144	MB2-144(*)	8.495	8.175	.390	7.240
146	MB2-146(*)	8.595	8.275	.390	7.340
148	MB2-148(*)	8.695	8.375	.390	7.440
150	MB2-150(*)	8.795	8.475	.390	7.540
152	MB2-152(*)	8.895	8.575	.390	7.640
154	MB2-154(*)	8.995	8.675	.390	7.740
156	MB2-156(*)	9.095	8.775	.390	7.840
158	MB2-158(*)	9.195	8.875	.390	7.940
160	MB2-160(*)	9.295	8.975	.390	8.040
162	MB2-162(*)	9.395	9.075	.390	8.140
164	MB2-164(*)	9.495	9.175	.390	8.240
166	MB2-166(*)	9.595	9.275	.390	8.340
168	MB2-168(*)	9.695	9.375	.390	8.440
170	MB2-170(*)	9.795	9.475	.390	8.540
172	MB2-172(*)	9.895	9.575	.390	8.640
174	MB2-174(*)	9.995	9.675	.390	8.740
176	MB2-176(*)	10.095	9.775	.390	8.840
178	MB2-178(*)	10.195	9.875	.390	8.940
180	MB2-180(*)	10.295	9.975	.390	9.040
182	MB2-182(*)	10.395	10.075	.390	9.140
184	MB2-184(*)	10.495	10.175	.390	9.240
186	MB2-186(*)	10.595	10.275	.390	9.340
188	MB2-188(*)	10.695	10.375	.390	9.440
190	MB2-190(*)	10.795	10.475	.390	9.540
192	MB2-192(*)	10.895	10.575	.390	9.640
194	MB2-194(*)	10.995	10.675	.390	9.740
196	MB2-196(*)	11.095	10.775	.390	9.840
198	MB2-198(*)	11.195	10.875	.390	9.940
200	MB2-200(*)	11.295	10.975	.390	10.040

*See How to Order, pages 5, 6 and 7

Low Mating Force

mother board connector

3 row contact arrangements

Number of Contacts	MB Number*	A Max.	B	C Max.	G Min.
030	MB3-030(*)	2.295	1.975	.490	1.040
033	MB3-033(*)	2.395	2.075	.490	1.140
036	MB3-036(*)	2.495	2.175	.490	1.240
039	MB3-039(*)	2.595	2.275	.490	1.340
042	MB3-042(*)	2.695	2.375	.490	1.440
045	MB3-045(*)	2.795	2.475	.490	1.540
048	MB3-048(*)	2.895	2.575	.490	1.640
051	MB3-051(*)	2.995	2.675	.490	1.740
054	MB3-054(*)	3.095	2.775	.490	1.840
057	MB3-057(*)	3.195	2.875	.490	1.940
060	MB3-060(*)	3.295	2.975	.490	2.040
063	MB3-063(*)	3.395	3.075	.490	2.140
066	MB3-066(*)	3.495	3.175	.490	2.240
069	MB3-069(*)	3.595	3.275	.490	2.340
072	MB3-072(*)	3.695	3.375	.490	2.440
075	MB3-075(*)	3.795	3.475	.490	2.540
078	MB3-078(*)	3.895	3.575	.490	2.640
081	MB3-081(*)	3.995	3.675	.490	2.740
084	MB3-084(*)	4.095	3.775	.490	2.840
087	MB3-087(*)	4.195	3.875	.490	2.940
090	MB3-090(*)	4.295	3.975	.490	3.040
093	MB3-093(*)	4.395	4.075	.490	3.140
096	MB3-096(*)	4.495	4.175	.490	3.240
099	MB3-099(*)	4.595	4.275	.490	3.340
102	MB3-102(*)	4.695	4.375	.490	3.440
105	MB3-105(*)	4.795	4.475	.490	3.540
108	MB3-108(*)	4.895	4.575	.490	3.640
111	MB3-111(*)	4.995	4.675	.490	3.740
114	MB3-114(*)	5.095	4.775	.490	3.840
117	MB3-117(*)	5.195	4.875	.490	3.940
120	MB3-120(*)	5.295	4.975	.490	4.040
123	MB3-123(*)	5.395	5.075	.490	4.140
126	MB3-126(*)	5.495	5.175	.490	4.240
129	MB3-129(*)	5.595	5.275	.490	4.340
132	MB3-132(*)	5.695	5.375	.490	4.440
135	MB3-135(*)	5.795	5.475	.490	4.540
138	MB3-138(*)	5.895	5.575	.490	4.640
141	MB3-141(*)	5.995	5.675	.490	4.740
144	MB3-144(*)	6.095	5.775	.490	4.840
147	MB3-147(*)	6.195	5.875	.490	4.940
150	MB3-150(*)	6.295	5.975	.490	5.040
153	MB3-153(*)	6.395	6.075	.490	5.140
156	MB3-156(*)	6.495	6.175	.490	5.240
159	MB3-159(*)	6.595	6.275	.490	5.340
162	MB3-162(*)	6.695	6.375	.490	5.440
165	MB3-165(*)	6.795	6.475	.490	5.540

Number of Contacts	MB Number*	A Max.	B	C Max.	G Min.
168	MB3-168(*)	6.895	6.575	.490	5.640
171	MB3-171(*)	6.995	6.675	.490	5.740
174	MB3-174(*)	7.095	6.775	.490	5.840
177	MB3-177(*)	7.195	6.875	.490	5.940
180	MB3-180(*)	7.295	6.975	.490	6.040
183	MB3-183(*)	7.395	7.075	.490	6.140
186	MB3-186(*)	7.495	7.175	.490	6.240
189	MB3-189(*)	7.595	7.275	.490	6.340
192	MB3-192(*)	7.695	7.375	.490	6.440
195	MB3-195(*)	7.795	7.475	.490	6.540
198	MB3-198(*)	7.895	7.575	.490	6.640
201	MB3-201(*)	7.995	7.675	.490	6.740
204	MB3-204(*)	8.095	7.775	.490	6.840
207	MB3-207(*)	8.195	7.875	.490	6.940
210	MB3-210(*)	8.295	7.975	.490	7.040
213	MB3-213(*)	8.395	8.075	.490	7.140
216	MB3-216(*)	8.495	8.175	.490	7.240
219	MB3-219(*)	8.595	8.275	.490	7.340
222	MB3-222(*)	8.695	8.375	.490	7.440
225	MB3-225(*)	8.795	8.475	.490	7.540
228	MB3-228(*)	8.895	8.575	.490	7.640
231	MB3-231(*)	8.995	8.675	.490	7.740
234	MB3-234(*)	9.095	8.775	.490	7.840
237	MB3-237(*)	9.195	8.875	.490	7.940
240	MB3-240(*)	9.295	8.975	.490	8.040
243	MB3-243(*)	9.395	9.075	.490	8.140
246	MB3-246(*)	9.495	9.175	.490	8.240
249	MB3-249(*)	9.595	9.275	.490	8.340
252	MB3-252(*)	9.695	9.375	.490	8.440
255	MB3-255(*)	9.795	9.475	.490	8.540
258	MB3-258(*)	9.895	9.575	.490	8.640
261	MB3-261(*)	9.995	9.675	.490	8.740
264	MB3-264(*)	10.095	9.775	.490	8.840
267	MB3-267(*)	10.195	9.875	.490	8.940
270	MB3-270(*)	10.295	9.975	.490	9.040
273	MB3-273(*)	10.395	10.075	.490	9.140
276	MB3-276(*)	10.495	10.175	.490	9.240
279	MB3-279(*)	10.595	10.275	.490	9.340
282	MB3-282(*)	10.695	10.375	.490	9.440
285	MB3-285(*)	10.795	10.475	.490	9.540
288	MB3-288(*)	10.895	10.575	.490	9.640
291	MB3-291(*)	10.995	10.675	.490	9.740
294	MB3-294(*)	11.095	10.775	.490	9.840
297	MB3-297(*)	11.195	10.875	.490	9.940
300	MB3-300(*)	11.295	10.975	.490	10.040

*See How to Order, pages 5, 6 and 7

Low Mating Force mother board connector 4 row contact arrangements

Number of Contacts	MB Number*	A Max.	B	C Max.	G Min.
040	MB4-040(*)	2.295	1.975	.590	1.040
044	MB4-044(*)	2.395	2.075	.590	1.140
048	MB4-048(*)	2.495	2.175	.590	1.240
052	MB4-052(*)	2.595	2.275	.590	1.340
056	MB4-056(*)	2.695	2.375	.590	1.440
060	MB4-060(*)	2.795	2.475	.590	1.540
064	MB4-064(*)	2.895	2.575	.590	1.640
068	MB4-068(*)	2.995	2.675	.590	1.740
072	MB4-072(*)	3.095	2.775	.590	1.840
076	MB4-076(*)	3.195	2.875	.590	1.940
080	MB4-080(*)	3.295	2.975	.590	2.040
084	MB4-084(*)	3.395	3.075	.590	2.140
088	MB4-088(*)	3.495	3.175	.590	2.240
092	MB4-092(*)	3.595	3.275	.590	2.340
096	MB4-096(*)	3.695	3.375	.590	2.440
100	MB4-100(*)	3.795	3.475	.590	2.540
104	MB4-104(*)	3.895	3.575	.590	2.640
108	MB4-108(*)	3.995	3.675	.590	2.740
112	MB4-112(*)	4.095	3.775	.590	2.840
116	MB4-116(*)	4.195	3.875	.590	2.940
120	MB4-120(*)	4.295	3.975	.590	3.040
124	MB4-124(*)	4.395	4.075	.590	3.140
128	MB4-128(*)	4.495	4.175	.590	3.240
132	MB4-132(*)	4.595	4.275	.590	3.340
136	MB4-136(*)	4.695	4.375	.590	3.440
140	MB4-140(*)	4.795	4.475	.590	3.540
144	MB4-144(*)	4.895	4.575	.590	3.640
148	MB4-148(*)	4.995	4.675	.590	3.740
152	MB4-152(*)	5.095	4.775	.590	3.840
156	MB4-156(*)	5.195	4.875	.590	3.940
160	MB4-160(*)	5.295	4.975	.590	4.040
164	MB4-164(*)	5.395	5.075	.590	4.140
168	MB4-168(*)	5.495	5.175	.590	4.240
172	MB4-172(*)	5.595	5.275	.590	4.340
176	MB4-176(*)	5.695	5.375	.590	4.440
180	MB4-180(*)	5.795	5.475	.590	4.540
184	MB4-184(*)	5.895	5.575	.590	4.640
188	MB4-188(*)	5.995	5.675	.590	4.740
192	MB4-192(*)	6.095	5.775	.590	4.840
196	MB4-196(*)	6.195	5.875	.590	4.940
200	MB4-200(*)	6.295	5.975	.590	5.040
204	MB4-204(*)	6.395	6.075	.590	5.140
208	MB4-208(*)	6.495	6.175	.590	5.240
212	MB4-212(*)	6.595	6.275	.590	5.340
216	MB4-216(*)	6.695	6.375	.590	5.440
220	MB4-220(*)	6.795	6.475	.590	5.540

Number of Contacts	MB Number*	A Max.	B	C Max.	G Min.
224	MB4-224(*)	6.895	6.575	.590	5.640
228	MB4-228(*)	6.995	6.675	.590	5.740
232	MB4-232(*)	7.095	6.775	.590	5.840
236	MB4-236(*)	7.195	6.875	.590	5.940
240	MB4-240(*)	7.295	6.975	.590	6.040
244	MB4-244(*)	7.395	7.075	.590	6.140
248	MB4-248(*)	7.495	7.175	.590	6.240
252	MB4-252(*)	7.595	7.275	.590	6.340
256	MB4-256(*)	7.695	7.375	.590	6.440
260	MB4-260(*)	7.795	7.475	.590	6.540
264	MB4-264(*)	7.895	7.575	.590	6.640
268	MB4-268(*)	7.995	7.675	.590	6.740
272	MB4-272(*)	8.095	7.775	.590	6.840
276	MB4-276(*)	8.195	7.875	.590	6.940
280	MB4-280(*)	8.295	7.975	.590	7.040
284	MB4-284(*)	8.395	8.075	.590	7.140
288	MB4-288(*)	8.495	8.175	.590	7.240
292	MB4-292(*)	8.595	8.275	.590	7.340
296	MB4-296(*)	8.695	8.375	.590	7.440
300	MB4-300(*)	8.795	8.475	.590	7.540
304	MB4-304(*)	8.895	8.575	.590	7.640
308	MB4-308(*)	8.995	8.675	.590	7.740
312	MB4-312(*)	9.095	8.775	.590	7.840
316	MB4-316(*)	9.195	8.875	.590	7.940
320	MB4-320(*)	9.295	8.975	.590	8.040
324	MB4-324(*)	9.395	9.075	.590	8.140
328	MB4-328(*)	9.495	9.175	.590	8.240
332	MB4-332(*)	9.595	9.275	.590	8.340
336	MB4-336(*)	9.695	9.375	.590	8.440
340	MB4-340(*)	9.795	9.475	.590	8.540
344	MB4-344(*)	9.895	9.575	.590	8.640
348	MB4-348(*)	9.995	9.675	.590	8.740
352	MB4-352(*)	10.095	9.775	.590	8.840
356	MB4-356(*)	10.195	9.875	.590	8.940
360	MB4-360(*)	10.295	9.975	.590	9.040
364	MB4-364(*)	10.395	10.075	.590	9.140
368	MB4-368(*)	10.495	10.175	.590	9.240
372	MB4-372(*)	10.595	10.275	.590	9.340
376	MB4-376(*)	10.695	10.375	.590	9.440
380	MB4-380(*)	10.795	10.475	.590	9.540
384	MB4-384(*)	10.895	10.575	.590	9.640
388	MB4-388(*)	10.995	10.675	.590	9.740
392	MB4-392(*)	11.095	10.775	.590	9.840
396	MB4-396(*)	11.195	10.875	.590	9.940
400	MB4-400(*)	11.295	10.975	.590	10.040

*See How to Order, pages 5, 6 and 7

Low Mating Force daughter board connector

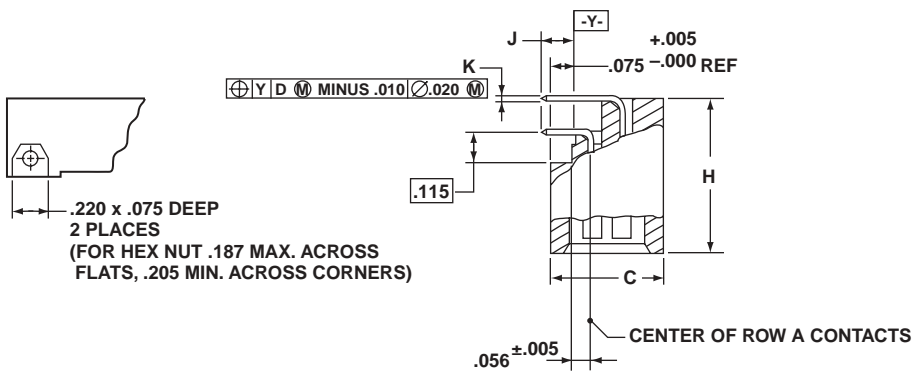

MATES WITH MB AND PC SERIES CONNECTORS

Notes:

When mating with MB or PC connector, a total of .035 inch minimum radial pilot is available for connector body alignment.

All dimensions for reference only.

Polarization keys are not supplied as part of DB Connector Series assemblies. See How to Order, page 7 and further description, page 28.

□ Designates Basic Dimension

Description	Contact Data				
	Termination Style Letter	Arrangement Row	Contact Part Number	J ±.020	K ±.002
Round PCB Stud, 90° Solder Termination	P	A	10-502400-111	.085	.021 Dia.
	P	B	10-502400-211	.085	.021 Dia.
	P	C	10-502400-311	.085	.021 Dia.
	P	D	10-502400-411	.085	.021 Dia.
	P-(705)	A	10-502400-121	.120	.021 Dia.
	P-(705)	B	10-502400-221	.120	.021 Dia.
	P-(705)	C	10-502400-321	.120	.021 Dia.
	P-(705)	D	10-502400-421	.120	.021 Dia.
	P-(709)	A	10-502400-131	.300	.021 Dia.
	P-(709)	B	10-502400-231	.300	.021 Dia.
P-(709)	C	10-502400-331	.300	.021 Dia.	
P-(709)	D	10-502400-431	.300	.021 Dia.	

NOTE: Other variations available - see pages 7 and 8, or consult Sidney, NY.

Low Mating Force daughter board connector 2 row contact arrangements

Number of Contacts	DB Number*	A Max.	B	C Max.	H Max.	AA
020	DB2-020P	1.680	1.350	.375	.545	.900
022	DB2-022P	1.780	1.450	.375	.545	1.000
024	DB2-024P	1.880	1.550	.375	.545	1.100
026	DB2-026P	1.980	1.650	.375	.545	1.200
028	DB2-028P	2.080	1.750	.375	.545	1.300
030	DB2-030P	2.180	1.850	.375	.545	1.400
032	DB2-032P	2.280	1.950	.375	.545	1.500
034	DB2-034P	2.380	2.050	.375	.545	1.600
036	DB2-036P	2.480	2.150	.375	.545	1.700
038	DB2-038P	2.580	2.250	.375	.545	1.800
040	DB2-040P	2.680	2.350	.375	.545	1.900
042	DB2-042P	2.780	2.450	.375	.545	2.000
044	DB2-044P	2.880	2.550	.375	.545	2.100
046	DB2-046P	2.980	2.650	.375	.545	2.200
048	DB2-048P	3.080	2.750	.375	.545	2.300
050	DB2-050P	3.180	2.850	.375	.545	2.400
052	DB2-052P	3.280	2.950	.375	.545	2.500
054	DB2-054P	3.380	3.050	.375	.545	2.600
056	DB2-056P	3.480	3.150	.375	.545	2.700
058	DB2-058P	3.580	3.250	.375	.545	2.800
060	DB2-060P	3.680	3.350	.375	.545	2.900
062	DB2-062P	3.780	3.450	.375	.545	3.000
064	DB2-064P	3.880	3.550	.375	.545	3.100
066	DB2-066P	3.980	3.650	.375	.545	3.200
068	DB2-068P	4.080	3.750	.375	.545	3.300
070	DB2-070P	4.180	3.850	.375	.545	3.400
072	DB2-072P	4.280	3.950	.375	.545	3.500
074	DB2-074P	4.380	4.050	.375	.545	3.600
076	DB2-076P	4.480	4.150	.375	.545	3.700
078	DB2-078P	4.580	4.250	.375	.545	3.800
080	DB2-080P	4.680	4.350	.375	.545	3.900
082	DB2-082P	4.780	4.450	.375	.545	4.000
084	DB2-084P	4.880	4.550	.375	.545	4.100
086	DB2-086P	4.980	4.650	.375	.545	4.200
088	DB2-088P	5.080	4.750	.375	.545	4.300
090	DB2-090P	5.180	4.850	.375	.545	4.400
092	DB2-092P	5.280	4.950	.375	.545	4.500
094	DB2-094P	5.380	5.050	.375	.545	4.600
096	DB2-096P	5.480	5.150	.375	.545	4.700
098	DB2-098P	5.580	5.250	.375	.545	4.800
100	DB2-100P	5.680	5.350	.375	.545	4.900
102	DB2-102P	5.780	5.450	.375	.545	5.000
104	DB2-104P	5.880	5.550	.375	.545	5.100
106	DB2-106P	5.980	5.650	.375	.545	5.200
108	DB2-108P	6.080	5.750	.375	.545	5.300
110	DB2-110P	6.180	5.850	.375	.545	5.400

Number of Contacts	DB Number*	A Max.	B	C Max.	H Max.	AA
112	DB2-112P	6.280	5.950	.375	.545	5.500
114	DB2-114P	6.380	6.050	.375	.545	5.600
116	DB2-116P	6.480	6.150	.375	.545	5.700
118	DB2-118P	6.580	6.250	.375	.545	5.800
120	DB2-120P	6.680	6.350	.375	.545	5.900
122	DB2-122P	6.780	6.450	.375	.545	6.000
124	DB2-124P	6.880	6.550	.375	.545	6.100
126	DB2-126P	6.980	6.650	.375	.545	6.200
128	DB2-128P	7.080	6.750	.375	.545	6.300
130	DB2-130P	7.180	6.850	.375	.545	6.400
132	DB2-132P	7.280	6.950	.375	.545	6.500
134	DB2-134P	7.380	7.050	.375	.545	6.600
136	DB2-136P	7.480	7.150	.375	.545	6.700
138	DB2-138P	7.580	7.250	.375	.545	6.800
140	DB2-140P	7.680	7.350	.375	.545	6.900
142	DB2-142P	7.780	7.450	.375	.545	7.000
144	DB2-144P	7.880	7.550	.375	.545	7.100
146	DB2-146P	7.980	7.650	.375	.545	7.200
148	DB2-148P	8.080	7.750	.375	.545	7.300
150	DB2-150P	8.180	7.850	.375	.545	7.400
152	DB2-152P	8.280	7.950	.375	.545	7.500
154	DB2-154P	8.380	8.050	.375	.545	7.600
156	DB2-156P	8.480	8.150	.375	.545	7.700
158	DB2-158P	8.580	8.250	.375	.545	7.800
160	DB2-160P	8.680	8.350	.375	.545	7.900
162	DB2-162P	8.780	8.450	.375	.545	8.000
164	DB2-164P	8.880	8.550	.375	.545	8.100
166	DB2-166P	8.980	8.650	.375	.545	8.200
168	DB2-168P	9.080	8.750	.375	.545	8.300
170	DB2-170P	9.180	8.850	.375	.545	8.400
172	DB2-172P	9.280	8.950	.375	.545	8.500
174	DB2-174P	9.380	9.050	.375	.545	8.600
176	DB2-176P	9.480	9.150	.375	.545	8.700
178	DB2-178P	9.580	9.250	.375	.545	8.800
180	DB2-180P	9.680	9.350	.375	.545	8.900
182	DB2-182P	9.780	9.450	.375	.545	9.000
184	DB2-184P	9.880	9.550	.375	.545	9.100
186	DB2-186P	9.980	9.650	.375	.545	9.200
188	DB2-188P	10.080	9.750	.375	.545	9.300
190	DB2-190P	10.180	9.850	.375	.545	9.400
192	DB2-192P	10.280	9.950	.375	.545	9.500
194	DB2-194P	10.380	10.050	.375	.545	9.600
196	DB2-196P	10.480	10.150	.375	.545	9.700
198	DB2-198P	10.580	10.250	.375	.545	9.800
200	DB2-200P	10.680	10.350	.375	.545	9.900

*See How to Order, pages 5, 6 and 7

Low Mating Force daughter board connector 3 row contact arrangements

Number of Contacts	DB Number*	A Max.	B	C Max.	H Max.	AA
030	DB3-030P	1.680	1.350	.475	.645	.900
033	DB3-033P	1.780	1.450	.475	.645	1.000
036	DB3-036P	1.880	1.550	.475	.645	1.100
039	DB3-039P	1.980	1.650	.475	.645	1.200
042	DB3-042P	2.080	1.750	.475	.645	1.300
045	DB3-045P	2.180	1.850	.475	.645	1.400
048	DB3-048P	2.280	1.950	.475	.645	1.500
051	DB3-051P	2.380	2.050	.475	.645	1.600
054	DB3-054P	2.480	2.150	.475	.645	1.700
057	DB3-057P	2.580	2.250	.475	.645	1.800
060	DB3-060P	2.680	2.350	.475	.645	1.900
063	DB3-063P	2.780	2.450	.475	.645	2.000
066	DB3-066P	2.880	2.550	.475	.645	2.100
069	DB3-069P	2.980	2.650	.475	.645	2.200
072	DB3-072P	3.080	2.750	.475	.645	2.300
075	DB3-075P	3.180	2.850	.475	.645	2.400
078	DB3-078P	3.280	2.950	.475	.645	2.500
081	DB3-081P	3.380	3.050	.475	.645	2.600
084	DB3-084P	3.480	3.150	.475	.645	2.700
087	DB3-087P	3.580	3.250	.475	.645	2.800
090	DB3-090P	3.680	3.350	.475	.645	2.900
093	DB3-093P	3.780	3.450	.475	.645	3.000
096	DB3-096P	3.880	3.550	.475	.645	3.100
099	DB3-099P	3.980	3.650	.475	.645	3.200
102	DB3-102P	4.080	3.750	.475	.645	3.300
105	DB3-105P	4.180	3.850	.475	.645	3.400
108	DB3-108P	4.280	3.950	.475	.645	3.500
111	DB3-111P	4.380	4.050	.475	.645	3.600
114	DB3-114P	4.480	4.150	.475	.645	3.700
117	DB3-117P	4.580	4.250	.475	.645	3.800
120	DB3-120P	4.680	4.350	.475	.645	3.900
123	DB3-123P	4.780	4.450	.475	.645	4.000
126	DB3-126P	4.880	4.550	.475	.645	4.100
129	DB3-129P	4.980	4.650	.475	.645	4.200
132	DB3-132P	5.080	4.750	.475	.645	4.300
135	DB3-135P	5.180	4.850	.475	.645	4.400
138	DB3-138P	5.280	4.950	.475	.645	4.500
141	DB3-141P	5.380	5.050	.475	.645	4.600
144	DB3-144P	5.480	5.150	.475	.645	4.700
147	DB3-147P	5.580	5.250	.475	.645	4.800
150	DB3-150P	5.680	5.350	.475	.645	4.900
153	DB3-153P	5.780	5.450	.475	.645	5.000
156	DB3-156P	5.880	5.550	.475	.645	5.100
159	DB3-159P	5.980	5.650	.475	.645	5.200
162	DB3-162P	6.080	5.750	.475	.645	5.300
165	DB3-165P	6.180	5.850	.475	.645	5.400

Number of Contacts	DB Number*	A Max.	B	C Max.	H Max.	AA
168	DB3-168P	6.280	5.950	.475	.645	5.500
171	DB3-171P	6.380	6.050	.475	.645	5.600
174	DB3-174P	6.480	6.150	.475	.645	5.700
177	DB3-177P	6.580	6.250	.475	.645	5.800
180	DB3-180P	6.680	6.350	.475	.645	5.900
183	DB3-183P	6.780	6.450	.475	.645	6.000
186	DB3-186P	6.880	6.550	.475	.645	6.100
189	DB3-189P	6.980	6.650	.475	.645	6.200
192	DB3-192P	7.080	6.750	.475	.645	6.300
195	DB3-195P	7.180	6.850	.475	.645	6.400
198	DB3-198P	7.280	6.950	.475	.645	6.500
201	DB3-201P	7.380	7.050	.475	.645	6.600
204	DB3-204P	7.480	7.150	.475	.645	6.700
207	DB3-207P	7.580	7.250	.475	.645	6.800
210	DB3-210P	7.680	7.350	.475	.645	6.900
213	DB3-213P	7.780	7.450	.475	.645	7.000
216	DB3-216P	7.880	7.550	.475	.645	7.100
219	DB3-219P	7.980	7.650	.475	.645	7.200
222	DB3-222P	8.080	7.750	.475	.645	7.300
225	DB3-225P	8.180	7.850	.475	.645	7.400
228	DB3-228P	8.280	7.950	.475	.645	7.500
231	DB3-231P	8.380	8.050	.475	.645	7.600
234	DB3-234P	8.480	8.150	.475	.645	7.700
237	DB3-237P	8.580	8.250	.475	.645	7.800
240	DB3-240P	8.680	8.350	.475	.645	7.900
243	DB3-243P	8.780	8.450	.475	.645	8.000
246	DB3-246P	8.880	8.550	.475	.645	8.100
249	DB3-249P	8.980	8.650	.475	.645	8.200
252	DB3-252P	9.080	8.750	.475	.645	8.300
255	DB3-255P	9.180	8.850	.475	.645	8.400
258	DB3-258P	9.280	8.950	.475	.645	8.500
261	DB3-261P	9.380	9.050	.475	.645	8.600
264	DB3-264P	9.480	9.150	.475	.645	8.700
267	DB3-267P	9.580	9.250	.475	.645	8.800
270	DB3-270P	9.680	9.350	.475	.645	8.900
273	DB3-273P	9.780	9.450	.475	.645	9.000
276	DB3-276P	9.880	9.550	.475	.645	9.100
279	DB3-279P	9.980	9.650	.475	.645	9.200
282	DB3-282P	10.080	9.750	.475	.645	9.300
285	DB3-285P	10.180	9.850	.475	.645	9.400
288	DB3-288P	10.280	9.950	.475	.645	9.500
291	DB3-291P	10.380	10.050	.475	.645	9.600
294	DB3-294P	10.480	10.150	.475	.645	9.700
297	DB3-397P	10.580	10.250	.475	.645	9.800
300	DB3-300P	10.680	10.350	.475	.645	9.900

*See How to Order, pages 5, 6 and 7

Low Mating Force daughter board connector 4 row contact arrangements

Number of Contacts	DB Number*	A Max.	B	C Max.	H Max.	AA
040	DB4-040P	1.680	1.350	.575	.745	.900
044	DB4-044P	1.780	1.450	.575	.745	1.000
048	DB4-048P	1.880	1.550	.575	.745	1.100
052	DB4-052P	1.980	1.650	.575	.745	1.200
056	DB4-056P	2.080	1.750	.575	.745	1.300
060	DB4-060P	2.180	1.850	.575	.745	1.400
064	DB4-064P	2.280	1.950	.575	.745	1.500
068	DB4-068P	2.380	2.050	.575	.745	1.600
072	DB4-072P	2.480	2.150	.575	.745	1.700
076	DB4-076P	2.580	2.250	.575	.745	1.800
080	DB4-080P	2.680	2.350	.575	.745	1.900
084	DB4-084P	2.780	2.450	.575	.745	2.000
088	DB4-088P	2.880	2.550	.575	.745	2.100
092	DB4-092P	2.980	2.650	.575	.745	2.200
096	DB4-096P	3.080	2.750	.575	.745	2.300
100	DB4-100P	3.180	2.850	.575	.745	2.400
104	DB4-104P	3.280	2.950	.575	.745	2.500
108	DB4-108P	3.380	3.050	.575	.745	2.600
112	DB4-112P	3.480	3.150	.575	.745	2.700
116	DB4-116P	3.580	3.250	.575	.745	2.800
120	DB4-120P	3.680	3.350	.575	.745	2.900
124	DB4-124P	3.780	3.450	.575	.745	3.000
128	DB4-128P	3.880	3.550	.575	.745	3.100
132	DB4-132P	3.980	3.650	.575	.745	3.200
136	DB4-136P	4.080	3.750	.575	.745	3.300
140	DB4-140P	4.180	3.850	.575	.745	3.400
144	DB4-144P	4.280	3.950	.575	.745	3.500
148	DB4-148P	4.380	4.050	.575	.745	3.600
152	DB4-152P	4.480	4.150	.575	.745	3.700
156	DB4-156P	4.580	4.250	.575	.745	3.800
160	DB4-160P	4.680	4.350	.575	.745	3.900
164	DB4-164P	4.780	4.450	.575	.745	4.000
168	DB4-168P	4.880	4.550	.575	.745	4.100
172	DB4-172P	4.980	4.650	.575	.745	4.200
176	DB4-176P	5.080	4.750	.575	.745	4.300
180	DB4-180P	5.180	4.850	.575	.745	4.400
184	DB4-184P	5.280	4.950	.575	.745	4.500
188	DB4-188P	5.380	5.050	.575	.745	4.600
192	DB4-192P	5.480	5.150	.575	.745	4.700
196	DB4-196P	5.580	5.250	.575	.745	4.800
200	DB4-200P	5.680	5.350	.575	.745	4.900
204	DB4-204P	5.780	5.450	.575	.745	5.000
208	DB4-208P	5.880	5.550	.575	.745	5.100
212	DB4-212P	5.980	5.650	.575	.745	5.200
216	DB4-216P	6.080	5.750	.575	.745	5.300
220	DB4-220P	6.180	5.850	.575	.745	5.400

Number of Contacts	DB Number*	A Max.	B	C Max.	H Max.	AA
224	DB4-224P	6.280	5.950	.575	.745	5.500
228	DB4-228P	6.380	6.050	.575	.745	5.600
232	DB4-232P	6.480	6.150	.575	.745	5.700
236	DB4-236P	6.580	6.250	.575	.745	5.800
240	DB4-240P	6.680	6.350	.575	.745	5.900
244	DB4-244P	6.780	6.450	.575	.745	6.000
248	DB4-248P	6.880	6.550	.575	.745	6.100
252	DB4-252P	6.980	6.650	.575	.745	6.200
256	DB4-256P	7.080	6.750	.575	.745	6.300
260	DB4-260P	7.180	6.850	.575	.745	6.400
264	DB4-264P	7.280	6.950	.575	.745	6.500
268	DB4-268P	7.380	7.050	.575	.745	6.600
272	DB4-272P	7.480	7.150	.575	.745	6.700
276	DB4-276P	7.580	7.250	.575	.745	6.800
280	DB4-280P	7.680	7.350	.575	.745	6.900
284	DB4-284P	7.780	7.450	.575	.745	7.000
288	DB4-288P	7.780	7.550	.575	.745	7.100
292	DB4-292P	7.980	7.650	.575	.745	7.200
296	DB4-296P	8.080	7.750	.575	.745	7.300
300	DB4-300P	8.180	7.850	.575	.745	7.400
304	DB4-304P	8.280	7.950	.575	.745	7.500
308	DB4-308P	8.380	8.050	.575	.745	7.600
312	DB4-312P	8.480	8.150	.575	.745	7.700
316	DB4-316P	8.580	8.250	.575	.745	7.800
320	DB4-320P	8.680	8.350	.575	.745	7.900
324	DB4-324P	8.780	8.450	.575	.745	8.000
328	DB4-328P	8.880	8.550	.575	.745	8.100
332	DB4-332P	8.980	8.650	.575	.745	8.200
336	DB4-336P	9.080	8.750	.575	.745	8.300
340	DB4-340P	9.180	8.850	.575	.745	8.400
344	DB4-344P	9.280	8.950	.575	.745	8.500
348	DB4-348P	9.380	9.050	.575	.745	8.600
352	DB4-352P	9.480	9.150	.575	.745	8.700
356	DB4-356P	9.580	9.250	.575	.745	8.800
360	DB4-360P	9.680	9.350	.575	.745	8.900
364	DB4-364P	9.780	9.450	.575	.745	9.000
368	DB4-368P	9.880	9.550	.575	.745	9.100
372	DB4-372P	9.980	9.650	.575	.745	9.200
376	DB4-376P	10.080	9.750	.575	.745	9.300
380	DB4-380P	10.180	9.850	.575	.745	9.400
384	DB4-384P	10.280	9.950	.575	.745	9.500
388	DB4-388P	10.380	10.050	.575	.745	9.600
392	DB4-392P	10.480	10.150	.575	.745	9.700
396	DB4-396P	10.580	10.250	.575	.745	9.800
400	DB4-400P	10.680	10.350	.575	.745	9.900

*See How to Order, pages 5, 6 and 7

Low Mating Force input/output connector



MATES WITH MB AND PC SERIES CONNECTORS

Notes:

When mating with MB or PC connector, a total of .022 inch minimum radial pilot is available for connector body alignment.

All dimensions for reference only.

Crimp contact 10-502588-1 (tin plate), wire well size 22D, supplied with IO Connector Series assemblies. Optional noble metal termination plating available. See How to Order, page 8.

Polarization keys are not supplied as part of IO Connector Series assemblies. See How to Order, page 7 and further description, page 28.

** Locking Screws are not supplied as part of IO Connector Series assemblies. See How to Order, page 7 and further description, page 29.

Description	Contact Data			
	Termination Style Letter	Contact Part Number	J ±.020	K ±.002
Rear Removable Crimp Contact	C	10-502588-1	N/A	N/A
Round PCB Stud Solder Termination	P	10-502416-21	.145	.021
	P-(713)	10-502416-31	.060	.021
	P-(709)	10-502416-41	.335	.021

NOTE: Other variations available - see pages 7 and 8, or consult Sidney, NY.

Low Mating Force input/output connector 2 row contact arrangements

Number of Contacts	IO Number*	A Max.	B	C Max.
020	IO2-020(*)	2.295	1.975	.390
022	IO2-022(*)	2.395	2.075	.390
024	IO2-024(*)	2.495	2.175	.390
026	IO2-026(*)	2.595	2.275	.390
028	IO2-028(*)	2.695	2.375	.390
030	IO2-030(*)	2.795	2.475	.390
032	IO2-032(*)	2.895	2.575	.390
034	IO2-034(*)	2.995	2.675	.390
036	IO2-036(*)	3.095	2.775	.390
038	IO2-038(*)	3.195	2.875	.390
040	IO2-040(*)	3.295	2.975	.390
042	IO2-042(*)	3.395	3.075	.390
044	IO2-044(*)	3.495	3.175	.390
046	IO2-046(*)	3.595	3.275	.390
048	IO2-048(*)	3.695	3.375	.390
050	IO2-050(*)	3.795	3.475	.390
052	IO2-052(*)	3.895	3.575	.390
054	IO2-054(*)	3.995	3.675	.390
056	IO2-056(*)	4.095	3.775	.390
058	IO2-058(*)	4.195	3.875	.390
060	IO2-060(*)	4.295	3.975	.390
062	IO2-062(*)	4.395	4.075	.390
064	IO2-064(*)	4.495	4.175	.390
066	IO2-066(*)	4.595	4.275	.390
068	IO2-068(*)	4.695	4.375	.390
070	IO2-070(*)	4.795	4.475	.390
072	IO2-072(*)	4.895	4.575	.390
074	IO2-074(*)	4.995	4.675	.390
076	IO2-076(*)	5.095	4.775	.390
078	IO2-078(*)	5.195	4.875	.390
080	IO2-080(*)	5.295	4.975	.390
082	IO2-082(*)	5.395	5.075	.390
084	IO2-084(*)	5.495	5.175	.390
086	IO2-086(*)	5.595	5.275	.390
088	IO2-088(*)	5.695	5.375	.390
090	IO2-090(*)	5.795	5.475	.390
092	IO2-092(*)	5.895	5.575	.390
094	IO2-094(*)	5.995	5.675	.390
096	IO2-096(*)	6.095	5.775	.390
098	IO2-098(*)	6.195	5.875	.390
100	IO2-100(*)	6.295	5.975	.390
102	IO2-102(*)	6.395	6.075	.390
104	IO2-104(*)	6.495	6.175	.390
106	IO2-106(*)	6.595	6.275	.390
108	IO2-108(*)	6.695	6.375	.390
110	IO2-110(*)	6.795	6.475	.390

Number of Contacts	IO Number*	A Max.	B	C Max.
112	IO2-112(*)	6.895	6.575	.390
114	IO2-114(*)	6.995	6.675	.390
116	IO2-116(*)	7.095	6.775	.390
118	IO2-118(*)	7.195	6.875	.390
120	IO2-120(*)	7.295	6.975	.390
122	IO2-122(*)	7.395	7.075	.390
124	IO2-124(*)	7.495	7.175	.390
126	IO2-126(*)	7.595	7.275	.390
128	IO2-128(*)	7.695	7.375	.390
130	IO2-130(*)	7.795	7.475	.390
132	IO2-132(*)	7.895	7.575	.390
134	IO2-134(*)	7.995	7.675	.390
136	IO2-136(*)	8.095	7.775	.390
138	IO2-138(*)	8.195	7.875	.390
140	IO2-140(*)	8.295	7.975	.390
142	IO2-142(*)	8.395	8.075	.390
144	IO2-144(*)	8.495	8.175	.390
146	IO2-146(*)	8.595	8.275	.390
148	IO2-148(*)	8.695	8.375	.390
150	IO2-150(*)	8.795	8.475	.390
152	IO2-152(*)	8.895	8.575	.390
154	IO2-154(*)	8.995	8.675	.390
156	IO2-156(*)	9.095	8.775	.390
158	IO2-158(*)	9.195	8.875	.390
160	IO2-160(*)	9.295	8.975	.390
162	IO2-162(*)	9.395	9.075	.390
164	IO2-164(*)	9.495	9.175	.390
166	IO2-166(*)	9.595	9.275	.390
168	IO2-168(*)	9.695	9.375	.390
170	IO2-170(*)	9.795	9.475	.390
172	IO2-172(*)	9.895	9.575	.390
174	IO2-174(*)	9.995	9.675	.390
176	IO2-176(*)	10.095	9.775	.390
178	IO2-178(*)	10.195	9.875	.390
180	IO2-180(*)	10.295	9.975	.390
182	IO2-182(*)	10.395	10.075	.390
184	IO2-184(*)	10.495	10.175	.390
186	IO2-186(*)	10.595	10.275	.390
188	IO2-188(*)	10.695	10.375	.390
190	IO2-190(*)	10.795	10.475	.390
192	IO2-192(*)	10.895	10.575	.390
194	IO2-194(*)	10.995	10.675	.390
196	IO2-196(*)	11.095	10.775	.390
198	IO2-198(*)	11.195	10.875	.390
200	IO2-200(*)	11.295	10.975	.390

*See How to Order, pages 5, 6 and 7

Low Mating Force input/output connector 3 row contact arrangements

Number of Contacts	IO Number*	A Max.	B	C Max.
030	IO3-030(*)	2.295	1.975	.490
033	IO3-033(*)	2.395	2.075	.490
036	IO3-036(*)	2.495	2.175	.490
039	IO3-039(*)	2.595	2.275	.490
042	IO3-042(*)	2.695	2.375	.490
045	IO3-045(*)	2.795	2.475	.490
048	IO3-048(*)	2.894	2.575	.490
051	IO3-051(*)	2.995	2.675	.490
054	IO3-054(*)	3.095	2.775	.490
057	IO3-057(*)	3.195	2.875	.490
060	IO3-060(*)	3.295	2.975	.490
063	IO3-063(*)	3.395	3.075	.490
066	IO3-066(*)	3.495	3.175	.490
069	IO3-069(*)	3.595	3.275	.490
072	IO3-072(*)	3.695	3.375	.490
075	IO3-075(*)	3.795	3.475	.490
078	IO3-078(*)	3.895	3.575	.490
081	IO3-081(*)	3.995	3.675	.490
084	IO3-084(*)	4.095	3.775	.490
087	IO3-087(*)	4.195	3.875	.490
090	IO3-090(*)	4.295	3.975	.490
093	IO3-093(*)	4.395	4.075	.490
096	IO3-096(*)	4.495	4.175	.490
099	IO3-099(*)	4.595	4.275	.490
102	IO3-102(*)	4.695	4.375	.490
105	IO3-105(*)	4.795	4.475	.490
108	IO3-108(*)	4.895	4.575	.490
111	IO3-111(*)	4.995	4.675	.490
114	IO3-114(*)	5.095	4.775	.490
117	IO3-117(*)	5.195	4.875	.490
120	IO3-120(*)	5.295	4.975	.490
123	IO3-123(*)	5.395	5.075	.490
126	IO3-126(*)	5.495	5.175	.490
129	IO3-129(*)	5.595	5.275	.490
132	IO3-132(*)	5.695	5.375	.490
135	IO3-135(*)	5.795	5.475	.490
138	IO3-138(*)	5.895	5.575	.490
141	IO3-141(*)	5.995	5.675	.490
144	IO3-144(*)	6.095	5.775	.490
147	IO3-147(*)	6.195	5.875	.490
150	IO3-150(*)	6.295	5.975	.490
153	IO3-153(*)	6.395	6.075	.490
156	IO3-156(*)	6.495	6.175	.490
159	IO3-159(*)	6.595	6.275	.490
162	IO3-162(*)	6.695	6.375	.490
165	IO3-165(*)	6.795	6.475	.490

Number of Contacts	IO Number*	A Max.	B	C Max.
168	IO3-168(*)	6.895	6.575	.490
171	IO3-171(*)	6.995	6.675	.490
174	IO3-174(*)	7.095	6.775	.490
177	IO3-177(*)	7.195	6.875	.490
180	IO3-180(*)	7.295	6.975	.490
183	IO3-183(*)	7.395	7.075	.490
186	IO3-186(*)	7.495	7.175	.490
189	IO3-189(*)	7.595	7.275	.490
192	IO3-192(*)	7.695	7.375	.490
195	IO3-195(*)	7.795	7.475	.490
198	IO3-198(*)	7.895	7.575	.490
201	IO3-201(*)	7.995	7.675	.490
204	IO3-204(*)	8.095	7.775	.490
207	IO3-207(*)	8.195	7.875	.490
210	IO3-210(*)	8.295	7.975	.490
213	IO3-213(*)	8.395	8.075	.490
216	IO3-216(*)	8.495	8.175	.490
219	IO3-219(*)	8.595	8.275	.490
222	IO3-222(*)	8.695	8.375	.490
225	IO3-225(*)	8.795	8.475	.490
228	IO3-228(*)	8.895	8.575	.490
231	IO3-231(*)	8.995	8.675	.490
234	IO3-234(*)	9.095	8.775	.490
237	IO3-237(*)	9.195	8.875	.490
240	IO3-240(*)	9.295	8.975	.490
243	IO3-243(*)	9.395	9.075	.490
246	IO3-246(*)	9.495	9.175	.490
249	IO3-249(*)	9.595	9.275	.490
252	IO3-252(*)	9.695	9.375	.490
255	IO3-255(*)	9.795	9.475	.490
258	IO3-258(*)	9.895	9.575	.490
261	IO3-261(*)	9.995	9.675	.490
264	IO3-264(*)	10.095	9.775	.490
267	IO3-267(*)	10.195	9.875	.490
270	IO3-270(*)	10.295	9.975	.490
273	IO3-273(*)	10.395	10.075	.490
276	IO3-276(*)	10.495	10.175	.490
279	IO3-279(*)	10.595	10.275	.490
282	IO3-282(*)	10.695	10.375	.490
285	IO3-285(*)	10.795	10.475	.490
288	IO3-288(*)	10.895	10.575	.490
291	IO3-291(*)	10.995	10.675	.490
294	IO3-294(*)	11.095	10.775	.490
297	IO3-297(*)	11.195	10.875	.490
300	IO3-300(*)	11.295	10.975	.490

*See How to Order, pages 5, 6 and 7

Low Mating Force input/output connector 4 row contact arrangements

Number of Contacts	IO Number*	A Max.	B	C Max.
040	IO4-040(*)	2.295	1.975	.590
044	IO4-044(*)	2.395	2.075	.590
048	IO4-048(*)	2.495	2.175	.590
052	IO4-052(*)	2.595	2.275	.590
056	IO4-056(*)	2.695	2.375	.590
060	IO4-060(*)	2.795	2.475	.590
064	IO4-064(*)	2.895	2.575	.590
068	IO4-068(*)	2.995	2.675	.590
072	IO4-072(*)	3.095	2.775	.590
076	IO4-076(*)	3.195	2.875	.590
080	IO4-080(*)	3.295	2.975	.590
084	IO4-084(*)	3.395	3.075	.590
088	IO4-088(*)	3.495	3.175	.590
092	IO4-092(*)	3.595	3.275	.590
096	IO4-096(*)	3.695	3.375	.590
100	IO4-100(*)	3.795	3.475	.590
104	IO4-104(*)	3.895	3.575	.590
108	IO4-108(*)	3.995	3.675	.590
112	IO4-112(*)	4.095	3.775	.590
116	IO4-116(*)	4.195	3.875	.590
120	IO4-120(*)	4.295	3.975	.590
124	IO4-124(*)	4.395	4.075	.590
128	IO4-128(*)	4.495	4.175	.590
132	IO4-132(*)	4.595	4.275	.590
136	IO4-136(*)	4.695	4.375	.590
140	IO4-140(*)	4.795	4.475	.590
144	IO4-144(*)	4.895	4.575	.590
148	IO4-148(*)	4.995	4.675	.590
152	IO4-152(*)	5.095	4.775	.590
156	IO4-156(*)	5.195	4.875	.590
160	IO4-160(*)	5.295	4.975	.590
164	IO4-164(*)	5.395	5.075	.590
168	IO4-168(*)	5.495	5.175	.590
172	IO4-172(*)	5.595	5.275	.590
176	IO4-176(*)	5.695	5.375	.590
180	IO4-180(*)	5.795	5.475	.590
184	IO4-184(*)	5.895	5.575	.590
188	IO4-188(*)	5.995	5.675	.590
192	IO4-192(*)	6.095	5.775	.590
196	IO4-196(*)	6.195	5.875	.590
200	IO4-200(*)	6.295	5.975	.590
204	IO4-204(*)	6.395	6.075	.590
208	IO4-208(*)	6.495	6.175	.590
212	IO4-212(*)	6.595	6.275	.590
216	IO4-216(*)	6.695	6.375	.590
220	IO4-220(*)	6.795	6.475	.590

Number of Contacts	IO Number*	A Max.	B	C Max.
224	IO4-224(*)	6.895	6.575	.590
228	IO4-228(*)	6.995	6.675	.590
232	IO4-232(*)	7.095	6.775	.590
236	IO4-236(*)	7.195	6.875	.590
240	IO4-240(*)	7.295	6.975	.590
244	IO4-244(*)	7.395	7.075	.590
248	IO4-248(*)	7.495	7.175	.590
252	IO4-252(*)	7.595	7.275	.590
256	IO4-256(*)	7.695	7.375	.590
260	IO4-260(*)	7.795	7.475	.590
264	IO4-264(*)	7.895	7.575	.590
268	IO4-268(*)	7.995	7.675	.590
272	IO4-272(*)	8.095	7.775	.590
276	IO4-276(*)	8.195	7.875	.590
280	IO4-280(*)	8.295	7.975	.590
284	IO4-284(*)	8.395	8.075	.590
288	IO4-288(*)	8.495	8.175	.590
292	IO4-292(*)	8.595	8.275	.590
296	IO4-296(*)	8.695	8.375	.590
300	IO4-300(*)	8.795	8.475	.590
304	IO4-304(*)	8.895	8.575	.590
308	IO4-308(*)	8.995	8.675	.590
312	IO4-312(*)	9.095	8.775	.590
316	IO4-316(*)	9.195	8.875	.590
320	IO4-320(*)	9.295	8.975	.590
324	IO4-324(*)	9.395	9.075	.590
328	IO4-328(*)	9.496	9.175	.590
332	IO4-332(*)	9.595	9.275	.590
336	IO4-336(*)	9.695	9.375	.590
340	IO4-340(*)	9.795	9.475	.590
344	IO4-344(*)	9.895	9.575	.590
348	IO4-348(*)	9.995	9.675	.590
352	IO4-352(*)	10.095	9.775	.590
356	IO4-356(*)	10.195	9.875	.590
360	IO4-360(*)	10.295	9.975	.590
364	IO4-364(*)	10.395	10.075	.590
368	IO4-368(*)	10.495	10.175	.590
372	IO4-372(*)	10.595	10.275	.590
376	IO4-376(*)	10.695	10.375	.590
380	IO4-380(*)	10.795	10.475	.590
384	IO4-384(*)	10.895	10.575	.590
388	IO4-388(*)	10.995	10.675	.590
392	IO4-392(*)	11.095	10.775	.590
396	IO4-396(*)	11.195	10.875	.590
400	IO4-400(*)	11.295	10.975	.590

*See How to Order, pages 5, 6 and 7

Low Mating Force PC connector

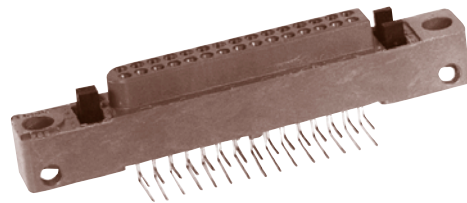
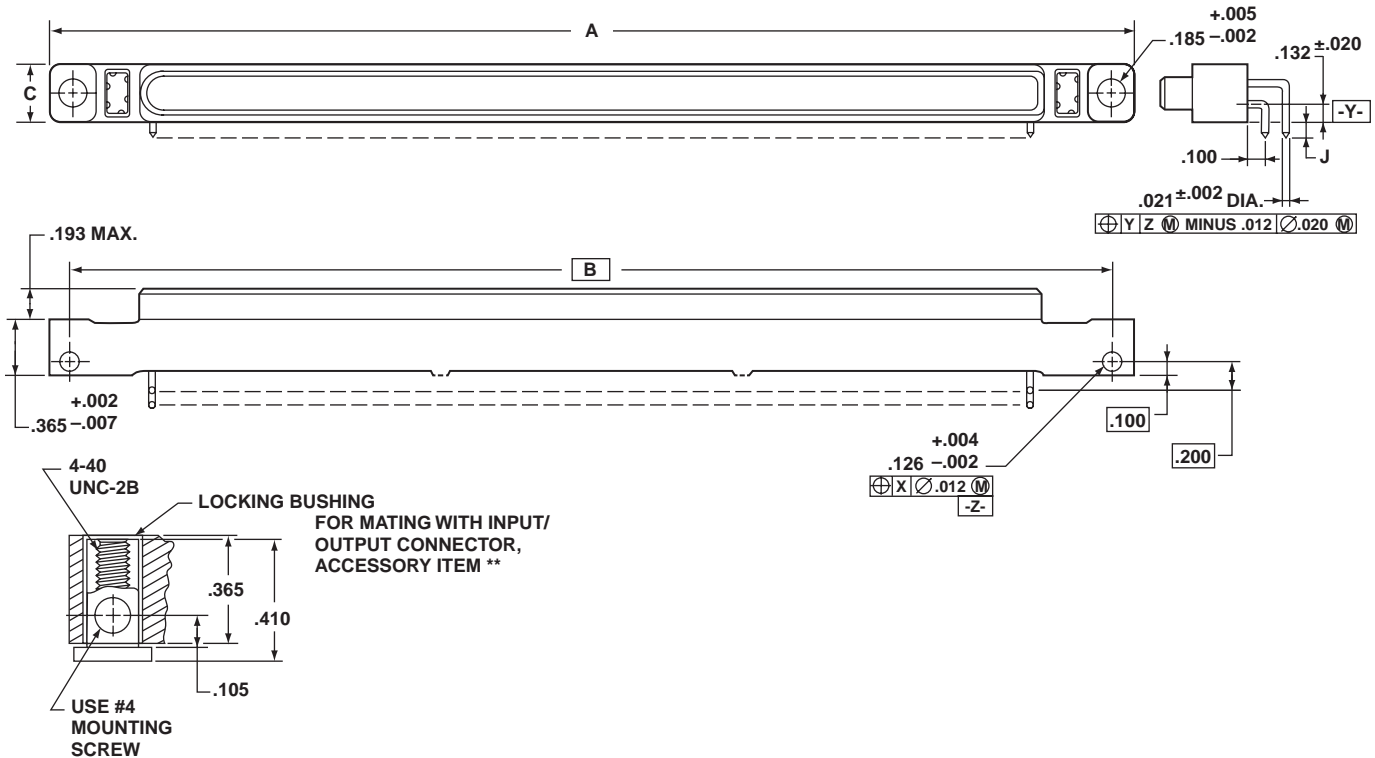

MATES WITH DB AND IO SERIES CONNECTORS

Notes:

When mating with DB connector, a total of .035 inch minimum radial pilot is available for connector body alignment.

All dimensions for reference only.

Polarization keys are not supplied as part of PC Connector Series assemblies. See How to Order, page 7 and further description, page 28.

** Not supplied as part of PC Connector Series assemblies. See How to Order, page 7, and further description, page 29.

□ Designates Basic Dimension

Contact Data

Description	Termination Style Letter	Arrangement Row	Contact Part Number	J +.035 -.025
Round PCB Stud, 90° Solder Termination	P	A	10-502409-11	.095
	P	B	10-502409-21	.095
	P	C	10-502409-41	.095
	P	D	10-502409-51	.095
	P-(714)	A	10-502409-61	.150
	P-(714)	B	10-502409-71	.150
	P-(714)	C	10-502409-81	.150
	P-(714)	D	10-502409-91	.150

NOTE: Other variations available - see pages 7 and 8, or consult Sidney, NY.

Low Mating Force PC connector 2 row contact arrangements

Number of Contacts	PC Number*	A Max.	B	C Max.
020	PC2-020P	2.295	1.975	.390
022	PC2-022P	2.395	2.075	.390
024	PC2-024P	2.495	2.175	.390
026	PC2-026P	2.595	2.275	.390
028	PC2-028P	2.695	2.375	.390
030	PC2-030P	2.795	2.475	.390
032	PC2-032P	2.895	2.575	.390
034	PC2-034P	2.995	2.675	.390
036	PC2-036P	3.095	2.775	.390
038	PC2-038P	3.195	2.875	.390
040	PC2-040P	3.295	2.975	.390
042	PC2-042P	3.395	3.075	.390
044	PC2-044P	3.495	3.175	.390
046	PC2-046P	3.595	3.275	.390
048	PC2-048P	3.695	3.375	.390
050	PC2-050P	3.795	3.475	.390
052	PC2-052P	3.895	3.575	.390
054	PC2-054P	3.995	3.675	.390
056	PC2-056P	4.095	3.775	.390
058	PC2-058P	4.195	3.875	.390
060	PC2-060P	4.295	3.975	.390
062	PC2-062P	4.395	4.075	.390
064	PC2-064P	4.495	4.175	.390
066	PC2-066P	4.595	4.275	.390
068	PC2-068P	4.695	4.375	.390
070	PC2-070P	4.795	4.475	.390
072	PC2-072P	4.895	4.575	.390
074	PC2-074P	4.995	4.675	.390
076	PC2-076P	5.095	4.775	.390
078	PC2-078P	5.195	4.875	.390
080	PC2-080P	5.295	4.975	.390
082	PC2-082P	5.395	5.075	.390
084	PC2-084P	5.495	5.175	.390
086	PC2-086P	5.595	5.275	.390
088	PC2-088P	5.695	5.375	.390
090	PC2-090P	5.795	5.475	.390
092	PC2-092P	5.895	5.575	.390
094	PC2-094P	5.995	5.675	.390
096	PC2-096P	6.095	5.775	.390
098	PC2-098P	6.195	5.875	.390
100	PC2-100P	6.295	5.975	.390
102	PC2-102P	6.395	6.075	.390
104	PC2-104P	6.495	6.175	.390
106	PC2-106P	6.595	6.275	.390
108	PC2-108P	6.695	6.375	.390
110	PC2-110P	6.795	6.475	.390

Number of Contacts	PC Number*	A Max.	B	C Max.
112	PC2-112P	6.895	6.575	.390
114	PC2-114P	6.995	6.675	.390
116	PC2-116P	7.095	6.775	.390
118	PC2-118P	7.195	6.875	.390
120	PC2-120P	7.295	6.975	.390
122	PC2-122P	7.395	7.075	.390
124	PC2-124P	7.495	7.175	.390
126	PC2-126P	7.595	7.275	.390
128	PC2-128P	7.695	7.375	.390
130	PC2-130P	7.795	7.475	.390
132	PC2-132P	7.895	7.575	.390
134	PC2-134P	7.995	7.675	.390
136	PC2-136P	8.095	7.775	.390
138	PC2-138P	8.195	7.875	.390
140	PC2-140P	8.295	7.975	.390
142	PC2-142P	8.395	8.075	.390
144	PC2-144P	8.495	8.175	.390
146	PC2-146P	8.595	8.275	.390
148	PC2-148P	8.695	8.375	.390
150	PC2-150P	8.795	8.475	.390
152	PC2-152P	8.895	8.575	.390
154	PC2-154P	8.995	8.675	.390
156	PC2-156P	9.095	8.775	.390
158	PC2-158P	9.195	8.875	.390
160	PC2-160P	9.295	8.975	.390
162	PC2-162P	9.395	9.075	.390
164	PC2-164P	9.495	9.175	.390
166	PC2-166P	9.595	9.275	.390
168	PC2-168P	9.695	9.375	.390
170	PC2-170P	9.795	9.475	.390
172	PC2-172P	9.895	9.575	.390
174	PC2-174P	9.995	9.675	.390
176	PC2-176P	10.095	9.775	.390
178	PC2-178P	10.195	9.875	.390
180	PC2-180P	10.295	9.975	.390
182	PC2-182P	10.395	10.075	.390
184	PC2-184P	10.495	10.175	.390
186	PC2-186P	10.595	10.275	.390
188	PC2-188P	10.695	10.375	.390
190	PC2-190P	10.795	10.475	.390
192	PC2-192P	10.895	10.575	.390
194	PC2-194P	10.995	10.675	.390
196	PC2-196P	11.095	10.775	.390
198	PC2-198P	11.195	10.875	.390
200	PC2-200P	11.295	10.975	.390

*See How to Order, pages 5, 6 and 7

Low Mating Force PC connector 3 row contact arrangements

Number of Contacts	PC Number*	A Max.	B	C Max.
030	PC3-030P	2.295	1.975	.490
033	PC3-033P	2.395	2.075	.490
036	PC3-036P	2.495	2.175	.490
039	PC3-039P	2.595	2.275	.490
042	PC3-042P	2.695	2.375	.490
045	PC3-045P	2.795	2.475	.490
048	PC3-048P	2.895	2.575	.490
051	PC3-051P	2.995	2.675	.490
054	PC3-054P	3.095	2.775	.490
057	PC3-057P	3.195	2.875	.490
060	PC3-060P	3.295	2.975	.490
063	PC3-063P	3.395	3.075	.490
066	PC3-066P	3.495	3.175	.490
069	PC3-069P	3.595	3.275	.490
072	PC3-072P	3.695	3.375	.490
075	PC3-075P	3.795	3.475	.490
078	PC3-078P	3.895	3.575	.490
081	PC3-081P	3.995	3.675	.490
084	PC3-084P	4.095	3.775	.490
087	PC3-087P	4.195	3.875	.490
090	PC3-090P	4.295	3.975	.490
093	PC3-093P	4.395	4.075	.490
096	PC3-096P	4.495	4.175	.490
099	PC3-099P	4.595	4.275	.490
102	PC3-102P	4.695	4.375	.490
105	PC3-105P	4.795	4.475	.490
108	PC3-108P	4.895	4.575	.490
111	PC3-111P	4.995	4.675	.490
114	PC3-114P	5.095	4.775	.490
117	PC3-117P	5.195	4.875	.490
120	PC3-120P	5.295	4.975	.490
123	PC3-123P	5.395	5.075	.490
126	PC3-126P	5.495	5.175	.490
129	PC3-129P	5.595	5.275	.490
132	PC3-132P	5.695	5.375	.490
135	PC3-135P	5.795	5.475	.490
138	PC3-138P	5.895	5.575	.490
141	PC3-141P	5.995	5.675	.490
144	PC3-144P	6.095	5.775	.490
147	PC3-147P	6.195	5.875	.490
150	PC3-150P	6.295	5.975	.490
153	PC3-153P	6.395	6.075	.490
156	PC3-156P	6.495	6.175	.490
159	PC3-159P	6.595	6.275	.490
162	PC3-162P	6.695	6.375	.490
165	PC3-165P	6.795	6.475	.490

Number of Contacts	PC Number*	A Max.	B	C Max.
168	PC3-168P	6.895	6.575	.490
171	PC3-171P	6.995	6.675	.490
174	PC3-174P	7.095	6.775	.490
177	PC3-177P	7.195	6.875	.490
180	PC3-180P	7.295	6.975	.490
183	PC3-183P	7.395	7.075	.490
186	PC3-186P	7.495	7.175	.490
189	PC3-189P	7.595	7.275	.490
192	PC3-192P	7.695	7.375	.490
195	PC3-195P	7.795	7.475	.490
198	PC3-198P	7.895	7.575	.490
201	PC3-201P	7.995	7.675	.490
204	PC3-204P	8.095	7.775	.490
207	PC3-207P	8.195	7.875	.490
210	PC3-210P	8.295	7.975	.490
213	PC3-213P	8.395	8.075	.490
216	PC3-216P	8.495	8.175	.490
219	PC3-219P	8.595	8.275	.490
222	PC3-222P	8.695	8.375	.490
225	PC3-225P	8.795	8.475	.490
228	PC3-228P	8.895	8.575	.490
231	PC3-231P	8.995	8.675	.490
234	PC3-234P	9.095	8.775	.490
237	PC3-237P	9.195	8.875	.490
240	PC3-240P	9.295	8.975	.490
243	PC3-243P	9.395	9.075	.490
246	PC3-246P	9.495	9.175	.490
249	PC3-249P	9.595	9.275	.490
252	PC3-252P	9.695	9.375	.490
255	PC3-255P	9.795	9.475	.490
258	PC3-258P	9.895	9.575	.490
261	PC3-261P	9.995	9.675	.490
264	PC3-264P	10.095	9.775	.490
267	PC3-267P	10.195	9.875	.490
270	PC3-270P	10.295	9.975	.490
273	PC3-273P	10.395	10.075	.490
276	PC3-276P	10.495	10.175	.490
279	PC3-279P	10.595	10.275	.490
282	PC3-282P	10.695	10.375	.490
285	PC3-285P	10.795	10.475	.490
288	PC3-288P	10.895	10.575	.490
291	PC3-291P	10.995	10.675	.490
294	PC3-294P	11.095	10.775	.490
297	PC3-297P	11.195	10.875	.490
300	PC3-300P	11.295	10.975	.490

*See How to Order, pages 5, 6 and 7

Low Mating Force PC connector 4 row contact arrangements

Number of Contacts	PC Number*	A Max.	B	C Max.
040	PC4-040P	2.295	1.975	.590
044	PC4-044P	2.395	2.075	.590
048	PC4-048P	2.495	2.175	.590
052	PC4-052P	2.595	2.275	.590
056	PC4-056P	2.695	2.375	.590
060	PC4-060P	2.795	2.475	.590
064	PC4-064P	2.895	2.575	.590
068	PC4-068P	2.995	2.675	.590
072	PC4-072P	3.095	2.775	.590
076	PC4-076P	3.195	2.875	.590
080	PC4-080P	3.295	2.975	.590
084	PC4-084P	3.395	3.075	.590
088	PC4-088P	3.495	3.175	.590
092	PC4-092P	3.595	3.275	.590
096	PC4-096P	3.695	3.375	.590
100	PC4-100P	3.795	3.475	.590
104	PC4-104P	3.895	3.575	.590
108	PC4-108P	3.995	3.675	.590
112	PC4-112P	4.095	3.775	.590
116	PC4-116P	4.195	3.875	.590
120	PC4-120P	4.295	3.975	.590
124	PC4-124P	4.395	4.075	.590
128	PC4-128P	4.495	4.175	.590
132	PC4-132P	4.595	4.275	.590
136	PC4-136P	4.695	4.375	.590
140	PC4-140P	4.795	4.475	.590
144	PC4-144P	4.895	4.575	.590
148	PC4-148P	4.995	4.675	.590
152	PC4-152P	5.095	4.775	.590
156	PC4-156P	5.195	4.875	.590
160	PC4-160P	5.295	4.975	.590
164	PC4-164P	5.395	5.075	.590
168	PC4-168P	5.495	5.175	.590
172	PC4-172P	5.595	5.275	.590
176	PC4-176P	5.695	5.375	.590
180	PC4-180P	5.795	5.475	.590
184	PC4-184P	5.895	5.575	.590
188	PC4-188P	5.995	5.675	.590
192	PC4-192P	6.095	5.775	.590
196	PC4-196P	6.195	5.875	.590
200	PC4-200P	6.295	5.975	.590
204	PC4-204P	6.395	6.075	.590
208	PC4-208P	6.495	6.175	.590
212	PC4-212P	6.595	6.275	.590
216	PC4-216P	6.695	6.375	.590
220	PC4-220P	6.795	6.475	.590

Number of Contacts	PC Number*	A Max.	B	C Max.
224	PC4-224P	6.895	6.575	.590
228	PC4-228P	6.995	6.675	.590
232	PC4-232P	7.095	6.775	.590
236	PC4-236P	7.195	6.875	.590
240	PC4-240P	7.295	6.975	.590
244	PC4-244P	7.395	7.075	.590
248	PC4-248P	7.495	7.175	.590
252	PC4-252P	7.595	7.275	.590
256	PC4-256P	7.695	7.375	.590
260	PC4-260P	7.795	7.475	.590
264	PC4-264P	7.895	7.575	.590
268	PC4-268P	7.995	7.675	.590
272	PC4-272P	8.095	7.775	.590
276	PC4-276P	8.195	7.875	.590
280	PC4-280P	8.295	7.975	.590
284	PC4-284P	8.395	8.075	.590
288	PC4-288P	8.495	8.175	.590
292	PC4-292P	8.595	8.275	.590
296	PC4-296P	8.695	8.375	.590
300	PC4-300P	8.795	8.475	.590
304	PC4-304P	8.895	8.575	.590
308	PC4-308P	8.995	8.675	.590
312	PC4-312P	9.095	8.775	.590
316	PC4-316P	9.195	8.875	.590
320	PC4-320P	9.295	8.975	.590
324	PC4-324P	9.395	9.075	.590
328	PC4-328P	9.495	9.175	.590
332	PC4-332P	9.595	9.275	.590
336	PC4-336P	9.695	9.375	.590
340	PC4-340P	9.795	9.475	.590
344	PC4-344P	9.895	9.575	.590
348	PC4-348P	9.995	9.675	.590
352	PC4-352P	10.095	9.775	.590
356	PC4-356P	10.195	9.875	.590
360	PC4-360P	10.295	9.975	.590
364	PC4-364P	10.395	10.075	.590
368	PC4-368P	10.495	10.175	.590
372	PC4-372P	10.595	10.275	.590
376	PC4-376P	10.695	10.375	.590
380	PC4-380P	10.795	10.475	.590
384	PC4-384P	10.895	10.575	.590
388	PC4-388P	10.995	10.675	.590
392	PC4-392P	11.095	10.775	.590
396	PC4-396P	11.195	10.875	.590
400	PC4-400P	11.295	10.975	.590

*See How to Order, pages 5, 6 and 7

Low Mating Force — accessories polarization keys

Polarization Keys, 10-285422-2 are accessory items, ordered separately for MB, DB, IO and PC Series Low Mating Force Connectors. If used, 4 keys are required per connector half. See page 7 for ordering information.

Examples below show key locations for mating connector halves. The number or letter designations on all mating connectors are arranged so that the projecting keys on one relate to the same numbers or letters on the other. With the numbers or letters matching, the connector will mate.

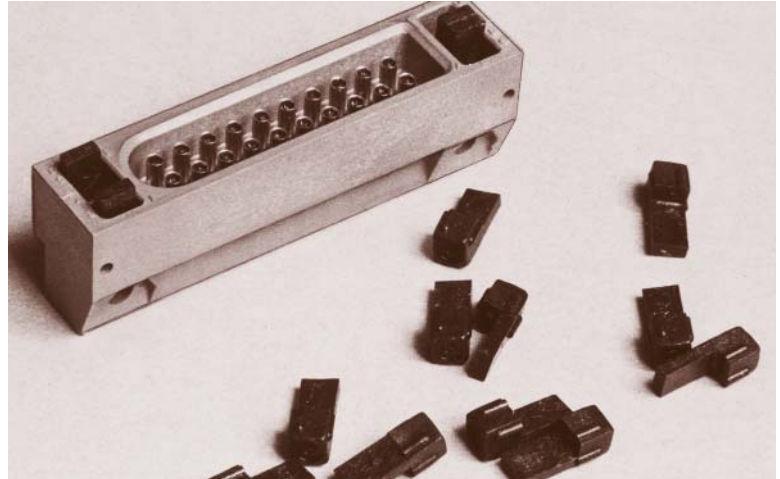

TYPICAL CODE SEQUENCE

B, H-1, 5

4 Different possibilities
at each position = 256

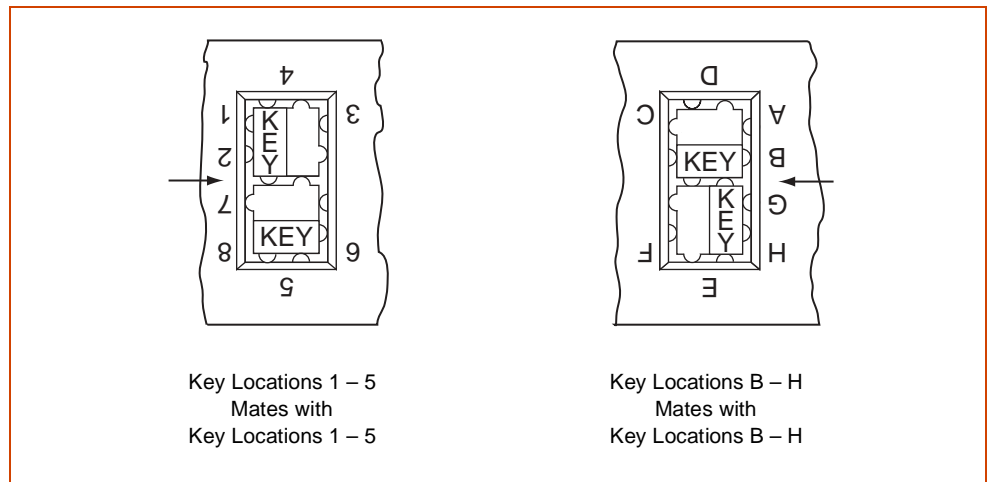

KEY LOCATIONS - MOTHER BOARD OR PC CONNECTORS

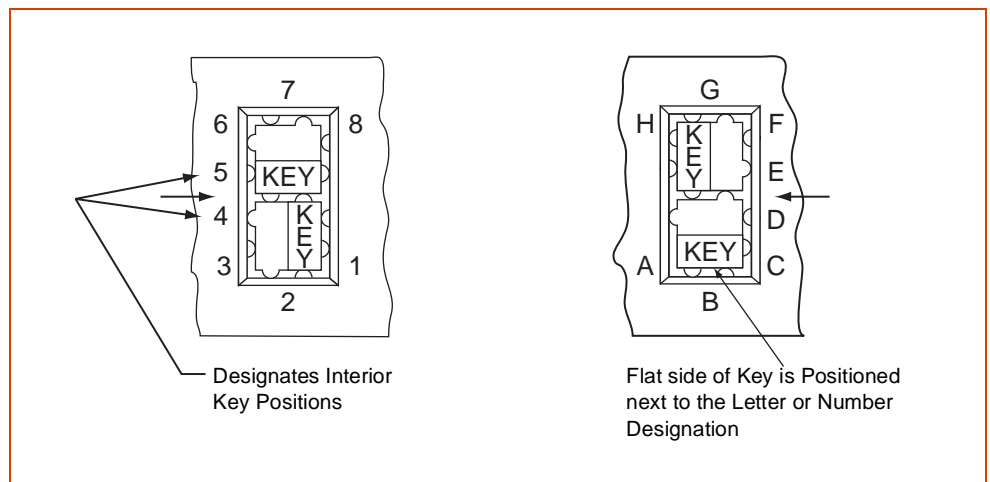

KEY LOCATIONS - DAUGHTER BOARD OR INPUT/OUTPUT CONNECTORS

Low Mating Force — accessories** mounting applications

INPUT/OUTPUT CONNECTOR

Locking screw accessory 10-502599*, two per connector, may be inserted into the large holes at each end of the back of an IO connector body. By hand, press the locking screw firmly down into the cavity until it reaches a positive stop. The locking screw is then captivated in the retention system of the cavity. Should it be necessary to remove the captivated locking screw accessory, push the screw as far forward as possible. Using vise grip pliers to grasp the threaded end and pliers to hold the knurled end, apply torque until the locking screw breaks in two. Each half will then drop out.

The front of the locking screw has a 4-40 UNC-2A THD which will mate with the locking bushing accessories of MB or PC connectors.

PC CONNECTOR

Locking bushing accessory 10-411196-4*, two per connector, may be inserted from the back of a PC connector body into large mounting holes at each end. The 0.126 inch diameter cross holes in the locking bushing must be aligned with the 0.126 inch diameter cross hole in the PC connector body. These holes accept a 4-40 UNC-2A screw which should be long enough to allow mounting to the board. Fasten with a suitable washer and nut, making sure an appropriate washer is also under the head.

The front of the locking bushing has a 4-40 UNC-2B THD which will mate with the locking bushing accessory of an IO connector.

MOTHER BOARD CONNECTOR

Locking/mounting bushing accessory 10-411196-3*, two per connector, may be inserted into 0.185 inch diameter CSK holes at each end of the front of a MB connector body. Using a light arbor press or similar device, firmly press the knurled section of the bushing into the lower 0.122 inch diameter hole until the front of the bushing is flush with, or slightly below, the front surface of the MB connector. Make sure the bushing and hole axis are properly aligned. Avoid excessive force which may crack the back surface of the MB connector body.

The back of the locking/mounting bushing has a 4-40 UNC-2A THD to mount the connector. Fasten the connector with a suitable washer and nut.

The front of the locking/mounting bushing has a 4-40 UNC-2B THD which will mate with the locking screw accessory of an IO connector.

Alternate Mounting Variations for Mother Board Connector

1. A clinch nut (such as all ESNA 79NCFMA2-26 or equivalent) may be pressed from the front, knurled end first, through the 0.185 diameter CSK into the 0.122 inch diameter hole at each end of the connector. An appropriate length 2-56 UNC-3A screw, washer, and nut may be used to mount the connector. Mounting forces should be applied to the bushing toward the rear of the connector.

2. When a Daughter Board is mated use a 4-40 screw of appropriate length, with a suitable washer under the head. Insert the screw from the front of the connector through the 0.185 inch diameter CSK into the 0.122 inch diameter hole at each end of the connector and fasten with a suitable washer and nut.

For ordering information, see page 7.
**See L-1220 for additional information

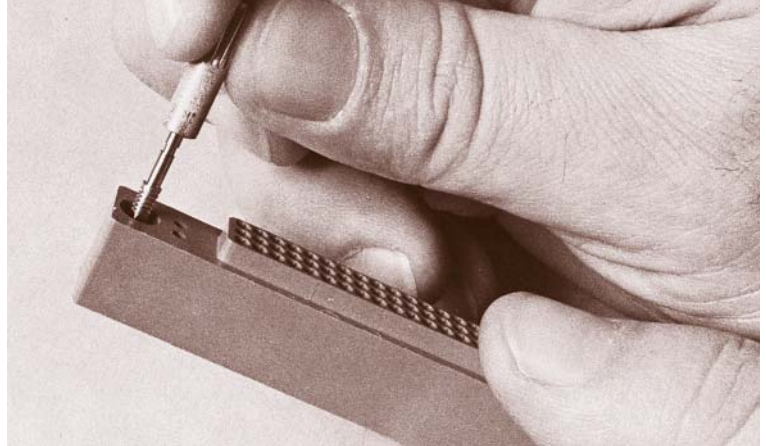

LOCKING SCREW ACCESSORY INSERTED INTO IO CONNECTOR BODY



LOCKING BUSHING ACCESSORY INSERTED INTO PC CONNECTOR BODY

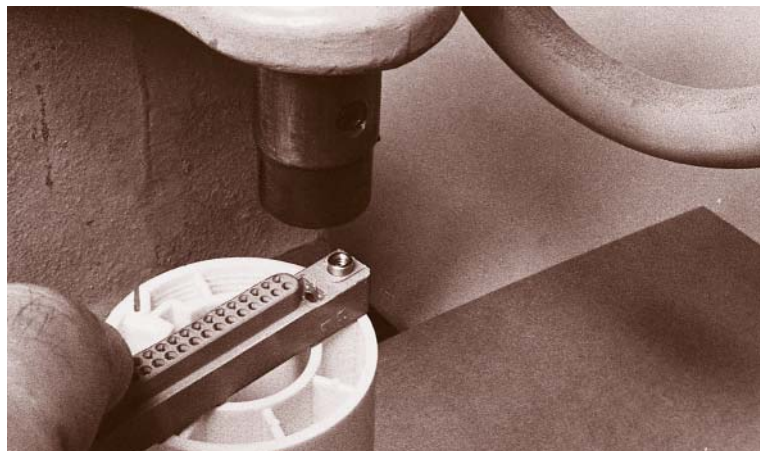

LOCKING/MOUNTING BUSHING ACCESSORY INSERTED INTO MB CONNECTOR BODY

Low Mating Force — accessories

test probe kit

In order to insure that contacts are properly wired within a connector, a Test probe Kit (11-10400-22)* is needed. This kit is especially designed to prevent damage to brush contacts during probing. It consists of a plastic holder, insert, and two contacts, usable for either Mother Board or Daughter Board applications. It is recommended that the user buy two kits, if using connectors of two genders. The kits are not convertible after assembly.

Instructions:

DB-IO Test Probe - Slide the insert back over the wire and crimp contact on. Follow crimping procedure below. Then snap the insert and contact assembly into the holder.

MB-PC Test probe - Slide holder over wire and then crimp contact. Follow crimping procedure below. Slide the insert on the contact and seat it against the shoulder. Slide the holder forward and snap it onto the insert.

Crimping Procedure: Using accepted industry procedures, strip wire end to be terminated 1/8 to 5/32 inch. Care should be taken not to nick wire strands. Assemble the M22520/2-01 crimp tool and the M22520/2-27 positioner, and place tool selector in correct setting for wire size. Selected wire size must not have an insulation diameter more than .062 for MB-PC and not more than .038 for DB/IO.

AWG	22	24	26	28
SEL	5	4	3	2

Insert stripped wire end into contact wire well. Strands should be visible in wire well inspection hole. Bottom contact and wire assembly in positioner, and close handles of crimp tool to complete crimp. Handles will not open unless full crimping cycle has been completed.

*For ordering information, see page 7.



DAUGHTER BOARD - INPUT/OUTPUT TEST PROBE



MOTHER BOARD - PC TEST PROBE

LRM Surface Mount Connectors with MIL-C-55302 Bristle® Brush® Contacts

Amphenol® LRM Surface Mount Connectors offer high performance and high contact density in a low insertion force PCB connector for today's integrated avionics packaging requirements.

Designed to meet the high density needs of today's integrated electronic modules, this surface mount connector uses the Brush® contact which has been proven in military avionics packages, is qualified to MIL-C-55302, and is the consensus choice for integrated avionics systems.

LRM Connector advantages include:

- **Low mating and unmating forces**
 - Smooth, low friction interfaces
 - 70% to 90% reduction in mating/unmating forces from conventional pin-socket contacts
- **Proven durability and long contact life**
 - Over 20,000 cycles of mating and unmating without performance degradation
 - Documented intermittency-free performance - no 10 nano second discontinuities during 50m cycles of 0.010 displacement
 - Overall cost effectiveness (reduced life cycle costs through extended service life)
- **Multiple points of contact provide superior electrical characteristics**
 - 14-70 points of contact per mated contact
 - Stable, low resistance
 - Redundant current paths
 - Proven electrical and gas tight contact sites
- **Surface/straddle mount module connectors; backplane connectors available with through-hole solder posts or compliant pins for solderless applications**

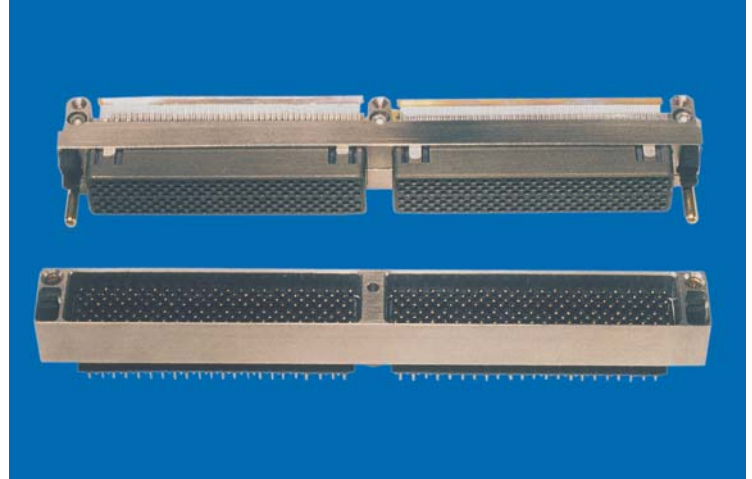

STAGGERED GRID, 360 CONTACTS LRM PATTERN



GEN-X GRID, 472 CONTACTS LRM PATTERN

Amphenol® LRM surface mount connectors are offered in configurations with up to 472 contacts in a SEM-E format and include ESD protection using the Faraday Cage principal. More contacts can be added to accommodate other formats. Other products available in the family are:

- RF module connectors for LRM applications requiring blind mate, radio frequency capability
- High-voltage inserts for LRM power supply applications designed to control the effects of high voltage at altitude
- Fiber optic configurations for high speed secure communications

For more information on surface mount connectors ask for L-2104 LRM Reference Guide, and/or L-2081 LRM User's Guide (contains engineering drawings). Consult Amphenol, Sidney, NY or your nearest Amphenol sales office.