

SERIES 42, 43, 44 and 54

1" Diameter, 1 Amp, Standard, Military SR04

FEATURES

- Rugged Construction Insures Switch Operation for the Life of Your Equipment
- Many Circuitry Options
- MIL Qualified Versions MIL-S-3786/04
- Features Choice Include: Shaft/ Panel Seal, Adjustable Stops, PC Termination, UL Recognized



DIMENSIONS In inches (and millimeters)

Standard, UL Recognized and Military Qualified Solder Lug Styles



Note: Common location for a single pole per deck switch. For common location on multi-pole switches, see circuit diagrams.

Rear Views

Series 42



Series 44



For rear view of 45°, 60° and 90°, see circuit diagram.

| No. of Decks | Dimension A | Dimension B | | Approx. Weight Grams | | No. of Decks | Dimension A | Dimension B | | Approx. Weight Grams | |
|--------------|---------------|-------------|--------------|----------------------|----|--------------|----------------|-------------|--------------|----------------------|-----|
| | | Style A | Style M or H | 42 | 44 | | | Style A | Style M or H | 42 | 44 |
| 1 | 1.025 (26,04) | .062 (1,57) | .030 (0,76) | 40.0 | 48 | 7 | 3.351 (85,16) | .312 (7,92) | .280 (7,11) | 73.0 | 90 |
| 2 | 1.371 (34,82) | .062 (1,57) | .030 (0,76) | 45.5 | 55 | 8 | 3.697 (93,90) | .312 (7,92) | .280 (7,11) | 78.5 | 97 |
| 3 | 1.717 (43,61) | .062 (1,57) | .030 (0,76) | 51.0 | 62 | 9 | 4.043 (102,69) | .312 (7,92) | .280 (7,11) | 84.0 | 104 |
| 4 | 2.063 (52,40) | .062 (1,57) | .030 (0,76) | 56.5 | 69 | 10 | 4.389 (111,48) | .312 (7,92) | .280 (7,11) | 89.5 | 111 |
| 5 | 2.409 (61,19) | .062 (1,57) | .030 (0,76) | 62.0 | 76 | 11 | 4.735 (120,27) | .312 (7,92) | .280 (7,11) | 95.0 | 118 |
| 6 | 3.005 (76,33) | .312 (7,92) | .280 (7,11) | 67.5 | 83 | 12 | 5.081 (129,06) | .312 (7,92) | .280 (7,11) | 100.5 | 125 |

Grayhill part number and date code marked on detent cover label. Customer part number marked on request. Military part number marked when required. UL recognized markings as required.

| Dimension | C | D | E | F |
|-----------|--------------|---------------|--------------|-------------|
| Series 42 | .562 (14,27) | 1.000 (25,4) | .830 (21,08) | .093 (2,36) |
| Series 44 | .642 (16,31) | 1.162 (29,51) | 1.000 (25,4) | .121 (3,07) |

CIRCUIT DIAGRAMS: Solder Lug Terminals

Switch is Viewed From Shaft End and Shown in Position No. 1

Note: All common terminals are located above base terminals as shown.

Series 44 & 54
30° Angle
of Throw



Series 42 & 43
36° Angle
of Throw



Series 44
45° Angle
of Throw



Series 44
60° Angle
of Throw

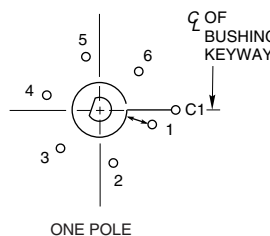

Series 44
90° Angle
of Throw

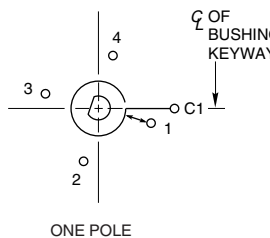

Rear Views



Rotary Switches

SERIES 42

1" Diameter, 1 Amp, PC Mount

FEATURES

- Satisfies High Current Board Level Applications
- 36° Angle of Throw Permits up to Ten Positions
- UL Recognized Versions



DIMENSIONS In inches (and millimeters)

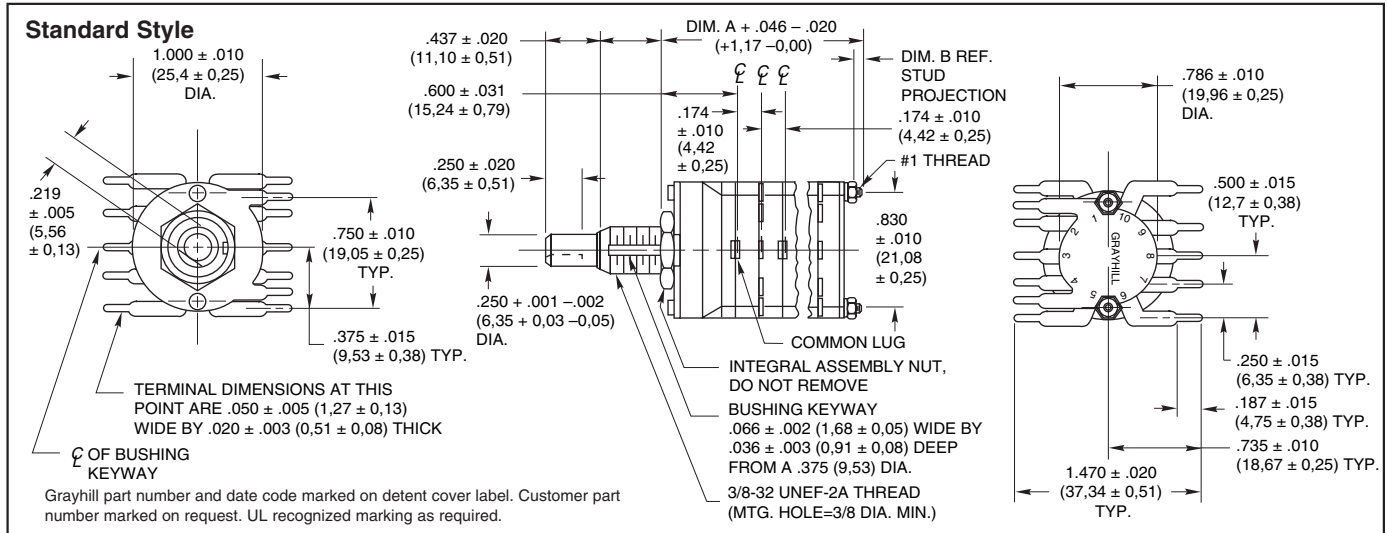

CIRCUIT DIAGRAM: PC Mount

Switch is Viewed From Shaft End and Shown in Position No. 1

Note: All common terminals are located above base terminals as shown.

Termination

One-sided termination is standard for switches with 2 to 5 positions per pole. Two-sided termination is standard for switches with 6 thru 10 positions per pole.

6 thru 10 positions per pole and terminals from one side of switch are available on special order. See Special Options, page F-10 or contact Grayhill.



PC BOARD MOUNTING PATTERN

Shown for a two deck switch

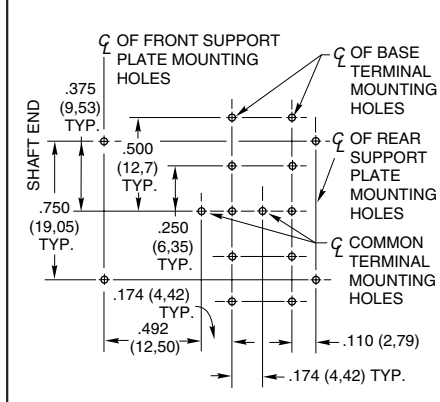

SHAFT AND PANEL SEAL: Srs. 42 & 44

Standard Style

The Series 42/44 Styles, which include the letter "S" with the exception of style "HS", are watertight sealed to the mounting panel by utilizing the panel seal kit. These switches are built with a front plate that does not have a non-turn tab. The panel seal kit consists of a grooved hex nut, a keyed washer and a keyed panel seal. The grooved hex nut is assembled to the switch bushing. The keyed washer is slid down the bushing slot and seated into the hex nut groove. The seal is likewise assembled to the bushing and hex nut. The keyed washer is required to provide seal integrity in the bushing slot. When assembled to the panel, the grooved nut, backing washer and seal require the same space as a normal mounting nut. Hence, the seal kit does not alter the dimensions. Panel seal kit includes a non-turn washer to be used into a blind hole in the back panel. For panel seal kit part dimensions, see Accessories. Style "HS" switches use a similar sealing method, except the integral assembly nut retains the panel seal. All sealed style switches are provided with a shaft to bushing internal seal.

ADJUSTABLE STOP SWITCHES: Series 42 and 44

The standard and UL recognized switches are also available with adjustable stops. Two removable stop washers allow you to limit the number of switch positions as needed. A knurled nut is supplied to secure the washers if desired. *These switches have no bushing keyway.* All other dimensions, ratings and characteristics are the same as the standard fixed stop styles. Although not military qualified, the adjustable styles are useful in military equipment prototypes. However, when submitting the equipment for government approval, the fixed stop qualified style should be substituted.

Equivalent Styles

- For style 42A36, use 42D36,
- For style 44A30, use 44D30
- For style 42M36, use 42D36 initially
- For style 44M30, use 44D30 initially
- For style 42U36, use 42UD36
- For style 44U30, use 44UD30

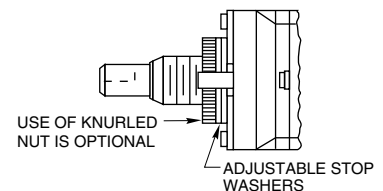
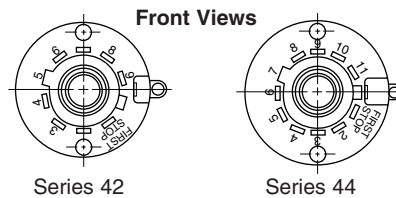

SERIES 43
SERIES 54
1" Diameter, 1 Amp, Concentric Shafts

FEATURES

- Two Switches in the Panel Space of a Single Shaft Rotary
- Military Qualified Versions MIL-3786/04
- Choice of 10 Positions (Series 43) or 12 Positions (Series 54)



DIMENSIONS In inches (and millimeters)

Standard Style and Military Qualified

Rear Views

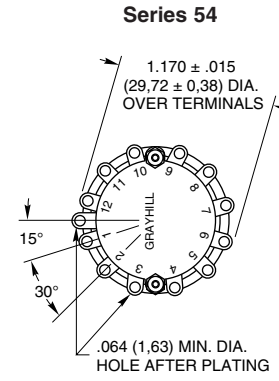

Note: Common location for a single pole per deck switch. For common location on multi-pole switches, see circuit diagrams.

| Number of Decks | | Dimension A | Dimension B | | Approx. Weight Grams | |
|-----------------|-------------|---------------|-----------------|-------------|----------------------|-----------|
| Section "A" | Section "B" | | Style A, M or H | Style A | Style M or H | Series 43 |
| 1 | 1 | 1.818 (46,18) | .062 (1,57) | .030 (0,76) | 48 | 60 |
| 2 | 1 | 2.164 (54,97) | .062 (1,57) | .030 (0,76) | 54 | 67 |
| 3 | 1 | 2.510 (63,75) | .062 (1,57) | .280 (7,11) | 60 | 74 |
| 1 | 2 | 2.164 (54,97) | .062 (1,57) | .030 (0,76) | 54 | 67 |
| 2 | 2 | 2.510 (63,75) | .062 (1,57) | .280 (7,11) | 60 | 74 |
| 3 | 2 | 3.105 (78,87) | .312 (7,92) | .280 (7,11) | 66 | 81 |
| 1 | 3 | 2.510 (63,75) | .062 (1,57) | .280 (7,11) | 60 | 74 |
| 2 | 3 | 3.105 (78,87) | .312 (7,92) | .280 (7,11) | 66 | 81 |
| 3 | 3 | 3.451 (87,66) | .312 (7,92) | .280 (7,11) | 72 | 88 |

Grayhill part number and date code marked on detent cover label. Customer part number marked on request. Military part number marked when required.

Rotary Switches

SERIES 43 and 54

1" Diameter, 1 Amp, Add-A-Pot

FEATURES

- Central Shaft Designed to Operate an Add-On Potentiometer
- Potentiometer Mounting Plates Provided
- Adjustable Stop Standard, Fixed Stop by Order
- Choice of 10 Positions (Series 43) or 12 Positions (Series 54)



DIMENSIONS In inches (and millimeters)

Standard Style

Rear Views

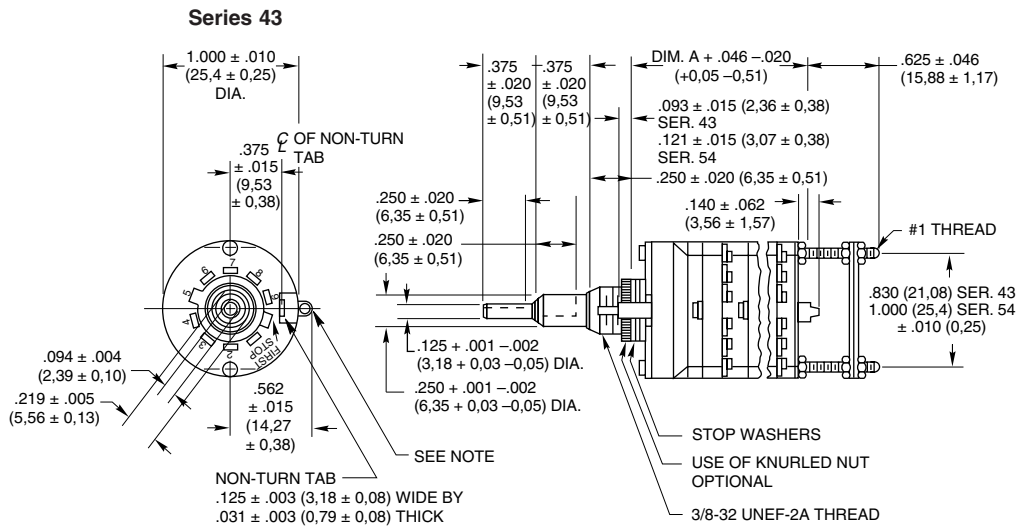

Note: Common location for a single pole per deck switch. For common location on multi-pole switches, see circuit diagrams.

| Number of Decks | Dimension A | Approx. Weight Grams | |
|-----------------|---------------|----------------------|-----------|
| | | Series 43 | Series 54 |
| 1 | .974 (24,74) | 48 | 60 |
| 2 | 1.320 (33,53) | 54 | 67 |
| 3 | 1.666 (42,32) | 60 | 74 |

Two potentiometer mounting plates are supplied. Mounting plates have .261 (6,63) and .380 (9,65) diameter holes respectively for mounting potentiometers with 1/4" and 3/8" bushings. Additional nuts for the through bolts of the switch are provided for adjustment of mounting plate location. Tapered tongue on 1/8" shaft provides coupling to screwdriver slots in potentiometer shafts.

Plated brass spacers for ease of positioning mounting plate driving assembly are available on special request (sold only with switches). The use of spacers is recommended for other than prototype requirements. When ordering switches with spacers, give full details regarding special length, potentiometer being used, etc.

Standard style, concentric shaft, add-a-pot switches have adjustable stops. See Adjustable Stop description.

Grayhill part number and date code marked on detent cover label. Customer part number marked on request. Military part number marked when required.

SERIES 54

1" Diameter, 1 Amp, Add-A-Pot

FEATURES

- Military Qualified MIL-3786/04
- Central Shaft Designed to Operate MIL Potentiometer
- Mounting Plate Options Provide Choice of Potentiometer
- Fixed Distance from Switch to Mounting Plate



DIMENSIONS In inches (and millimeters)

Military Qualified Style



Note: Common locations for a single pole per deck switch. For common location on multiple switches, see circuit diagram.

| Number of Decks | Dimension A | Approximate Weight Grams |
|-----------------|---------------|--------------------------|
| 1 | 1.024 (26,01) | 60 |
| 2 | 1.370 (34,80) | 67 |
| 3 | 1.716 (43,59) | 74 |

Series 54M Add-A-Pot Switch is a concentric shaft unit with provision for potentiometer mounting. Outer shaft operates switch decks. Inner shaft terminates in tapered tongue, which allows any desired potentiometer to be mounted. The Series 54M Add-A-Pot is qualified to MIL-DTL-3786/4-3. Patent No. 3,297,830.

Grayhill part number and date code marked on detent cover label. Customer part number marked on request. Military part number marked when required.

Potentiometer Mounting

The two mounting plates shown below are supplied with each switch.



Rotary Switches

MILITARY QUALIFIED

Single Shaft Switches

The military styles of the single shaft Series 42 and 44 rotary switches are qualified to MIL-DTL-3786/4, specifically SR04-1. Qualification includes two temperature ranges. Unsealed styles M, MB, MG and MBG are qualified for -65 to 85°C. Unsealed styles H, HB, HG and HBG, plus sealed styles HS, HBS, HGS and HBGS are qualified for -65°C to 125°C. Qualification includes low level switching and shaft grounding as specified in MIL-DTL-3786. Qualification includes 30°, 36°, 45°, 60° and 90° angles of throw with solder lug terminals. The military styles are dimensionally the same as the standard styles with two exceptions. The location of the common for the 3-pole switch differs (see circuit diagrams) and the non-turn tab for styles HS, HBS, HGS and HBGS differs per the Shaft and Panel Seal description following.

Two Switches, Concentric Shafts

The M style of the concentric shaft Series 43 and 54 switches is qualified to MIL-DTL-3786/4,

specifically SR04-2. Unsealed switches are qualified for -65°C to 85°C in 30°, 36°, 45°, 60° and 90° throws. The standard and military styles of the concentric switches have the same dimensions with the exception of the location of the 3 pole common (see circuit diagrams). The 30° and 36° throws are described in the ordering information. If the 45°, 60° and 90° throws are required, they can be provided in Section A of the Series 54 Rotary Switches; see Standard Options, page J-9.

Add-A-Pot Switches

The military style of the add-a-pot Series 54 switch is qualified to MIL-DTL-3786/4, specifically SR04-3. These unsealed switches are qualified for -65°C to 85°C in 30°, 45°, 60° and 90° throws. The dimensions of the military style add-a-pot switches are not the same as the standard add-a-pot switches; see drawings.

All Qualified Switches

Complete electrical ratings and characteristics for all of these qualified switches are listed on the

following pages. Standard variations such as terminals, shaft and/or bushing length etc., which do not affect performance, can be marked as qualified product. Adjustable stops cannot be qualified. Contact Grayhill for details about variations.

Military qualified switches may be ordered by the military M number listed in MIL-DTL-3786/4 or by the Grayhill part number. They will be marked to specifications.

MILITARY QUALIFIED SHAFT AND PANEL SEAL:

Styles HS, HBS, HGS and HBGS

The shaft is sealed to the bushing by an internal O-ring per MIL-P-5516B. The bushing is sealed to the panel with a silicone rubber washer and a stainless steel backing washer. The combined uncompressed thickness is 0.055" (1,40). Since this switch has a flat cover, a non-turn washer is supplied (see Panel Seal Kit). If using it, mount it in front of the panel.

SPECIFICATIONS:

Electrical Ratings

Standard Style

Rated: To make and break the following loads:

| | Angle of Throw | | |
|--------------------|----------------|------------|--------|
| | 30° or 36° | 45° or 60° | 90° |
| 115 Vac resistive | 1 amp | 5 amps | 5 amps |
| 6-28 Vdc resistive | 1 amp | 1 amp | 2 amps |
| 115 Vac inductive | 0.25 amp | 2 amps | 2 amps |
| 115 Vdc inductive | 0.02 amp | — | — |
| 6-28 Vdc inductive | 0.10 amp | — | — |
| 115 Vdc resistive | 0.10 amp | — | — |

To carry 10 amps continuously.

Contact Resistance: 50 milliohms maximum

Insulation Resistance: 1,000 megaohms minimum

Voltage Breakdown: 1,000 Vac initially (500 Vac or better after most environmental tests)

Life Expectancy: 100,000 mechanical cycles of operation. *Note:* Actual life is determined by a number of factors, including electrical loading, rate of rotation and environment, as well as maximum voltage breakdown required at the end of life.

UL Recognition—

Styles UA, UD, UM, UP, US and USP

Grayhill styles A and M and their variations (D, P, S and SP) of the Series 42, 43, 44 and 54 rotary switches have been tested by Underwriters Laboratories. The letter U in the style indicates proper marking as required by Underwriters Laboratories. These switches are recognized under file number E35289. The UL rating for the Series 42, 43, 44 and 54 is as follows:

Electrical Parameters: style UA = 1.0 ampere at 125 Vac. Style UM = 1.0 ampere at 125 Vac and also .5 ampere at 125 Vac, inductive load, 0.75 to 0.8 power factor.

Rating based on the following criteria:

Overload: 50 operations at 150% rated AC load

Endurance: 6000 operations at the rated load with 1000 Vac dielectric strength before and after test

Temperature Rise: Not to exceed 30°C when carrying rated AC load after test.

Note: all dimensional drawings for the standard style Series 42, 43, 44 and 54 also apply to these switches, with the exception that switches are marked per specifications.

Electrical Ratings

Military Style

General Rating: This rating is based on standard Grayhill tests of the Military style switch done at ambient conditions. It is provided for comparison to the Standard Style switch.

Charts shown for non-shorting contacts (break

before make)

Voltage and Load: As listed in the chart One cycle is 360° rotation and a return through all switch positions to the starting position. The data for the curves was measured at sea level, 25°C and 68% relative humidity.

The Series 42, 43, 44 and 54, style M, H and HS switches are made to meet requirements of MIL-DTL-3786, style SR04. Diallyl phthalate molded parts and the design of internal switching elements provide exceptional performance.

Curves shown are typical load-life curves for Series 42, 43, 44 and 54, style M, H and HS switches with 30° or 36° angles of throw. They show the numbers of cycles of rotational life expectancy for the types of loads shown. Thus, with a 5 amp, 115 Vac resistive load, 10,000 cycles of life is expected. If the load is reduced to 3 amps, life is increased to 25,000 cycles. The larger angles of throw (45°, 60° or 90°) switch larger currents for a like number of cycles.

Life limiting or failure criteria for these curves are:

Contact Resistance: 50 milliohms maximum

Insulation Resistance: 1,000 megaohms minimum between mutually insulated parts

Voltage Breakdown: 1,000 Vac minimum between mutually insulated parts. These switches will carry 10 amps with maximum contact temperature rise of 20°C. Life can be predicted by Grayhill if less critical life characteristics, elevated temperature or reduced pressure is involved.

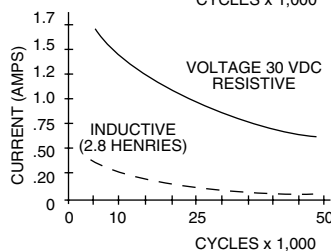
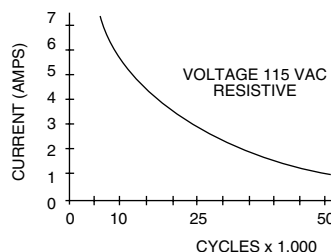

SPECIFICATIONS:

MIL-S-3786 Electrical Values**Military Style**

Style M switches, at 85°C, approximately 68% humidity and sea level pressure and style H and HS at 125°C have been tested to make and break the following loads as stated in MIL-DTL-3786/SR04; 250 milliamperes at 28 Vdc resistive, 100 milliamperes at 28 Vdc inductive (2.8 henries); 75 milliamperes at 115 Vac resistive.

These switches have also been tested at reduced barometric pressure (70,000 feet), 25°C at approximately 68% relative humidity to make and break the following loads as stated in MIL-DTL-3786/SR04; 200 milliamperes, 28 Vdc resistive; 25 milliamperes, 28 Vdc inductive (2.8 henries); 20 milliamperes, 115 Vac resistive. When tested to these loads and conditions the style M, H and HS switches meet the following life limiting or failure criteria after 25,000 cycles in accordance with MIL-S-3786.

Contact Resistance: 50 milliohms maximum

Insulation Resistance: 1,000 megaohms minimum between terminals and shafts

Dielectric Strength: 1,000 Vac (atmospheric pressure) and 450 Vac (reduced pressure) minimum between mutually insulated parts.

When tested at sea level 25°C and 68% relative humidity with failure criteria of 50 milliohms max. and 750 Vac breakdown voltage, these switches will make and break the following loads: 250 mA at 28 Vdc, inductive (2.8 henries); 1.25 amps at 28 Vdc resistive; 2.0 amps at 115 Vac, 60 Hz resistive, for 10,000 cycles.

These switches also meet MIL-DTL-3786/SR04 for moisture resistance, medium and high shock, vibration (10 to 2000 cps), thermal shock (-65°C to 125°C), salt spray, explosion and terminal pull.

Materials and Finishes**Standard Style**

Bases: Melamine per (MIL-M-14) ASTM-D-5948

Cover, Deck Separators, End Plate and Rotor Mounting Plate: Phenolic per (MIL-M-14) ASTM-D-5948

Mounting Bushings: Brass, tin/zinc-plated.

Shaft, Cover Plate, Retaining Rings, Through Bolts, Shaft Extensions, Stop Arm, Thrust Washers Stop Washers and Rear Support Plate: Stainless Steel

Detent Balls: Steel, nickel-plated

Detent Springs: Tinned music wire

Rotor Contact, Stator (Base) Contacts: Silver alloy

Terminals (Except Common): Brass, tin plated

Common Plate, Including Solder Lug: Brass, silver-plated .0003" minimum

Mounting Hardware: Two mounting nuts .094" (2,39) thick by .562" (14,27) across flats and one internal tooth lockwasher are supplied with each switch.

Stud Nuts, Mounting Nuts, Lock Washers: Tin/zinc-plated or stainless steel.

Materials and Finishes**Military Qualified**

Bases: Diallyl per (MIL-M-14) ASTM-D-5948

Cover, Deck Separators, End Plate and Rotor Mounting Plate: Diallyl per (MIL-M-14) ASTM-D-5948

Mounting Bushings: Brass, tin/zinc-plated.

Shaft, Cover Plate, Retaining Rings, Through Bolts, Shaft Extensions, Stop Arm, Stop Washers, Thrust Washers and Rear Support Plate: Stainless steel

Detent Balls: Steel, nickel-plated

Detent Springs: Tinned music wire

Rotor Contact: Silver alloy

Terminals, Common Plate including Solder Lug: Brass, silver-plated .0003" minimum

Mounting Hardware: Two mounting nuts .094" thick by .562" across flats and one internal tooth lockwasher are supplied with each switch.

Stud Nuts, Mounting Nuts, Lock Washers: Tin/zinc-plated or stainless steel.

Additional Characteristics**Standard Style and Military Qualified**

Contact: Shorting or non-shorting wiping contacts with over 150 grams of contact force

Rotational Torque: 8-115 ounce-inches depending upon the number of poles per deck, number of decks and angle of throw

Mechanical Life Expectancy: 100,000 cycles of operation

Shaft Flat Orientation: Flat opposite contacting position of pole number one (See circuit diagram).

Stop Strength: For Standard style: 15 pound-inches minimum. For Adjustable stop styles: 12 pound-inches

Extended Stud: Single shaft switches of six or more decks and concentric shaft switches of a combination of five or more decks (Standard style) or four or more decks (Military style) have longer studs with extra mounting nuts for recommended double end mount.

CHOICES AND LIMITATIONS: Series 42, 43, 44 and 54

A = Standard, Solder Lugs
 P = Standard, PC Mount Terminals
 D = Standard, Adjustable Stops

S = Shaft and Panel Seal
 U = UL Recognized
 M = Military Qualified 85°C⁴

H = Military Qualified, 125°C
 B = Military, Grounded Shaft
 G = Military, Low Level Rating

SINGLE SHAFT SWITCHES

| Series | Style Choices | | Angle of Throw | Number of Decks | Poles Per Deck | Positions Per Pole ^{1,3} | Shorting or Non-Shorting | | | |
|------------|--|--|----------------|-----------------|----------------|-----------------------------------|--------------------------|---|-------------------------|--------|
| | Unsealed | Shaft/Panel Seal | | | | | | | | |
| 42 | A UA UM ⁵ M MB MG MBG H HB HG HBG | S US — MS ⁴ MBS ⁴ MGS ⁴ MBGS ⁴ | 36° | 01 thru 12 | 1 | 02 thru 10 ³ | N or S | | | |
| | | | | 01 thru 12 | 2 | 02 thru 05 | N or S | | | |
| | | | 44 | — | — | 30° | 01 thru 12 | 1 | 02 thru 12 ³ | N or S |
| | | | | | | | 01 thru 12 | 2 | 02 thru 06 | N or S |
| | | | | | | | 01 thru 08 | 3 | 02 thru 04 | N or S |
| | | | | | | | 01 thru 06 | 4 | 02 or 03 | N or S |
| | | | | | | | 01 thru 04 | 5 | 02 | N or S |
| | | | | | | | 01 thru 04 | 6 | 02 | N or S |
| | | | 44 | — | — | 45° | 01 thru 12 | 1 | 02 thru 08 ³ | N or S |
| | | | | | | | 01 thru 06 | 2 | 02 thru 04 | N or S |
| 01 thru 04 | 3 | 02 | | | | | N | | | |
| 01 thru 03 | 4 | 02 | | | | | N | | | |
| 44 | — | — | 60° | 01 thru 12 | 1 | 02 thru 06 ³ | N | | | |
| | | | | 01 thru 06 | 2 | 02 or 03 | N | | | |
| | | | | 01 thru 04 | 3 | 02 | N | | | |
| 44 | D UD | — — | 30° | 01 thru 12 | 1 | AJ (2 thru 12) ¹ | N or S | | | |
| | | | | 01 thru 12 | 2 | AJ (2 thru 6) ¹ | N or S | | | |
| 42 | P UP | SP USP | 36° | 01 thru 08 | 3 | AJ (2 thru 4) ¹ | N or S | | | |
| | | | | 01 thru 06 | 4 | AJ (2 or 3) ¹ | N or S | | | |
| 42 | — | — | 36° | 01 thru 12 | 1 | AJ (2 thru 10) ¹ | N or S | | | |
| | | | | 01 thru 12 | 2 | AJ (2 thru 5) ¹ | N or S | | | |
| 42 | — | — | 36° | 01 thru 12 | 1 | 02 thru 10 ³ | N or S | | | |

Concentric Shaft Switches

| Series | Style Choices | Angle of Throw | Section A (Front) | | | | Section B (Rear) | | | | | | |
|-------------------------------------|---|----------------|--------------------------|-------------------------|-------------------------|------------|--|-------------------------|-------------------------|----------|---|------------|--------|
| | | | Decks | Poles | Position | N or S | Decks | Poles | Position | N or S | | | |
| CONCENTRIC SHAFT, 2 SWITCHES | | | | | | | | | | | | | |
| 54 | A ² UA ² M ² | 30° | 01 thru 03 01 thru 03 | 1 | 02 thru 12 ³ | N or S | 01 thru 03 | 1 | 02 thru 12 ³ | N or S | | | |
| | | | | 2 | 02 thru 06 | N or S | 01 thru 03 | 2 | 02 thru 06 | N or S | | | |
| | | | 43 | — | 36° | 01 thru 03 | 1 | 02 thru 10 ⁵ | N or S | 01 or 02 | 3 | 02 thru 04 | N or S |
| | | | | | | | 01 | 4 | 02 or 03 | N or S | | | |
| | | | | | | | 01 | 5 | 02 | N or S | | | |
| | | | | | | | 01 | 6 | 02 | N or S | | | |
| ADD-A-POT SWITCHES | | | | | | | | | | | | | |
| 54 | D UD | 30° | 01 thru 03 | 1 | AJ (2-12) ¹ | N or S | Second shaft operates a potentiometer supplied by the customer. Rear mounting plates are provided. | | | | | | |
| 01 thru 03 | | | 2 | AJ (2-6) ¹ | N or S | | | | | | | | |
| 43 | M | 36° | 01 thru 03 | 1 | AJ (2-10) ¹ | N or S | | | | | | | |
| 01 thru 03 | | | 2 | 02 thru 12 ⁵ | N or S | | | | | | | | |
| 54 | — | 30° | 01 thru 03 | 2 | 02 thru 06 | N or S | | | | | | | |

¹For Adjustable Stop (with the letter D), use AJ instead of number of positions when ordering.

²For 45°, 60° or 90° throws in Series 54 switches of these styles, see Standard Options.

³For single pole switches with the maximum positions per pole, continuous rotation is possible. Specify fixed stop or continuous rotation when ordering single shaft switches. Concentric shaft switches have continuous

rotation.

⁴Styles which include both M and S are not qualified but are made of the same materials and construction as qualified types. For qualified switches with shaft and panel seal, use equivalent HS style.

⁵UM switches are made of the same materials and construction as the M style switches. For military switch UM is not required; use M style.

ACCESSORIES

Internal Tooth Lockwasher—Figure A

For a 3/8" bushing. Approximately 0.500" (12,7) outside diameter, .022" (0,56) thickness. Material is cadmium-plated steel. Part No. **12Q1272-1**
 For a 1/4" bushing. Approximately 0.400" (10,16) outside diameter, .018" (0,46) thickness. Material is steel, tin/zinc plated.



FIGURE A

Non-Turn Washer—Figure B

Can be ordered as extra hardware for the Series 5000, 24, 42, 43, 44, 54, 71B, 53, 57 and 59 rotary switches. The internal key of the washer slides into the bushing keyway. The right angle tab locks into a predrilled hole on the back side of the mounting panel. Material is brass, tin/zinc plated. Part No. **12C1087-1**

bushing to the panel. The kit consists of four items: a grooved hex nut, a keyed washer, a keyed seal and a non-turn washer. Assembly is described on Page J-53. Dimensions of panel seal kit items are shown in Figure C. This kit seals the bushing to the panel; it does not seal the shaft to the bushing. Not usable with adjustable stop switches. Part No. **42-24**

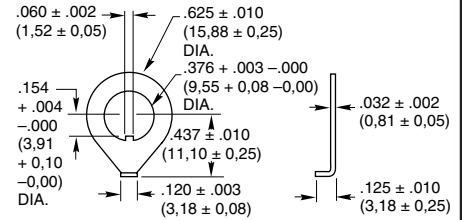

FIGURE B

Panel Seal Kit—Figure C

Sold as a separate item to seal the switch



FIGURE C

ORDERING INFORMATION: Single Shaft Switches, Add-A-Pot Switches



44M30-02-1-12N-F

- Series:** Determined by the type of switch and the angle of throw
- Style*:** Letter(s) from the Choices and Limitations chart
- Angle of Throw: Must agree with Series Number
- Number of Decks:** As limited by the angle of throw, the poles per deck, switch style and type of contacts
- Stop Arrangement:** Add letter F to a one pole per deck switch with the maximum number of positions for a stop between position 1 and the last position. Leave blank for continuous rotation
- Type of Contacts:** N = Non-shortening; S = Shortening
- Positions Per Pole:** Requires 02 positions as a minimum to maximum allowable dependent on the angle of throw and poles per deck. Use AJ for adjustable stops (Styles D and UD).
- Poles Per Deck:** As limited by angle of throw, switch series and style

* All rotary switches that are required to have military designated markings and testing adhering to MIL-3786 are to be ordered by specifying the military part number identified on the appropriate slash sheet.

ORDERING INFORMATION: Concentric Shaft Rotary Switches

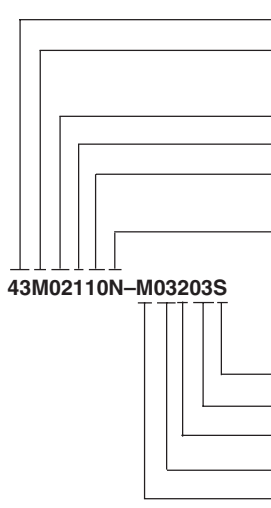

43M02110N-M03203S

- Series:** Determined by the angle of throw, applicable to both sections
- Style*:** Letter(s) from the Choices and Limitations chart
- Section A (front)**
- Number of Decks:** As limited by the number of poles per deck
- Poles Per Deck:** As limited by the angle of throw
- Positions Per Pole:** Requires 02 positions as a minimum to the maximum allowable dependent on the angle of throw and the poles per deck
- Type of Contacts:** N=Non-shortening, S=Shortening. All one pole per deck switches with the maximum number of positions are continuous rotation
- Section B (rear)**
- The limitations listed for Section A apply to Section B
- Type of Contacts**
- Positions Per Pole**
- Poles Per Deck**
- Number of Decks**
- Style**

* All rotary switches that are required to have military designated markings and testing adhering to MIL-3786 are to be ordered by specifying the military part number identified on the appropriate slash sheet.

Available from your local Grayhill Distributor For prices and discounts, contact a local Sales Office, an authorized local Distributor or Grayhill.